



STAGE KEYBOARD
CLAVIER DE SCÈNE
TECLADO DE ESCENARIO

YC61

OWNER'S MANUAL
MODE D'EMPLOI
MANUAL DE INSTRUCCIONES

English

Français

Español

EN

FR

ES

FCC INFORMATION (U.S.A.)

1. IMPORTANT NOTICE: DO NOT MODIFY THIS UNIT!

This product, when installed as indicated in the instructions contained in this manual, meets FCC requirements. Modifications not expressly approved by Yamaha may void your authority, granted by the FCC, to use the product.

2. IMPORTANT:

When connecting this product to accessories and/or another product use only high quality shielded cables. Cable/s supplied with this product MUST be used. Follow all installation instructions. Failure to follow instructions could void your FCC authorization to use this product in the USA.

3. NOTE:

This product has been tested and found to comply with the requirements listed in FCC Regulations, Part 15 for Class "B" digital devices. Compliance with these requirements provides a reasonable level of assurance that your use of this product in a residential environment will not result in harmful interference with other electronic devices. This equipment generates/uses radio frequencies and, if not installed and used according to the instructions found in the users manual, may cause interference harmful to the operation of other electronic devices. Compliance with FCC regula-

tions does not guarantee that interference will not occur in all installations. If this product is found to be the source of interference, which can be determined by turning the unit "OFF" and "ON", please try to eliminate the problem by using one of the following measures:

Relocate either this product or the device that is being affected by the interference.

Utilize power outlets that are on different branch (circuit breaker or fuse) circuits or install AC line filter/s.

In the case of radio or TV interference, relocate/reorient the antenna. If the antenna lead-in is 300 ohm ribbon lead, change the lead-in to co-axial type cable.

If these corrective measures do not produce satisfactory results, please contact the local retailer authorized to distribute this type of product. If you can not locate the appropriate retailer, please contact Yamaha Corporation of America, Electronic Service Division, 6600 Orangethorpe Ave, Buena Park, CA90620

The above statements apply ONLY to those products distributed by Yamaha Corporation of America or its subsidiaries.

* This applies only to products distributed by Yamaha Corporation of America.

(class B)

COMPLIANCE INFORMATION STATEMENT (Supplier's declaration of conformity procedure)

Responsible Party: Yamaha Corporation of America

Address: 6600 Orangethorpe Ave., Buena Park, Calif. 90620

Telephone: 714-522-9011

Type of Equipment: STAGE KEYBOARD

Model Name: YC61

This device complies with Part 15 of the FCC Rules.

Operation is subject to the following two conditions:

1) this device may not cause harmful interference, and

2) this device must accept any interference received including interference that may cause undesired operation.

* This applies only to products distributed by Yamaha Corporation of America.

(FCC SDoC)

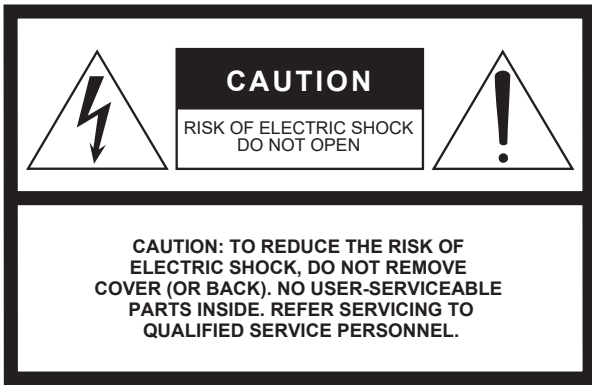

The above warning is located on the bottom of the unit.

Explanation of Graphical Symbols

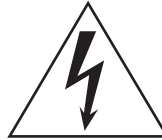

The lightning flash with arrowhead symbol within an equilateral triangle is intended to alert the user to the presence of uninsulated “dangerous voltage” within the product’s enclosure that may be of sufficient magnitude to constitute a risk of electric shock to persons.



The exclamation point within an equilateral triangle is intended to alert the user to the presence of important operating and maintenance (servicing) instructions in the literature accompanying the product.

IMPORTANT SAFETY INSTRUCTIONS

- 1 Read these instructions.
- 2 Keep these instructions.
- 3 Heed all warnings.
- 4 Follow all instructions.
- 5 Do not use this apparatus near water.
- 6 Clean only with dry cloth.
- 7 Do not block any ventilation openings. Install in accordance with the manufacturer’s instructions.
- 8 Do not install near any heat sources such as radiators, heat registers, stoves, or other apparatus (including amplifiers) that produce heat.
- 9 Do not defeat the safety purpose of the polarized or grounding-type plug. A polarized plug has two blades with one wider than the other. A grounding type plug has two blades and a third grounding prong. The wide blade or the third prong are provided for your safety. If the provided plug does not fit into your outlet, consult an electrician for replacement of the obsolete outlet.
- 10 Protect the power cord from being walked on or pinched particularly at plugs, convenience receptacles, and the point where they exit from the apparatus.
- 11 Only use attachments/accessories specified by the manufacturer.
- 12 Use only with the cart, stand, tripod, bracket, or table specified by the manufacturer, or sold with the apparatus. When a cart is used, use caution when moving the cart/apparatus combination to avoid injury from tip-over.
- 13 Unplug this apparatus during lightning storms or when unused for long periods of time.
- 14 Refer all servicing to qualified service personnel. Servicing is required when the apparatus has been damaged in any way, such as power-supply cord or plug is damaged, liquid has been spilled or objects have fallen into the apparatus, the apparatus has been exposed to rain or moisture, does not operate normally, or has been dropped.



WARNING

TO REDUCE THE RISK OF FIRE OR ELECTRIC SHOCK, DO NOT EXPOSE THIS APPARATUS TO RAIN OR MOISTURE.

(UL60065_03)

Information for users on collection and disposal of old equipment:



This symbol on the products, packaging, and/or accompanying documents means that used electrical and electronic products should not be mixed with general household waste. For proper treatment, recovery and recycling of old products, please take them to applicable collection points, in accordance with your national legislation.

By disposing of these products correctly, you will help to save valuable resources and prevent any potential negative effects on human health and the environment which could otherwise arise from inappropriate waste handling.

For more information about collection and recycling of old products, please contact your local municipality, your waste disposal service or the point of sale where you purchased the items.

For business users in the European Union:

If you wish to discard electrical and electronic equipment, please contact your dealer or supplier for further information.

Information on Disposal in other Countries outside the European Union:

This symbol is only valid in the European Union. If you wish to discard these items, please contact your local authorities or dealer and ask for the correct method of disposal.

(weee_eu_en_02)

PRECAUTIONS

PLEASE READ CAREFULLY BEFORE PROCEEDING

Please keep this manual in a safe and handy place for future reference.



WARNING

Always follow the basic precautions listed below to avoid the possibility of serious injury or even death from electrical shock, short-circuiting, damages, fire or other hazards. These precautions include, but are not limited to, the following:

Power supply/Power cord

- Do not place the power cord near heat sources such as heaters or radiators. Also, do not excessively bend or otherwise damage the cord, or place heavy objects on it.
- Only use the voltage specified as correct for the instrument. The required voltage is printed on the name plate of the instrument.
- Use only the supplied power cord/plug.
- Check the electric plug periodically and remove any dirt or dust which may have accumulated on it.
- Be sure to connect to an appropriate outlet with a protective grounding connection. Improper grounding can result in electrical shock.

Do not open

- This instrument contains no user-serviceable parts. Do not open the instrument or attempt to disassemble or modify the internal components in any way. If it should appear to be malfunctioning, discontinue use immediately and have it inspected by qualified Yamaha service personnel.

Water warning

- Do not expose the instrument to rain, use it near water or in damp or wet conditions, or place on it any containers (such as vases, bottles or glasses) containing liquids which might spill into any openings. If any liquid such as water seeps into the instrument, turn off the power immediately and unplug the power cord from the AC outlet. Then have the instrument inspected by qualified Yamaha service personnel.
- Never insert or remove an electric plug with wet hands.

Fire warning

- Do not put burning items, such as candles, on the unit. A burning item may fall over and cause a fire.

If you notice any abnormality

- When one of the following problems occur, immediately turn off the power switch and disconnect the electric plug from the outlet. Then have the device inspected by Yamaha service personnel.
 - The power cord or plug becomes frayed or damaged.
 - It emits unusual smells or smoke.
 - Some object has been dropped into the instrument.
 - There is a sudden loss of sound during use of the instrument.
 - If any cracks or breakages exist on the instrument.



CAUTION

Always follow the basic precautions listed below to avoid the possibility of physical injury to you or others, or damage to the instrument or other property. These precautions include, but are not limited to, the following:

Power supply/Power cord

- Do not connect the instrument to an electrical outlet using a multiple-connector. Doing so can result in lower sound quality, or possibly cause overheating in the outlet.
- When removing the electric plug from the instrument or an outlet, always hold the plug itself and not the cord. Pulling by the cord can damage it.
- Remove the electric plug from the outlet when the instrument is not to be used for extended periods of time, or during electrical storms.

Location

- Do not place the instrument in an unstable position where it might accidentally fall over.
- Before moving the instrument, remove all connected cables, to prevent damage to the cables or injury to anyone who might trip over them.
- When setting up the product, make sure that the AC outlet you are using is easily accessible. If some trouble or malfunction occurs, immediately turn off the power switch and disconnect the plug from the outlet. Even when the power switch is turned off, electricity is still flowing to the product at the minimum level. When you are not using the product for a long time, make sure to unplug the power cord from the wall AC outlet.

Connections

- Before connecting the instrument to other electronic components, turn off the power for all components. Before turning the power on or off for all components, set all volume levels to minimum.
- Be sure to set the volumes of all components at their minimum levels and gradually raise the volume controls while playing the instrument to set the desired listening level.

Handling caution

- Do not insert a finger or hand in any gaps on the instrument.
- Never insert or drop paper, metallic, or other objects into the gaps on the panel or keyboard. This could cause physical injury to you or others, damage to the instrument or other property, or operational failure.
- Do not rest your weight on, or place heavy objects on the instrument, and do not use excessive force on the buttons, switches or connectors.
- Do not use the instrument/device or headphones for a long period of time at a high or uncomfortable volume level, since this can cause permanent hearing loss. If you experience any hearing loss or ringing in the ears, consult a physician.

Yamaha cannot be held responsible for damage caused by improper use or modifications to the instrument, or data that is lost or destroyed.

Always turn the power off when the instrument is not in use.

Even when the [STANDBY/ON] switch is in standby status (display is off), electricity is still flowing to the instrument at the minimum level.

When you are not using the instrument for a long time, make sure you unplug the power cord from the wall AC outlet.

NOTICE

To avoid the possibility of malfunction/ damage to the product, damage to data, or damage to other property, follow the notices below.

■ Handling

- Do not use the instrument in the vicinity of a TV, radio, stereo equipment, mobile phone, or other electric devices. Otherwise, the instrument, TV, or radio may generate noise. When you use the instrument along with an application on your smart device such as a smartphone or tablet, we recommend that you set “Airplane Mode” to “ON” on that device in order to avoid noise caused by communication.
- Do not expose the instrument to excessive dust or vibrations, or extreme cold or heat (such as in direct sunlight, near a heater, or in a car during the day) to prevent the possibility of panel disfiguration, damage to the internal components or unstable operation.
- Do not place vinyl, plastic or rubber objects on the instrument, since this might discolor the panel or keyboard.

■ Maintenance

- When cleaning the instrument, use a soft and dry (or slightly damp) cloth. If the panel (front, side and bottom, excepting the controllers and the keyboard) is dirty, wipe the dirt away using a cloth moistened with a neutral detergent solution and tightly wrung out. Following this, wipe away the detergent solution using a cloth soaked in water and tightly wrung out. Do not use paint thinners, solvents, alcohol, or chemical-impregnated wiping cloths.
- During extreme changes in temperature or humidity, condensation may occur and water may collect on the surface of the instrument. If water is left, the wooden parts may absorb the water and be damaged. Make sure to wipe any water off immediately with a soft cloth.

■ Saving data

- Edited Live Set Sounds (including settings of the SETTINGS screens) and settings of MENU screens are lost when you turn off the power to the instrument. This also occurs when the power is turned off by the Auto Power Off function (page 23). Save the data to the instrument, or to USB flash drive/an external device such as a computer (page 25). However, the data saved to the instrument may be lost due to some failure, an operation mistake, etc. Save your important data onto USB flash drive/an external device such as a computer (page 25). Before using a USB flash drive, make sure to refer to page 26.
- To protect against data loss through USB flash drive damage, we recommend that you save your important data onto spare USB flash drive or an external device such as a computer as backup data.

Information

■ About copyrights

- Copying of the commercially available musical data including but not limited to MIDI data and/or audio data is strictly prohibited except for your personal use.
- This product incorporates and bundles contents in which Yamaha owns copyrights or with respect to which Yamaha has license to use others' copyrights. Due to copyright laws and other relevant laws, you are NOT allowed to distribute media in which these contents are saved or recorded and remain virtually the same or very similar to those in the product.
 - * The contents described above include a computer program, Accompaniment Style data, MIDI data, WAVE data, voice recording data, a score, score data, etc.
 - * You are allowed to distribute medium in which your performance or music production using these contents is recorded, and the permission of Yamaha Corporation is not required in such cases.

■ About this manual

- The illustrations and LCD screens as shown in this manual are for instructional purposes only, and may appear somewhat different from those on your instrument.
- iPhone and iPad are trademarks of Apple Inc., registered in the U.S. and other countries.
- IOS is a trademark or registered trademark of Cisco in the U.S. and other countries and is used under license.
- The company names and product names in this manual are the trademarks or registered trademarks of their respective companies.

The model number, serial number, power requirements, etc., may be found on or near the name plate, which is at the bottom of the unit. You should note this serial number in the space provided below and retain this manual as a permanent record of your purchase to aid identification in the event of theft.

Model No.

Serial No.

(bottom_en_01)

Welcome

Thank you for purchasing the Yamaha YC61.

This instrument is a Stage Keyboard designed especially for live performance.

Please read this Owner's Manual carefully before using the instrument in order to take full advantage of its various features. When you have finished reading the manual, keep it in a safe, accessible place, and refer to it when you need to better understand an operation or function.

Accessories

- Owner's Manual (this book)
- Power cord

Main Features

■ Remarkably authentic organ sounds with waterfall keyboard—striving for the ultimate realism

The YC61 is equipped with a VCM Organ tone generator and VCM Rotary Speaker simulator that have been newly developed based on Yamaha VCM (Virtual Circuitry Modeling) technology. These authentically reproduce the natural saturation and warmth of sound that are uniquely characteristic to tonewheel organs and rotary speakers—thanks to the meticulously accurate modeling of analog circuits. In addition, the YC61 is equipped with a newly developed semi-weighted waterfall keyboard—the ideal keyboard for playing organ sounds, with techniques such as glissando, etc.

■ Piano sounds of unparalleled quality, and FM sound for dynamic performance

The YC61 is equipped with high-quality acoustic piano and electric piano sounds perfected in and derived from the Yamaha CP series. It also features an FM tone generator with 128-note polyphony for smooth, dynamic performance.

■ Design embodies high-class appearance and portability

The finely crafted design and aluminum exterior of the YC61 delivers both a sleek, professional appearance in a lightweight (7.1 kg), highly portable instrument—perfect for onstage use.

■ User interface provides total intuitive control—essential for live performance

All controls required during onstage are placed in the dedicated Sections on the panel, such as Organ and Keys. This gives you direct access to the parameters you need at any time and allows you to instantly improvise sound changes, on the fly. In addition, the Organ Section features newly developed physical drawbars, which naturally deliver exceptionally high playability, and even allow you to immediately check the current settings of the drawbars (with LED indicators) when switching among different sounds (Live Set Sounds)—letting you fully concentrate on your performance.

■ Connect with other devices and expand your performance potential

Comprehensive MIDI control function and powerful Master Keyboard function make it more useful to connect and use this instrument with software synthesizers and external MIDI devices. Moreover, the instrument has a built-in Class Compliant USB Audio/MIDI interface, which makes for greater recording ease in home and professional studios, as well as greater onstage performance power.

Contents

PRECAUTIONS	5
NOTICE	7
Information	7
Welcome	8
Accessories	8
Main Features	8

Controls and Functions **10**

Front Panel	10
Settings of LCD and the lamps.....	10
Live Set.....	12
Storing a Live Set Sound	12
Swapping/Copying Live Set Sounds.....	13
Initializing the Live Set Sound	13
Organ Section	14
Keys (Key A/Key B) Section	16
EFFECT Section	17
SPEAKER/AMP Section	18
REVERB Section	19
Master EQ	19
Rear Panel.....	20

Setting Up **22**

Power Supply	22
Connecting Speakers or Headphones	22
Turning On and Off.....	22
Auto Power Off Function.....	23
Restoring the Factory Default Settings (Factory Reset)23	

Basic Structure & Display Content **23**

Top Screen Configuration.....	23
Selecting Voice Sections	23
Exiting from the Current Screen	24
Editing File Names/Live Set Sound Names	24

Saving / Loading Data **25**

Saving the settings to a USB flash drive	25
Loading the settings from a USB flash drive	25

Using with External Devices **27**

Setting the MIDI transmit and receive channels ...	28
Setting the internal tone generator to not produce sound when the built-in keyboard is played	28
Setting how the MIDI [IN]/[OUT] terminals are used (MIDI Port settings)	28
Connecting to a computer	29
Connecting an iPhone or iPad	29
USB Audio	29
MIDI.....	30

Special Operations List **31**

Insertion Effect Type List **32**

EG/Filter Control Type List **34**

MENU LIST **36**

SETTINGS LIST **42**

Appendix **51**

Display Messages.....	51
Troubleshooting	52
Specifications	54
Index.....	55

DATA LIST **56**

Live Set Sound List	56
Voice List	58
Control Change Number List.....	60
MIDI Data Format	62
MIDI Data Table	64
MIDI Implementation Chart.....	69

Controls and Functions

Front Panel

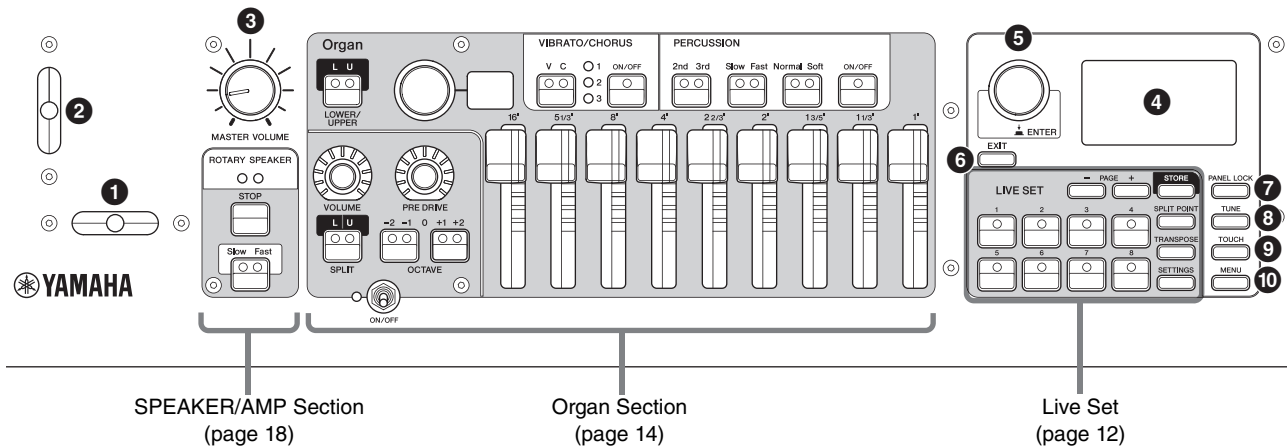

1 Bend Lever

For using as the Pitch Bend controller or as to change the rotation speed of the rotary speaker on the SPEAKER/AMP Section.

Which of the two functions is used by the Bend Lever can be set from the [SETTINGS] button → “Controllers” → “Bend Lever” → “Mode” (page 49). In the default settings, this is set to “Pitch Bend.”

NOTE

The pitch bend range can be set for each Section from the [SETTINGS] button → “Controllers” → “Bend Lever” → “Pitch Bend Range” (page 49).

2 Modulation Lever (Assignable)

For applying vibrato to the sound.

Another Control Change number can be assigned to this lever. The assignment of Control Change number can be set from the [SETTINGS] button → “Controllers” → “Modulation Lever” → “Assign” (page 49).

NOTE

- The vibrato depth and speed can be set for each Section from the [SETTINGS] button → “Controllers” → “Modulation Lever” → “P.Mod Depth”/ “P.Mod Speed” (page 49).
- The Modulation (CC#1) effect is not applied to the Organ Section when the VCM Organ type (H1 to H3) is selected. To apply the vibrato effect to the VCM Organ type, use the Organ Section VIBRATO/CHORUS (page 15).

3 [MASTER VOLUME] knob

For adjusting the overall volume of the instrument.

4 LCD

Displays the system messages, parameter settings, and a range of other information depending on the function currently being used.

■ Settings of LCD and the lamps

To make the following settings, press the [MENU] button → “Control Panel” → “Display Lights.”

Section	For setting whether the indicator lamps of each Section are always lit up (“On”) regardless of the status of the corresponding Section [ON/OFF] switch.
Ins Effect	For setting whether the lamps in the EFFECT 1 and 2 areas of the Key A/Key B Sections are always lit up (“On”) regardless of the status of each of the EFFECT 1/2 [ON/OFF] buttons.
LCD SW	For setting whether to display (“On”) or not display (“Off”) the Top screen of the LCD. The various setting screens such as the MENU screens and the SETTINGS screens are always shown regardless of this setting.
LCD Contrast	For adjusting the contrast of the LCD.

5 Encoder dial/[ENTER] button

For displaying the Live Set View (page 12) on the LCD and to edit the currently selected parameter. In the MENU and SETTINGS screens, use this dial to move the cursor (highlighted) up or down.

Also, pressing the Encoder dial is equivalent to pressing the [ENTER] button. Use this button to determine the selected parameter or to execute each operation.

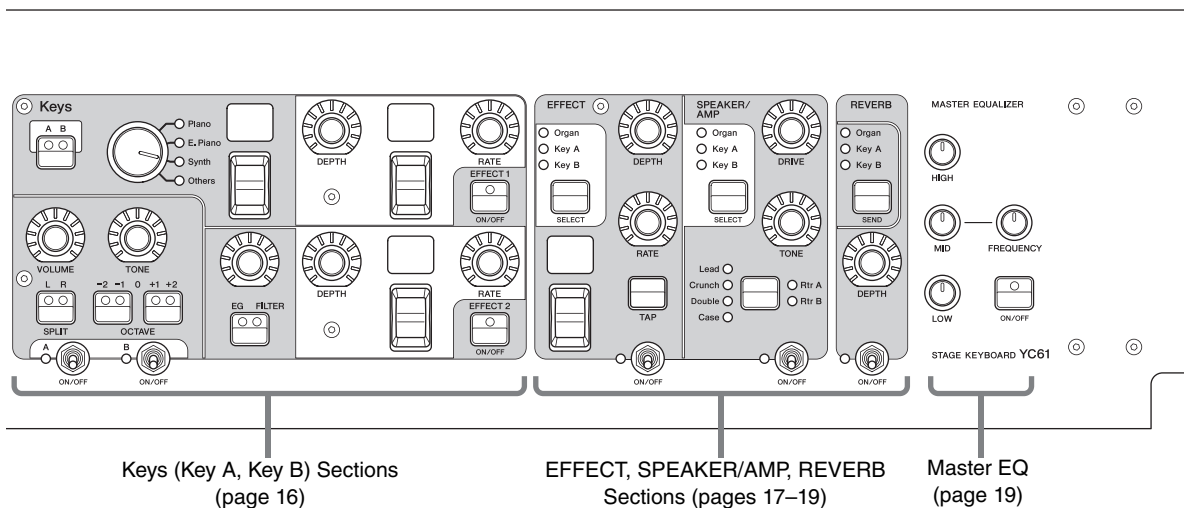

6 [EXIT] button

The MENU screens and the SETTINGS screens have a hierarchical structure. Press this button to exit from the current screen and return to the previous level. Also, holding down this button and pressing other specific buttons/knobs gives you access to a variety of convenient shortcuts and quick operations (Special Operations; page 31).

7 [PANEL LOCK] button

When this is set to “On,” control panel operations are disabled, ensuring the settings cannot be inadvertently changed. While the panel lock is engaged,  will appear on the top left corner of the LCD display.

NOTE

Panel lock settings can be made individually for the following areas from the [MENU] button → “Control Panel” → “Panel Lock Settings” (page 39).

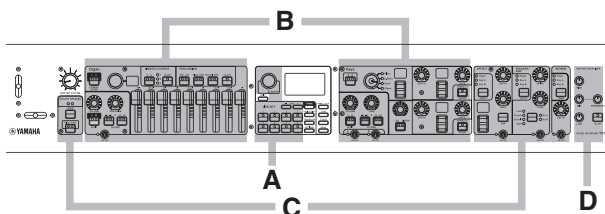

- A. Live Set
- B. Organ/Keys
- C. Effect/Sp Amp/Reverb
- D. Master EQ

8 [TUNE] button

For setting the tuning for the entire instrument (414.72–466.78 Hz, the default value is 440.00 Hz). Press the [TUNE] button, and then use the Encoder dial to change the value.

9 [TOUCH] button

For selecting curves that determine how the actual velocities will be generated according your playing strength. The following five types of settings are available. The setting can also be changed from the [MENU] button → “General” → “Keyboard/Pedal” → “Touch Curve” (page 38).

Settings	Characteristics
Normal	This curve produces velocities in direct proportion to the strength of your keyboard playing. This is the most common type of curve.
Soft	This curve makes it easier to produce high velocities across the entire keyboard.
Hard	This curve makes it more difficult to produce high velocities across the entire keyboard.
Wide	This curve accentuates your playing strength by producing lower velocities in response to softer playing and louder velocities in response to harder playing. You can use this setting to expand the dynamic range of your performances.
Fixed	This curve produces the same amount of sound change, regardless of how hard or soft you play the keyboard. The fixed velocity can be set from the [MENU] button → “General” → “Keyboard/Pedal” → “Fixed Velocity.”

NOTE

Conventionally, organs do not respond to playing strength (key velocity). Because of this, the Organ Section only produces a fixed-velocity sound, regardless of playing strength, and the settings of the [TOUCH] button do not affect the Organ Section.

10 [MENU] button

For calling up the screens for making overall system settings (page 36).

Live Set

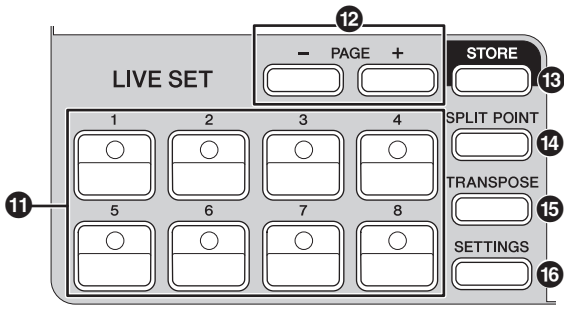

11 Live Set Sound [1]–[8] buttons

For calling up the stored Live Set Sounds.

Live Set Sound

The name “Live Set Sound” refers to sound settings that include the Voices of the Organ Section (page 14) and Keys Sections (Key A/Key B; page 16), the Effects of the EFFECT Section (page 17) and SPEAKER/AMP Section (page 18) and REVERB Section (page 19). You can freely combine Voices and Insertion Effects to create and store a custom Live Set Sound, and then easily call up that sound. This instrument features an SSS (Seamless Sound Switching) function to ensure that the sound does not cut off even when switching the Live Set Sound, resulting in a more natural performance.

NOTE

If you wish to mute the sound continued due to SSS, press the currently selected Live Set Sound button again.

12 PAGE [-]/[+] buttons

For switching the Live Set Page. The Live Set Sound changes accordingly.

Live Set

A Live Set combines Live Set Sounds [1]–[8] into a single Live Set Page. A total of 20 pages can be stored. With the default settings (factory settings), the preset Live Set Sounds have been installed in the Live Set Pages 1–10.

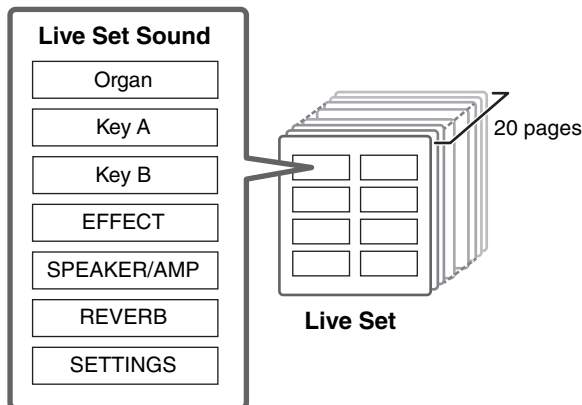

Live Set View

Turn the Encoder dial when at the Top screen to open the Live Set View. On the Live Set View, the names of the Live Set Sounds [1]–[8] for one Live Set Page are displayed in a screen. The indication will appear on the left of the currently selected Live Set Sound. To change the Live Set Sound in Live Set View, turn the Encoder dial to select a Live Set Sound, and then press the [ENTER] button. Once the change is made, it will return automatically to the Top screen. To keep the Live Set View displayed during performances, set “Live Set View Mode” to “Keep” (page 39).



Live Set View Mode

13 [STORE] button

For storing the edited Live Set Sound.

The following content is stored. Stored settings will be retained when this instrument is turned off.

- Settings of the Organ Section
- Settings of the Key A and Key B Sections
- Settings of the EFFECT Section
- Settings of the SPEAKER/AMP Section
- Settings of the REVERB Section
- Settings in SETTINGS (including SPLIT POINT and TRANSPOSE)

NOTE

Settings of the Master EQ cannot be stored in Live Set Sound.

■ Storing a Live Set Sound

1. Press the [STORE] button.

A screen for selecting the Live Set Sound to be stored to appears.



2. Press the [ENTER] button to store the data.

“Completed.” appears on the screen, and then it returns to the Top screen.

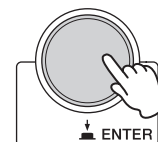

NOTE

If you wish to store the currently edited settings to another Live Set Sound, use the Encoder dial to select which Live Set Sound to store the data to. You can confirm the sound of that has already been stored in the destination by playing the keyboard, before step 2.

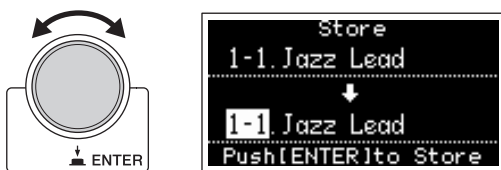
**NOTICE**

- The settings will be overwritten if you change the settings of an existing Live Set Sound (including one of the preset Live Set Sounds) and then store those changes. Proceed with caution, as the original settings will be lost.
- The settings currently being edited will be lost if you select a different Live Set Sound or turn off the power before storing the settings.

NOTE

- If you selected a different Live Set Sound causing your edits to be lost, you can use the “Edit Recall” function to recall the last edited status (page 41).
- You can download the preset Live Set Sounds from Soundmondo. Soundmondo is a service for managing and sharing the Sound settings on an iOS application or by using the Google Chrome browser on a Mac or PC. For details, refer to the website below.
<http://www.yamaha.com/2/soundmondo>

■ Swapping/Copying Live Set Sounds**1. Call up the Live Set Sound you want to swap from or copy.****2. Open the operating screen.**

[MENU] button → “Job” → “Live Set Manager” → “Swap”/“Copy.”

**3. Select the Live Set Sound you want to swap to or copy to.**

Use the Encoder dial to select the intended Live Set Sound. Press the [ENTER] button. The messages “Executing.” → “Completed.” appear on the screen, and then operation returns automatically to the Top screen.

■ Initializing the Live Set Sound**1. Call up the Live Set Sound you want to initialize.**

[MENU] button → “Job” → “Live Set Manager” → “Initialize.”

3. Execute initialization.

Use the Encoder dial to select “Live Set Sound Init” and then press the [ENTER] button. The messages “Initializing.” → “Completed.” appears on the screen, and then it returns automatically to the Top screen.

NOTE

If you want to reset the sound settings currently being edited to the default state, press the [EXIT] and the [SETTINGS] buttons simultaneously. This operation does not overwrite the stored Live Set Sound.

14 [SPLIT POINT] button

For changing the Split Point. Turn the Encoder dial or press the key you wish to assign as the Split Point. The setting will be stored in the current Live Set Sound.

Split

The Split function allows you play different Voices with the right and left hands. The point on the keyboard that separates the right hand section and the left hand section of the keyboard is called the “Split Point.”

NOTE

- You can also set by pressing the desired key while holding the [SPLIT POINT] button.
- The note set as the Split Point becomes the lowest note of the right hand section.
- The Split Point can also be changed from the [SETTINGS] button → “Function” → “Split Point” (page 44).

15 [TRANPOSE] button

For adjusting the pitch in semitone steps. The settings can be stored to the Live Set Sound. The settings can also be changed from the [SETTINGS] button → “Sound” → “Function” → “Transpose” (page 44).

16 [SETTINGS] button

For calling up the screens for making detailed settings for the currently selected Live Set Sound (page 42). You can make various settings, including the Organ customization and Mono/Poly settings for Key A and Key B. Settings made here are stored in the Live Set Sound.

Organ Section

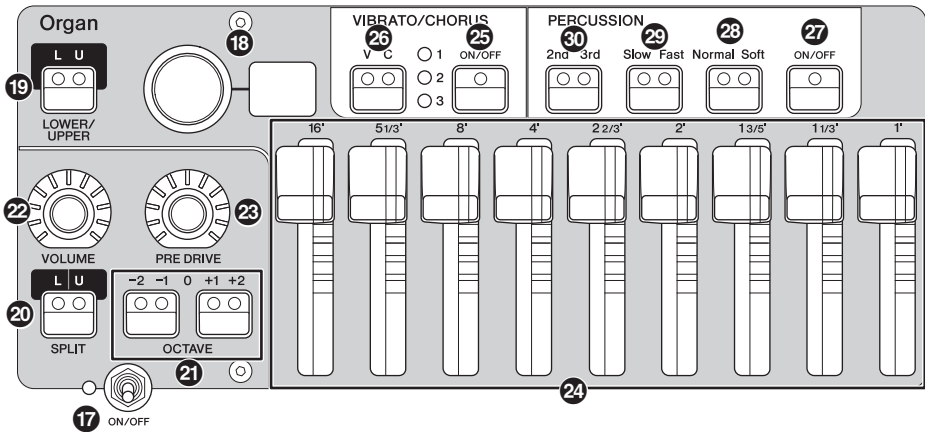

The YC61 Organ Section allows you to select an organ type from the VCM Organ tone generator that faithfully reproduces a tonewheel-type vintage organ or an FM tone generator that reproduces a transistor-type organ, and uses physical drawbars allowing you to perform while changing the organ sound in real time. You can also adjust the detailed parameters to create an organ sound that includes differences between individual instruments etc.

VCM Organ tone generator



The VCM Organ tone generator was developed to faithfully reproduce the sound of a tonewheel-type vintage organ. VCM stands for “Virtual Circuitry Modeling™,” and is technology that uses DSP to emulate the functions of an analog electric circuit. This technology enables the instrument to reproduce sound with an analog-like depth, which cannot be reproduced by a simple digital sound.

By applying this technology, the VCM Organ tone generator fully reproduces the following characteristics of a vintage organ.

- Natural, organic harmonies when playing chords—thanks to a matrix circuit that connects the keyboard, tone wheels, and drawbars
- Percussion sound with remarkable presence—based on vacuum tube circuit analysis
- Key clicks and leakage sounds—based on electrical circuit analysis
- Natural sound distortion—simulating vintage vacuum tube pre-amplifiers
- Vibrato/Chorus effect—from scanner-based vibrato circuitry
- Changes in frequency characteristics and drive amount that responds dynamically to operation of the expression pedal

Adjustment of these detailed parameters makes it possible to accurately recreate the distinctive characteristics of the original instruments—including all of their specially attractive imperfections, faults and even deterioration.

17 Section [ON/OFF] switch

To enable (turn on) or disable (turn off) this Section. When this Section is enabled (on), the lamp lights up and pressing a key generates sound.

18 Organ type selector/display

Turn the Encoder dial to select the Organ type to be used. The selected type (H1–H3, F1–F3) is shown on the display.

H1–H3 indicate the VCM Organ types, while F1–F3 indicate the types using the FM tone generator.

H1	This type faithfully reproduces a standard vintage organ. It is fit for organ solos and music in which the organ is the main instrument.
H2	This type is characterized by its deep sound with emphasis in the mid- to low-range tones. It is ideal for when you want to have an edge or presence that cuts through the rest of the band or ensemble.
H3	This type has a unique percussion sound. This type works well with the drive effects, and is suitable for playing fast passages.
F1	This organ generates simple sine waves.
F2	This type recreates a famous British transistor combo organ.
F3	This type recreates a famous Italian transistor combo organ.

The type setting is common to both LOWER and UPPER parts.

NOTE

The organ sound characteristics (such as leakage level of the tonewheel and volume of the key click sound) can be set from the [SETTINGS] button → “Sound” → “Organ Settings” (page 42). These settings are stored in the Live Set Sound.

19 LOWER/UPPER [L U] button

The Organ Section is divided into two parts: LOWER and UPPER. Use this button to select which of those two parts you want to display/change the settings of.

20 SPLIT [L U] button

For selecting the setting whether each part of the Organ sounds or not when you play each keyboard section relative to the Split Point. Pressing the button alternates sequentially between the four settings.

Off	The part selected by the LOWER/UPPER [L U] button sounds, regardless of which key you play.
L+U	The LOWER part sounds when you play the left section of the keyboard, and the UPPER part generates sounds when you play the right section of the keyboard.
U	The part selected by the LOWER/UPPER [L U] button sounds only when you play the right section of the keyboard. The LOWER/UPPER [L U] is automatically changed to "U."
L	The part selected by the LOWER/UPPER [L U] button sounds only when you play the left section of the keyboard. The LOWER/UPPER [L U] is automatically changed to "L."

NOTE

For details about the Split Point, refer to page 13.

21 OCTAVE [-2 -1]/[+1 +2] buttons

To change the range of the keyboard in units of one octave.

Press the [-2 -1] button and [+1 +2] button simultaneously to restore the value to "0." This can be set separately for the LOWER and UPPER parts.

22 [VOLUME] knob

For adjusting the volume of this Section. For the Organ Section, this parameter is common to both the LOWER and UPPER parts.

23 [PRE DRIVE] knob

For changing the gain of the Organ pre-amplifier. It models the changes in distortion caused by a pre-amplifier adjustment screw in the organ body. This parameter is common to both the LOWER and UPPER parts.

24 Drawbars

For adjusting the composition of the Organ's harmonics and determine the character of the sound. When you move a drawbar, the LED lights up to match the current setting and the sound changes—as if you were pulling out a drawbar on a vintage organ.

NOTE

- In situations like when you call up settings from the Live Set, the actual position of the drawbars and the LED displays (currently set values) will not match. If you move a drawbar, that position will be reflected in the settings. Or, if you press the LOWER/UPPER [L U] button while holding the [EXIT]

button, the values for the actual positions of all the drawbars are immediately reflected in the settings without having to move the drawbars.

- You can change the behavior for matching the actual positions and the LED displays when drawbars are moved, from the [MENU] button → "Control Panel" → "Advanced Settings" → "Drawbar Mode" (page 39).
- For organ types F1–F3, the 1' drawbar is disabled.
- You can set the color of the drawbar LEDs separately for the LOWER and UPPER parts from the [SETTINGS] button → "Drawbar Color" → "Upper"/ "Lower" (page 50). These settings are stored in the Live Set Sound.

25 VIBRATO/CHORUS [ON/OFF] button

Enables the vibrato/chorus effects (lamp lights when on). These effects are only available for the VCM Organ types (H1–H3), and can be set separately for the LOWER and UPPER parts.

26 VIBRATO/CHORUS type selection button

For selecting the VIBRATO/CHORUS type. Pressing the button alternates sequentially between V (vibrato) 1–3 and C (chorus) 1–3. This setting is common to both the LOWER and UPPER parts.

27 PERCUSSION [ON/OFF] button

Determines whether a percussion sound is generated or not when a key is pressed. Percussion can be used only with the UPPER part using the VCM Organ type (H1–H3).

NOTE

You can set whether to link the percussion sound and the [1'] drawbar and only have one of them generate sound from the [SETTINGS] button → "Sound" → "Organ Settings" → "Perc. Link to 1feet" (page 42). With default settings, this is set to "On." These settings are stored in the Live Set Sound.

28 PERCUSSION [Normal Soft] button

For switching the level of the percussion sound.

29 PERCUSSION [Slow Fast] button

For switching the decay speed of the percussion sound.

30 PERCUSSION [2nd 3rd] button

For switching the pitch (harmonic) of the percussion sound.

- When this is set to [2nd], pressing a key generates a percussion sound at the same pitch as the [4'] drawbar (2nd harmonic).
- When this is set to [3rd], pressing a key generates a percussion sound at the same pitch as the [2 2/3'] drawbar (3rd harmonic).

Keys (Key A/Key B) Section

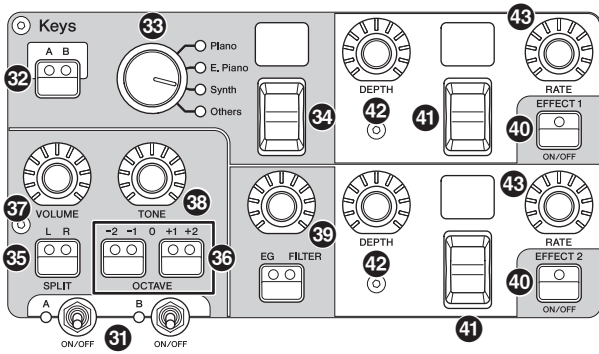

The YC61 Keys Sections (Key A/Key B) allow you to select a Voice for each Key from the four categories of Piano, Electric Piano, Synth, and Other. Furthermore, EG, FILTER, and two Insertion Effects (EFFECT 1, EFFECT 2) can be set individually for each of the Key A and Key B Sections. You can also make sound layers or splits, using both Key A and Key B Sections simultaneously.

31 Section [ON/OFF] switch

For enabling (turning on) or disabling (turning off) the Key A and Key B Sections, respectively.

32 Keys [A B] button

For selecting which of the Key A and Key B Sections you want to display/change the settings of.

NOTE

- You can switch the settings of the Key A and Key B Sections by pressing the [EXIT] + Keys [A B] buttons (page 31).
- If both the Key A and Key B Sections are off, nothing will be displayed if this button is pressed.
You can also set so that the settings are displayed even when these Sections are off. Set the value under the [MENU] button → “Control Panel” → “Display Lights” → “Section” to “On” (page 39).

33 Voice category selector

For selecting the Voice category to be used in the currently selected Section.

34 Voice selection switch/display

For selecting one of the Voices of the category selected with the Voice category selector. The currently selected Voice number is displayed. Operating this switch while holding the [EXIT] button moves to the top of next/previous Voice subcategory (page 31).

For a list of Voices available for the Key A and Key B Sections, refer to page 58.

35 SPLIT [L R] button

Determines where the currently selected Section can be played on the keyboard, with the Split Point as the basis. Pressing the button alternates sequentially between the three settings.

L+R	The Section sounds no matter where on the keyboard you play.
L	The Section sounds only when you play the left section of the keyboard.
R	The Section sounds only when you play the right section of the keyboard.

36 OCTAVE [-2 -1]/[+1 +2] buttons

Determines the octave range of the keyboard for the currently selected Section in units of one octave. Press the [-2 -1] button and [+1 +2] button simultaneously to restore the value to “0.”

37 [VOLUME] knob

For adjusting the volume of the currently selected Section.

38 [TONE] knob

For adjusting the tone of the currently selected Section. When the knob is in the center, the tone is flat. Turn the knob to the right to boost the higher and lower ranges, or turn it to the left to cut them.

39 [EG FILTER] button/knob

The knob here lets you adjust (with a convenient, single control) the EG or FILTER of the currently selected Section, while pressing the button selects the specific parameter for knob control (EG or FILTER).

NOTE

The EG and FILTER control types for each of the Key A and Key B Sections can be selected from different types of changes. Change the types by operating the [EXIT] button + [EG FILTER] knob, or from the [SETTINGS] button → “Sound” → “Key A Settings”/ “Key B Settings” → “EG Control”/ “Filter Control.” For details on the EG/Filter control types, see page 34.

40 EFFECT 1/2 [ON/OFF] button

For turning the Insertion Effects on or off. To use the effects, set this to ON.

NOTE

To check the effect settings while the Insertion Effects are set to off, set the value under the [MENU] button → “Control Panel” → “Display Lights” → “Ins Effect” to “On” (page 39).

41 Effect type selection switch/display

Use this switch to select the type of Insertion Effects. The type name currently selected is displayed using two characters.

The Effect types that can be selected in EFFECT 1/2 and the EFFECT Section are different. For a list of the available Effect types, refer to page 32.

Operating this switch while holding the [EXIT] button, moves to the top of next/previous Effect category (page 31).

42 [DEPTH] knob

For adjusting the depth or other parameters of the Insertion Effects.

43 [RATE] knob

For adjusting the speed or other parameters of the Insertion Effects. The parameter to be adjusted differs for each effect type. For details, see page 32.

EFFECT Section

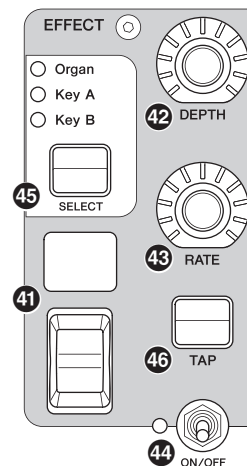

The EFFECT Section allows you to apply an Insertion Effect to either the Organ, Key A, or Key B Section. There are also two types exclusive to this Section: Tempo Delay and Looper Delay. For a list of the available effect types, refer to page 32.

44 Section [ON/OFF] switch

For enabling (turning on) or disabling (turning off) the EFFECT Section. The lamp is lit up when effects are applied.

45 [SELECT] button

For selecting the Section to which the Insertion Effects will be applied.

Effect

The YC61 features Insertion Effects that can be set individually for each of the Key A and Key B Sections, Insertion Effects that can be set for either Voice Section, and a reverb effect and Master EQ that can be set for all Voice Sections simultaneously. The illustration below shows the audio signal path.

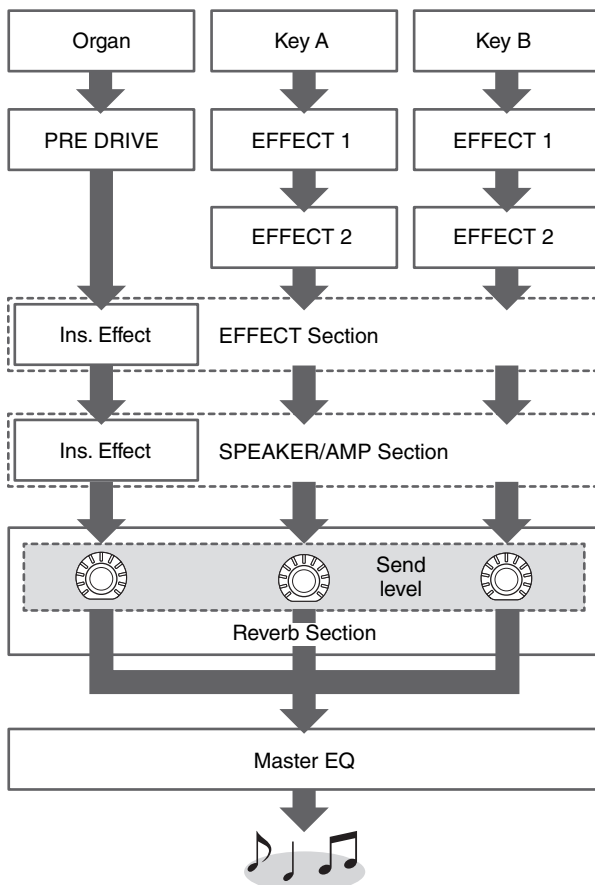

About Looper Delay

When the Looper Delay type (page 33) is selected, the EFFECT Section behaves differently from normal:

- The Looper Delay effect is applied after the SPEAKER/AMP Section. In addition, the effect of the REVERB Section is not applied to the delay sound.
- The status of the [SELECT] button lamps have a different meaning than normal. Pressing the [SELECT] button alternates between the two states (below).

All lit: The delay effect is applied to all the Organ, Key A, and Key B Sections, and the sound you play is added to the Looper.

All off: The delay effect is not applied to any of the Sections, and the sound you play will not have any Looper effect. Using this lets you effectively create a rhythmic delay “loop” as you play, and then stop adding to it so you can play phrases over it while the loop continues.

46 [TAP] button

Use this button to control the speed (tempo) when the “Tempo Delay” type is selected. Tap this button three times or more to change the tempo.

You can also change the “Tempo Delay Time” (page 45) by turning the [RATE] knob while holding the [EXIT] button.

SPEAKER/AMP Section

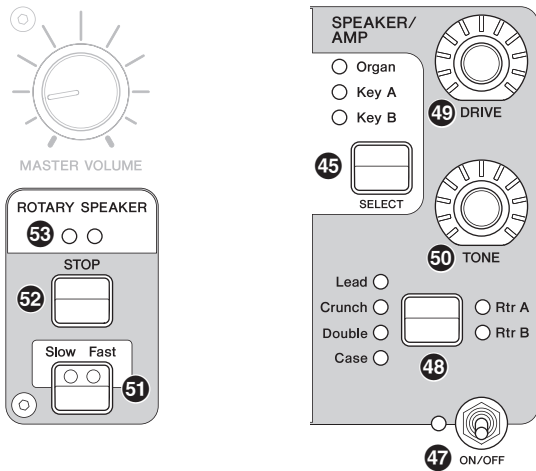

The SPEAKER/AMP Section allows you to apply speaker or amp-related Insertion Effect to either the Organ, Key A, or Key B Section. The rotary speaker type faithfully reproduces switching between slow and fast, and the behavior when stopping.

47 Section [ON/OFF] switch

For enabling (turning on) or disabling (turning off) the SPEAKER/AMP Section. The lamp is lit up when effects are applied.

48 Effect type switching button

Alternates between the following effects. The lamp for the selected effect lights.

Effect	Description
Rtr A	Standard rotary speaker for organ.
Rtr B	Rotary speaker connected to a transistor preamplifier with strong distortion.
Lead	Guitar amp that features a bass of high sound pressure, and a sharp treble.
Crunch	Guitar amp that features a crunch sound.
Double	Guitar amp that features a bright sound.
Case	Speaker amp for a vintage electric piano.

NOTE

- If you have selected either the Rtr A or Rtr B type, you can use the ROTARY SPEAKER [STOP]/[Slow Fast] button to control the operation of the rotary speaker. You can also fine-

tune the status of the rotary speaker from [SETTINGS] button → “Sound” → “Rotary Speaker” (page 44).

- Rtr A and Rtr B use monaural input and stereo/monaural output. Select whether to use stereo output or monaural output from [SETTINGS] button → “Sound” → “Rotary Speaker” → “Stereo/Mono.”
- Lead, Crunch, Double, and Case use stereo input and stereo output.

49 [DRIVE] knob

For adjusting the amount of distortion in the speaker/amp sound. Turn this knob to the right to increase the distortion.

50 [TONE] knob

For adjusting the tone of the speaker/amp sound. When the knob is in the center, the tone is flat. Turn to the right to boost treble and cut bass. Turn to the left to boost bass and cut treble.

51 [Slow Fast] button

For switching the rotation speed of the rotary speaker. Pressing the [Slow Fast] button while a type other than Rtr A or Rtr B is selected automatically selects the Rtr A type. In addition, pressing this button will automatically turn the SPEAKER/AMP Section on even if the Section itself is off.

Controllers that can be used for switching the Slow/Fast

The rotary speaker rotation speed switching function can also be assigned to the following controllers.

- Bend Lever
- Modulation Lever
- FOOT CONTROLLER [1]
- FOOT CONTROLLER [2]
- FOOT SWITCH [SUSTAIN]
- FOOT SWITCH [ASSIGNABLE]

The function of the FOOT SWITCH [ASSIGNABLE] can be set via the [MENU] button → “General” → “Keyboard/Pedal” → “Foot Switch Assign” (page 38).

The function of the other controllers can be set via the [SETTINGS] button → “Controllers” (page 49).

52 [STOP] button

For stopping the rotation of the rotary speaker. Pressing and holding the button for a few seconds immediately stops the rotary speaker, and resets the position.

53 [ROTARY SPEAKER] lamp

This lamp gives you visual indication of the rotation speed of the rotary speaker, by flashing in time with the speed.

REVERB Section

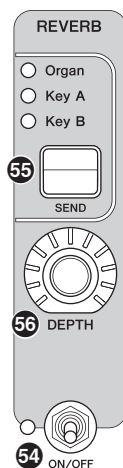

The REVERB Section applies a reverb effect to all Voice Sections, creating a rich, special ambience as if you are playing in a concert hall or other performance space.

54 Section [ON/OFF] switch

For enabling (turning on) or disabling (turning off) the REVERB Section. The lamp is lit up when effects are applied.

55 [SEND] button

Determines the Section for adjusting the Send level of the reverb effect. When all three lamps are lit up, you can equally adjust the send level for each Section.

56 [DEPTH] knob

For adjusting the send level (effect depth) of the reverb effect for the Section selected with the [SEND] button.

Master EQ

MASTER EQUALIZER

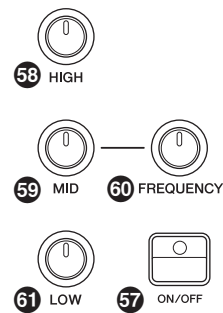

Master EQ adjusts the tone of the overall sound.

57 MASTER EQUALIZER [ON/OFF] button

To enable (turn on) or disable (turn off) the Master EQ. The lamp is lit up when Master EQ is applied.

NOTE

The Master EQ settings cannot be stored in Live Set Sound.

58 [HIGH] knob

For setting the gain (-12 to +12) of the high range (5 kHz).

59 [MID] knob

For setting the gain (-12 to +12) of the middle range (100 to 10 kHz).

60 [FREQUENCY] knob

For setting the center frequency of the middle range.

61 [LOW] knob

For setting the gain (-12 to +12) of the low range (80 Hz).

Rear Panel

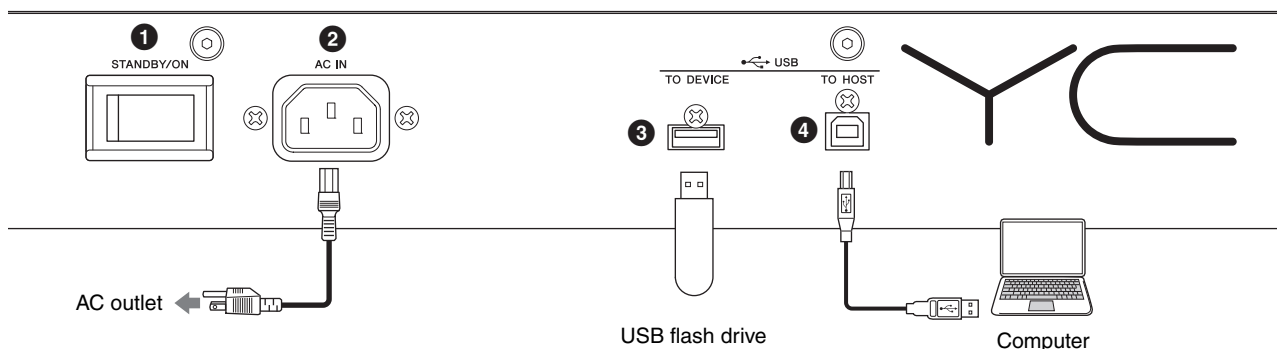

1 [STANDBY/ON] switch

For switching the instrument to standby or turning it on.

2 [AC IN] jack

For connecting the supplied AC power cord.

3 USB [TO DEVICE] terminal

For connecting a USB flash drive to this instrument, allowing you to use the device to save data you have created and load data you want to restore.

NOTE

Only a USB flash drive can be recognized by this instrument. No other USB devices (such as a hard disk drive, CD-ROM drive or USB hub) can be used.

4 USB [TO HOST] terminal

For connecting this instrument to a computer, iPhone or iPad via a USB cable, allowing you to transfer MIDI data and audio data between the devices. Unlike the communication via the MIDI [IN]/[OUT] terminals, this terminal can handle two MIDI ports via a single cable. For more information on these two MIDI ports, see page 28.

NOTE

- Audio data sending capability for the instrument is a maximum two channels (one stereo channel) at a sampling rate of 44.1 kHz, 24 bit.
- For details on connecting an iPhone or iPad, refer to page 29.

5 MIDI [IN]/[OUT] terminals

With a standard MIDI cable (commercially available), you can connect an external MIDI instrument, and control it from this instrument. Likewise, you can use an external MIDI device (such as a keyboard or sequencer) to control the sounds on this instrument.

6 FOOT SWITCH [SUSTAIN] jack

For connecting an FC3A Foot Switch (sold separately) for use as a dedicated Sustain pedal.

You can also switch assignments to use the same function as the ROTARY SPEAKER [Slow Fast] button (page 18) instead of the Sustain function. Function assignment can be set from the [SETTINGS] button → “Controllers” → “Sustain Pedal.”

7 FOOT SWITCH [ASSIGNABLE] jack

For connecting a separately sold foot switch (FC4A or FC5) in order to perform a range of freely assignable functions such as a soft pedal, sostenuto pedal, and switching Live Set Sounds. In the default settings, “Live Set+” is assigned.

You can assign functions from the [MENU] button → “General” → “Keyboard/Pedal” → “Foot Switch Assign” (page 38). Refer to page 60 for a list of the parameters that can be assigned to this instrument.

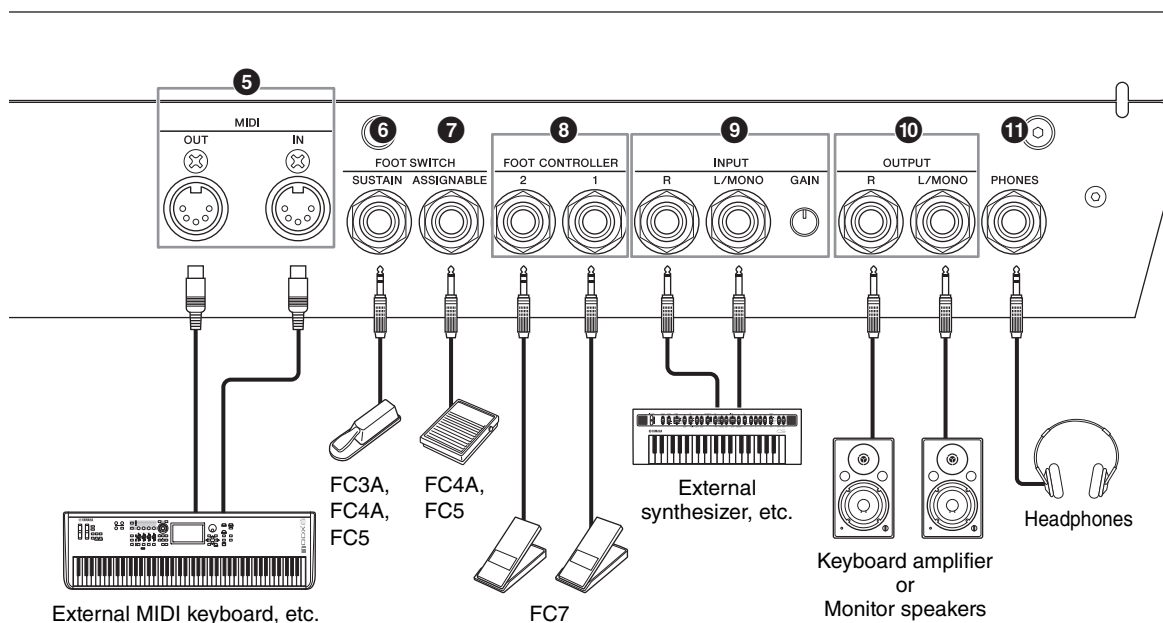

8 FOOT CONTROLLER [1]/[2] jacks

For connecting a separately sold foot controller (FC7), which conveniently lets you continuously control one of various different assignable functions with your foot—such as volume and the tone of Voice Sections. In the default settings, “Expression” is assigned to FOOT CONTROLLER [1], and “Pedal Wah” is assigned to FOOT CONTROLLER [2].

You can assign functions to the foot controller from the [SETTINGS] button → “Controllers” → “Foot Controller 1” / “Foot Controller 2” → “Assign.” Refer to page 60 for a list of the parameters that can be assigned.

9 INPUT [L/MONO]/[R] jacks/[GAIN] knob

These jacks allow you to connect an external audio devices and mix the output of that device with that of this instrument. Use the [GAIN] knob to adjust the volume balance with this instrument.

10 OUTPUT [L/MONO]/[R] jacks

Use these two 1/4" standard mono phone (unbalanced) jacks together to output stereo audio signals. When using mono output, connect only to the [L/MONO] jack.

11 [PHONES] jack

Use this 1/4" standard stereo phone jack to connect a pair of headphones.

CAUTION

- To prevent hearing loss, avoid using headphones at high volumes for extended periods of time.
- Whenever connecting other audio equipment, ensure that all devices are turned off.

NOTE

The sound output via the headphones is identical to that output via the OUTPUT [L/MONO]/[R] jacks. Furthermore, plugging in or disconnecting a set of headphones has no effect on whether the sound is output via these jacks.

Setting Up

Power Supply

Connect the respective ends of the supplied AC power cord in the following order. Make sure the [STANDBY/ON] switch on the instrument is set to the STANDBY position.

1. Connect the supplied power cord to the [AC IN] jack on the instrument's rear panel.
2. Connect the other end of the power cord to an AC outlet.

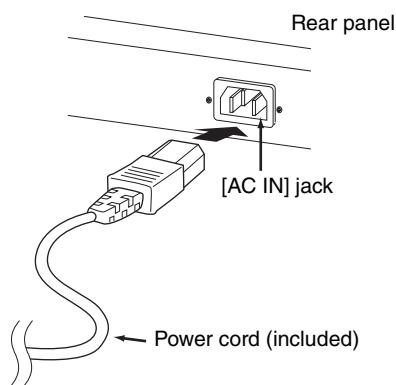

NOTE

Follow this procedure in reverse order when disconnecting the power cord.



WARNING

- Use only the AC power cord supplied with your instrument. The use of an inappropriate replacement can lead to overheating or electric shock.
- The power cord supplied with your instrument must not be used with other electrical equipment. Failure to observe this precaution can result in damage to the equipment or fire.
- Make sure your instrument the voltage requirement for the country or region in which it is being used.



CAUTION

The instrument remains charged and draws a small amount of power even when the [STANDBY/ON] switch is set to the STANDBY position. If you intend not to use it for an extended period of time, therefore, make sure to unplug the power cord from the wall outlet.

Connecting Speakers or Headphones

Since the instrument has no built-in speakers, you will need to monitor the sound of the instrument by using external equipment. Connect a set of headphones, monitor speakers, or other playback equipment as illustrated below. When making connections, be sure that your cables have the appropriate ratings.

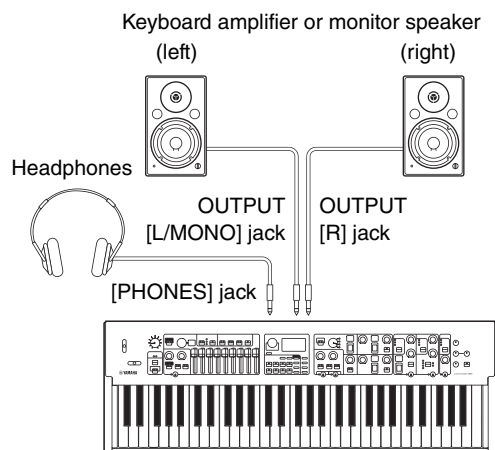

Turning On and Off

Make sure the volume settings of the instrument and external devices such as powered speakers are turned to the minimum before turning the power on. When connecting the instrument to monitor speakers, turn on the power switch of each device in the following order.

■ Turning on

Turn the [MASTER VOLUME] knob of this instrument to its minimum (left-most setting) → set the [STANDBY/ON] switch to ON → turn the amplifier or speaker power on.

■ Turning off

Turn the [MASTER VOLUME] knob of this instrument to its minimum (left-most setting) → turn the amplifier or speaker power off → set the [STANDBY/ON] switch to STANDBY.

Auto Power Off Function

The Auto Power Off function automatically turns off this instrument after 30 minutes of inactivity. By default, this is set to “Disable.”

■ Setting the Auto Power Off function

[MENU] button → “General” → “Auto Power Off” → “Enable” (page 38).

NOTICE

- Since any unsaved data will be lost when the Auto Power Off function turns off this instrument. Make sure to store your work before this occurs.
- Depending on the instrument status, the power may not turn off automatically, even after the specified period of time elapses. Always turn off the power manually when the instrument is not in use.

Restoring the Factory Default Settings (Factory Reset)

The Factory Reset function allows you to restore this instrument to its initial condition. To execute the factory Reset function, press the [MENU] button → “Job” → “Factory Reset.”

NOTICE

When the Factory Reset function is executed, all the Live Set Sounds and the settings of MENU screens and SETTINGS screens will be overwritten with their defaults. It is wise, therefore, to regularly create backup copies of important data on a USB flash drive or the like.

NOTE

Refer to page 56 for information on detailed settings of preset Live Set Sounds.

Basic Structure & Display Content

Top Screen Configuration

This section explains the Top (Live Set Sound) screen which appears when this instrument is turned on with its default settings (factory settings).

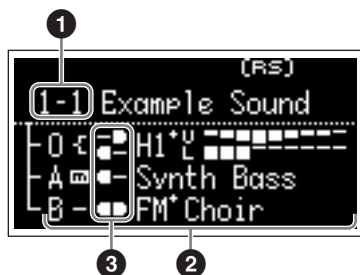

① Live Set Sound number

Displays the currently selected Live Set Sound number. The “1-1” is selected automatically when this instrument is turned on. You can also change which number is automatically selected when turned on, by changing the “Power On Sound” setting (page 40).

② Voice Sections

Indicates the status of each Section.

The sound of this instrument is divided into three Voice Sections: Organ, Key A, and Key B. The Organ (O) area shows the organ type and the approximate drawbar settings, while the Key A (A) and Key B (B) areas show the Voice names.

Voices having “FM” in the name are those using FM tone generation.

The Sections set to on will sound simultaneously in a layer. The Sections set to off are not displayed on the Top Screen and will not sound.

③ Split

Indicates the current split status of each Voice Section/part.

 indicates that the Section/part sounds when the keyboard is played in a range below the Split Point.

 indicates that the Section/part sounds when the keyboard is played in a range above the Split Point.

In addition, following special icons may appear on the Top screen depending on the Live Set Sound settings.

 “Organ Settings” (page 42) are customized.

 “FM Unison” → “Mode” (page 43) is set.

 “Mono/Poly” (page 43) is set to “Mono.”

 “Rotary Speaker” settings (page 44) are customized.

Selecting Voice Sections

To enable (ON) or disable (OFF) each Voice Section, use the corresponding Section [ON/OFF] switch. When the indicator lamp of the Section [ON/OFF] switch is lit, the corresponding Voice Section will sound when you play the keyboard. When multiple Sections are set to on, those Sections will sound simultaneously in a layer.

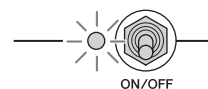

Exiting from the Current Screen

The MENU screens and the SETTINGS screens are arranged in a hierarchical structure. To move one step back to the previous hierarchy, press the [EXIT] button. Pressing the [EXIT] button several times will return you to the Top (Live Set Sound) screen.

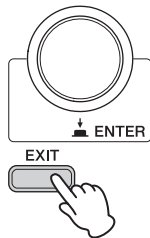

Editing File Names/Live Set Sound Names

■ Editing File Names

[MENU] button → “File” → “File Utility” → “Rename” → Select the desired file for which you wish to edit the name → Edit the name → [ENTER] button to save the file.

■ Editing Live Set Sound Names

Select the desired Live Set Sound for which you wish to edit the name → [SETTINGS] button → “Name” → Edit the name → [ENTER] button → Select “Store”/ “Do not store now.”

NOTE

If “Do not store now” is selected, the Live Set Sound will not be stored, but the edited name will remain.

■ Operations During Name Edit

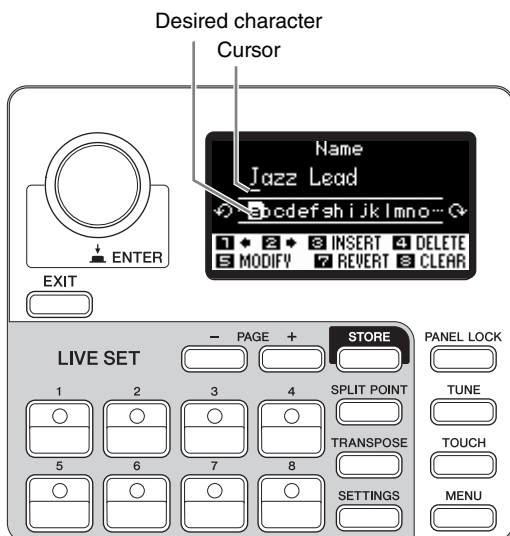

Use the Live Set Sound [1]/[2] buttons to move the cursor to the position of the character you wish to edit. Use the Encoder dial to select characters, and then use the following buttons to edit the name.

Button/Indication	Functions
Live Set Sound [1] [1] +	Moves the cursor to left.
Live Set Sound [2] [2] +	Moves the cursor to right.
Live Set Sound [3] [3] INSERT	Inserts a desired character at the cursor position.
Live Set Sound [4] [4] DELETE	Deletes the character at the cursor position.
Live Set Sound [5] [5] MODIFY	Changes the character at the cursor position to the desired one.
Live Set Sound [7] [7] REVERT	Reverts all characters to the unedited name.
Live Set Sound [8] [8] CLEAR	Deletes all characters.
[ENTER]	Terminates the edit operation, and then stores the data or saves the file.
[EXIT]	Terminates the edit operation.

Saving / Loading Data

In the File screens ([MENU] button → “File”), you can save/load the data of this instrument, including the entire system settings, entire Live Set, or each Live Set Sound to/from a USB flash drive.

NOTE

Before using a USB flash drive, be sure to read “Precaution when using the USB [TO DEVICE] terminal” (page 26).

Saving the settings to a USB flash drive

1. Connect a USB flash drive to the USB [TO DEVICE] terminal of this instrument.

2. Call up the File screen.

Select the [MENU] button → “File.”

3. Select the contents you wish to save.

The following file types can be saved to a USB flash drive.

File type	Description
Back Up File	All data including the system settings.
Live Set All File	All the Live Set Pages.
Live Set Page File	Currently selected Live Set Page.
Live Set Sound File	Currently selected Live Set Sound.

4. Perform the save operation.

Select “Save” and press the [ENTER] button to call up the screen for selecting the destination.

■ When overwriting the existing file

Select the desired file from the displayed list.

■ When saving as a new file

Select “New File.”

The “Save *** File” screen for editing file name appears. For details on name editing operations, refer to “Operations During Name Edit” (page 24).



File name edit screen

Press the [ENTER] button to execute saving. The messages “Saving..” → “Completed.” will appear on the screen, and then return to the Top screen.

Loading the settings from a USB flash drive

NOTICE

The Load operation overwrites any data previously existing in this instrument. Important data should always be saved to a USB flash drive connected to the USB [TO DEVICE] terminal.

1. Connect a USB flash drive to the USB [TO DEVICE] terminal of this instrument.

2. Call up the File screen.

Select the [MENU] button → “File.”

3. Select the contents you wish to load from the USB flash drive.

File type	Description
Back Up File (Extension: .Y0A)	All data including system settings.
Live Set All File (Extension: .Y0L)	All Live Set Pages.
Live Set Page File (Extension: .Y0P)	One Live Set Page. The file will be loaded to the currently selected Live Set Page.
Live Set Sound File (Extension: .Y0S)	One Live Set Sound. The file will be loaded to the currently selected Live Set Sound.

4. Select “Load” and press the [ENTER] button.

5. Select the file in the USB flash drive.

To cancel the loading operation, select “Cancel” and press the [ENTER] button.

6. Perform the load operation.

Select “Load All”/ “Load to ***” and then press the [ENTER] button. The messages “Loading..” → “Completed.” will appear on the screen, and then return to the Top screen.

NOTE

For file types other than a Live Set Sound file, you can select and load the one desired Live Set Sound included in the file. In that case, select “Load Live Set Sound” in step 6 to call up the screen for selecting the Live Set Sound in the file. Then select the desired data, and execute loading. The data is loaded into the currently selected Live Set Sound.

Precautions when using the USB [TO DEVICE] terminal

This instrument features a built-in USB [TO DEVICE] terminal. When connecting a USB device to the USB [TO DEVICE] terminal, be sure to handle the USB device with care. Follow the important precautions below.

NOTE

For more information about the handling of USB devices, refer to the owner's manual of the USB device.

■ Compatible USB devices

- USB flash drive

Other USB devices such as a USB hub, computer keyboard or mouse cannot be used.

The instrument does not necessarily support all commercially available USB devices. Yamaha cannot guarantee operation of USB devices that you purchase. Before purchasing a USB device for use with this instrument, please visit the following web page:

<https://download.yamaha.com/>

Although USB devices 2.0 to 3.0 can be used on this instrument, the amount of time for saving to or loading from the USB device may differ depending on the type of data or the status of the instrument.

NOTICE

The rating of the USB [TO DEVICE] terminal is a maximum of 5V/500mA. Do not connect USB devices having a rating above this, since this can cause damage to the instrument itself.

■ Connecting a USB device

When connecting a USB device to the USB [TO DEVICE] terminal, make sure that the connector on the device is appropriate and that it is connected in the proper direction.

NOTICE

- **Avoid connecting or disconnecting the USB device during playback/recording and file management operations (such as Save, Copy, Delete and Format), or when accessing the USB device. Failure to observe this may result in "freezing" of the operation of the instrument or corruption of the USB device and the data.**
- **When connecting then disconnecting the USB device (and vice versa), make sure to wait a few seconds between the two operations.**
- **Do not use an extension cable when connecting a USB device.**

■ Using USB flash drives

By connecting the instrument to a USB flash drive, you can save data you've created to the connected device, as well as read data from the connected device.

- **Number of USB flash drives that can be used**
Only one USB flash drive can be connected to the [USB TO DEVICE] terminal.

■ Formatting a USB flash drive

You should format the USB flash drive only with this instrument (page 41). A USB flash drive formatted on another device may not operate properly.

NOTICE

The format operation overwrites any previously existing data. Make sure that the drive you are formatting does not contain important data.

■ To protect your data (write-protect)

To prevent important data from being inadvertently erased, apply the write-protect provided with each USB flash drive. If you are saving data to the USB flash drive, make sure to disable write-protect.

■ Turning off the instrument

When turning off the instrument, make sure that the instrument is NOT accessing the USB flash drive by file management (such as during Save, Copy, Delete and Format operations). Failure to do so may corrupt the USB flash drive and the data.

Precautions when using the USB [TO HOST] terminal

When connecting the computer to the USB [TO HOST] terminal, make sure to observe the following points to avoid freezing the computer and corrupting or losing the data.

NOTICE

- **Use an AB type USB cable. USB 3.0 cables cannot be used.**
- **Execute the following before turning the power to the instrument on/off or plugging/unplugging the USB cable to/from the USB [TO HOST] terminal.**
 - **Quit any open application software on the computer.**
 - **Make sure that data is not being transmitted from the instrument. (Data is transmitted only by playing notes on the keyboard.)**
- **While the computer is connected to the instrument, you should wait for six seconds or more between these operations: (1) when turning the power of the instrument off then on again, or (2) when alternately connecting/disconnecting the USB cable.**

If the computer or the instrument freezes, restart the application software or the computer OS, or turn the power to the instrument off then on again.

Using with External Devices

By using the MIDI [IN]/[OUT] terminals and the USB [TO HOST] terminal, you can connect various kinds of external devices to this instrument.

- **MIDI [IN]/[OUT] terminals:** Connecting the instrument to an external MIDI device (synthesizer, tone generator module, etc.), and transmit/receive MIDI data.
- **USB [TO HOST] terminal:** Connecting the instrument to a computer or iPhone/iPad, and transmit/receive MIDI and audio data.

These can be combined for use with the instrument in various ways.

NOTE

Before connecting the USB [TO HOST] terminal to a computer or the like, be sure to read “Precautions when using the USB [TO HOST] terminal” on page 26.

Controlling this instrument from an external MIDI keyboard or stage piano

You can use the external MIDI keyboard instead of the keyboard of this instrument to play and control each Section of this instrument. To specify which Section/part will sound when you play an external MIDI keyboard, make settings via the [SETTINGS] button → “External Keyboard” (page 45).

You can also use these to recreate a two-manual organ, by setting only one of the UPPER/LOWER parts in the Organ Section to be controlled from an external MIDI keyboard. For example, if you want to play the UPPER part of the Organ Section with the keyboard of this instrument and play the LOWER part with an external MIDI keyboard, set “External Keyboard” to “2manualLo.”

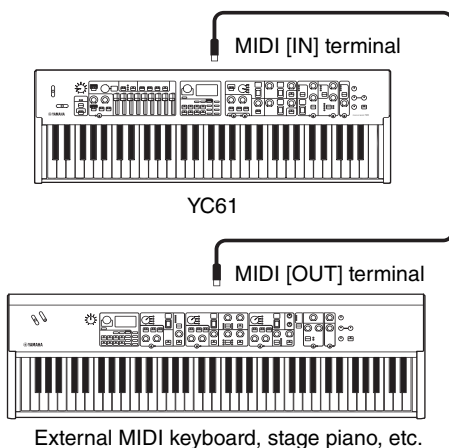

Controlling a synthesizer or tone generator module from this instrument

You can play the sounds of an external MIDI tone generator by playing on this instrument's keyboard.

You can also use the controllers of the Sections that is turned off to control external devices by setting the “MIDI Control” (page 37) to “Invert.”

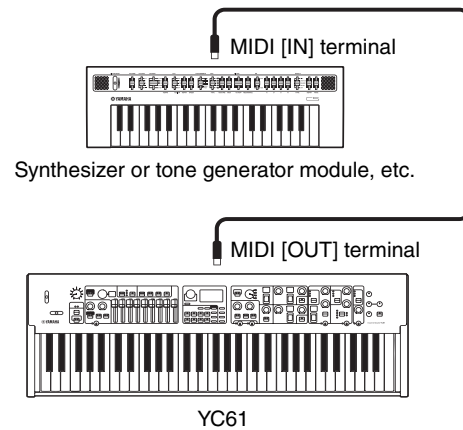

Using by connecting to a computer or an iPhone/iPad

By connecting to a computer or an iPhone/iPad, you can use this instrument for following usages:

■ Controlling this instrument from a computer or iPhone/iPad

You can play or control the Sections of this instrument from a DAW software etc. on your computer or iPhone/iPad. Audio data can also be transmitted/received.

■ Controlling a synthesizer or tone generator module from a computer or iPhone/iPad

By using the YC61 as a USB-MIDI interface, you can play the sound of other MIDI tone generator from a DAW software etc. on your computer or iPhone/iPad via this instrument. To do this, turn the setting of “MIDI Port” → “MIDI” to “Off” (page 36).

Setting the MIDI transmit and receive channels

To control a device using MIDI data, you must match the transmit channel on the controlling device and the receive channel on the controlled device.

You can change the transmit channel (Tx) and receive channel (Rx) on this instrument to any number. Make changes as necessary from the [MENU] button → “General” → “MIDI Settings” → “MIDI Channel” → “Tx”/“Rx.”

NOTE

- For details on setting the transmit channel of an external MIDI keyboard or the receive channel of an external MIDI tone generator, refer to the owner’s manual of that product.
- For details about MIDI channels, refer to page 30.

Setting the internal tone generator to not produce sound when the built-in keyboard is played

If you want for only the external tone generator connected to the MIDI [OUT] terminal or USB [TO HOST] terminal to produce sound when the keyboard of this instrument are played, you can lower the instrument’s volume, or turn off all the Sections, or set the value for Local Control under the [MENU] button → “General” → “Local Control” to “Off” (page 38).

Setting how the MIDI [IN]/[OUT] terminals are used (MIDI Port settings)

This instrument provides two MIDI ports with different purposes.

- **Port 1:** For communication between this instrument and an external device
- **Port 2:** For communication between a computer or the like and an external device

You can set whether the MIDI [IN]/[OUT] terminals are used as Port 1 or Port 2, from the [MENU] button → “General” → “MIDI Setting” → “MIDI Port” → “MIDI.”

■ Port 1: For communication between this instrument and an external device

Use this Port to control the tone generator of this instrument from an external device, or to control an external tone generator from this instrument.

If using the MIDI [IN]/[OUT] terminals as Port 1, set the value under the [MENU] button → “General” → “MIDI Setting” → “MIDI Port” → “MIDI” to “On.”

NOTE

By default, “MIDI Port” → “MIDI” is set to “On.” There is no need to change the settings except when using as Port 2 as shown below.

On the other hand, if you want to perform MIDI communication between this instrument and a computer connected to the USB [TO HOST] terminal, set the MIDI IN/OUT settings on the computer to “YC Series” (Port 1).

■ Port 2: For communication between a computer or the like and an external device

This Port is for using this instrument as a USB-MIDI interface. Use this port when you want to connect an external MIDI device without a USB terminal to a computer via this instrument.

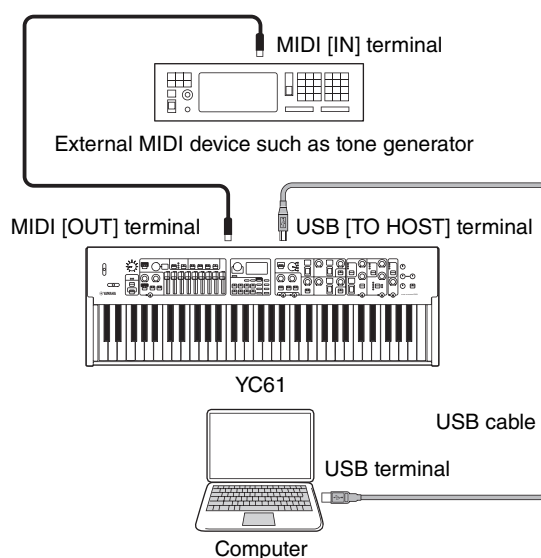

When using the MIDI [IN]/[OUT] terminals as Port 2, set the values under the [MENU] button → “General” → “MIDI Setting” → “MIDI Port” as follows.

- **USB:** On
- **MIDI:** Off

In addition, set the MIDI IN/OUT settings of a computer connected to the USB [TO HOST] terminal to the “MIDI IN 2 (YC Series)” and “MIDI OUT 2 (YC Series)” (Port 2).

Connecting to a computer

By connecting this instrument to your computer, you can use musical production applications such as DAW software to expand your musical possibilities. Here are some of the creative options you can explore.

- Using this instrument as an external tone generator or MIDI keyboard for DAW software.
- Recording your performance on this instrument in MIDI or audio format by DAW software on your computer.

A USB cable and the Yamaha Steinberg USB Driver are necessary to connect this instrument to the computer. Follow the instructions below to make the connection.

NOTE

Before connecting the USB [TO HOST] terminal to a computer, be sure to read “Precautions when using the USB [TO HOST] terminal” on page 26.

1. Download the latest Yamaha Steinberg USB Driver from the URL below.

<https://download.yamaha.com/>

Open “Manual Library,” select your language, and then input the model name in the “Model Name or Keyword” field and then click “Search.” Download the resulting file, and then extract it.

NOTE

- For details about the system requirements, refer to the URL above.
- The Yamaha Steinberg USB Driver may be revised and updated without prior notice. For details and the latest information, refer to the URL above.

2. Install the Yamaha Steinberg USB Driver on your computer.

Refer to the Installation Guide included in the downloaded file. When connecting the USB [TO HOST] terminal of this instrument and the computer by USB cable, refer to the figure below.

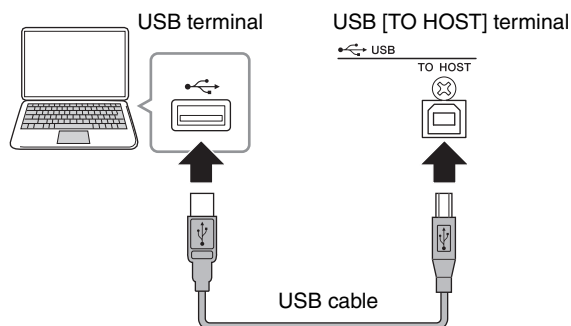

3. Set this instrument to send and receive MIDI data through the USB [TO HOST] terminal.

Set the value under the [MENU] button → “General” → “MIDI Settings” → “MIDI Port” → “USB” to “On.”

Connecting an iPhone or iPad

Connecting this instrument to an iPhone or iPad and using compatible apps allows you to more conveniently enjoy using this instrument. For details about how to connect the devices, refer to the “Smart Device Connection Manual,” which is available from the Yamaha website.

NOTICE

Be sure to place your iPhone or iPad on a stable surface to prevent it from falling over and being damaged.

NOTE

If using this instrument with an iPhone or iPad app, we recommend first putting the iPhone or iPad in Airplane mode and then turning the Wi-Fi on to avoid noise due to transmissions.

Smart Device Connection Manual

Access the website below and then open “Manual Library.” Select your language, and then input “iPhone/iPad” or the like in the “Model Name or Keyword” field and then click “Search.”

<https://download.yamaha.com/>

For details about smart devices and applications compatible with this instrument, refer to the following website.

<https://www.yamaha.com/kbdapps/>

USB Audio

There are two channels (one stereo channel) capable of handling USB audio for input and output, with a sampling rate of 44.1 kHz, 24 bit.

The audio input signal via the USB [TO HOST] terminal is output via the OUTPUT [L/MONO]/[R] jacks and the [PHONES] jack. The input level can be adjusted from the [MENU] button → “General” → “I/O Volume” → “USB Audio.”

The audio output signal via the USB [TO HOST] terminal is identical to the audio signal output via the OUTPUT [L/MONO]/[R] jacks and the [PHONES] jack.

NOTE

The audio signal input via the INPUT [L/MONO]/[R] jacks is output only from the OUTPUT [L/MONO]/[R] jacks and the [PHONES] jack of this instrument, and is not sent via the USB [TO HOST] terminal.

MIDI

Musical Instrument Digital Interface (MIDI) is a global standard designed to allow performance, Voice, and other data to be transferred between musical instruments. As such, reliable data communication is assured even between musical instruments and equipment from different manufacturers. In addition to data generated by playing the keyboard or selecting a Live Set Sound, a wide range of other data types can also be exchanged via MIDI. Using the powerful functionality provided by this technology, you can not only play other instruments using this instrument's keyboard and controllers, but you can also adjust the volume or the tone of each Section and adjust effect settings. In fact, practically all of the parameters that can be set using the instrument's control panel can also be remotely controlled from another MIDI device.

MIDI Channels

MIDI data can be transmitted and received on one of sixteen MIDI channels. Therefore, performance data for up to sixteen different instrument parts can be simultaneously exchanged over a single MIDI cable. MIDI channels are very similar in nature to TV channels, in that each TV station transmits its broadcasts over a specific channel. Your TV, for example, receives many different programs at the same time from different broadcasters, and you select which program to watch by choosing the corresponding channel.

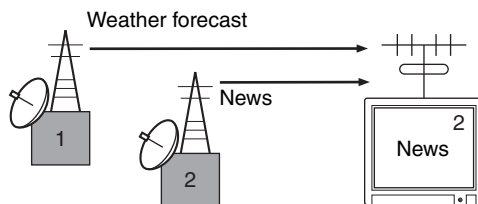

In much the same way, multiple transmitting devices in a MIDI system can each be set to send data on a separate channel (i.e., a MIDI transmit channel), which link with the system's receiving devices via MIDI cables. If a receiving device's MIDI channel (i.e., a MIDI receive channel) matches a MIDI Transmit channel, the receiving device will produce sound in response to the data sent by the corresponding transmitting device.

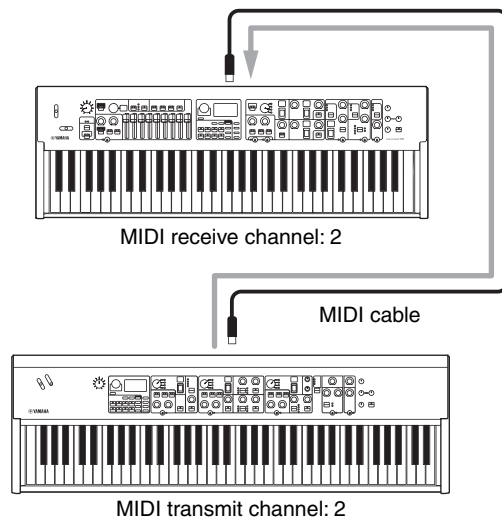

Special Operations List

The Special Operations are convenient shortcuts that help you quickly set important functions and parameters, especially for Live Set Sounds. To use them, hold down the [EXIT] button and operate the relevant controls listed below.

Location	Operation	Description
Center area of the panel	[EXIT] + [SETTINGS] button	Resets only those sound settings being edited to their default state. This operation does not overwrite the stored data of the Live Set Sound. You can create a new Live Set Sound from the initial value without erasing the stored settings. NOTE Unlike this special operation, the operation on [MENU] button → “Job” → “Live Set Manager” → “Initialize” initializes both the settings of being edited and the settings stored in the selected Live Set Sound (page 40).
	[EXIT] + [TOUCH] button	Calls up the Fixed Velocity setting screen directly. This is the same screen called up via the [MENU] button → “General” → “Keyboard / Pedal” → “Fixed Velocity.”
Organ	[EXIT] + LOWER/UPPER [L U] button	Reflects the actual position of all drawbars to the display of the LEDs (current setting) of the selected part (UPPER or LOWER).
	[EXIT] + VIBRATO/CHORUS type selection button	Switches the VIBRATO/CHORUS type in reverse order. This is useful when you want to return to the previous type.
Keys	[EXIT] + Keys [A B] button	Swaps the settings of the Key A and Key B Sections of the selected Live Set Sound. This is the same effect as [MENU] button → “Job” → “Section Manager” → “Swap Key A & Key B.”
	[EXIT] + Voice selection switch	Moves to the beginning of the next/previous subcategory, within the selected Voice category. This is useful when you want to select desired Voice in a category that contains many Voices, such as the “Others” category. For details on the Voice subcategories, refer to Voice List (page 58).
	[EXIT] + [EG FILTER] knob	Changes the “EG Control” or “Filter Control” of the selected Section (Key A or Key B) directly. This operation changes the “EG Control” if the “EG” lamp is lit, and the “Filter Control” if the “FILTER” lamp is lit. These are the same settings as the [SETTINGS] button → “Sound” → “Key A Settings”/“Key B Settings” → “EG Control”/“Filter Control.”
	[EXIT] + Effect type selection switch	Moves to the beginning of the next/previous category. This is useful when you want to quickly switch to the desired type. For details on categories of the Insertion Effects, see the “Insertion Effect Type List” (page 32).
	[EXIT] + EFFECT 1 [ON/OFF] button, or [EXIT] + EFFECT 2 [ON/OFF] button	Swaps the settings of the EFFECT 1 and EFFECT 2 in the selected Section (Key A or Key B). This is useful when you want to change the order in which the two insertion effects are applied. This is the same effect as the [MENU] button → “Job” → “Section Manager” → “Swap EFFECT 1/2.”
EFFECT	[EXIT] + Effect type selection switch	Moves to the beginning of the next/previous category. This is useful when you want to quickly switch to the desired type.
	[EXIT] + [RATE] knob	The “Tempo Delay Time” are changed directly only when this operation is performed while the “Tempo Delay” type is selected. This is the same setting as the [SETTINGS] button → “Sound” → “Tempo Delay Time.”
SPEAKER/AMP	[EXIT] + Effect type switching button	Switches the effect type of SPEAKER/AMP in reverse order. This is useful when you want to return to the previous type.

Insertion Effect Type List

*Keys: These effect types can only be used in the EFFECT 1 and EFFECT 2 on the Key A and Key B Sections.

*EFFECT: These effect types can only be used in the EFFECT Section.

Category	Type Name	Display	Description	Stereo/ Mono
Chorus	G Chorus	C1	Chorus effect that produces a deep sound with complex modulation. Turn the [DEPTH] knob to adjust the depth, and the [RATE] knob to adjust the speed.	Stereo
	SPX Chorus	C2	Chorus effect that uses a three-phase LFO to give more complex swell and spread. Turn the [DEPTH] knob to adjust the depth, and the [RATE] knob to adjust the speed.	Stereo
	Symphonic	C3	Chorus effect that features multiple sound modulation to give a greater sense of spaciousness. Turn the [DEPTH] knob to adjust the depth, and the [RATE] knob to adjust the speed.	Stereo
	816 Chorus	C4	Chorus effect that reproduces the detuned chorus effect characteristic of multiple FM tone generators on the famed TX816. Turn the [DEPTH] knob to adjust the depth, and the [RATE] knob to adjust the speed.	Stereo
Flanger	VCM Flanger	F1	Vintage flanger featuring a warm analog sound. Turn the [DEPTH] knob to adjust the depth and feedback amount, and the [RATE] knob to adjust the speed.	Stereo
	Cross FB Flanger	F2	Vintage flanger featuring a complex sound by cross feedback. Turn the [DEPTH] knob to adjust the depth and feedback amount, and the [RATE] knob to adjust the speed.	Stereo
Phaser	VCM Stereo Phaser	P1	Vintage phaser featuring a warm analog sound. Turn the [DEPTH] knob to adjust the depth and feedback amount, and the [RATE] knob to adjust the speed.	Stereo
	Small Phaser	P2	Vintage phaser that features a smooth and unique sweeping effect. Turn the [DEPTH] knob to switch the modulation type—which differs depending on whether the knob is set to the left or the right—and turn the [RATE] knob to adjust the speed.	Mono
	Max90	P3	Classic vintage phaser. Turn the [DEPTH] knob to adjust the effect strength, and the [RATE] knob to adjust the speed.	Mono
	Dual Phaser	P4	Vintage phaser that features two phasers with different characteristics. Turn the [DEPTH] knob to adjust the speed of the phaser 1, and the [RATE] knob to adjust the speed of the phaser 2.	Mono
Trem/Rtr	Tremolo	Tr	Effect that changes the volume cyclically. Turn the [DEPTH] knob to adjust the depth, and the [RATE] knob to adjust the speed.	Stereo
	Auto Pan	AP	Effect that moves the sound in the stereo field cyclically left and right. Turn the [DEPTH] knob to adjust the depth, and the [RATE] knob to adjust the speed.	Stereo
	Simple Rotary	Sr	Simple rotary speaker. Turn the [DEPTH] knob to adjust the volume and drive level, and the [RATE] knob to switch the rotation speed. The rotation speed is set to “Slow” when the [RATE] knob is turned to the left from center, and set to “Fast” when the knob is turned to the right from center.	Mono
Dist	British Combo	d1	Crunch distortion. Turn the [DEPTH] knob to adjust the amount of distortion, and the [RATE] knob to adjust the brightness.	Mono
	British Lead	d2	Hard rock type distortion. Use the [DEPTH] knob to adjust the amount of distortion, and the [RATE] knob to adjust the presence.	Mono
	Small Stereo	d3	Stereo distortion. Use the [DEPTH] knob to adjust the amount of distortion, and the [RATE] knob to adjust the presence.	Stereo
Comp	Compressor	Co	Stereo compressor. Use the [DEPTH] knob to adjust the depth, and the [RATE] knob to adjust the volume.	Stereo
Wah	Auto Wah	Aw	Wah that changes characteristics cyclically. Turn the [DEPTH] knob to adjust the amount of resonance, and the [RATE] knob to adjust the speed.	Stereo
	Touch Wah	To	Wah that changes characteristics in response to volume changes by keyboard touch. Turn the [DEPTH] knob to adjust the strength of the effect, and the [RATE] knob to adjust the amount of resonance.	Stereo

Category	Type Name	Display	Description	Stereo/ Mono
Wah	Pedal Wah	PE	Wah that is controlled by the pedal. Turn the [DEPTH] knob to adjust the amount of distortion, and the [RATE] knob to adjust the amount of resonance. By default, pedal wah control is assigned to FOOT CONTROLLER [2].	Stereo
Delay	Cross Delay	CD	Delay that alternates the delayed repeats between the left and right sides of the stereo image. Turn the [DEPTH] knob to adjust the depth and feedback amount, and the [RATE] knob to adjust the speed.	Stereo
	Tempo Delay (*EFFECT)	TD	Delay that can be applied to match the tempo of the song. Specify the Tempo and the note length (“Tempo Delay Time”), and delay will be applied at that length. The default setting of the Tempo Delay Time is 1/4 (quarter note). Turn the [DEPTH] knob to adjust the feedback level, and the [RATE] knob to adjust the tempo. You can also set the tempo by tapping the [TAP] button several times. NOTE You can set the note length by [EXIT] button + [RATE] knob operation, or from the [SETTINGS] → “Sound” → “Tempo Delay Time.”	Stereo
	Digital Delay (*Keys)	DD	Clean digital delay. Turn the [DEPTH] knob to adjust the depth and feedback amount, and the [RATE] knob to adjust the delay time. The maximum delay time is 1,486 ms.	Stereo
	Analog Delay	AD	Delay featuring a warm analog sound. Turn the [DEPTH] knob to adjust the feedback amount, and the [RATE] knob to adjust the delay time. The delay time is a maximum of 800 ms.	Stereo
	Looper Delay (*EFFECT)	LD	A special delay that provides a multiple echo/delay effect, repeating the sound for a short time for you to improvise with, like an audio looper. Turn the [DEPTH] knob to adjust the depth and feedback amount, and the [RATE] knob to adjust the delay time. The maximum delay time is 1,486 ms. When this type is selected, the EFFECT Section behaves differently from normal. <ul style="list-style-type: none"> The “Looper Delay” effect is applied after the SPEAKER/AMP Section. In addition, the effect of the REVERB Section is not applied to the delay sound. Pressing the [SELECT] button alternates between the two following states. <ul style="list-style-type: none"> All lit: The delay effect is applied to all the Organ, Key A, and Key B Sections. All off: The delay effect is not applied to any of the Sections. You can play without a delay effect, while keeping the delay sounds you played before switching this setting. 	Stereo
Reverb	Room Reverb	r1	Simulates the reverberation of a room. Turn the [DEPTH] knob to adjust the dry/wet balance, and the [RATE] knob to adjust the duration of the reverb effect.	Stereo
	Hall Reverb	r2	Simulates the reverberation of a hall. Turn the [DEPTH] knob to adjust the dry/wet balance, and the [RATE] knob to adjust the duration of the reverb effect.	Stereo
	Reverse Reverb	r3	Effect that simulates reverse playback of the Gate Reverb. Turn the [DEPTH] knob to adjust the dry/wet balance, and the [RATE] knob to adjust the duration of the effect.	Stereo
Lo-Fi	Lo-Fi	Lo	Effect that re-samples and degrades the input sound. Turn the [DEPTH] knob to adjust the volume threshold, and the [RATE] knob to adjust the sampling frequency. Turn each knob clockwise to make the sound more degraded and less clear.	Mono
Tech	Ring Modulator	r1	Effect that changes the input sound to a metallic sound. Turn the [DEPTH] knob to adjust the depth, and the [RATE] knob to adjust the frequency.	Stereo
	Slicer	SL	Effect that slices the input sound. Turn the [DEPTH] knob to adjust the gate time length, and the [RATE] knob to adjust the fineness of slicing.	Stereo
	LP Filter	LF	Filter that cuts sounds at frequencies higher than the cutoff frequency. Turn the [DEPTH] knob to adjust the cutoff frequency, and the [RATE] knob to adjust the resonance.	Stereo
Misc	Damper Resonance (*Keys)	dr	Effect that reproduces the sound spread produced by open strings while the damper pedal of a piano is pressed. Turn the [DEPTH] knob to adjust the dry/wet balance, and the [RATE] knob to adjust the damper opening degree.	Stereo
	Harmonic Enhancer	HE	Effect that adds harmonic overtones to the input sound to give the sound a little “sparkle” or an airy brightness. Turn the [DEPTH] knob to adjust the cutoff frequency of the high-pass filter, and the [RATE] knob to adjust the strength of the effect.	Stereo

EG/Filter Control Type List

You can change the expression of the sound in real time by operating the [EG FILTER] knob while playing phrases. This list explains the control types of each EG and Filter.

EG (Envelope Generator)

EG allows you to determine how the level of the sound changes in time. This lets you to reproduce a variety of sound characteristics of natural acoustic instruments—such as the quick attack and decay of percussion sounds, or the long release of sustained piano sound. The YC61 controls the following three characteristics with a single knob.

Attack	Determines the time which the sound reaches its maximum level after the key is played. The lower the value, the quicker the attack.
Decay	Determines the time it takes for the sound reaches its sustain level (a slightly lower level than maximum). The lower the value, the quicker the decay.
Release	Determines the time it takes for the sound decays to silence after the key is released. The lower the value, the quicker the release.

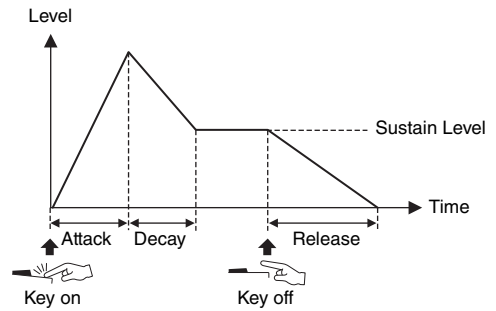

How these three characteristics change with a single knob operation is referred to as EG control type. The YC61 has 11 types. The type can be set using the [EXIT] button + [EG FILTER] knob operation, or from the “EG Control” (page 43). Graphs below show how the Attack, Decay, and Release change when the knob is turned from the center (= 64) to the left and right in each type.

Atk&Dcy&Rls A/B
Types which the Attack, Decay, and Release are all changed by the knob.

Atk&Dcy&Rls A

Atk&Dcy&Rls B

Attack/Decay/Release
Types which only one of Attack, Decay, and Release is changed by the knob.

Attack

Decay

Release

Atk&Rls A/B/Minus
Types which the Attack and Release are changed by the knob. “B” is suitable for making pad sounds. “Minus” enables creation of unusual sounds, since turning the knob clockwise reduces the release time.

Atk&Rls A

Atk&Rls B

Atk&Rls Minus

— Attack
— Decay
..... Release

Dcy&Rls
A type which the Decay and Release are changed by knob operation.

Dcy&Rls

Atk&Dcy A/B
Types which the Attack and Decay are changed by the knob. “B” has less change.

Atk&Dcy A

Atk&Dcy B

Filter

Filter is a function that changes the tone of a sound by passing or only a specific frequency range and cutting signals in other frequency ranges. The YC61 controls the following two characteristics with a single knob.

Cutoff

Determines the cutoff frequency of the filter (which frequency band signal or higher is cut), adjusting the brightness of the sound. Higher values result in a brighter sound.

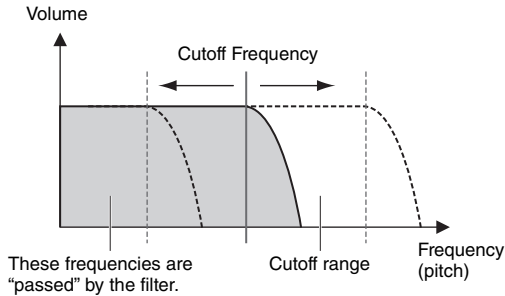

Resonance

Determines the amount of the resonance which raises the volume around the cutoff frequency. Higher values result in a more pronounced effect.

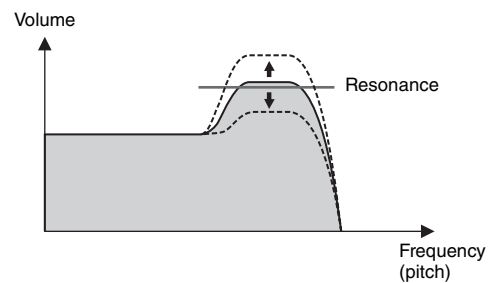

How these two characteristics change with a single knob operation is referred to as Filter control type. The YC61 has seven types. The type can be set using the [EXIT] button + [EG FILTER] knob operation, or from the “Filter Control” (page 43).

Graphs below show how the two parameters change when the knob is turned from the center (= 64) to the left and right in each type.

Flat Reso

A type which uses the knob to change only the Cutoff.

Flat Reso

Reso Plus

A type which increases the Resonance by turning the knob to the right.

Reso Plus

— Cutoff

— Resonance

Reso Minus A/B/C

Types which reduce the Resonance by turning the knob to the right. Characteristics of the Filter function are strongly emphasized, letting you create synthesizer-like sounds.

Reso Minus A

Reso Minus B

Reso Minus C

Reso Boost A/B

Types which increase the Resonance regardless of whether the knob is turned left or right. Characteristics of the Filter function are strongly emphasized, and the sound gets brighter when turning the knob to the right compared to the Reso Minus types.

Reso Boost A

Reso Boost B

MENU LIST

From the [MENU] button, you can configure various parameters and functions that affect the whole system of this instrument. The settings will be stored in this instrument.

Operation

1. Press the [MENU] button.
2. Use the Encoder dial and the [ENTER] button to select an item and display the settings screen.

NOTE

You can also use the LIVE SET buttons [1] to [6] to select the items directly. The LIVE SET buttons [1] to [6] correspond to the items in order from the top. The lamps for selectable buttons light up.

3. Use the Encoder dial to change and set the value or setting.
4. Press the [ENTER] button to return to the Top screen (Live Set Sound).

General

Function name		Description
Master Tune		Determines the tuning for the entire instrument. Settings: 414.72 Hz – 466.78 Hz Default: 440.00 Hz
MIDI Settings	MIDI Port	USB Determines whether to use (On) the USB [TO HOST] terminal for transmission/reception of MIDI messages, or not (Off). Default: On
		MIDI Determines whether to use (On) the MIDI [IN]/[OUT] terminals for the transmission/reception of MIDI messages with the tone generator of this instrument, or not (Off). When this is set to “On,” the terminals are used as Port 1 (message transmission/reception with the tone generator of this instrument). When this is set to “Off,” they are used as Port 2 (USB-MIDI interface). In this case, MIDI messages received by the MIDI [IN] terminal are output without alteration to USB Port 2 (MIDIOUT2 (YC Series)). MIDI messages received by the USB Port 2 (MIDIIN2 (YC Series)) are output without alteration to the MIDI [OUT] terminal. Default: On
MIDI Channel	Tx	Determines the MIDI transmit channel. When this is set to “Off,” MIDI messages are not transmitted. Settings: 1 – 16, Off Default: 1
	Rx	Determines the MIDI receive channel. When this is set to “All,” MIDI messages will be received over all channels. Settings: 1 – 16, All Default: 1

Function name	Description
MIDI Settings MIDI Control	<p>Determines the transmission of MIDI control messages.</p> <p>When this is set to “On,” MIDI messages corresponding to the controls on the instrument are transmitted when a setting is changed using the controls (knobs, etc.), allowing you to receive and record the operation information on DAW software or an external MIDI device.</p> <p>When this is set to “Invert,” MIDI messages are transmitted only when you use the controls of a Section that has been turned off, allowing you to control DAW software or an external MIDI device. For example, when you have created a Live Set Sound combining this instrument’s Organ Section and a DAW software’s strings sound, you can use the operators of the Key A/Key B Sections to control the volume or filters of the software strings.</p> <p>Default: Off</p> <p>NOTE</p> <ul style="list-style-type: none"> • When MIDI messages corresponding to controls are received by DAW software or the like, the settings of the corresponding controls are changed. • The assignment of MIDI messages to each control is fixed. If you want to control the parameters on DAW software from the instrument’s controls, perform configurations on the computer side so that messages corresponding to the controls are appropriately received. For details about the controls and their corresponding MIDI messages, refer to page 58. • MIDI messages for when the Modulation Lever and Bend Lever are operated are always sent, regardless of this setting. <p>■ MIDI Control = Off</p> <p>MIDI messages are not transmitted even when this instrument is operated.</p> <p>■ MIDI Control = On</p> <p>Corresponding MIDI messages are transmitted when parameters are changed using the controls on this instrument.</p> <p>NOTE</p> <p>Even when the Section [ON/OFF] switch or EFFECT 1/2 [ON/OFF] button is off, MIDI messages are transmitted if the control lamps are lit for enabling parameter changes, by the settings of “Display Lights” (page 39).</p> <p>■ MIDI Control = Invert</p> <p>Corresponding MIDI messages are transmitted only when controls in a Section where the Section [ON/OFF] switch is off are moved.</p> <p>NOTE</p> <ul style="list-style-type: none"> • When this is set to “Invert,” control lamps automatically light up regardless of the status of the Section [ON/OFF] switch. • When this is set to “Invert,” settings for “Display Lights” (Section, Ins Effect) cannot be made.
Tx/Rx Pgm Change	<p>Determines whether transmission/reception of Program Change messages between this instrument and external MIDI devices is enabled (On) or disabled (Off).</p> <p>Default: On</p>
Tx/Rx Bank Select	<p>Determines whether transmission/reception of Bank Select messages between this instrument and external MIDI devices is enabled (On) or disabled (Off).</p> <p>Default: On</p>
Controller Reset	<p>Determines whether to keep (Hold) or initialize (Reset) the values of controllers (Modulation Lever, Foot Controller, etc.) when switching between Live Set Sounds.</p> <p>When this is set to “Reset,” the controllers are reset to the default states (below) when switching between Live Set Sounds.</p> <ul style="list-style-type: none"> • Pitch Bend: Center • Modulation: Minimum • Expression: Maximum • Pedal Wah: Minimum <p>Default: Reset</p>

Function name		Description
Keyboard/ Pedal	Octave	Shifts the octave range of the keyboard up or down. Settings: -3 – +3 Default: +0
	Transpose	Transposes the pitch of the keyboard up or down in semitones. Settings: -12 – +12 Default: +0
	Touch Curve	Determines how actual velocities will be generated according to the strength with which you play notes on the keyboard (page 11). Settings: Normal, Soft, Hard, Wide, Fixed Default: Normal
	Fixed Velocity	Set this parameter to produce the same velocity, regardless of how hard or soft you play the keyboard. This parameter is only used when “Touch Curve” is set to “Fixed.” Settings: 1 – 127 Default: 64
	Sustain Pedal Type	Determines which type of sustain pedal is connected to the FOOT SWITCH [SUSTAIN] jack. Select “FC3A (HalfOn)” when you want to use a pedal with a Half Damper function. Settings: FC3A (HalfOn), FC3A (HalfOff), FC4A/FC5 Default: FC3A (HalfOn)
	Foot Switch Assign	Determines the Control Change number generated by using the Footswitch connected to the FOOT SWITCH [ASSIGNABLE] jack. Default: Live Set +
Local Control		Determines whether Local Control is on or off. When this is set to “Off,” this instrument’s tone generator is internally disconnected from the keyboard and controllers, and no sound will be produced when the keyboard is played. However, regardless of the setting here, performance information from this instrument’s keyboard and controllers is transmitted as MIDI messages, and this instrument’s tone generator will continue to produce sound in response to the MIDI messages received from MIDI input, depending on the MIDI settings. Default: On
I/O Volume	USB Audio	Determines the volume of USB Audio input. Settings: 0 – 127 Default: 64
	Output	Adjusts the final output sound level of the instrument. Settings: -24 dB – +0 dB – +24 dB Default: -6 dB
Auto Power Off		Determines whether to set the Auto Power Off function to “Enable” or “Disable.” Default: Disable

Control Panel

Function name		Description
Panel Lock Settings	Live Set	Determines whether the panel lock for each of the categories listed at left are enabled (On) or disabled (Off). Default: On
	Organ/Keys	
	Effect/Sp Amp/Reverb	
	Master EQ	
Display Lights	Section	Determines whether the indicator lamps of each Section are always lit (“On”) regardless the status of the corresponding Section [ON/OFF] switch. Default: Off NOTE When “MIDI Control” is set to “On” and the parameter is changed using the operator whose lamp is lit, the corresponding Control Change message is transmitted (page 37).
	Ins Effect	Determines whether the lamps in the EFFECT 1 and 2 areas of the Key A/Key B Sections are always lit (“On”) regardless the status of each of the EFFECT 1/2 [ON/OFF] buttons. Default: Off NOTE When “MIDI Control” is set to “On” and the parameter is changed using the operator whose lamp is lit, the corresponding Control Change message is transmitted (page 37).
	LCD SW	Determines whether to display (On) or not display (Off) the Top screen in the LCD. The various setting screens such as the MENU screens and the SETTINGS screens are always shown regardless of this setting. Default: On
	LCD Contrast	For adjusting the contrast of the LCD. Settings: 1 – 63 Default: 32
Advanced Settings	Drawbar Mode	Sets the conditions for a drawbar position to be reflected when the drawbar’s actual position and the LED display (setting called up) do not match. When this is set to “Jump,” the position of a drawbar is unconditionally reflected when that drawbar is moved. When this is set to “Catch,” the current setting will be held until the drawbar’s position matches (catches) the LED display. Once they have matched, the drawbar’s position will be reflected. Default: Jump
	Section Hold	When this is set to “Enable,” you can select another Live Set Sound and still maintain (hold) the current settings of the desired Sections. Push and hold the Section [ON/OFF] switch of a Section you want to maintain the settings of until the corresponding lamp flashes to put that Section in the Hold status. To release Section Hold, push the Section [ON/OFF] switch again. For example, to keep reverb settings during your performance regardless of the Live Set Sounds you change, set this item to “Enable” and then push and hold the REVERB Section [ON/OFF] switch. Default: Disable
	Live Set View Mode	Determines whether to maintain the Live Set View (Keep) or automatically return to the Top screen (Close) when switching between Live Set Sounds. When this is set to “Keep,” the names of eight sets of Live Set Sounds are always displayed. Default: Close
	Value Indication	Determines whether to show (On) or not show (Off) the values on the LCD when the values for the knobs of each Section are changed. Default: On
	SW Direction	Determines whether to operate the Voice selection switch and the Effect type selection switches in ascending order (Default) or in descending order (Reverse). Default: Default

Function name		Description
Advanced Settings	EG/Filter Reset	Determines whether to reset (On) or maintain without resetting (Off) the parameters of EG and FILTER when Voices are switched in the Key A/Key B Sections. Default: On
System Settings	Power On Sound	Determines which Live Set Sound is shown when this instrument is turned on. Default: 1-1
	MIDI Device Number	Determines the MIDI device numbers. The device number of this instrument must match the device number of the external MIDI device when transmitting/receiving Bulk Dump data, Parameter Changes, or other System Exclusive messages. Settings: 1 – 16, All, Off Default: All
	MIDI Control Delay	Adjusts the transmission timing for MIDI control messages transmitted when switching between Live Set Sounds. You may need to make adjustments to this when the application on your computer does not receive messages correctly. Settings: 0 – 1500 msec Default: 0 msec

Job

Function name		Description	
Live Set Manager	Swap	Swaps the stored data of the currently selected Live Set Sound with another user-specified Live Set Sound.	
	Copy	Copies the stored data of the currently selected Live Set Sound to another user-specified Live Set Sound.	
	Initialize	Resets the stored data of the currently selected Live Set Sound to its default status.	
Section Manager	Copy	Organ	Copies the settings of the Organ Section of the Live Set Sound currently being edited.
		Key A	Copies the settings of the Key A Section of the Live Set Sound currently being edited.
		Key B	Copies the settings of the Key B Section of the Live Set Sound currently being edited.
		Effect	Copies the settings of the EFFECT Section of the Live Set Sound currently being edited.
		Speaker Amp	Copies the settings of the SPEAKER/AMP Section of the Live Set Sound currently being edited.
	Paste	Organ	Pastes the copied settings. The paste function cannot be executed when nothing has been copied.
		Key A	Pastes between different Sections are only possible when pasting from Key A to Key B, or from Key B to Key A.
		Key B	
		Effect	
		Speaker Amp	
Swap Key A & Key B	Swaps the settings of the Key A Section and the Key B Section of the currently being edited Live Set Sound. NOTE This job can also be executed using the [EXIT] button and the Keys [A B] button.		

Function name		Description
Section Manager	Initialize	Organ Initializes all the settings under [SETTINGS] → “Sound” → “Organ Settings” of the Live Set Sound currently being edited.
		Rotary Speaker Initializes all the settings under [SETTINGS] → “Sound” → “Rotary Speaker” of the Live Set Sound currently being edited.
		FM Unison Initializes all the settings under “FM Unison” of the desired Section, of the Live Set Sound currently being edited. <ul style="list-style-type: none"> • Key A: [Settings] → “Sound” → “Key A Settings” → “FM Unison” • Key B: [Settings] → “Sound” → “Key B Settings” → “FM Unison”
Edit Recall	Recall	Recalls the last edited state of the currently selected Live Set Sound. If, while editing a Live Set Sound you have not yet stored, you select a different Live Set Sound and then return to the one being edited, the latest stored version will be called up instead of the latest edited status. If this happens, execute this function to restore the latest edited status of the Live Set Sound. NOTICE The latest edited status for each Live Set Sound will be lost when this instrument is turned off.
Menu Initialize		Resets the settings of MENU screens to the default values.
Factory Reset		Restores this instrument to its default (factory) condition.

File

Function name		Description
Back Up File	Save	Saves all the data stored in this instrument including the system settings to a USB flash drive as a “Back Up File” (with the extension: .Y0A).
	Load (*)	Loads the data saved as a “Back Up File” from a USB flash drive to this instrument.
Live Set All File	Save	Saves all the Live Set data stored in this instrument to a USB flash drive as a “Live Set All File” (with the extension: .Y0L).
	Load (*)	Loads the data saved as a “Live Set All File” from a USB flash drive to this instrument.
Live Set Page File	Save	Saves the currently selected Live Set Page stored in this instrument to a USB flash drive as a “Live Set Page File” (with the extension: .Y0P).
	Load (*)	Loads the data saved as a “Live Set Page File” from a USB flash drive to this instrument.
Live Set Sound File	Save	Saves the currently selected Live Set Sound stored in this instrument to a USB flash drive as a “Live Set Sound File” (with the extension: .Y0S).
	Load	Loads the data saved as a “Live Set Sound File” from a USB flash drive to this instrument.
File Utility	Rename	Changes the name of a file in a USB flash drive.
	Delete	Deletes a file in a USB flash drive.
	Format	Formats (initializes) a USB flash drive. Formatting is required to use a new USB flash drive for the File-related functions of this instrument. NOTICE When a USB flash drive is formatted, all of its content will be deleted. Make sure before formatting that the USB flash drive contains no irreplaceable data.

* You can also load the desired single Live Set Sound from a file containing multiple Live Set Sounds such as the Backup file, Live Set file, and Live Set Page file (page 25).

Version Info

Shows the versions of this instrument’s software and firmware, as well as its copyright information.

SETTINGS LIST

From the [SETTINGS] button, you can configure and store the various settings of the currently selected Live Set Sound. The settings made here will all be stored in the Live Set Sound.

Operation

1. Press the [SETTINGS] button.
2. Use the Encoder dial and the [ENTER] button to select an item and display the settings screen.

NOTE

If there are six or fewer items displayed on the screen, you can also use the LIVE SET buttons [1] to [6] to select the items directly. The LIVE SET buttons [1] to [6] correspond to the items in order from the top. The lamps for selectable buttons light up.

3. Use the Encoder dial to change and set the value or setting.
4. Press the [ENTER] button to return to the Top screen (Live Set Sound).

Sound

Function name	Description
Organ Settings	Determines the detailed settings for the Organ Section. Items marked with an asterisk (*) can be configured only when the VCM Organ type (H1-H3) is selected. If at least one of the items marked with (*) is changed from the default, a “+” will be displayed on the upper right of “H1”-“H3” on the Top screen.
Leak Level*	Adjusts the volume of the leakage sound (sound leaked from the tonewheel to the electric circuit). Settings: 0 – 127 Default: 64
KeyClick Level*	Determines the volume of the key click sound produced when you press a key. Settings: 0 – 127 Default: 64
Perc. Link to 1feet*	Determines the operation of the [1'] (one foot) drawbar when switching the PERCUSSION on or off. <ul style="list-style-type: none"> • On: When PERCUSSION is turned on, the sound of the [1'] drawbar stops. • Off: The [1'] drawbar generates sound regardless of whether PERCUSSION is on or off. Default: On
Expression Type	Determines the position in the organ’s signal path where the expression pedal is applied. <ul style="list-style-type: none"> • Drive+Vol: The pedal effect is applied to the pre-amplifier in the Organ. Operating the pedal changes both the volume and the distortion of the Organ sound. If the VCM Organ type is selected, this faithfully reproduces the effect of the expression pedal on a vintage organ. • Volume: The pedal effect is applied directly before the REVERB Section after the Organ sound is generated. Operating the pedal changes the volume, but not the distortion, of the Organ sound. Default: Drive+Vol

Function name	Description
Key A Settings/ Key B Settings	<p>Monopoly</p> <p>Selects whether to play the Section as monophonic (Mono) or polyphonic (Poly). When set to “Mono,” the  icon is displayed to the right of the Section name (A, B) on the Top screen.</p> <p>Default: Poly</p>
Portamento	<p>Determines settings regarding the portamento function, which continuously changes the sound from one played note to the next. This can only be set when “Mono/Poly” is set to “Mono.”</p>
Switch	<p>Determines whether the portamento effect is applied (On) or not (Off).</p> <p>Default: Off</p>
Time	<p>Determines the time (speed) that it takes for the portamento effect to shift in pitch between notes.</p> <p>Settings: 0 – 127 Default: 64</p>
Mode	<p>Determines how the portamento effect should be applied depending on how you play the keys.</p> <ul style="list-style-type: none"> • Full-time: The portamento effect is always applied. • Fingered: The portamento effect is applied only when you play legato performances (playing a key while still holding the previous key). <p>Default: Full-time</p>
Time Mode	<p>Determines the time standard for portamento pitch shifts.</p> <ul style="list-style-type: none"> • Rate: The pitch shifts at a speed corresponding to the distance between sounds (notes). The further the pitches between the two sounds, the more time it takes. • Time: The pitch shifts over a particular amount of time, regardless of how far apart the pitches between the two sounds are. <p>Default: Rate</p>
FM Unison	<p>Determines the settings for creating a sense of thickness and spaciousness in an FM tone generator Voice. This setting is available only when a Voice having “FM” in its name is selected.</p>
Mode	<p>Selects whether, when one note is played, to generate one note (Off), two notes simultaneously (2 Unison), or four notes simultaneously (4 Unison). When set to “2 Unison” or “4 Unison,” a “+” will be displayed on the upper right of “FM” in the Voice name on the Top screen.</p> <p>Default: Off</p>
Detune	<p>Determines the difference in pitch between the two or four notes, which affects the degree of thickness of to the sound.</p> <p>Settings: 0 – 15 Default: 0</p>
Spread	<p>Determines the difference in panning between the two or four notes, which affects the degree of widening of to the sound.</p> <p>Settings: 0 – 15 Default: 0</p>
EG Control	<p>Selects the EG control type. For details on the types that can be selected, see “EG/Filter Control Type List” (page 34).</p> <p>Default: Atk&Dcy&Rls A</p>
Filter Control	<p>Selects the Filter control type. For details on the modes that can be selected, see “EG/Filter Control Type List” (page 34).</p> <p>Default: Flat Reso</p>



Function name		Description
Rotary Speaker		Determines the detailed operations of the VCM Rotary Speaker types (RtrA and RtrB types of the SPEAKER/AMP Section).
Level	Horn	Determines the volume of the horn (treble). Settings: 0 – 127 Default: 64
	Rotor	Determines the volume of the rotor (bass). Settings: 0 – 127 Default: 64
Background Noise	Switch	Determines whether to include (On) or not include (Off) simulated background noise. Default: On
	Level	Determines the volume of the background noise. Settings: 0 – 127 Default: 64
Stereo/Mono		Determines whether to use stereo or monaural output for RtrA and RtrB. Default: Stereo
Speed		Determines the speed for the horn (treble) and rotor (bass) for the Slow and Fast states of the rotary speaker.
	Horn Fast	Settings: 209.4 – 817.6 rpm Default: 413.8 rpm
	Rotor Fast	Settings: 189.3 – 736.8 rpm Default: 373.5 rpm
	Horn Slow	Settings: 23.0 – 89.6 rpm Default: 45.4 rpm
	Rotor Slow	Settings: 22.7 – 88.3 rpm Default: 44.8 rpm
Acceleration		Determines the speed of acceleration and deceleration for the horn (treble) and rotor (bass) of the rotary speaker.
	Horn Acceleration	Settings: 0.21 – 2.00 Default: 1.30
	Rotor Acceleration	Settings: 0.21 – 2.00 Default: 1.00
	Horn Deceleration	Settings: 0.21 – 2.00 Default: 1.30
	Rotor Deceleration	Settings: 0.21 – 2.00 Default: 1.00
Function	Transpose	Transposes the pitch in semitone steps. Settings: -12 – +12 Default: +0 NOTE This setting does not affect MIDI output data.
	Split Point	Determines the key position when splitting the keyboard into left hand and right hand sections. The set value becomes the lowest note of the right hand section. Settings: C#-2 – G8 Default: G2

Function name	Description
Tempo Delay Time	<p>Determines the delay time in note lengths relative to the tempo for the “Tempo Delay” effect.</p> <p>Settings: 1/32 Tri. – 1/2</p> <p>Default: 1/4</p> <p>NOTE</p> <p>You can change the tempo used for calculating the delay time by setting it with the [TAP] button or the [RATE] knob in the EFFECT Section.</p>

External Keyboard

Determines the generation of sound for each Section when the YC61 receives performance information (key-on, key-off) MIDI messages from an external MIDI device. You can make settings so that combine the YC61 with an external keyboard for a two-manual organ, or performing only the Key A and/or Key B Sections on an external keyboard, etc.

NOTE

For Sections/parts that are set to generate sound only when playing an external keyboard, display of the Split on the Top screen changes from  to .

Function name	Description
---------------	-------------

- | | |
|-------|--|
| Organ | <ul style="list-style-type: none"> • Ext+Int: Sound is generated for both key-on signals received from an external MIDI device and performance on this instrument’s keyboard. • ExtOnly: Sound is generated only for key-on signals received from an external MIDI device. Sound is not generated when the keyboard on this instrument is played. • 2ManualUp: This setting is for performances on a two-manual organ. The UPPER part generates sound for key-on signals received from an external MIDI device, and the LOWER part generates sound when the keyboard on this instrument is played. • 2ManualLo: This setting is for performances on a two-manual organ. The LOWER part generates sound for key-on signals received from an external MIDI device, and the UPPER part generates sound when the keyboard on this instrument is played. • Off: Sound is not generated for key-on signals received from an external MIDI device. Sound is generated when the keyboard on this instrument is played. |
|-------|--|

Default: Ext+Int

Connection examples

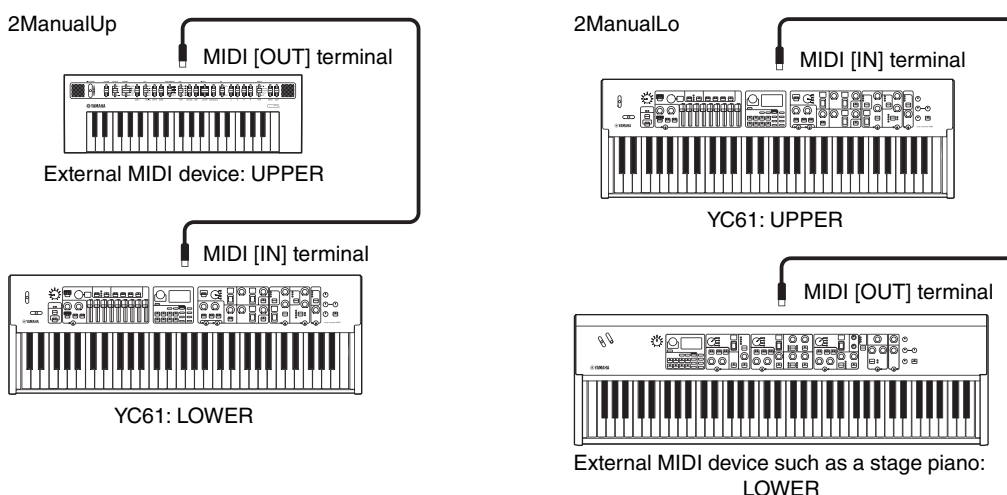

NOTE

When “2ManualUp” or “2ManualLo” is set, the settings of the Organ Section Split become invalid, and the lamps for the SPLIT [L U] button both automatically light.

Function name	Description
---------------	-------------

Key A

- **Ext+Int:** Sound is generated for both key-on signals received from an external MIDI device and performance on this instrument's keyboard.
- **ExtOnly:** Sound is generated only for key-on signals received from an external MIDI device. Sound is not generated when the keyboard on this instrument is played.
- **Off:** Sound is not generated for key-on signals received from an external MIDI device. Sound is generated when the keyboard on this instrument is played.

Default: Ext+Int

Connection example

Organ = Off, Key A = Off, Key B = ExtOnly

Key B

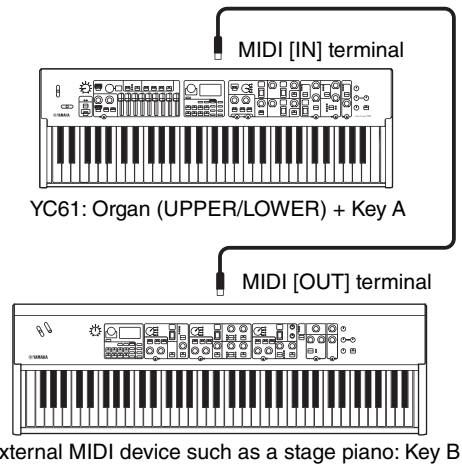

Master Keyboard

This function is for using the YC61 as a master keyboard. It allows the keyboard to be split into as many as four different zones, each of which can control separate sounds of an external tone generator. For example, you can make a Live Set Sound combining Voices from this instrument and the connected external tone generators, or a Live Set Sound composed with Voices of external tone generators only.

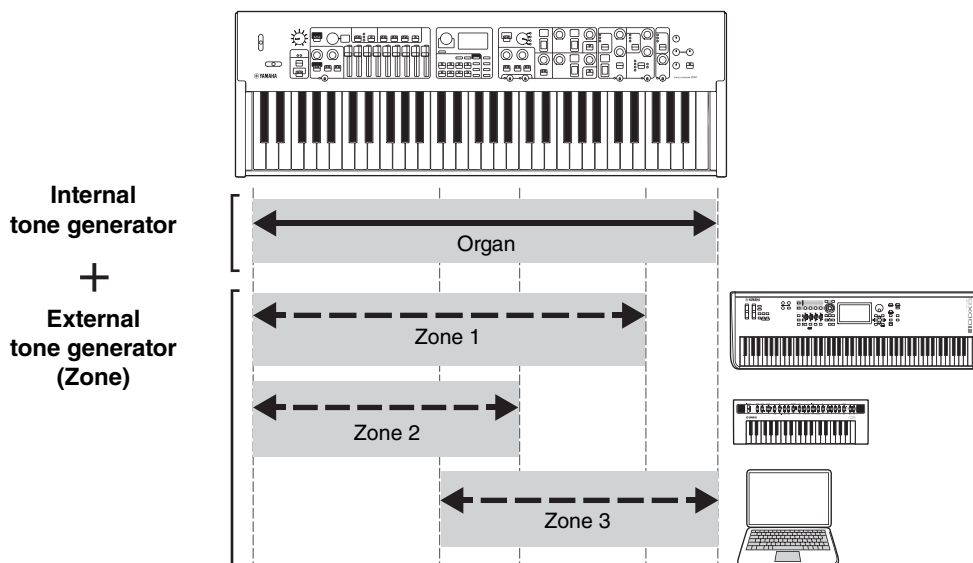

Function name	Description														
Mode SW	Switches the Master Keyboard Mode settings. When “On” is selected, the Master Keyboard Mode is enabled, and the MET indication appears on the Top screen. Default: Off														
Advanced Zone SW	Switches the setting range of Master Keyboard Mode. When “On” is selected, you can make detailed settings. Default: Off NOTE When “Off” is selected, the detailed settings items marked with asterisk (*) will not be displayed.														
Zone Settings → Zone 1–4 *: Detailed settings	<table border="1"> <tbody> <tr> <td>Zone SW</td> <td>Determines whether to enable (On) or disable (Off) the currently selected zone. Default: Zone 1 = On, Zone 2 – 4 = Off</td> </tr> <tr> <td>Tx Channel</td> <td>Determines the MIDI transmit channel for the currently selected zone. Settings: 1 – 16 Default: Zone 1 = 1, Zone 2 = 2, Zone 3 = 3, Zone 4 = 4</td> </tr> <tr> <td>Octave Shift</td> <td>Shifts the pitch of the currently selected zone in units of one octave. Settings: -3 – +3 Default: +0</td> </tr> <tr> <td>Transpose</td> <td>Transposes the pitch of the currently selected zone in semitone steps. Settings: -11 – +11 Default: +0</td> </tr> <tr> <td>Note Limit Low</td> <td>Determines the lowest key that generates sound in the currently selected zone. Default: C -2</td> </tr> <tr> <td>Note Limit High</td> <td>Determines the highest key that generates sound in the currently selected zone. Default: G8</td> </tr> <tr> <td>Bank MSB*</td> <td>Determines the Bank Select MSB to be sent as a MIDI message to the external tone generator played by the currently selected zone upon selection of a Live Set Sound. Default: 0</td> </tr> </tbody> </table>	Zone SW	Determines whether to enable (On) or disable (Off) the currently selected zone. Default: Zone 1 = On, Zone 2 – 4 = Off	Tx Channel	Determines the MIDI transmit channel for the currently selected zone. Settings: 1 – 16 Default: Zone 1 = 1, Zone 2 = 2, Zone 3 = 3, Zone 4 = 4	Octave Shift	Shifts the pitch of the currently selected zone in units of one octave. Settings: -3 – +3 Default: +0	Transpose	Transposes the pitch of the currently selected zone in semitone steps. Settings: -11 – +11 Default: +0	Note Limit Low	Determines the lowest key that generates sound in the currently selected zone. Default: C -2	Note Limit High	Determines the highest key that generates sound in the currently selected zone. Default: G8	Bank MSB*	Determines the Bank Select MSB to be sent as a MIDI message to the external tone generator played by the currently selected zone upon selection of a Live Set Sound. Default: 0
Zone SW	Determines whether to enable (On) or disable (Off) the currently selected zone. Default: Zone 1 = On, Zone 2 – 4 = Off														
Tx Channel	Determines the MIDI transmit channel for the currently selected zone. Settings: 1 – 16 Default: Zone 1 = 1, Zone 2 = 2, Zone 3 = 3, Zone 4 = 4														
Octave Shift	Shifts the pitch of the currently selected zone in units of one octave. Settings: -3 – +3 Default: +0														
Transpose	Transposes the pitch of the currently selected zone in semitone steps. Settings: -11 – +11 Default: +0														
Note Limit Low	Determines the lowest key that generates sound in the currently selected zone. Default: C -2														
Note Limit High	Determines the highest key that generates sound in the currently selected zone. Default: G8														
Bank MSB*	Determines the Bank Select MSB to be sent as a MIDI message to the external tone generator played by the currently selected zone upon selection of a Live Set Sound. Default: 0														

Function name	Description
Zone Settings → Zone 1–4 *: Detailed settings	Bank LSB* Determines the Bank Select LSB to be sent as a MIDI message to the external tone generator played by the currently selected zone upon selection of a Live Set Sound. Default: 0
	Program Change* Determines the Program Change Number to be sent as a MIDI message to the external tone generator played by the currently selected zone upon selection of the Live Set Sound. Default: 1
	Volume* Determines the volume to be sent as a MIDI message to the external tone generator played by the currently selected zone upon selection of a Live Set Sound. Default: 100
	Pan* Determines the panning to be sent as a MIDI message to the external tone generator played by the currently selected zone upon selection of a Live Set Sound. Default: C
	Tx SW Note* Determines whether to transmit (On) or not transmit (Off) MIDI note messages to the external tone generator played by the currently selected zone. Default: On
	Tx SW Bank* Determines whether to transmit (On) or not transmit (Off) MIDI Bank Select messages to the external tone generator played by the currently selected zone. Default: On
	Tx SW Program* Determines whether to transmit (On) or not transmit (Off) MIDI Program Change messages to the external tone generator played by the currently selected zone. Default: On
	Tx SW Volume* Determines whether to transmit (On) or not transmit (Off) MIDI volume messages to the external tone generator played by the currently selected zone. Default: On
	Tx SW Pan* Determines whether to transmit (On) or not transmit (Off) MIDI Pan messages to the external tone generator played by the currently selected zone. Default: On
	Tx SW PB* Determines whether to transmit (On) or not transmit (Off) MIDI Pitch Bend messages to the external tone generator played by the currently selected zone. Default: On
	Tx SW Mod* Determines whether to transmit (On) or not transmit (Off) MIDI Modulation messages to the external tone generator played by the currently selected zone. Default: On
	Tx SW Sustain* Determines whether to transmit (On) or not transmit (Off) MIDI Sustain messages to the external tone generator played by the currently selected zone. Default: On
	Tx SW FS* Determines whether to transmit (On) or not transmit (Off) MIDI Footswitch messages to the external tone generator played by the currently selected zone. Default: On
	Tx SW FC1* Determines whether to transmit (On) or not transmit (Off) MIDI messages for FOOT CONTROLLER [1] to the external tone generator played by the currently selected zone. Default: On
Tx SW FC2* Determines whether to transmit (On) or not transmit (Off) MIDI messages for FOOT CONTROLLER [2] to the external tone generator played by the currently selected zone. Default: On	

Controllers

Function name		Description	
Bend Lever	Mode	Switches the operation mode of the Bend Lever. <ul style="list-style-type: none"> • Pitch Bend: Operates as a Pitch Bend controller. • Rotary S/F: Switches between slow and fast for the rotary speaker of the SPEAKER/AMP Section. Moving the lever in either direction produces the same effect as pressing the ROTARY SPEAKER [Slow Fast] button. Default: Pitch Bend	
	Pitch Bend Range	Organ	Determines the pitch bend range in semitone steps. This can be set individually for each Voice Section.
		Key A	Settings: -24 – +0 – +24 Default: +2
Modulation Lever	Assign	Determines the function to be assigned to the Modulation Lever. You can assign Control Change numbers 1 to 119 as well as the USB Audio volume. Settings: Off, 1 – 63, 65, 67 – 119, USB Audio Volume Default: 1	
	Limit Low	Determines the lower limit for the Modulation Lever values. Settings: 0 – 127 Default: 0	
	Limit High	Determines the higher limit for the Modulation Lever values. Settings: 0 – 127 Default: 0	
	P.Mod Depth	Organ	Determines the depth of the vibrato effect applied to keyboard notes. This can be set individually for each Voice Section. Settings: 0 – 127 Default: 10
		Key A	NOTE
		Key B	This can be set for the Organ Section only when the FM tone generator organ type (F1 to F3) is selected.
P.Mod Speed	Organ	Determines the speed of the vibrato effect applied to keyboard notes. This can be set individually for each Voice Section. Settings: +64 – +0 – +63 Default: +0	
	Key A	NOTE	
	Key B	This can be set for the Organ Section only when the FM tone generator organ type (F1 to F3) is selected.	
Foot Controller 1	Assign	Determines the Control Change number to be assigned to a foot controller (sold separately) connected via the FOOT CONTROLLER [1] jack. Settings: Off, 1 – 63, 65, 67 – 119, USB Audio Volume Default: 11 (Expression)	
	Limit Low	Determines the lower limit value for a foot controller (sold separately) connected to the FOOT CONTROLLER [1] jack. Settings: 0 – 127 Default: 0	
	Limit High	Determines the upper limit value for a foot controller (sold separately) connected to the FOOT CONTROLLER [1] jack. Settings: 0 – 127 Default: 127	

Function name		Description	
Foot Controller 2	Assign	Determines the Control Change number to be assigned to a foot controller (sold separately) connected to the FOOT CONTROLLER [2] jack. Settings: Off, 1 – 63, 65, 67 – 119, USB Audio Volume Default: 4 (Pedal Wah)	
	Limit Low	Determines the lower limit value for a foot controller (sold separately) connected to the FOOT CONTROLLER [2] jack. Settings: 0 – 127 Default: 0	
	Limit High	Determines the upper limit value for a foot controller (sold separately) connected to the FOOT CONTROLLER [2] jack. Settings: 0 – 127 Default: 127	
Sustain Pedal	Mode	Switches the operation mode of a sustain pedal (sold separately) connected to the FOOT SWITCH [SUSTAIN] jack. <ul style="list-style-type: none"> • Sustain: Operates as a sustain pedal. • Rotary S/F: Switches between slow and fast for the rotary speaker of the SPEAKER/AMP Section. Pressing the pedal produces the same effect as pressing the ROTARY SPEAKER [Slow Fast] button. Default: Sustain	
Receive SW	Expression	Organ	Determines whether each Voice Section receives (On) or ignores (Off) the corresponding MIDI messages received from external devices or the messages generated by operating the footswitch or foot controller. Default: On
		Key A	
		Key B	
	Sustain	Organ	
		Key A	
		Key B	
	Sostenuto	Organ	
		Key A	
		Key B	
	Soft	Key A	
		Key B	

Drawbar Color

Function name	Description
Upper	Determines the color of the drawbar LEDs. This can be set individually for the UPPER and LOWER parts.
Lower	Settings: White, Red, Yellow, Green, Cyan, Blue, Magenta Default: Upper = White, Lower = Red

Name

Determines the names of Live Set Sounds. For details on editing Live Set Sound names, refer to “Editing File Names/Live Set Sound Names” (page 24).

NOTE

To store the edited names, you'll need to use the Store operation (page 12).

Appendix

Display Messages

LCD indication	Description
Auto power off disabled.	This message appears when Auto Power Off is disabled.
Completed.	The specified load, save, format, or other Job has been completed.
Connecting to USB device...	Currently recognizing the USB flash drive connected to the USB [TO DEVICE] terminal.
Device number is off.	Bulk data cannot be transmitted/received because the device number is off.
Device number mismatch.	Bulk data cannot be received because the device numbers do not match.
File or folder already exists.	A file/folder having the same name as the one you are about to save already exists.
File or folder path is too long.	The file or folder you tried to access cannot be accessed because the maximum amount of characters indicating the path has been exceeded.
Illegal bulk data.	An error occurred while receiving a Bulk data or Bulk Request message.
Illegal file name.	The specified file name is invalid. Try entering a different name.
Illegal file.	The specified file is unusable by this instrument or cannot be loaded.
Incompatible USB device.	USB device which cannot be used with this instrument has been connected to the USB [TO DEVICE] terminal.
MIDI buffer full.	Failed to process the MIDI data because too much data was received at one time.
MIDI checksum error.	An error occurred when receiving bulk data.
No device.	Device is not connected.
No read/write authority to the file.	Indicates that you do not have the authority to read/write the file.
Now receiving MIDI bulk data...	Indicates this instrument is receiving MIDI bulk data.
Now transmitting MIDI bulk data...	Indicates this synthesizer is transmitting MIDI bulk data.
Please reboot to maintain internal memory.	Reboot this instrument to restore the internal memory.
Push [PANEL LOCK] Button.	Push the [PANEL LOCK] button to disengage panel lock.
Unsupported USB device.	This message appears if the plugged-in USB flash drive is either unformatted or formatted in a way that this instrument does not support. Please format the USB device using this instrument.
USB connection terminated.	Communication with the USB device has been shut down because of the overcurrent to the USB device. Disconnect the device from the USB [TO DEVICE] terminal, and then turn on the power of the instrument.
USB device is full.	The USB flash drive is full and no more data can be saved. Use a new USB flash drive, or make space by erasing unwanted data from the storage device.
USB device is write-protected.	This message appears when you have attempted to write to a protected USB flash drive.
USB device read/write error.	An error occurred while reading or writing to/from a USB flash drive.

Troubleshooting

No sound? Wrong sound? When a problem like this occurs, please check the following points before assuming that the product is faulty. Many problems can be solved by executing the Factory Reset operation (page 23). If the problem persists, consult your Yamaha dealer.

Issue	Suspected cause	Solution
The instrument turns off unexpectedly.	This is normal when the Auto Power Off function is enabled.	If necessary, you can deactivate the Auto Power Off function to prevent it from turning off the instrument again (page 23).
No sound is produced.	Related external equipment (e.g., amplifier, speaker, headphones) is not properly connected to this instrument via audio cables.	Since this instrument has no built-in speakers, you will need an external audio system or a set of stereo headphones to properly monitor it (page 22).
	Power to this instrument or the connected external audio equipment are not turned on.	Check the power to this instrument and the connected external audio equipment are turned on.
	The volume of this instrument and the connected external audio equipment are turned fully down.	Adjust the volume. Use the [MASTER VOLUME] knob to adjust the volume. If a foot controller has been connected to the FOOT CONTROLLER [1]/[2] jacks, try using it to increase the volume.
	All the Voice Section [ON/OFF] switches are set to OFF.	Set the desired Voice Section [ON/OFF] switch(es) to ON.
	The volume of the Voice Sections are turned fully down.	Use the [VOLUME] knobs of each Voice Section to adjust the volume.
	Local Control is set to "Off."	When Local Control is set to "Off," the internal tone generator will not sound even if you play the keyboard. Set Local Control to "On" (page 38).
	MIDI volume or expression has been set to a very low level by an external MIDI controller.	Select other Live Set Sound. If a foot controller has been connected to the FOOT CONTROLLER [1]/[2] jacks, try using it to increase the volume.
A sound continues to play indefinitely.	Effect sounds such as delay continue.	Lower the [DEPTH] knob value, or set the EFFECT1/2 [ON/OFF] button or the Section [ON/OFF] switch to OFF. If another Live Set Sound is selected during a sound continues to play, press the currently selected Live Set Sound button once more.
Sounds are distorted.	Effect settings are not appropriate.	Sound will be distorted depending on the effect types and the settings. Change the effect types and the settings.
	Volume is set too high.	Adjust the volume. To adjust the overall volume, adjust the "I/O Volume" → "Output" (page 38).
	Volume of this instrument and the connected external audio source are set too high.	Adjust the volume of the connected external audio device, or use the INPUT [GAIN] knob of this instrument. You can also adjust the volume from the "I/O Volume" → "USB Audio" (page 38).
Sound output is intermittent and stuttered.	The entire sound has exceeded the maximum polyphony (128 notes).	Be careful not to exceed the maximum polyphony.
No effect is applied.	The depth is turned to the minimum level.	Use the [DEPTH] knob to adjust the effect depth.

Issue	Suspected cause	Solution
Data communication between the computer and this instrument does not work properly.	The Port settings on the computer are not appropriate.	Check the port settings on the computer.
MIDI bulk data transmission does not work properly.	Use of the wrong terminals (MIDI, USB).	Check the connections.
	Wrong MIDI device number.	Check the MIDI device number.
Cannot save data to the external USB flash drive.	The USB flash drive is write protected.	Unlock the write protect.
	The USB flash drive is not formatted properly.	Format again.
A pedal has no effect.	The pedal is not correctly connected.	Make sure that the pedal's plug is fully and firmly inserted.
Nothing is displayed on the LCD, even the instrument's power is on.	"Display Lights" → "LCD SW" is set to "Off".	Set the "LCD SW" to "On" (page 39).
	"Display Lights" → "LCD Contrast" value is set too low.	Adjust the contrast from "LCD Contrast" (page 39).

Specifications

Item		Details
		YC61
Keyboard		61 keys, semi-weighted waterfall keyboard (initial touch)
Tone Generation	Tone Generation Technology	VCM Organ, AWM2, FM
	Polyphony (max.)	VCM Organ + AWM2: 128*, FM: 128 *Total of VCM Organ and AWM2
Voices	Number of Live Set Sounds	160 (Preset Live Set Sounds: 80)
	Number of Voices	145 (Organ: 6 / Keys: 139)
	Effects	Insertion Effect: Organ 1 system (pre drive) Key A 2 systems (1: 32 types, 2: 32 types) Key B 2 systems (1: 32 types, 2: 32 types) Effect: 32 types Speaker/Amp: 6 types (Rotary Speaker: 2 types, Amp: 4 types) Reverb Master Equalizer: 3-band (with sweepable mid)
Display	Type	Full Dot LCD (128 x 64 dots)
Connectors		OUTPUT [L/MONO]/[R] (6.3 mm, standard phone jacks, unbalanced) [PHONES] (6.3 mm, standard stereo phone jack) INPUT [L/MONO]/[R] (6.3 mm, standard phone jacks) FOOT CONTROLLER [1]/[2] FOOT SWITCH [SUSTAIN]/[ASSIGNABLE] MIDI [IN]/[OUT] USB [TO HOST]/[TO DEVICE] [AC IN]
Size/Weight	Dimensions (W x D x H)	896 mm x 309 mm x 108 mm (35-1/4" x 12-3/16" x 4-1/4")
	Weight	7.1 kg (15 lb, 10 oz)
Included Accessories		Owner's Manual (this book) x 1 Power cord x 1

The contents of this manual apply to the latest specifications as of the printing date.

Since Yamaha makes continuous improvements to the product, this manual may not completely apply to the specifications of your particular product. To obtain the latest manual, access the Yamaha website then download the manual file.

Index

A

Auto Power Off23

C

Computer 27, 29

E

Effect17

EFFECT Section17

EG 16, 34

External Keyboard 27, 45

External MIDI keyboard27

F

Factory Reset23

File type25

Filter 16, 35

I

iPad 27, 29

iPhone 27, 29

K

Key A Section16

Key B Section16

L

Live Set12

Live Set Sound 12, 23

Live Set View12

Load25

LOWER15

M

Master EQ19

Master Keyboard47

MENU36

MIDI channel30

MIDI Port28

MIDI receive channel28

MIDI transmit channel28

O

Organ Section14

P

PERCUSSION15

PRE DRIVE15

R

REVERB Section19

Rotary Speaker 18, 44

S

Save25

Section10

SETTINGS42

SPEAKER/AMP Section18

Split 13, 23

Split (Key A, Key B)16

Split (Organ)15

Split Point13

SSS (Seamless Sound Switching)12

U

UPPER15

USB Audio29

USB flash drive25

USB [TO DEVICE]26

USB [TO HOST]26

V

VCM Organ14

VIBRATO/CHORUS15

Voice Section23

Y

Yamaha Steinberg USB Driver29

DATA LIST

Live Set Sound List

Bank	No	Name	Split Point	Section	Voice Name	MSB	LSB	PC
1	1	Jazz Lead	G2	Organ	H1	63	0	1
				Key A	-			
				Key B	-			
1	2	Rock Organ 1	G2	Organ	H2	63	0	2
				Key A	-			
				Key B	-			
1	3	Gospel Shout!	G2	Organ	H1	63	0	3
				Key A	-			
				Key B	-			
1	4	Rex Direct	G2	Organ	F2	63	0	4
				Key A	-			
				Key B	-			
1	5	Soulful Rd	G2	Organ	-	63	0	5
				Key A	78Rd			
				Key B	-			
1	6	Natural CFX	G2	Organ	-	63	0	6
				Key A	CFX			
				Key B	-			
1	7	FM EP 1	G2	Organ	-	63	0	7
				Key A	FM Piano DA			
				Key B	-			
1	8	FM Lead	G2	Organ	-	63	0	8
				Key A	FM Syn Lead 2			
				Key B	-			
2	1	Jazz Swish	G2	Organ	H1	63	1	1
				Key A	-			
				Key B	-			
2	2	Prog 1	G2	Organ	H2	63	1	2
				Key A	-			
				Key B	-			
2	3	Gospel Worship	G2	Organ	H1	63	1	3
				Key A	-			
				Key B	-			
2	4	Italian Organ 1	G2	Organ	F3	63	1	4
				Key A	-			
				Key B	-			
2	5	67 Trem EP	G2	Organ	-	63	1	5
				Key A	67Rd Dark			
				Key B	-			
2	6	One Ear Upright	G2	Organ	-	63	1	6
				Key A	U1			
				Key B	-			
2	7	80s Piano Layer	G2	Organ	-	63	1	7
				Key A	CFX			
				Key B	FM The EP			
2	8	Fat OB Brass	G2	Organ	-	63	1	8
				Key A	OB Brass 1			
				Key B	OB Brass 2			
3	1	Squabble	G2	Organ	H1	63	2	1
				Key A	-			
				Key B	-			
3	2	Casino Fire	G2	Organ	H2	63	2	2
				Key A	-			
				Key B	-			
3	3	H Split Ld/Ba	G2	Organ	H1	63	2	3
				Key A	-			
				Key B	-			
3	4	Church	G2	Organ	F1	63	2	4
				Key A	-			
				Key B	-			
3	5	Wr Trem	G2	Organ	-	63	2	5
				Key A	Wr Bright			
				Key B	-			
3	6	C7 w/Pad	G2	Organ	-	63	2	6
				Key A	C7			
				Key B	Analog Pad			

Bank	No	Name	Split Point	Section	Voice Name	MSB	LSB	PC
3	7	FM EP+Pad 1	G2	Organ	-	63	2	7
				Key A	FM The EP			
				Key B	Lite Strings			
3	8	Motion Pad	G2	Organ	-	63	2	8
				Key A	Mystic Pad			
				Key B	Analog Pad			
4	1	Clean Amp	G2	Organ	H3	63	3	1
				Key A	-			
				Key B	-			
4	2	H Split Ld/Chd	C3	Organ	H1	63	3	2
				Key A	-			
				Key B	-			
4	3	F1 Jazz	G2	Organ	F1	63	3	3
				Key A	-			
				Key B	-			
4	4	Rex Rotary	G2	Organ	F2	63	3	4
				Key A	-			
				Key B	-			
4	5	Rex Amp	G2	Organ	F2	63	3	5
				Key A	-			
				Key B	-			
4	6	Italian Organ 2	G2	Organ	F3	63	3	6
				Key A	-			
				Key B	-			
4	7	Italian Organ 3	G2	Organ	F3	63	3	7
				Key A	-			
				Key B	-			
4	8	F2 / RdBa	G2	Organ	F2	63	3	8
				Key A	78Rd			
				Key B	-			
5	1	CFX Bright	G2	Organ	-	63	4	1
				Key A	CFX			
				Key B	-			
5	2	C7	G2	Organ	-	63	4	2
				Key A	C7			
				Key B	-			
5	3	70's C7	G2	Organ	-	63	4	3
				Key A	C7			
				Key B	-			
5	4	Showbiz Upright	G2	Organ	-	63	4	4
				Key A	U1			
				Key B	-			
5	5	AP+Strings	G2	Organ	-	63	4	5
				Key A	CFX			
				Key B	Fast Strings			
5	6	Bass Stays Home	G2	Organ	-	63	4	6
				Key A	Upright Bass			
				Key B	C7			
5	7	78Rd Chorus	G2	Organ	-	63	4	7
				Key A	78Rd			
				Key B	-			
5	8	67Rd Overdrive	G2	Organ	-	63	4	8
				Key A	67Rd Bright			
				Key B	-			
6	1	Wr Dist	G2	Organ	-	63	5	1
				Key A	Wr Warm			
				Key B	-			
6	2	FM EP 2	G2	Organ	-	63	5	2
				Key A	FM The EP			
				Key B	-			
6	3	FM EP 3	G2	Organ	-	63	5	3
				Key A	FM Pf's Heart			
				Key B	-			
6	4	FM EP 4	G2	Organ	-	63	5	4
				Key A	FM Urban EP			
				Key B	FM DX EP			

Bank	No	Name	Split Point	Section	Voice Name	MSB	LSB	PC
6	5	FM EP 5	G2	Organ	-	63	5	5
				Key A	FM The EP			
				Key B	FM DX Road			
6	6	Magic Piano	G2	Organ	-	63	5	6
				Key A	67Rd Dark			
				Key B	FM Pf's Heart			
6	7	80s Soundtrack	G2	Organ	-	63	5	7
				Key A	78Rd			
				Key B	Analog Pad			
6	8	FM EP+Pad 2	G2	Organ	-	63	5	8
				Key A	FM Pf's Heart			
				Key B	Analog Pad			
7	1	Swell Backgrnd	C3	Organ	-	63	6	1
				Key A	FM Saw Pad			
				Key B	67Rd Dark			
7	2	Bass and 73Rd	G2	Organ	-	63	6	2
				Key A	Finger Bass			
				Key B	73Rd			
7	3	Analog Pad	G2	Organ	-	63	6	3
				Key A	Analog Pad			
				Key B	Noble Pad			
7	4	Fat Pad	G2	Organ	-	63	6	4
				Key A	JP Strings			
				Key B	Analog Pad			
7	5	Massive FM	G2	Organ	-	63	6	5
				Key A	FM Saw Pad			
				Key B	FM BellSquare			
7	6	Smooth Strings	G2	Organ	-	63	6	6
				Key A	FM Syn Str			
				Key B	JP Strings			
7	7	Stringy Octaves	G2	Organ	-	63	6	7
				Key A	Oct Syn Str			
				Key B	Unison Str			
7	8	Synth Brass	G2	Organ	-	63	6	8
				Key A	Synth Brass 1			
				Key B	Synth Brass 4			
8	1	Analog Lead	G2	Organ	-	63	7	1
				Key A	Classic Mini			
				Key B	-			
8	2	Expressive Lead	G2	Organ	-	63	7	2
				Key A	Sine Lead			
				Key B	Classic Mini			
8	3	Monster Lead	G2	Organ	-	63	7	3
				Key A	FM Syn Lead 1			
				Key B	FM Syn Lead 2			
8	4	Ep/Lead Split 1	G2	Organ	-	63	7	4
				Key A	73Rd			
				Key B	Soft Square			
8	5	Ep/Lead Split 2	G2	Organ	-	63	7	5
				Key A	FM DX EP			
				Key B	Mini Lead			
8	6	Pad/Lead	G2	Organ	-	63	7	6
				Key A	Analog Pad			
				Key B	Funky Mini			
8	7	Icy Split	C3	Organ	-	63	7	7
				Key A	Digi Pad			
				Key B	Mini Lead			
8	8	Sticky Bass	G2	Organ	-	63	7	8
				Key A	1o1 Bass			
				Key B	Analog Bass			
9	1	Aggressive Bass	G2	Organ	-	63	8	1
				Key A	1o1 Bass			
				Key B	Analog Bass			
9	2	Dual Bass	G2	Organ	-	63	8	2
				Key A	FM Saw Pad			
				Key B	Unison Bass			
9	3	FM Harmonic Ba	G2	Organ	-	63	8	3
				Key A	Mini Sub Bass			
				Key B	FM Tear Bass			
9	4	Syn Bell 1	G2	Organ	-	63	8	4
				Key A	Heaven Bell			
				Key B	-			
9	5	Syn Bell 2	G2	Organ	-	63	8	5
				Key A	Far Away FM			
				Key B	-			
9	6	Concerto Goldo	G2	Organ	-	63	8	6
				Key A	Slow Strings			
				Key B	Violin			

Bank	No	Name	Split Point	Section	Voice Name	MSB	LSB	PC
9	7	String Ensemble	G2	Organ	-	63	8	7
				Key A	Fast Strings			
				Key B	Violin			
9	8	Big Fanfare	G2	Organ	-	63	8	8
				Key A	Marcato Str			
				Key B	Brass 3			
10	1	Classic Gt.	G2	Organ	-	63	9	1
				Key A	Classic Gt			
				Key B	-			
10	2	Steel Gt.	G2	Organ	-	63	9	2
				Key A	Steel Gt			
				Key B	-			
10	3	Clean Gt.	G2	Organ	-	63	9	3
				Key A	Clean Gt 1			
				Key B	-			
10	4	Brass Section	G2	Organ	-	63	9	4
				Key A	Brass 1			
				Key B	-			
10	5	Brass w/Sax	G2	Organ	-	63	9	5
				Key A	Brass 1			
				Key B	Brass 2			
10	6	Upright Bass	G2	Organ	-	63	9	6
				Key A	Upright Bass			
				Key B	-			
10	7	Fingered Bass	G2	Organ	-	63	9	7
				Key A	Finger Bass			
				Key B	-			
10	8	Slap Bass	G2	Organ	-	63	9	8
				Key A	Slap Bass			
				Key B	-			

Voice List

Section	Category	Sub Category	No.	Name	Parameter Value(*)	
Organ	-	-	-	H1	0	
			-	H2	1	
			-	H3	2	
			-	F1	3	
			-	F2	4	
Keys A/B	Piano	Grand	01	CFX	6	
			02	S700	7	
			03	C7	8	
		Upright	04	U1	9	
			05	CP80 1	10	
		CP	06	CP80 2	11	
			Layer	07	Piano Strings	12
		08		Piano Synth	13	
	E.Piano	Rd	01	78Rd	14	
			02	75Rd Funky	15	
			03	73Rd	16	
			04	67Rd Dark	17	
			05	67Rd Bright	18	
			Wr	06	Wr Warm	19
				07	Wr Bright	20
				08	Wr Wide	21
		Clavi		09	Clavi B	22
			10	Clavi S	23	
			11	Harpichord	24	
		FM	12	FM Piano DA	25	
			13	FM DX Road	26	
			14	FM The EP	27	
			15	FM DX EP	28	
			16	FM Pf's Heart	29	
			17	FM Urban EP	30	
			18	FM PowerClavi	31	
	Synth	Pad	01	FM Saw Pad	32	
			02	Analog Pad	33	
			03	Dark Light	34	
			04	Digi Pad	35	
			05	Noble Pad	36	
			06	Pop Pad	37	
			07	Fat Saw	38	
			08	Angel Pad	39	
			09	FM BellSquare	40	
10			FM Cloud Pad	41		
11			FM Bow RM Pad	42		
12			Itopia	43		
13			Mystic Pad	44		
14			Nowhere	45		
15			FM Choir	46		
16			Lite Strings	47		
Strings		17	JP Strings	48		
		18	FM Syn Str	49		
		19	Pop Syn Str	50		
		20	Unison Str	51		
		21	Oct Syn Str	52		
Brass		22	Synth Brass 1	53		
		23	Synth Brass 2	54		
		24	Synth Brass 3	55		
		25	Synth Brass 4	56		
	26	OB Brass 1	57			
	27	OB Brass 2	58			
	28	OB Brass 3	59			
	29	FM Brass	60			
	30	FM Brass Ens	61			
Lead	31	FM Syn Lead 1	62			
	32	FM Syn Lead 2	63			
	33	Classic Mini	64			
	34	Mini Lead	65			
			35	Funky Mini	66	

Section	Category	Sub Category	No.	Name	Parameter Value(*)	
Keys A/B	Synth	Lead	36	Sine Lead	67	
			37	Square Lead	68	
			38	Soft Square	69	
			39	Dirty Hook	70	
			40	Sync Saw Lead	71	
			41	Nu Mini	72	
			42	5th Lead	73	
			43	Calliope Lead	74	
			Bass	44	Mini Sub Bass	75
				45	Analog Bass	76
				46	1o1 Bass	77
				47	Synth Bass	78
				48	FM Tear Bass	79
				49	FM DX E.Bass	80
		50		FM BoogieBass	81	
		51		FM SuperBass	82	
		52		Unison Bass	83	
		53		FM Owl Bass	84	
		ChromPerc		54	FM Glocken	85
				55	FM Far Away	86
				56	Digi Bell	87
				57	FM Brite Comp	88
				58	Heaven Bell	89
			59	FM Tblr Bells	90	
		Others	Strings	01	Slow Strings	91
				02	Marcato Str	92
				03	Fast Strings	93
				04	Tremolo Str	94
				05	Pizzicato	95
				06	Tape Strings	96
				07	Violin	97
				08	Cello	98
			Guitar	09	Classic Gt	99
				10	Steel Gt	100
				11	12Strings Gt	101
				12	FM Jazz Gt	102
				13	Clean Gt 1	103
				14	Clean Gt 2	104
				15	Clean Gt 3	105
				16	Banjo	106
				17	Sitar	107
				18	Shamisen	108
				19	Koto	109
Brass	20		Brass 1	110		
	21		Brass 2	111		
	22		Brass 3	112		
	23		St. Brass	113		
	24		Trumpet	114		
	25		Trombone	115		
	26		Horn 1	116		
	27		Horn 2	117		
	Sax / Winds		28	Sax Section 1	118	
29			Sax Section 2	119		
30			Soprano Sax	120		
31			Alto Sax	121		
32			Tenor Sax	122		
33			Baritone Sax	123		
34			Jazz Flute	124		
35			Alto Flute	125		
36			Tape Flute	126		
37			Harmonica	127		
Bass	38		FM Harmonica	128		
	39	Pan Flute	129			
	40	Bag Pipe	130			
	41	Shakuhachi	131			
	42	Upright Bass	132			
	43	Finger Bass	133			

Section	Category	Sub Category	No.	Name	Parameter Value(*)
Keys A/B	Others	Bass	44	Pick Bass	134
			45	Fretless Bass	135
			46	Slap Bass	136
		ChromPerc	47	Glocken	137
			48	Jazz Vibes	138
			49	Marimba	139
			50	Xylophone	140
			51	Tubular Bell	141
		Others	52	Kalimba	142
			53	Accordion	143
			54	Musette	144

*This is the number used for the "Voice Number" parameters (pages 67, 68).

Control Change Number List

O: = Organ, U: = Organ UPPER, L: = Organ LOWER, A: = Key A, B: = Key B, E: = EFFECT, S: = SPEAKER/AMP

*1: Parameter Value/Controller Value Correspondence Table (page 61)

*2: Assignable only to the foot switch.

*3: Assignable only to the foot controller 1/2 and modulation lever.

Parameters shown within parentheses do not affect the sound of this instrument.

	CC No. (LCD indication)	Panel controls	Table (*1)
Organ	13 O: Volume	[VOLUME] knob	A
	14 O: Pre Drive	[PRE DRIVE] knob	A
	102 U: Drawbar 16'	Drawbar	A
	103 U: Drawbar 5 1/3'	Drawbar	A
	104 U: Drawbar 8'	Drawbar	A
	105 U: Drawbar 4'	Drawbar	A
	106 U: Drawbar 2 2/3'	Drawbar	A
	107 U: Drawbar 2'	Drawbar	A
	108 U: Drawbar 1 3/5'	Drawbar	A
	109 U: Drawbar 1 1/5'	Drawbar	A
	110 U: Drawbar 1'	Drawbar	A
	111 L: Drawbar 16'	Drawbar	A
	112 L: Drawbar 5 1/3'	Drawbar	A
	113 L: Drawbar 8'	Drawbar	A
	114 L: Drawbar 4'	Drawbar	A
	115 L: Drawbar 2 2/3'	Drawbar	A
	116 L: Drawbar 2'	Drawbar	A
	117 L: Drawbar 1 3/5'	Drawbar	A
	118 L: Drawbar 1 1/5'	Drawbar	A
119 L: Drawbar 1'	Drawbar	A	
Key A	18 A: Volume	[VOLUME] knob	A
	19 A: Tone	[TONE] knob	A
	20 A: EG	[EG FILTER] knob	A
	21 A: Filter	[EG FILTER] knob	A
	22 A: Effect 1 Depth	[DEPTH] knob	A
	23 A: Effect 1 Rate	[RATE] knob	A
	24 A: Effect 2 Depth	[DEPTH] knob	A
25 A: Effect 2 Rate	[RATE] knob	A	
Key B	27 B: Volume	[VOLUME] knob	A
	28 B: Tone	[TONE] knob	A
	29 B: EG	[EG FILTER] knob	A
	30 B: Filter	[EG FILTER] knob	A
	31 B: Effect 1 Depth	[DEPTH] knob	A
	68 B: Effect 1 Rate	[RATE] knob	A
	69 B: Effect 2 Depth	[DEPTH] knob	A
70 B: Effect 2 Rate	[RATE] knob	A	
EFFECT	94 E: Depth	[DEPTH] knob	A
	79 E: Rate	[RATE] knob	A
SPEAKER/AMP	93 S: Drive	[DRIVE] knob	A
	80 S: Tone	[TONE] knob	A
	85 Rotary Slow/Fast	[STOP] button [Slow Fast] button	D
REVERB	91 All Reverb Depth	[DEPTH] knob	A
	81 O: Reverb Depth	[DEPTH] knob	A
	82 A: Reverb Depth	[DEPTH] knob	A
	83 B: Reverb Depth	[DEPTH] knob	A
MASTER EQUALIZER	87 Master EQ High	[HIGH] knob	B
	88 Master EQ Mid	[MID] knob	B
	89 Master EQ Freq	[FREQUENCY] knob	C
	90 Master EQ Low	[LOW] knob	B

	CC No. (LCD indication)	Panel controls	Table (*1)
Foot Switch, Foot Controller 1, Foot Controller 2, Modulation Lever	1 Modulation		
	4 Pedal Wah		
	5 (Portamento Time)		
	6 (Data Entry MSB)		
	7 All Volume		
	10 (Pan)		
	11 Expression		
	13 O: Volume	[VOLUME] knob	A
	14 O: Pre Drive	[PRE DRIVE] knob	A
	18 A: Volume	[VOLUME] knob	A
19 A: Tone	[TONE] knob	A	
20 A: EG	[EG FILTER] knob	A	
21 A: Filter	[EG FILTER] knob	A	
22 A: Effect 1 Depth	[DEPTH] knob	A	
23 A: Effect 1 Rate	[RATE] knob	A	
24 A: Effect 2 Depth	[DEPTH] knob	A	
25 A: Effect 2 Rate	[RATE] knob	A	
27 B: Volume	[VOLUME] knob	A	
28 B: Tone	[TONE] knob	A	
29 B: EG	[EG FILTER] knob	A	
30 B: Filter	[EG FILTER] knob	A	
31 B: Effect 1 Depth	[DEPTH] knob	A	
32 (Bank LSB)			
38 (Data Entry LSB)			
64 Sustain	(*2)		
65 (Portamento)			
66 Sostenuto	(*2)		
67 Soft			
68 B: Effect 1 Rate	[RATE] knob	A	
69 B: Effect 2 Depth	[DEPTH] knob	A	
70 B: Effect 2 Rate	[RATE] knob	A	
71 (Resonance)			
72 (Release)			
73 (Attack)			
74 (Cutoff)			
79 E: Rate	[RATE] knob	A	
80 S: Tone	[TONE] knob	A	
81 O: Reverb Depth	[DEPTH] knob	A	
82 A: Reverb Depth	[DEPTH] knob	A	
83 B: Reverb Depth	[DEPTH] knob	A	
84 (Portamento Ctrl)			
85 Rotary Slow/Fast	[STOP] button	D	
	[Slow Fast] button	D	
87 Master EQ High	[HIGH] knob	B	
88 Master EQ Mid	[MID] knob	B	
89 Master EQ Freq	[FREQUENCY] knob	C	
90 Master EQ Low	[LOW] knob	B	
91 All Reverb Depth	[DEPTH] knob	A	
92 (Effect 2 Depth)			
93 S: Drive	[DRIVE] knob	A	
94 E: Depth	[DEPTH] knob	A	
95 (Effect 5 Depth)			
96 (Data Increment)			
97 (Data Decrement)			
98 (NRPN LSB)			
99 (NRPN MSB)			
100 (RPN LSB)			
101 (RPN MSB)			
102 U: Drawbar 16'	Drawbar	A	
103 U: Drawbar 5 1/3'	Drawbar	A	
104 U: Drawbar 8'	Drawbar	A	
105 U: Drawbar 4'	Drawbar	A	

	CC No. (LCD indication)	Panel controls	Table (*1)
Foot Switch, Foot Controller 1, Foot Controller 2, Modulation Lever	106 U: Drawbar 2 2/3'	23 Drawbar	A
	107 U: Drawbar 2'	23 Drawbar	A
	108 U: Drawbar 1 3/5'	23 Drawbar	A
	109 U: Drawbar 1 1/3'	23 Drawbar	A
	110 U: Drawbar 1'	23 Drawbar	A
	111 L: Drawbar 16'	23 Drawbar	A
	112 L: Drawbar 5 1/3'	23 Drawbar	A
	113 L: Drawbar 8'	23 Drawbar	A
	114 L: Drawbar 4'	23 Drawbar	A
	115 L: Drawbar 2 2/3'	23 Drawbar	A
	116 L: Drawbar 2'	23 Drawbar	A
	117 L: Drawbar 1 3/5'	23 Drawbar	A
	118 L: Drawbar 1 1/3'	23 Drawbar	A
	119 L: Drawbar 1'	23 Drawbar	A
	--- Live Set Sound +	(*2)	
	--- Live Set Sound -	(*2)	
	--- USB Audio Volume	(*3)	

Parameter Value/Controller Value Correspondence Table

A

Parameter	Controller	
	Transmitted	Recognized
0-127	0-127	0-127

B

Parameter	Controller		
		Transmitted	Recognized
-12dB	52	0-5	0-5
-11dB	53	6-10	6-10
-10dB	54	11-15	11-15
-9dB	55	16-20	16-20
-8dB	56	21-25	21-25
-7dB	57	26-30	26-30
-6dB	58	31-35	31-35
-5dB	59	36-40	36-40
-4dB	60	41-46	41-46
-3dB	61	47-51	47-51
-2dB	62	52-56	52-56
-1dB	63	57-61	57-61
0dB	64	62-66	62-66
1dB	65	67-71	67-71
2dB	66	72-76	72-76
3dB	67	77-81	77-81
4dB	68	82-87	82-87
5dB	69	88-92	88-92
6dB	70	93-97	93-97
7dB	71	98-102	98-102
8dB	72	103-107	103-107
9dB	73	108-112	108-112
10dB	74	113-117	113-117
11dB	75	118-122	118-122
12dB	76	123-127	123-127

C

Parameter		Controller	
		Transmitted	Recognized
100Hz	14	0-3	0-3
110Hz	15	4-6	4-6
125Hz	16	7-9	7-9
140Hz	17	10-12	10-12
160Hz	18	13-15	13-15
180Hz	19	16-18	16-18
200Hz	20	19-21	19-21
225Hz	21	22-24	22-24
250Hz	22	25-28	25-28
280Hz	23	29-31	29-31
315Hz	24	32-34	32-34
355Hz	25	35-37	35-37
400Hz	26	38-40	38-40
450Hz	27	41-43	41-43
500Hz	28	44-46	44-46
560Hz	29	47-49	47-49
630Hz	30	50-53	50-53
700Hz	31	54-56	54-56
800Hz	32	57-59	57-59
900Hz	33	60-62	60-62
1.0kHz	34	63-65	63-65
1.1kHz	35	66-68	66-68
1.2kHz	36	69-71	69-71
1.4kHz	37	72-74	72-74
1.6kHz	38	75-78	75-78
1.8kHz	39	79-81	79-81
2.0kHz	40	82-84	82-84
2.2kHz	41	85-87	85-87
2.5kHz	42	88-90	88-90
2.8kHz	43	91-93	91-93
3.2kHz	44	94-96	94-96
3.6kHz	45	97-99	97-99
4.0kHz	46	100-102	100-102
4.5kHz	47	103-106	103-106
5.0kHz	48	107-109	107-109
5.6kHz	49	110-112	110-112
6.3kHz	50	113-115	113-115
7.0kHz	51	116-118	116-118
8.0kHz	52	119-121	119-121
9.0kHz	53	122-124	122-124
10kHz	54	125-127	125-127

D

Parameter	Controller	
	Transmitted	Recognized
Slow	0	0-63
Stop	64	64
Fast	127	65-127

MIDI Data Format

(1) TRANSMIT FLOW

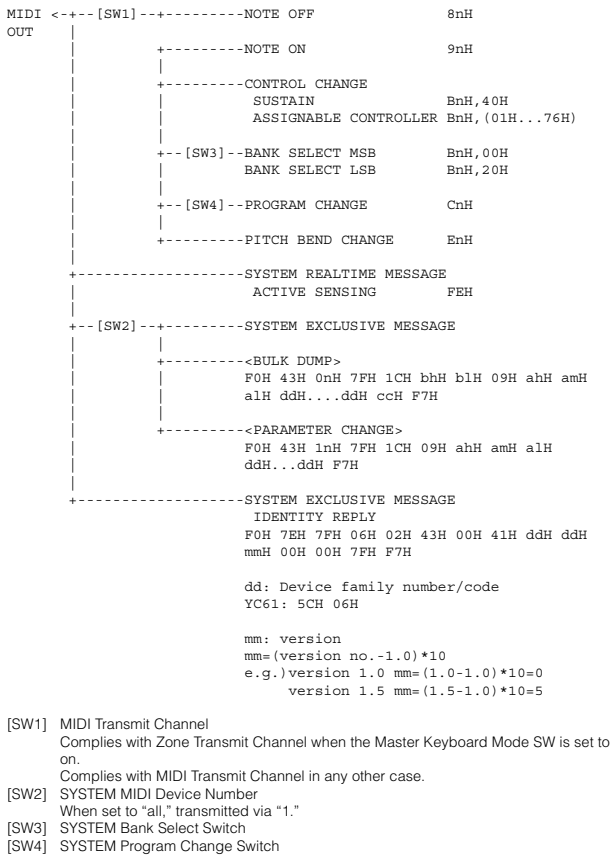

(2) RECEIVE FLOW

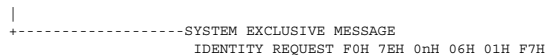
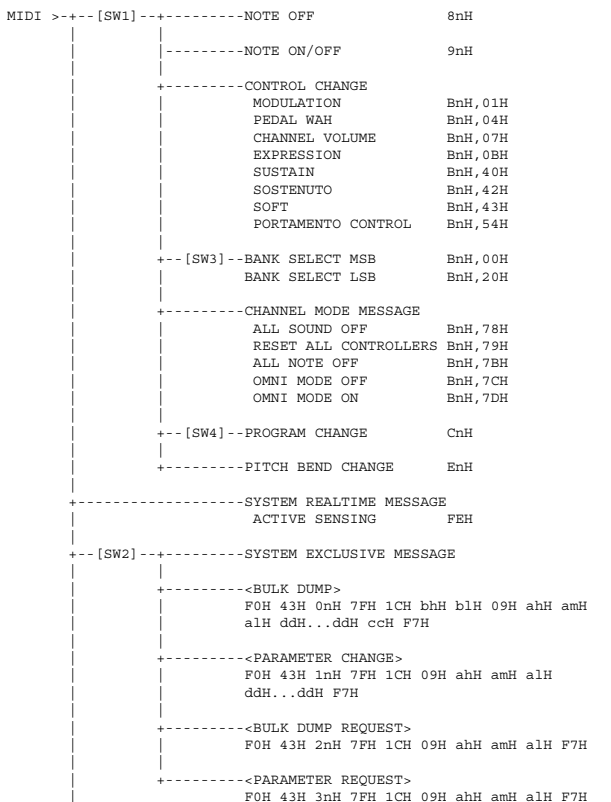

- [SW1] Complies with MIDI Receive Channel.
- [SW2] SYSTEM MIDI Device Number
- [SW3] SYSTEM Bank Select Switch
- [SW4] SYSTEM Program Change Switch

(3) TRANSMIT/RECEIVE DATA

(3-1) CHANNEL VOICE MESSAGES

(3-1-1) NOTE OFF

```

STATUS      1000nnnn (9nH)      n=0-15 CHANNEL NUMBER
NOTE No.    0kkkkkkk           k=0(C-2)-127(G8)
VELOCITY    0vvvvvvv           v=64 Transmit
    
```

(3-1-2) NOTE ON/OFF

```

STATUS      1000nnnn (8nH)      n=0-15 CHANNEL NUMBER
NOTE No.    0kkkkkkk           k=0(C-2)-127(G8)
VELOCITY NOTE ON 0vvvvvvv (v≠0)
NOTE OFF    0vvvvvvv (v=0)
    
```

(3-1-3) CONTROL CHANGE

```

STATUS      1011nnnn (BnH)      n=0-15 CHANNEL NUMBER
CONTROL NUMBER 0ccccccc
CONTROL VALUE  0vvvvvvv
    
```

*TRANSMITTED CONTROL NUMBER

c=0	BANK SELECT MSB	;v=0-127	*1
c=32	BANK SELECT LSB	;v=0-127	*1
c=64	SUSTAIN	;v=0-127	*3
c=1...119	ASSIGNABLE CONTROLLER	;v=0-127	*2

*RECEIVED CONTROL NUMBER

c=0	BANK SELECT MSB	;v=0-127	*1
c=32	BANK SELECT LSB	;v=0-127	*1
c=1	MODULATION	;v=0-127	
c=4	PEDAL WAH	;v=0-127	
c=7	CHANNEL VOLUME	;v=0-127	
c=11	EXPRESSION	;v=0-127	
c=64	SUSTAIN	;v=0-127	
c=66	SOSTENUTO	;v=0-63:OFF, 64-127:ON	
c=67	SOFT	;v=0-127	
c=84	PORTAMENTO CONTROL	;v=0-127	

*1 Relation between BANK SELECT and PROGRAM is as follows:

	CATEGORY	MSB	LSB	PROGRAM No.
Live Set Page 1	:	63	0	0..7
:	:	:	:	:
Live Set Page 20	:	63	19	0..7

*2 The default CONTROL NUMBERS of ASSIGNABLE CONTROLLER are as follows:

MODULATION	1
FOOT CONTROLLER 1	11
FOOT CONTROLLER 2	4
FOOT SWITCH Live Set Inc	

*3 When Sustain is set to something other than "FC3A (HalfOn)," operating the foot switch transmits only values of 0 (off) or 127 (on).

Bank Select will be actually executed when a Program Change message is received. Bank Select and Program Change numbers that are not supported by this instrument will be ignored.

(3-1-4) PROGRAM CHANGE

```

STATUS      1100nnnn (CnH)      n=0-15 CHANNEL NUMBER
PROGRAM NUMBER 00000ppp         p=0-7
    
```

(3-1-5) PITCH BEND CHANGE

```

STATUS      1110nnnn (EnH)      n=0-15 CHANNEL NUMBER
LSB         0vvvvvvv           PITCH BEND CHANGE LSB
MSB         0vvvvvvv           PITCH BEND CHANGE MSB
Transmitted with a resolution of 7 bits.
    
```

(3-2) CHANNEL MODE MESSAGES

```

STATUS      1011nnnn (BnH)      n=0-15 CHANNEL NUMBER
CONTROL NUMBER 0ccccccc
CONTROL VALUE  0vvvvvvv           v=DATA VALUE
    
```

(3-2-1) ALL SOUND OFF (CONTROL NUMBER = 78H, DATA VALUE = 0)

All the sounds currently being played, including channel messages such as note-on of a certain channel, are muted this message is received.

(3-2-2) RESET ALL CONTROLLERS (CONTROL NUMBER = 79H, DATA VALUE = 0)

Resets the values set for the following controllers.

PITCH BEND CHANGE	0 (center)
MODULATION	0 (minimum)
PEDAL WAH	0 (minimum)
EXPRESSION	127 (maximum)
SUSTAIN	0 (off)
SOSTENUTO	0 (off)
SOFT	0 (off)
PORTAMENTO CONTROL	Clear the reserved note number

Doesn't reset the following data:
PROGRAM CHANGE, BANK SELECT MSB/LSB, VOLUME

(3-2-3) ALL NOTE OFF (CONTROL NUMBER = 7BH, DATA VALUE = 0)
All the notes currently set to on in certain channel(s) are muted when receiving this message. However, if Sustain or Sostenuto is on, notes will continue sounding until these are turned off.

(3-2-4) OMNI MODE OFF (CONTROL NUMBER = 7CH, DATA VALUE = 0)
Performs the same function as when receiving ALL NOTES OFF.

(3-2-5) OMNI MODE ON (CONTROL NUMBER = 7DH, DATA VALUE = 0)
Performs the same function as when receiving ALL NOTES OFF.

(3-3) SYSTEM REAL TIME MESSAGES

(3-3-1) ACTIVE SENSING
STATUS 11111110 (FEH)

Transmitted every 200 msec.
Once this code is received, the instrument starts sensing. When neither status messages nor data are received for more than approximately 350 ms, the MIDI receive buffer will be cleared, and the sounds currently being played are forcibly turned off.

(3-4) SYSTEM EXCLUSIVE MESSAGE

(3-4-1) UNIVERSAL NON REALTIME MESSAGE

(3-4-1-1) IDENTITY REQUEST (Receive only)
F0H 7EH 0nH 06H 01H F7H ("n" = Device No. However, this instrument receives under "omni.")

(3-4-1-2) IDENTITY REPLY (Transmit only)
F0H 7EH 7FH 06H 02H 43H 00H 41H ddH ddH mmH 00H 00H 7FH F7H

dd: Device family number/code
YC61: 5CH 06H

mm: version
mm=(version no.-1.0)*10
e.g.) version 1.0 mm=(1.0-1.0)*10=0
version 1.5 mm=(1.5-1.0)*10=5

(3-4-2) UNIVERSAL REALTIME MESSAGE

(3-4-3) PARAMETER CHANGE

(3-4-3-1) NATIVE PARAMETER CHANGE, MODE CHANGE

```

11110000 F0 Exclusive status
01000011 43 YAMAHA ID
0001nnnn 1n Device Number
01111111 7F Group ID High
00011100 1C Group ID Low
00001001 09 Model ID
0aaaaaaaa aaaaaaa Address High
0aaaaaaaa aaaaaaa Address Mid
0aaaaaaaa aaaaaaa Address Low
0ddddddd ddddddd Data
|
11110111 F7 End of Exclusive
    
```

For parameters with data size of 2 or more, the appropriate number of data bytes will be transmitted.
See the following MIDI Data Table for Address.

(3-4-4) BULK DUMP

```

11110000 F0 Exclusive status
01000011 43 YAMAHA ID
0000nnnn 0n Device Number
01111111 7F Group ID High
00011100 1C Group ID Low
00001001 09 Model ID
0aaaaaaaa aaaaaaa Address High
0aaaaaaaa aaaaaaa Address Mid
0aaaaaaaa aaaaaaa Address Low
0 0 Data
|
0ccccccc ccccccc Check-sum
11110111 F7 End of Exclusive
    
```

See the following MIDI Data Table for Address and Byte Count.
Checksum is the value that results in a value of 0 for the lower 7 bits when the Byte Count, Start Address, Data and Checksum itself are added.

(3-4-5) DUMP REQUEST

```

11110000 F0 Exclusive status
01000011 43 YAMAHA ID
0010nnnn 2n Device Number
01111111 7F Group ID High
00011100 1C Group ID Low
00001001 09 Model ID
0aaaaaaaa aaaaaaa Address High
0aaaaaaaa aaaaaaa Address Mid
0aaaaaaaa aaaaaaa Address Low
11110111 F7 End of Exclusive
    
```

See the following MIDI Data Table for Address.

(3-4-6) PARAMETER REQUEST

```

11110000 F0 Exclusive status
01000011 43 YAMAHA ID
0011nnnn 3n Device Number
01111111 7F Group ID High
00011100 1C Group ID Low
00001001 09 Model ID
0aaaaaaaa aaaaaaa Address High
0aaaaaaaa aaaaaaa Address Mid
0aaaaaaaa aaaaaaa Address Low
11110111 F7 End of Exclusive
    
```

See the following MIDI Data Table for Address.

(4) SYSTEM OVERVIEW (Keyboard and Tone Generator)

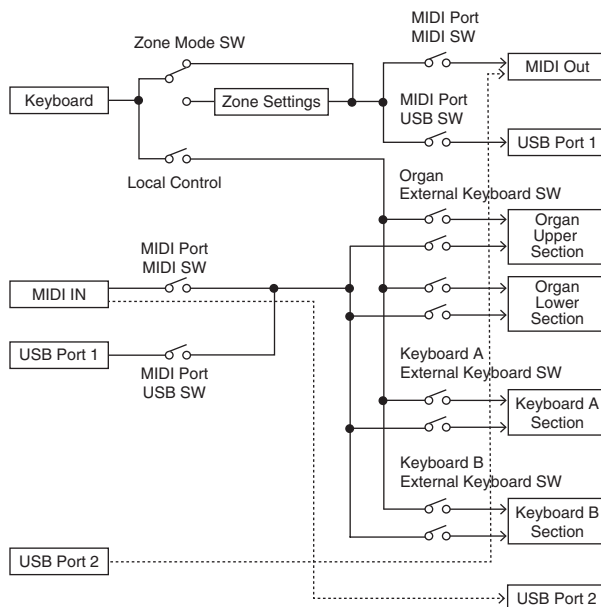

USB Port 2 is enabled when 'MIDI Port MIDI SW = OFF' and 'MIDI Port USB SW = ON'

ALL SOUND OFF clears all the sounds in the specific channel(s) played by both the keyboard and the data via MIDI.
ALL NOTES OFF received via MIDI clears the sounds in the specific channel(s) played via MIDI.

MIDI Data Table

Bank Select

MSB		LSB		Program No.	Type	Memory	Description
DEC	HEX	DEC	HEX				
63	3F	0	00	0-7	Live Set Sound	User	Live Set Page 1
		1	01	0-7		User	Live Set Page 2
		2	02	0-7		User	Live Set Page 3
		3	03	0-7		User	Live Set Page 4
		4	04	0-7		User	Live Set Page 5
		5	05	0-7		User	Live Set Page 6
		6	06	0-7		User	Live Set Page 7
		7	07	0-7		User	Live Set Page 8
		8	08	0-7		User	Live Set Page 9
		9	09	0-7		User	Live Set Page 10
		10	0A	0-7		User	Live Set Page 11
		11	0B	0-7		User	Live Set Page 12
		12	0C	0-7		User	Live Set Page 13
		13	0D	0-7		User	Live Set Page 14
		14	0E	0-7		User	Live Set Page 15
		15	0F	0-7		User	Live Set Page 16
		16	10	0-7		User	Live Set Page 17
		17	11	0-7		User	Live Set Page 18
		18	12	0-7		User	Live Set Page 19
19	13	0-7	User	Live Set Page 20			

Bulk Dump Block

"Top Address" indicates the top address of each block designated by the bulk dump operation. "Byte Count" indicates the data size contained in each block designated by the bulk dump operation. The block from the Bulk Header to the Bulk Footer of the Live Set Sound can be received regardless of their order; however, they cannot be received if an irrelevant Block is included. To execute 1 Live Set Sound bulk dump request, designate its corresponding Bulk Header address. For information about "mm" and "nn" shown in the following list, refer to the MIDI PARAMETER CHANGE TABLE (BULK CONTROL).

Group Number = 7F 1C, Model ID = 09

Parameter Block	Description	Byte Count		Top Address		
		DEC	HEX	High	Mid	Low
System	System	48	30	20	00	00
	Master EQ	20	14	20	40	00
Live Set Sound	Bulk Header	0	00	0E	pp	0n
	Soundmondo Format Version	4	04	00	7F	00
Common		1	01	46	00	00
	Zone 1	16	10	4A	00	00
	:				:	
	Zone 4				03	
Organ Section	Organ Section Common	36	24	50	00	00
	Organ Section Part Upper	20	14	50	10	
	Organ Section Part Lower	20	14	50	11	
Keys Sections	Key A Section	58	3A	60	00	00
	Key B Section	58	3A		01	
	Bulk Footer	0	00	0F	pp	0n

Parameter Base Address

Group Number = 7F 1C, Model ID = 09

Parameter Block	Top Address			Description
	High	Mid	Low	
	System	20	00	
	20	40	00	Master EQ
	00	7F	00	Soundmondo Format Version
BULK CONTROL	0E	00	00	Header
	0F	00	00	Footer
STORE TO FLASH	0D	00	00	Store To Flash
Live Set Sound	46	00	00	Common
Zone	4A	zz	00	Zone (zz: 00 - 03)
Organ Section	50	00	00	Common
	50	1p	00	Part (p: 0 - 1 (0: UPPER, 1: LOWER))
Keys Sections	60	0s	00	Section (s: 0 - 1 (0: A, 1: B))

Message Type	Data
Parameter Change	F0, 43, 1n, gh, gl, id, ah, am, al, dt, ... F7
Parameter Request	F0, 43, 3n, gh, gl, id, ah, am, al F7
Bulk Dump	F0, 43, 0n, gh, gl, bh, bl, id, ah, am, al, dt, ..., cc, F7
Bulk Request	F0, 43, 2n, gh, gl, id, ah, am, al, F7

- n: Device Number
- gh: Group Number High
- gl: Group Number Low
- bh: Byte Count High
- bl: Byte Count Low
- id: Model ID
- ah: Parameter Address High
- am: Parameter Address Middle
- al: Parameter Address Low
- dt: Data
- cc: Data Checksum

MIDI PARAMETER CHANGE TABLE (BULK CONTROL)

Group Number = 7F 1C, Model ID = 09

Address			Size	Data Range (HEX)	Parameter Name	Description	Default (HEX)	Notes
High	Mid	Low						
0E	pp	0n	1	-	Bulk Header	Live Set Sound User (pp = 0 - 19, n = 0 - 7)	-	
	7F	00	1	-		Current Sound Buffer	-	
0F	pp	0n	1	-	Bulk Footer	Live Set Sound User (pp = 0 - 19, n = 0 - 7)	-	
	7F	00	1	-		Current Sound Buffer	-	

SYSTEM

System Common

Group Number = 7F 1C, Model ID = 09

Address			Size	Data Range	Parameter Name	Description	Default (HEX)	Notes
High	Mid	Low						
20	00	00	1		reserved			
		01	1		reserved			
		02	4	00 - 00 00 - 07 00 - 0F 00 - 0F	Master Tune	414.72 - 466.78 [Hz] 1st bit3-0: bit15-12 2nd bit3-0: bit11-8 3rd bit3-0: bit 7-4 4th bit3-0: bit 3-0	00 04 00 00	
		06	1	3D - 43	Keyboard Octave Shift	-3 - 0 - +3	40	
		07	1	34 - 4C	Keyboard Transpose	-12 - +12 [semitones]	40	
		08	1	00 - 01	Controller Reset	Hold, Reset	01	
		09	1	00 - 01	Local Control	Off, On	01	
		0A	1	00 - 0F, 7F	Tx Channel	1 - 16, Off	00	
		0B	1	00 - 10	Rx Channel	1 - 16, All	00	
		0C	1	00 - 03	MIDI Control	Off, On, Invert	00	
		0D	1		reserved			
		0E	1	38 - 48	Output Gain	-24 - 0 - +24 [dB]	3E	
		0F	1		reserved			
		10	1	00 - 04	Keyboard Touch Curve	Normal, Soft, Hard, Wide, Fixed	00	
		11	1	01 - 7F	Keyboard Fixed Velocity	1 - 127	40	
		12	1	00 - 01	Transmit/Receive Bank Select	Off, On	01	
		13	1	00 - 01	Transmit/Receive Program Change	Off, On	01	
		14	1		reserved			
		15	1	00 - 01	MIDI In/Out	Off, On	01	
		16	1	00 - 01	USB In/Out	Off, On	01	
		17	1		reserved			
		18	1		reserved			
		19	1	00 - 01	Display Lights Section	Off, On	01	
		1A	1	00 - 01	Display Lights Ins Effect	Off, On	01	
		1B	1	00 - 01	Display Lights LCD	Off, On	01	
		1C	1		reserved			
		1D	1		reserved			
		1E	1	00 - 01	Value Indication	Off, On	01	
		1F	1	00 - 01	Drawbar Mode	Jump, Catch	00	
		20	1	00 - 01	SW Direction	Default, Reverse	00	
		21	1		reserved			
		22	1	00 - 3F	LCD Contrast	1 - 63	20	
		23	1	00 - 01	Panel Lock Live Set	Off, On	01	
		24	1	00 - 01	Panel Lock Organ/Keys	Off, On	01	
		25	1	00 - 01	Panel Lock Effect/Sp Amp/Reverb	Off, On	01	
		26	1	00 - 01	Panel Lock Master EQ	Off, On	01	

Address			Size	Data Range	Parameter Name	Description	Default (HEX)	Notes
High	Mid	Low						
		27	1		reserved			
		28	1	00 - 01	Section Hold	Disable, Enable	00	
		29	1	00 - 01	Live Set View Mode	Close, Keep	00	
		2A	1	00 - 13	Power On Page	1 - 20	00	
		2B	1	00 - 07	Power On Sound	1 - 8	00	
		2C	1	00 - 79	FS Control Number	Off, 1 - 119, 120 (Live Set +), 121 (Live Set -)	78	
		2D	1	00 - 01	EG/Filter Reset	Off, On	01	
		2E	1		reserved			
		2F	1	00 - 7F	USB Audio Volume	0 - 127	40	
		30	1	00 - 02	Sustain Pedal Select	FC3A (Half On), FC3A (Half Off), FC4A/5	00	

TOTAL SIZE = 49 31 (HEX)

System MEQ

Address			Size	Data Range	Parameter Name	Description	Default (HEX)	Notes
High	Mid	Low						
20	40	00	1	34 - 4C	High Gain	-12dB - +12dB	40	
		01	1		reserved			
		02	1		reserved			
		03	1		reserved			
		04	1		reserved			
		05	1		reserved			
		06	1		reserved			
		07	1		reserved			
		08	1	34 - 4C	Mid Gain	-12dB - +12dB	40	
		09	1	0E - 36	Mid Frequency	100Hz - 10kHz	1C	
		0A	1		reserved			
		0B	1		reserved			
		0C	1		reserved			
		0D	1		reserved			
		0E	1		reserved			
		0F	1		reserved			
		10	1	34 - 4C	Low Gain	-12dB - +12dB	40	
		11	1		reserved			
		12	1		reserved			
		13	1	00 - 01	EQ On/Off	Off, On	01	

TOTAL SIZE = 20 14 (HEX)

Soundmondo Format Version

Address			Size	Data Range	Parameter Name	Description	Default (HEX)	Notes
High	Mid	Low						
00	7F	00	1	00 - 7F	Soundmondo Format Version Major		01	
			1	00 - 7F	Soundmondo Format Version Minor		00	
			1	00 - 7F	Soundmondo Format Version Bugfix		00	
			1		reserved		00	

TOTAL SIZE = 4 4 (HEX)

LIVE SET SOUND

Common

Group Number = 7F 1C, Model ID = 09

Address			Size	Data Range	Parameter Name	Description	Default (HEX)	Notes		
High	Mid	Low					YC61			
		46	00	00	1	20 – 7F	Live Set Sound Name 1	32 – 127 (ASCII)	40	'l'
				01	1	20 – 7F	Live Set Sound Name 2	32 – 127 (ASCII)	6E	'n'
				02	1	20 – 7F	Live Set Sound Name 3	32 – 127 (ASCII)	69	'i'
				03	1	20 – 7F	Live Set Sound Name 4	32 – 127 (ASCII)	74	't'
				04	1	20 – 7F	Live Set Sound Name 5	32 – 127 (ASCII)	20	' '
				05	1	20 – 7F	Live Set Sound Name 6	32 – 127 (ASCII)	53	'S'
				06	1	20 – 7F	Live Set Sound Name 7	32 – 127 (ASCII)	6F	'o'
				07	1	20 – 7F	Live Set Sound Name 8	32 – 127 (ASCII)	75	'u'
				08	1	20 – 7F	Live Set Sound Name 9	32 – 127 (ASCII)	6E	'n'
				09	1	20 – 7F	Live Set Sound Name 10	32 – 127 (ASCII)	64	'd'
				0A	1	20 – 7F	Live Set Sound Name 11	32 – 127 (ASCII)	20	
				0B	1	20 – 7F	Live Set Sound Name 12	32 – 127 (ASCII)	20	
				0C	1	20 – 7F	Live Set Sound Name 13	32 – 127 (ASCII)	20	
				0D	1	20 – 7F	Live Set Sound Name 14	32 – 127 (ASCII)	20	
				0E	1	20 – 7F	Live Set Sound Name 15	32 – 127 (ASCII)	20	
				0F	1		reserved			
				10	1		reserved			
				11	1	00 – 01	Zone Mode Switch	Off, On	00	
				12	1	00 – 01	Advanced Zone Mode Switch	Off, On	00	
				13	2	00 – 12 00 – 60	Tempo	42.0 – 240.0	0704	
				15	1	34 – 4C	Sound Transpose	-12 – +12	40	
				16	1	01 – 7F	Split Point	C#-2 – G8	37	
				17	1		reserved			
				18	1	00 – 01	Bend Lever Mode	Pitch Bend, Rotary S/F	00	
				19	1	00 – 3F, 41, 43 – 77	Modulation Lever Assign	Off, 1 – 63, 65, 67 – 119, 120 (USB Audio Volume)	01	Sustain (= 64), and Sostenuato (= 66) cannot be assigned.
				1A	1	00 – 7F	Modulation Lever Limit Low	0 – 127	00	
				1B	1	00 – 7F	Modulation Lever Limit High	0 – 127	7F	
				1C	1	00 – 3F, 41, 43 – 78	FC1 Assign	Off, 1 – 63, 65, 67 – 119, 120 (USB Audio Volume)	0B	Sustain (= 64), and Sostenuato (= 66) cannot be assigned.
				1D	1	00 – 7F	FC1 Limit Low	0 – 127	00	
				1E	1	00 – 7F	FC1 Limit High	0 – 127	7F	
				1F	1	00 – 3F, 41, 43 – 78	FC2 Assign	Off, 1 – 63, 65, 67 – 119, 120 (USB Audio Volume)	04	Sustain (= 64), and Sostenuato (= 66) cannot be assigned.
				20	1	00 – 7F	FC2 Limit Low	0 – 127	00	
				21	1	00 – 7F	FC2 Limit High	0 – 127	7F	
				22	1	00 – 01	Sustain Pedal Mode	Sustain, Rotary S/F	00	
				23	1		reserved			
				24	1		reserved			
				25	1	00 – 01	Keys A/B Select	A, B	00	
				26	1	00 – 01	Reverb Switch	Off, On	00	
				27	1	00 – 03	Reverb Depth Knob Section Select	All, Organ, Keys A, Keys B	01	

Address			Size	Data Range	Parameter Name	Description	Default (HEX)	Notes		
High	Mid	Low					YC61			
				28	1		reserved			
				29	1		reserved			
				2A	1	00 – 01	Effect Switch	Off, On	00	
				2B	1	00 – 15, 17 – 1F, 21	Effect Type	*1	00	For LED display, see "Insertion Effect Type List" (page 32).
				2C	1	00 – 02	Effect Section Select	Organ, Keys A, Keys B	00	
				2D	1	00 – 7F	Effect Depth	0 – 127	40	
				2E	1	00 – 7F	Effect Rate	0 – 127	40	
				2F	1	00 – 0E	Effect Tempo Delay Time	1/32 Tri., 1/64 Dot., 1/32, 1/16 Tri., 1/32 Dot., 1/16, 1/8 Tri., 1/16 Dot., 1/8, 1/4 Tri., 1/8 Dot., 1/4, 1/2 Tri., 1/4 Dot., 1/2	0B	
				30	1	00 – 01	Effect Looper Delay Rec Switch	Off, On	01	
				31	1	00 – 01	Speaker/Amp Switch	Off, On	01	
				32	1	00 – 05	Speaker/Amp Type	Rotary Speaker A, Rotary Speaker B, UK Lead, UK Crunch, US Double, US Case	00	
				33	1	00 – 02	Speaker/Amp Section Select	Organ, Keys A, Keys B	00	
				34	1	00 – 7F	Speaker/Amp Drive	0 – 127	40	
				35	1	00 – 7F	Speaker/Amp Tone	0 – 127	40	
				36	1	00 – 01	Rotary Speaker Slow/Fast	Slow, Fast	00	
				37	1	00 – 01	Rotary Speaker Rotation Switch	Off, On	01	
				38	1	00 – 7F	Rotary Speaker Horn Level	0 – 127	40	
				39	1	00 – 7F	Rotary Speaker Rotor Level	0 – 127	40	
				3A	1	01 – 7F	Rotary Speaker Horn Speed Fast	209.4 – 817.6 [rpm]	40	
				3B	1	01 – 7F	Rotary Speaker Rotor Speed Fast	189.3 – 736.8 [rpm]	40	
				3C	1	01 – 7F	Rotary Speaker Horn Speed Slow	23.0 – 89.6 [rpm]	40	
				3D	1	01 – 7F	Rotary Speaker Rotor Speed Slow	22.7 – 88.3 [rpm]	40	
				3E	1	0E – 7F	Rotary Speaker Horn Acceleration	0.21 – 1.00 – 2.00	53	
				3F	1	0E – 7F	Rotary Speaker Rotor Acceleration	0.21 – 1.00 – 2.00	40	
				40	1	0E – 7F	Rotary Speaker Horn Deceleration	0.21 – 1.00 – 2.00	53	
				41	1	0E – 7F	Rotary Speaker Rotor Deceleration	0.21 – 1.00 – 2.00	40	
				42	1	00 – 01	Rotary Speaker Stereo/Mono	Stereo, Mono	00	
				43	1	00 – 01	Background Noise Switch	Off, On	01	
				44	1	00 – 7F	Background Noise Level	0 – 127	40	
				45	1		reserved			
				46	1		reserved			
				47	1		reserved			

TOTAL SIZE = 72 48 (HEX)

*1: G Chorus, SPX Chorus, Symphonic, 816 Chorus, VCM Flanger, Cross FB Flanger, VCM Stereo Phaser, Small Phaser, Max90, Dual Phaser, Tremolo, Auto Pan, Simple Rotary, British Combo, British Lead, Small Stereo, Compressor, Auto Wah, Touch Wah, Pedal Wah, Cross Delay, Tempo Delay, Analog Delay, Looper Delay, Room Reverb, Hall Reverb, Reverse Reverb, Lo-Fi, Ring Modulator, Slicer, LP Filter, Harmonic Enhancer

ZONE

Zone 1-4

zz: Zone Number, 00 – 03 (HEX)

Group Number = 7F 1C, Model ID = 09

Address			Size	Data Range	Parameter Name	Description	Default (HEX) YC61	Notes
High	Mid	Low						
4A	zz	00	1	00 – 01	Zone Switch	Off, On	00 – 01	With the default settings, only the Zone 1 is set to "on."
		01	1	00 – 0F	Transmit Channel	1 – 16	00 – 03	Default settings: Zone 1 (0), Zone 2 (1), Zone 3 (2), Zone 4 (3)
		02	1	3D – 43	Transpose (Octave)	-3 – +3	40	
		03	1	35 – 4B	Transpose (Semitone)	-11 – +11	40	
		04	1	00 – 7F	Note Limit Low	C-2 – G8	00	The upper limit will be determined with "Note Limit High."
		05	1	00 – 7F	Note Limit High	C-2 – G8	7F	The lower limit will be determined with "Note Limit Low."
		06	1		reserved			
		07	1	00 – 7F	MIDI Volume	0 – 127	7F	
		08	1	00 – 7F	MIDI Pan	L64 – C – R63	40	
		09	1	00 – 7F	MIDI Bank MSB	0 – 127	00	
		0A	1	00 – 7F	MIDI Bank LSB	0 – 127	00	
		0B	1	00 – 7F	MIDI Program Number	1 – 128	00	
		0C	1	00 – 1F	Transmit Bank Select Transmit Program Change Transmit Volume Transmit Pan Transmit Note	bit0: Off, On Bank Select bit1: Off, On Program Change bit2: Off, On Volume bit3: Off, On Pan bit4: Off, On Note	1F	CC#11 (Expression) will not be transmitted when the Volume is set to "off."
		0D	1	00 – 3F	Transmit PB Transmit Mod Transmit FC1 Transmit FC2 Transmit FS Transmit Sus	bit0: Off, On PB bit1: Off, On Mod bit2: Off, On FC1 bit3: Off, On FC2 bit4: Off, On FS bit5: Off, On Sus	3F	
		0E	1		reserved			
		0F	1		reserved			

TOTAL SIZE = 16 10 (HEX)

Organ Section

Organ Section Common

Group Number = 7F 1C, Model ID = 09

Address			Size	Data Range	Parameter Name	Description	Default (HEX) YC61	Notes
High	Mid	Low						
50	00	00	2	00 – 00 00 – 05	Voice Number	H1, H2, H3, F1, F2, F3 1st bit6-0 → bit13-7 2nd bit6-0 → bit6-0	00 00	
		02	1	00 – 01	Section Switch	Off, On	01	
		03	1	00 – 01	Part Select	Upper, Lower	00	
		04	1	00 – 03	Split Mode	Off, L&U, Upper, Lower	00	
		05	1	00 – 7F	Section Volume	0 – 127	7F	
		06	1	00 – 7F	Pre Drive	0 – 127	00	
		07	1		reserved			
		08	1	28 – 58	Pitch Bend Range	-24 – 0 – +24	42	
		09	1	00 – 7F	Pitch Modulation Depth	0 – 127	0A	*1
		0A	1	00 – 7F	Pitch Modulation Speed	-64 – +63	40	*1

Address			Size	Data Range	Parameter Name	Description	Default (HEX) YC61	Notes
High	Mid	Low						
		0B	1		reserved			
		0C	1	00 – 01	Receive Expression	Off, On	01	
		0D	1	00 – 01	Receive Sustain	Off, On	01	
		0E	1	00 – 01	Receive Sostenuto	Off, On	01	
		0F	1		reserved			
		10	1	00 – 04	External Keyboard	External + Internal, External Only, 2 manual (Upper), 2 manual (Lower), Off	00	
		11	1		reserved			
		12	1		reserved			
		13	1	00 – 01	Percussion Switch	Off, On	00	*2
		14	1	00 – 01	Percussion Type	3rd, 2nd	00	*2
		15	1	00 – 01	Percussion Decay	Slow, Fast	00	*2
		16	1	00 – 01	Percussion Volume	Soft, Normal	01	*2
		17	1	00 – 01	Percussion Link to 1feet	Off, On	01	*2
		18	1		reserved			
		19	1		reserved			
		1A	1	00 – 05	Vibrato/Chorus Type	V1, C1, V2, C2, V3, C3	05	*2
		1B	1		reserved			
		1C	1	00 – 7F	Leak Level	0 – 127	40	*2
		1D	1	00 – 7F	Key Click Level	0 – 127	40	*2
		1E	1		reserved			
		1F	1	00 – 01	Expression Type	Drive+Volume, Volume	00	*2
		20	1		reserved			
		21	1		reserved			
		22	1		reserved			
		23	1	00 – 7F	Reverb Depth	0 – 127	00	

TOTAL SIZE = 36 24 (HEX)

* 1: Effective only when the FM organ type (F1-F3) is selected.
* 2: Effective only when the VCM organ type (H1-H3) is selected.

Organ Section Part Upper/Lower

p: Part number, 0-1 (0: Upper, 1: Lower)

Address			Size	Data Range	Parameter Name	Description	Default (HEX) YC61	Note
High	Mid	Low						
50	1p	00	1		reserved			
		01	1		reserved			
		02	1	3E – 42	Octave Shift	-2 – 0 – +2	40	
		03	1		reserved			
		04	1	00 – 7F	Drawbar 16'	0 – 127	7F	Correspondence between drawbar position and parameter value 0: 0 1: 1 - 18 2: 19 - 36 3: 37 - 54 4: 55 - 72 5: 73 - 90 6: 91 - 108 7: 109 - 126 8: 127
		05	1	00 – 7F	Drawbar 5 1/3'	0 – 127	7F	
		06	1	00 – 7F	Drawbar 8'	0 – 127	7F	
		07	1	00 – 7F	Drawbar 4'	0 – 127	00	
		08	1	00 – 7F	Drawbar 2 2/3'	0 – 127	00	
		09	1	00 – 7F	Drawbar 2'	0 – 127	00	
		0A	1	00 – 7F	Drawbar 1 3/5'	0 – 127	00	
		0B	1	00 – 7F	Drawbar 1 1/3'	0 – 127	00	
		0C	1	00 – 7F	Drawbar 1'	0 – 127	00	
		0D	1	00 – 06	Drawbar Color	1: White, 2: Red, 3: Yellow, 4: Green, 5: Cyan, 6: Blue, 7: Magenta	06	
		0E	1		reserved			
		0F	1		reserved			
		10	1		reserved			
		11	1		reserved			
		12	1	00 – 01	Vibrato/Chorus Switch	Off, On	00	
		13	1		reserved			

TOTAL SIZE = 20 14 (HEX)

Keys Sections

Key A/Key B Section

s: Section number, 0-1 (0: A, 1: B)

Group Number = 7F 1C, Model ID = 09

Address			Size	Data Range	Parameter Name	Description	Default (HEX)	Notes
High	Mid	Low					YC61	
60	0s	00	1	00 – 03	Current Category	Piano, E.Piano, Synth, Others	A: 00, B: 02	
		01	2	00 – 00 06 – 0D	Category 1 Voice Number	6 – 13 1st bit6-0 → bit13-7 2nd bit6-0 → bit6-0	00 06	
		03	2	00 – 00 0E – 1F	Category 2 Voice Number	14 – 31 1st bit6-0 → bit13-7 2nd bit6-0 → bit6-0	00 0E	
		05	2	00 – 00 20 – 5A	Category 3 Voice Number	32 – 90 1st bit6-0 → bit13-7 2nd bit6-0 → bit6-0	00 20	
		07	2	00 – 01 00 – 7F	Category 4 Voice Number	90 – 144 1st bit6-0 → bit13-7 2nd bit6-0 → bit6-0	00 5B	
		09	1		reserved			
		0A	1	00 – 01	Section Switch	Off, On	00	
		0B	1	00 – 02	Split Mode	L&R, L, R	00	
		0C	1	3E – 42	Octave Shift	-2 – 0 – +2	40	
		0D	1		reserved			
		0E	1	00 – 7F	Section Volume	0 – 127	7F	
		0F	1	00 – 7F	Tone	0 – 127	40	
		10	1	00 – 01	EG/Filter Select	EG, Filter	00	
		11	1	00 – 7F	EG	0 – 127	40	
		12	1	00 – 0A	EG Control	Atk&Dcy&Rls A, Atk&Dcy&Rls B, Attack, Decay, Release, Atk&Rls A, Atk&Rls B, Atk&Rls Minus, Dcy&Rls, Atk&Dcy A, Atk&Dcy B	00	
		13	1	00 – 7F	Filter	0 – 127	40	
		14	1	00 – 06	Filter Control	Flat Reso, Reso Plus, Reso Minus A, Reso Minus B, Reso Minus C, Reso Boost A, Reso Boost B	00	
		15	1		reserved			
		16	1		reserved			
		17	1	00 – 02	FM Unison	Off, 2 Unison, 4 Unison	00	*1
		18	1	00 – 0F	FM Detune	0 – 15	00	*1
		19	1	00 – 0F	FM Spread	0 – 15	00	*1
		1A	1		reserved			
		1B	1		reserved			
		1C	1	00 – 01	Mono/Poly	Mono, Poly	01	
		1D	1	00 – 01	Portamento Switch	Off, On	00	*2
		1E	1	00 – 7F	Portamento Time	0 – 127	40	*2
		1F	1	00 – 01	Portamento Mode	Fingered, Full-time	01	*2
		20	1	00 – 01	Portamento Time Mode	Rate, Time	00	*2
		21	1	28 – 58	Pitch Bend Range	-24 – 0 – +24	42	
		22	1	00 – 7F	Pitch Modulation Depth	0 – 127	0A	
		23	1	00 – 7F	Pitch Modulation Speed	-64 – +63	40	
		24	1		reserved			
		25	1		reserved			
		26	1	00 – 01	Receive Expression	Off, On	01	
		27	1	00 – 01	Receive Sustain	Off, On	01	
		28	1	00 – 01	Receive Sostenuto	Off, On	01	
		29	1	00 – 01	Receive Soft	Off, On	01	
		2A	1	00 – 02	External Keyboard	External + Internal, External Only, Off	00	
		2B	1		reserved			
		2C	1		reserved			
		2D	1	00 – 01	Effect 1 Switch	Off, On	00	

Address			Size	Data Range	Parameter Name	Description	Default (HEX)	Notes	
High	Mid	Low					YC61		
			2E	1	00 – 14, 16 – 17, 19 – 21	Effect 1 Type	*3	00	For LED display, see "Insertion Effect Type List" (page 32).
			2F	1	00 – 7F	Effect 1 Depth	0 – 127	40	
			30	1	00 – 7F	Effect 1 Rate	0 – 127	40	
			31	1	00 – 01	Effect 2 Switch	Off, On	00	
			32	1	00 – 14, 16 – 17, 19 – 21	Effect 2 Type	*3	00	For LED display, see "Insertion Effect Type List" (page 32).
			33	1	00 – 7F	Effect 2 Depth	0 – 127	40	
			34	1	00 – 7F	Effect 2 Speed	0 – 127	40	
			35	1		reserved			
			36	1		reserved			
			37	1		reserved			
			38	1		reserved			
			39	1	00 – 7F	Reverb Depth	0 – 127	00	

TOTAL SIZE = 58

3A (HEX)

*1: Effective only when the FM organ type (F1-F3) is selected.

*2: Effective only when the VCM organ type (H1-H3) is selected.

*3: G Chorus, SPX Chorus, Symphonic, 816 Chorus, VCM Flanger, Cross FB Flanger, VCM Stereo Phaser, Small Phaser, Max90, Dual Phaser, Tremolo, Auto Pan, Simple Rotary, British Combo, British Lead, Small Stereo, Compressor, Auto Wah, Touch Wah, Pedal Wah, Cross Delay, Digital Delay, Analog Delay, Room Reverb, Hall Reverb, Reverse Reverb, Lo-Fi, Ring Modulator, Slicer, LP Filter, Damper Resonance, Harmonic Enhancer

YAMAHA [Stage Keyboard]
Model YC61 MIDI Implementation Chart

Date :25-SEP-2019
Version : 1.0

Function...	Transmitted	Recognized	Remarks	
Basic Channel	Default Changed	1 - 16 1 - 16	1 - 16 1 - 16	Memorized
Mode	Default Messages Altered	3 X *****	3 X X	Memorized
Note Number : True voice		0 - 127 *****	0 - 127 0 - 127	
Velocity	Note On Note Off	O 9nH, v=1-127 X 8nH, v=64	O 9nH, v=1-127 O 9nH, v=0 or 8nH	
After Touch	Key's Ch's	X X	X X	
Pitch Bend		O	O	
Control Change	0,32 1 7,11,67,84 64 66 13,14 18-25,27-31 68-70 79-83 85-91 93,94 102-119 1-119	O *2 O X O X O *1 O *1 O *1 O *1 O *1 O *1 O *1 O *1 O *3	O *2 O O O *2 O *2 O *1 O *1 O *1 O *1 O *1 O *1 O *1 X	Bank Select Sustain Sw Sostenuto
Prog Change : True #		O 0 - 127 *2	O 0 - 7 *2	
System Exclusive		O	O	
Common	: Song Pos. : Song Sel. : Tune	X X X	X X X	
System	: Clock Real Time : Commands	X X	X X	
Aux	: All Sound Off : Reset All Cntrls : Local On/Off Mes- : All Notes Off sages: Active Sense : Reset	X X X X O X	O (120) O (121) X O (123-125) O X	
Notes: *1 receive/transmit if MIDI control mode is on. *2 receive/transmit if switch is on. *3 transmit if assigned to controllers.				

Mode 1 : OMNI ON , POLY
Mode 3 : OMNI OFF, POLY

Mode 2 : OMNI ON ,MONO
Mode 4 : OMNI OFF,MONO

O : Yes
X : No

Apache License 2.0

Copyright (c) 2009-2018 Arm Limited. All rights reserved.

SPDX-License-Identifier: Apache-2.0

Licensed under the Apache License, Version 2.0 (the License); you may not use this file except in compliance with the License. You may obtain a copy of the License at www.apache.org/licenses/LICENSE-2.0

Unless required by applicable law or agreed to in writing, software distributed under the License is distributed on an AS IS BASIS, WITHOUT WARRANTIES OR CONDITIONS OF ANY KIND, either express or implied. See the License for the specific language governing permissions and limitations under the License.

The Clear BSD license

The Clear BSD License
Copyright 1997-2016 Freescale Semiconductor, Inc.
Copyright 2016-2018 NXP
All rights reserved.

Redistribution and use in source and binary forms, with or without modification, are permitted (subject to the limitations in the disclaimer below) provided that the following conditions are met:

Redistributions of source code must retain the above copyright notice, this list of conditions and the following disclaimer.

Redistributions in binary form must reproduce the above copyright notice, this list of conditions and the following disclaimer in the documentation and/or other materials provided with the distribution.

Neither the name of the copyright holder nor the names of its contributors may be used to endorse or promote products derived from this software without specific prior written permission.

NO EXPRESS OR IMPLIED LICENSES TO ANY PARTY'S PATENT RIGHTS ARE GRANTED BY THIS LICENSE. THIS SOFTWARE IS PROVIDED BY THE COPYRIGHT HOLDERS AND CONTRIBUTORS "AS IS" AND ANY EXPRESS OR IMPLIED WARRANTIES, INCLUDING, BUT NOT LIMITED TO, THE IMPLIED WARRANTIES OF MERCHANTABILITY AND FITNESS FOR A PARTICULAR PURPOSE ARE DISCLAIMED. IN NO EVENT SHALL THE COPYRIGHT HOLDER OR CONTRIBUTORS BE LIABLE FOR ANY DIRECT, INDIRECT, INCIDENTAL, SPECIAL, EXEMPLARY, OR CONSEQUENTIAL DAMAGES (INCLUDING, BUT NOT LIMITED TO, PROCUREMENT OF SUBSTITUTE GOODS OR SERVICES; LOSS OF USE, DATA, OR PROFITS; OR BUSINESS INTERRUPTION) HOWEVER CAUSED AND ON ANY THEORY OF LIABILITY, WHETHER IN CONTRACT, STRICT LIABILITY, OR TORT (INCLUDING NEGLIGENCE OR OTHERWISE) ARISING IN ANY WAY OUT OF THE USE OF THIS SOFTWARE, EVEN IF ADVISED OF THE POSSIBILITY OF SUCH DAMAGE.

MEMO

MEMO



**Important Notice:
U.S. LIMITED WARRANTY for Customers in the United States**

For detailed information about this Yamaha product and warranty service, please either visit the following website address (printable file is available at our website) or contact Customer Service at the address or telephone number identified below.

Website Address:

Yamaha.io/SynthAndStageWarranty

Customer Service:

Yamaha Corporation of America
6600 Orangethorpe Avenue, Buena Park, CA 90620-1273
Telephone: 800-854-1569

Important Notice: Guarantee Information for customers in European Economic Area (EEA) and Switzerland

Important Notice: Guarantee Information for customers in EEA* and Switzerland For detailed guarantee information about this Yamaha product, and Pan-EEA* and Switzerland warranty service, please either visit the website address below (Printable file is available at our website) or contact the Yamaha representative office for your country. * EEA: European Economic Area	English
Wichtiger Hinweis: Garantie-Information für Kunden in der EWR* und der Schweiz Für nähere Garantie-Information über dieses Produkt von Yamaha, sowie über den Pan-EWR*- und Schweizer Garantieservice, besuchen Sie bitte entweder die folgend angegebene Internetadresse (eine druckfähige Version befindet sich auch auf unserer Webseite), oder wenden Sie sich an den für Ihr Land zuständigen Yamaha-Vertrieb. *EWR: Europäischer Wirtschaftsraum	Deutsch
Remarque importante: informations de garantie pour les clients de l'EEE et la Suisse Pour des informations plus détaillées sur la garantie de ce produit Yamaha et sur le service de garantie applicable dans l'ensemble de l'EEE ainsi qu'en Suisse, consultez notre site Web à l'adresse ci-dessous (le fichier imprimable est disponible sur notre site Web) ou contactez directement Yamaha dans votre pays de résidence. * EEE : Espace Economique Européen	Français
Belangrijke mededeling: Garantie-informatie voor klanten in de EER* en Zwitserland Voor gedetailleerde garantie-informatie over dit Yamaha-product en de garantieservice in heel de EER* en Zwitserland, gaat u naar de onderstaande website (u vindt een afdrukbaar bestand op onze website) of neemt u contact op met de vertegenwoordiging van Yamaha in uw land. * EER: Europese Economische Ruimte	Nederlands
Aviso importante: información sobre la garantía para los clientes del EEE* y Suiza Para una información detallada sobre este producto Yamaha y sobre el soporte de garantía en la zona EEE* y Suiza, visite la dirección web que se incluye más abajo (la versión del archivo para imprimir esta disponible en nuestro sitio web) o póngase en contacto con el representante de Yamaha en su país. * EEE: Espacio Económico Europeo	Español
Avviso importante: informazioni sulla garanzia per i clienti residenti nell'EEA* e in Svizzera Per informazioni dettagliate sulla garanzia relativa a questo prodotto Yamaha e l'assistenza in garanzia nei paesi EEA* e in Svizzera, potete consultare il sito Web all'indirizzo riportato di seguito (è disponibile il file in formato stampabile) oppure contattare l'ufficio di rappresentanza locale della Yamaha. * EEA: Area Economica Europea	Italiano
Aviso importante: informações sobre as garantias para clientes da AEE* e da Suíça Para obter uma informação pormenorizada sobre este produto da Yamaha e sobre o serviço de garantia na AEE* e na Suíça, visite o site a seguir (o arquivo para impressão está disponível no nosso site) ou entre em contato com o escritório de representação da Yamaha no seu país. * AEE: Área Económica Europeia	Português
Σημαντική σημείωση: Πληροφορίες εγγύησης για τους πελάτες στον ΕΟΧ* και Ελλάδα Για λεπτομερείς πληροφορίες εγγύησης σχετικά με το παρόν προϊόν της Yamaha και την κάλυψη εγγύησης σε όλες τις χώρες του ΕΟΧ και την Ελλάδα, επισκεφτείτε την παρακάτω ιστοσελίδα (Εκτυπώσιμη μορφή είναι διαθέσιμη στην ιστοσελίδα μας) ή απευθυνθείτε στην αντιπροσωπεία της Yamaha στη χώρα σας. * ΕΟΧ: Ευρωπαϊκός Οικονομικός Χώρος	Ελληνικά
Viktigt: Garantiinformation för kunder i EES-området* och Schweiz För detaljerad information om denna Yamahaprodukt samt garantiservice i hela EES-området* och Schweiz kan du antingen besöka nedanstående webbadress (en utskriftsvänlig fil finns på webbplatsen) eller kontakta Yamahas officiella representant i ditt land. * EES: Europeiska Ekonomiska Samarbetsområdet	Svenska
Viktig merknad: Garantiinformasjon for kunder i EØS* og Sveits Detaljert garantiinformasjon om dette Yamaha-produktet og garantiservice for hele EØS-området* og Sveits kan fås enten ved å besøke nettstedene nedenfor (utskriftsversjon finnes på våre nettsider) eller kontakte Yamahas kontoret i landet der du bor. *EØS: Det europeiske økonomiske samarbeidsområdet	Norsk
Vigtig oplysning: Garantioplysninger til kunder i EØ* og Schweiz De kan finde detaljerede garantioplysninger om dette Yamaha-produkt og den fælles garantiserviceordning for EØ* (og Schweiz) ved at besøge det websted, der er angivet nedenfor (der findes en fil, som kan udskrives, på vores websted), eller ved at kontakte Yamahas nationale repræsentationskontor i det land, hvor De bor. * EØ: Det Europæiske Økonomiske Område	Dansk
Tärkeä ilmoitus: Takuutiedot Euroopan talousalueen (ETA)* ja Sveitsin asiakkaille Tämän Yamaha-tuotteen sekä ETA-alueen ja Sveitsin takuuta koskevat yksityiskohtaiset tiedot saatte alla olevasta nettiosoitteesta. (Tulostettava tiedosto saatavissa sivustollamme.) Voitte myös ottaa yhteyttä paikalliseen Yamaha-edustajaan. *ETA: Euroopan talousalue	Suomi
Ważne: Warunki gwarancyjne obowiązujące w EOG* i Szwajcarii Aby dowiedzieć się więcej na temat warunków gwarancyjnych tego produktu firmy Yamaha i serwisu gwarancyjnego w całym EOG* i Szwajcarii, należy odwiedzić wskazaną poniżej stronę internetową (Plik gotowy do wydruku znajduje się na naszej stronie internetowej) lub skontaktować się z przedstawicielstwem firmy Yamaha w swoim kraju. * EOG — Europejski Obszar Gospodarczy	Polski
Důležité oznámení: Záruční informace pro zákazníky v EHS* a ve Švýcarsku Podrobné záruční informace o tomto produktu Yamaha a záručním servisu v celém EHS* a ve Švýcarsku naleznete na níže uvedené webové adrese (soubor k tisku je dostupný na našich webových stránkách) nebo se můžete obrátit na zastoupení firmy Yamaha ve své zemi. * EHS: Evropský hospodářský prostor	Česky
Fontos figyelemzetés: Garancia-információk az EGT* területén és Svájcban élő vásárlók számára A jelen Yamaha termékre vonatkozó részletes garancia-információk, valamint az EGT*-re és Svájcra kiterjedő garanciális szolgáltatás tekintetében keresse fel webhelyünket az alábbi címen (a webhelyen nyomtatható fájl is található), vagy pedig lépjen kapcsolatba az országában működő Yamaha képviselői irodával. * EGT: Európai Gazdasági Térség	Magyar
Oluline märkus: Garantiiteave Euroopa Majanduspiirkonna (EMP)* ja Šveitsi klientidele Täpsemat teabes saamiseks selle Yamaha toote garantii ning kogu Euroopa Majanduspiirkonna ja Šveitsi garantiiteeninduse kohta, külastage palun veebisaiti alljärgneval aadressil (meie saidil on saadaval printitav fail) või pöörduge Teie regiooni Yamaha esinduse poole. * EMP: Euroopa Majanduspiirkond	Eesti keel
Svarīgs paziņojums: garantijas informācija klientiem EEZ* un Šveicē Lai saņemtu detalizētu garantijas informāciju par šo Yamaha produktu, kā arī garantijas apkalpošanu EEZ* un Šveicē, lūdzmu, apmeklējiet zemāk norādīto tīmekļa vietnes adresi (tīmekļa vietnē ir pieejams drukājams fails) vai sazinieties ar jūsu valsti apkalpojošo Yamaha pārstāvniecību. * EEZ: Eiropas Ekonomikas zona	Latviešu
Dėmesio: informacija dėl garantijos pirkėjams EEE* ir Šveicarijoje Jei reikia išsamios informacijos apie šį „Yamaha“ produktą ir jo techninę priežiūrą visoje EEE* ir Šveicarijoje, apsilankykite mūsų svetainėje toliau nurodytu adresu (svetainėje yra spausdintinas failas) arba kreipkitės į „Yamaha“ atstovybę savo šaliai. *EEE – Europos ekonominė erdvė	Lietuvių kalba
Dôležité upozornenie: Informácie o záruke pre zákazníkov v EHP* a Švajčiarsku Podrobné informácie o záruke týkajúce sa tohto produktu od spoločnosti Yamaha a garančnom servise v EHP* a Švajčiarsku nájdete na webovej stránke uvedenej nižšie (na našej webovej stránke je k dispozícii súbor na tlač) alebo sa obráťte na zástupcu spoločnosti Yamaha vo svojej krajine. * EHP: Európsky hospodársky priestor	Slovenčina
Pomembno obvestilo: Informacije o garanciji za kupce v EGP* in Švici Za podrobnejše informacije o tem Yamahinem izdelku ter garancijskem servisu v celotnem EGP in Švici, obiščite spletno mesto, ki je navedeno spodaj (natisljiva datoteka je na voljo na našem spletnem mestu), ali se obrnite na Yamahinega predstavnika v svoji državi. * EGP: Evropski gospodarski prostor	Slovenščina
Важно съобщение: Информация за гаранцията за клиенти в ЕИП* и Швейцария За подробна информация за гаранцията за този продукт на Yamaha и гаранционното обслужване в паневропейската зона на ЕИП* и Швейцария или посетете посочения по-долу уеб сайт (на нашия уеб сайт има файл за печат), или се свържете с представителния офис на Yamaha във вашата страна. * ЕИП: Европейско икономическо пространство	Български език
Notificare importantă: Informații despre garanție pentru clienții din SEE* și Elveția Pentru informații detaliate privind acest produs Yamaha și serviciul de garanție Pan-SEE* și Elveția, vizitați site-ul la adresa de mai jos (fișierul imprimabil este disponibil pe site-ul nostru) sau contactați biroul reprezentanței Yamaha din țara dumneavoastră. * SEE: Spațiul Economic European	Limba română
Važna obavijest: Informacije o jamstvu za države EGP-a i Švicarske Za detaljne informacije o jamstvu za ovaj Yamahin proizvod te jamstvenom servisu za cijeli EGP i Švicarsku, molimo Vas da posjetite web-stranicu navedenu u nastavku ili kontaktirate ovlaštenog Yamahinog dobavljača u svojoj zemlji. * EGP: Europski gospodarski prostor	Hrvatski

<https://europe.yamaha.com/warranty/>

For details of products, please contact your nearest Yamaha representative or the authorized distributor listed below.

Pour plus de détails sur les produits, veuillez-vous adresser à Yamaha ou au distributeur le plus proche de vous figurant dans la liste suivante.

Die Einzelheiten zu Produkten sind bei Ihrer unten aufgeführten Niederlassung und bei Yamaha Vertragshändlern in den jeweiligen Bestimmungsländern erhältlich.

Para detalles sobre productos, contacte su tienda Yamaha más cercana o el distribuidor autorizado que se lista debajo.

NORTH AMERICA

CANADA

Yamaha Canada Music Ltd.
135 Milner Avenue, Toronto, Ontario M1S 3R1,
Canada
Tel: +1-416-298-1311

U.S.A.

Yamaha Corporation of America
6600 Orangethorpe Avenue, Buena Park, CA 90620,
U.S.A.
Tel: +1-714-522-9011

CENTRAL & SOUTH AMERICA

MEXICO

Yamaha de México, S.A. de C.V.
Av. Insurgentes Sur 1647 Piso 9, Col. San José
Insurgentes, Delegación Benito Juárez, México,
D.F., C.P. 03900, México
Tel: +52-55-5804-0600

BRAZIL

Yamaha Musical do Brasil Ltda.
Rua Fidêncio Ramos, 302 – Cj 52 e 54 – Torre B –
Vila Olimpia – CEP 04551-010 – São Paulo/SP,
Brazil
Tel: +55-11-3704-1377

ARGENTINA

**Yamaha Music Latin America, S.A.,
Sucursal Argentina**
Olga Cossetini 1553, Piso 4 Norte,
Madero Este-C1107CEK,
Buenos Aires, Argentina
Tel: +54-11-4119-7000

PANAMA AND OTHER LATIN AMERICAN COUNTRIES/ CARIBBEAN COUNTRIES

Yamaha Music Latin America, S.A.
Edificio Torre Davivienda, Piso: 20
Avenida Balboa, Marbella, Corregimiento de Bella
Vista, Ciudad de Panamá, Rep. de Panamá
Tel: +507-269-5311

EUROPE

THE UNITED KINGDOM/IRELAND

Yamaha Music Europe GmbH (UK)
Sherbourne Drive, Tilbrook, Milton Keynes,
MK7 8BL, U.K.
Tel: +44-1908-366700

GERMANY

Yamaha Music Europe GmbH
Siemensstrasse 22-34, 25462 Rellingen, Germany
Tel: +49-4101-303-0

SWITZERLAND/LIECHTENSTEIN

**Yamaha Music Europe GmbH, Branch
Switzerland in Thalwil**
Seestrasse 18a, 8800 Thalwil, Switzerland
Tel: +41-44-3878080

AUSTRIA/CROATIA/CZECH REPUBLIC/ HUNGARY/ROMANIA/SLOVAKIA/ SLOVENIA

Yamaha Music Europe GmbH, Branch Austria
Schleiergasse 20, 1100 Wien, Austria
Tel: +43-1-60203900

POLAND

Yamaha Music Europe GmbH
Sp.z o.o. Oddział w Polsce
ul. Wielicka 52, 02-657 Warszawa, Poland
Tel: +48-22-880-08-88

BULGARIA

Dinacord Bulgaria LTD.
Bul. Iskarsko Schose 7 Targowski Zentar Ewropa
1528 Sofia, Bulgaria
Tel: +359-2-978-20-25

MALTA

Olimpus Music Ltd.
Valletta Road, Mosta MST9010, Malta
Tel: +356-2133-2093

NETHERLANDS/BELGIUM/ LUXEMBOURG

Yamaha Music Europe, Branch Benelux
Clarissenhof 5b, 4133 AB Vianen, The Netherlands
Tel: +31-347-358040

FRANCE

Yamaha Music Europe
7 rue Ambroise Croizat, Zone d'activités de Pariest,
77183 Croissy-Beaubourg, France
Tel: +33-1-6461-4000

ITALY

Yamaha Music Europe GmbH, Branch Italy
Via Tinelli N.67/69 20855 Gerno di Lesmo (MB),
Italy
Tel: +39-039-9065-1

SPAIN/PORTUGAL

**Yamaha Music Europe GmbH Ibérica, Sucursal
en España**
Ctra. de la Coruña km. 17,200, 28231
Las Rozas de Madrid, Spain
Tel: +34-91-639-88-88

GREECE

Philippos Nakas S.A. The Music House
19th klm. Leof. Lavriou 190 02 Peania – Attiki,
Greece
Tel: +30-210-6686260

SWEDEN

**Yamaha Music Europe GmbH Germany filial
Scandinavia**
JA Wettergrensgata 1, 400 43 Göteborg, Sweden
Tel: +46-31-89-34-00

DENMARK

**Yamaha Music Denmark,
Fillial of Yamaha Music Europe GmbH, Tyskland**
Generatorvej 8C, ST. TH., 2860 Søborg, Denmark
Tel: +45-44-92-49-00

FINLAND

F-Musiikki Oy
Antaksentie 4
FI-01510 Vantaa, Finland
Tel: +358 (0)96185111

NORWAY

**Yamaha Music Europe GmbH Germany -
Norwegian Branch**
Grini Næringspark 1, 1332 Østerås, Norway
Tel: +47-6716-7800

ICELAND

Hljóðfaerhusid Ehf.
Sidumula 20
IS-108 Reykjavik, Iceland
Tel: +354-525-5050

CYPRUS

Nakas Music Cyprus Ltd.
Nikis Ave 2k
1086 Nicosia
Tel: + 357-22-511080
Major Music Center
21 Ali Riza Ave. Ortakoy
P.O.Box 475 Lefkoşa, Cyprus
Tel: (392) 227 9213

RUSSIA

Yamaha Music (Russia) LLC.
Room 37, entrance 7, bld. 7, Kievskaya street,
Moscow, 121059, Russia
Tel: +7-495-626-5005

OTHER EUROPEAN COUNTRIES

Yamaha Music Europe GmbH
Siemensstrasse 22-34, 25462 Rellingen, Germany
Tel: +49-4101-303-0

AFRICA

Yamaha Music Gulf FZE
JAFZA-16, Office 512, P.O.Box 17328,
Jebel Ali FZE, Dubai, UAE
Tel: +971-4-801-1500

MIDDLE EAST

TURKEY

Yamaha Music Europe GmbH
Merkezi Almanya Türkiye İstanbul Şubesi
Mor Sumbul Sokak Varyap Meridian Business
1.Blok No:1 113-114-115
Bati Atasehir İstanbul, Turkey
Tel: +90-216-275-7960

ISRAEL

RBX International Co., Ltd.
P.O Box 10245, Petach-Tikva, 49002
Tel: (972) 3-925-6900

OTHER COUNTRIES

Yamaha Music Gulf FZE
JAFZA-16, Office 512, P.O.Box 17328,
Jebel Ali FZE, Dubai, UAE
Tel: +971-4-801-1500

ASIA

THE PEOPLE'S REPUBLIC OF CHINA

Yamaha Music & Electronics (China) Co., Ltd.
2F, Yunhedasha, 1818 Xinzha-lu, Jingan-qu,
Shanghai, China
Tel: +86-400-051-7700

HONG KONG

Tom Lee Music Co., Ltd.
11/F, Silvercord Tower 1, 30 Canton Road,
Tsimshatsui, Kowloon, Hong Kong
Tel: +852-2737-7688

INDIA

Yamaha Music India Private Limited
P-401, JMD Megapolis, Sector-48, Sohna Road,
Gurugram-122018, Haryana, India
Tel: +91-124-485-3300

INDONESIA

PT. Yamaha Musik Indonesia (Distributor)
Yamaha Music Center Bldg. Jalan Jend. Gatot
Subroto Kav. 4, Jakarta 12930, Indonesia
Tel: +62-21-520-2577

KOREA

Yamaha Music Korea Ltd.
11F, Prudential Tower, 298, Gangnam-daero,
Gangnam-gu, Seoul, 06253, Korea
Tel: +82-2-3467-3300

MALAYSIA

Yamaha Music (Malaysia) Sdn. Bhd.
No.8, Jalan Perbandaran, Kelana Jaya, 47301
Petaling Jaya, Selangor, Malaysia
Tel: +60-3-78030900

SINGAPORE

Yamaha Music (Asia) Private Limited
Block 202 Hougang Street 21, #02-00,
Singapore 530202, Singapore
Tel: +65-6740-9200

TAIWAN

Yamaha Music & Electronics Taiwan Co., Ltd.
2F, No.1, Yuandong Rd., Banqiao Dist.,
New Taipei City 22063, Taiwan (R.O.C.)
Tel: +886-2-7741-8888

THAILAND

Siam Music Yamaha Co., Ltd.
3, 4, 15, 16th Fl., Siam Motors Building,
891/1 Rama 1 Road, Wangmai,
Pathumwan, Bangkok 10330, Thailand
Tel: +66-2215-2622

VIETNAM

Yamaha Music Vietnam Company Limited
15th Floor, Nam A Bank Tower, 201-203 Cach
Mang Thang Tam St., Ward 4, Dist.3,
Ho Chi Minh City, Vietnam
Tel: +84-28-3818-1122

OTHER ASIAN COUNTRIES

[https://asia-latinamerica-mea.yamaha.com/
index.html](https://asia-latinamerica-mea.yamaha.com/index.html)

OCEANIA

AUSTRALIA

Yamaha Music Australia Pty. Ltd.
Level 1, 80 Market Street, South Melbourne,
VIC 3205 Australia
Tel: +61-3-9693-5111

NEW ZEALAND

Music Works LTD
P.O.BOX 6246 Wellesley, Auckland 4680,
New Zealand
Tel: +64-9-634-0099

COUNTRIES AND TRUST

TERRITORIES IN PACIFIC OCEAN

[https://asia-latinamerica-mea.yamaha.com/
index.html](https://asia-latinamerica-mea.yamaha.com/index.html)



Manual Development Group
© 2019 Yamaha Corporation

Published 11/2019 MWMA*.***A0

VCN7200