



Micro Component System

MCR-B043D

OWNER'S MANUAL



CAUTION: READ THIS BEFORE OPERATING YOUR UNIT.

- 1 To assure the finest performance, please read this manual carefully. Keep it in a safe place for future reference.
- 2 Install this unit in a well ventilated, cool, dry, clean place - away from direct sunlight, heat sources, vibration, dust, moisture and cold. For proper ventilation, allow the following minimum clearances.
Top: 15 cm (6 in)
Rear: 10 cm (4 in)
Sides: 10 cm (4 in)
- 3 Locate this unit away from other electrical appliances, motors, or transformers to avoid humming sounds.
- 4 Do not expose this unit to sudden temperature changes from cold to hot, and do not locate this unit in an environment with high humidity (i.e. a room with a humidifier) to prevent condensation inside this unit, which may cause an electrical shock, fire, damage to this unit, and/or personal injury.
- 5 Avoid installing this unit where foreign object may fall onto this unit and/or this unit may be exposed to liquid dripping or splashing. On the top of this unit, do not place:
 - Other components, as they may cause damage and/or discoloration on the surface of this unit.
 - Burning objects (i.e. candles), as they may cause fire, damage to this unit, and/or personal injury.
 - Containers with liquid in them, as they may fall and liquid may cause electrical shock to the user and/or damage to this unit.
- 6 Do not cover this unit with a newspaper, tablecloth, curtain, etc. in order not to obstruct heat radiation. If the temperature inside this unit rises, it may cause fire, damage to this unit, and/or personal injury.
- 7 Do not plug in this unit to a wall outlet until all connections are complete.
- 8 Do not operate this unit upside-down. It may overheat, possibly causing damage.
- 9 Do not use force on switches, knobs and/or cords.
- 10 When disconnecting the power cable from the wall outlet, grasp the plug; do not pull the cable.
- 11 Do not clean this unit with chemical solvents; this might damage the finish. Use a clean, dry cloth.
- 12 Only voltage specified on this unit must be used. Using this unit with a higher voltage than specified is dangerous and may cause fire, damage to this unit, and/or personal injury. Yamaha will not be held responsible for any damage resulting from use of this unit with a voltage other than specified.
- 13 To prevent damage by lightning, keep the power cable disconnected from a wall outlet or this unit during a lightning storm.
- 14 Do not attempt to modify or fix this unit. Contact qualified Yamaha service personnel when any service is needed. The cabinet should never be opened for any reasons.
- 15 When not planning to use this unit for long periods of time (i.e. vacation), disconnect the AC power plug from the wall outlet.
- 16 Be sure to read the "TROUBLESHOOTING" section on common operating errors before concluding that this unit is faulty.
- 17 Before moving this unit, press  to set the unit to off, and disconnect the AC power plug from the wall outlet.
- 18 Condensation will form when the surrounding temperature changes suddenly. Disconnect the power cable from the outlet, then leave this unit alone.
- 19 When using this unit for a long time, this unit may become warm. Turn off, then leave this unit alone for cooling.
- 20 Install this unit near the wall outlet and where the AC power plug can be reached easily.
- 21 The batteries shall not be exposed to excessive heat such as sunshine, fire or the like. When you dispose of batteries, follow your regional regulations.
 - Keep the batteries in a location out of reach of children. Batteries can be dangerous if a child were to put in his or her mouth.
 - If the batteries grow old, the effective operation range of the remote control decreases considerably. If this happens, replace the batteries with new one as soon as possible.
 - Do not use old batteries together with new ones.
 - Do not use different types of batteries (such as alkaline and manganese batteries) together. Read the packaging carefully as these different types of batteries may have the same shape and color.
 - Exhausted batteries may leak. If the batteries have leaked, dispose of them immediately. Avoid touching the leaked material or letting it come into contact with clothing, etc. Clean the battery compartment thoroughly before installing new batteries.
 - If you plan not to use the unit for a long period of time, remove the batteries from the unit. Otherwise, the batteries will wear out, possibly resulting in a leakage of battery liquid that may damage the unit.
 - Do not throw away batteries with general house waste. Dispose of them correctly in accordance with your local regulations.
- 22 Excessive sound pressure from earphones and headphones can cause hearing loss.

This unit is not disconnected from the AC power source as long as it is connected to the wall outlet, even if this unit itself is turned off by . In this state, this unit is designed to consume a very small quantity of power.

WARNING
TO REDUCE THE RISK OF FIRE OR ELECTRIC SHOCK, DO NOT EXPOSE THIS UNIT TO RAIN OR MOISTURE.

CAUTION
Danger of explosion if battery is incorrectly replaced. Replace only with the same or equivalent type.

There is a chance that placing this unit too close to a CRT-based (Braun tube) TV set might impair picture color. Should this happen, move this unit away from the TV set.



CONTENTS

NAMES OF PARTS AND THEIR FUNCTIONS	2	Selecting DAB stations.....	12
Front panel.....	2	Presetting DAB stations (remote control only)	13
Front panel display.....	2	Selecting preset DAB stations.....	14
Remote control.....	3	Checking the signal strength of DAB stations (Option menu)	14
CONNECTIONS	4	LISTENING TO FM STATIONS	15
Connecting the speakers and antenna	4	Selecting an FM station.....	15
Connecting the power cable.....	5	Presetting FM stations (remote control only)	16
Other connections.....	5	Selecting preset FM stations.....	17
About the standby state	5	LISTENING TO EXTERNAL SOURCES	17
ADJUSTING THE CLOCK (OPTION MENU)	6	USEFUL FUNCTIONS	18
LISTENING TO CD AND USB DEVICES	7	Using the Option menu	18
Listening to a CD.....	7	Using the sleep timer	19
Listening to a USB device.....	8	Using the alarm function (IntelliAlarm)	19
Using repeat/shuffle playback (remote control only).....	8	Setting the alarm	20
LISTENING TO MUSIC FROM YOUR <i>Bluetooth</i> COMPONENT	9	Operations while the alarm sound is playing.....	21
Playing back from your <i>Bluetooth</i> component.....	9	TROUBLESHOOTING	22
Connecting an already-paired component via <i>Bluetooth</i>	10	NOTES ON DISCS AND USB DEVICES	25
Disconnecting a <i>Bluetooth</i> connection.....	10	SPECIFICATIONS	26
LISTENING TO DAB STATIONS	11		
Preparing for DAB reception	11		

Features

- Play back music from external devices such as your audio/data CDs, USB devices, or external devices via the AUX jack, and listen to the radio.
- Listen to the DAB radio.
- By the *Bluetooth* technology, you can enjoy clear sound without wire connections.
- Use your favorite music or a beep tone as an alarm. When the set time arrives, the music you select is played at the volume that you specify, giving you the ideal start to your day (IntelliAlarm function).
- You can easily store and recall of your favorite radio stations, up to 30 FM and 30 DAB stations.
- Bass, middle, and treble can be adjusted to your taste.

◆ About this manual

- If an operation can be performed using either the buttons on the unit itself or from the remote control, the explanation will focus on operation using the remote control.
-  indicates precautions for use of the unit and its feature limitations.
-  indicates supplementary explanations for better use.

Supplied accessories



Remote control

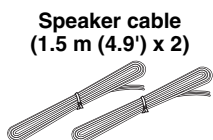

Speaker cable
(1.5 m (4.9') x 2)

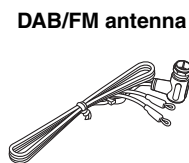

DAB/FM antenna

Batteries (x 2)
(AAA, R03, UM-4)

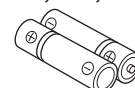

◆ How to use the remote control

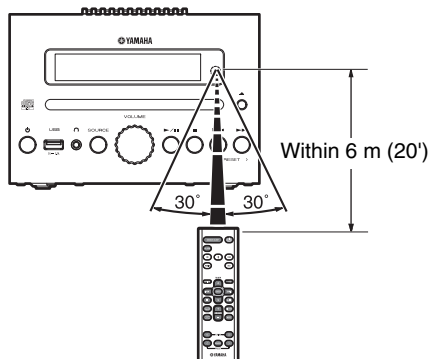

◆ Installing batteries in the remote control

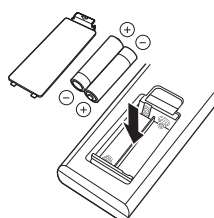

Check the “+” and “-” of the batteries and insert them the correct way around.

NAMES OF PARTS AND THEIR FUNCTIONS

Front panel

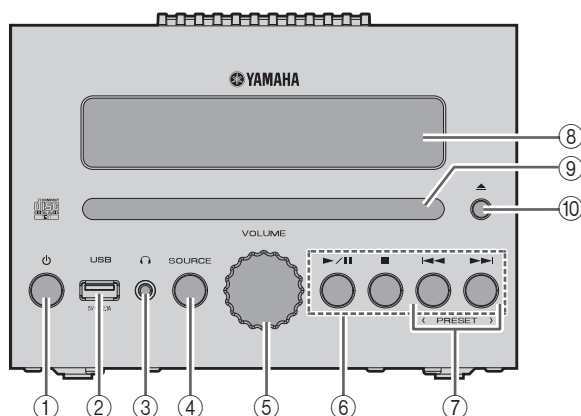

① (Power)

Press to turn the unit on/off (standby).
There are two types of the standby state (☞ P. 5).

② USB port

Connect your USB device here (☞ P. 5, 8).

③ (Headphone jack)

Connect headphones here.

④ SOURCE

Switch the audio source to be played.
Pressing this repeatedly will change the selection in the following order.

CD → USB → DAB → FM → BT → AUX
↑

⑤ VOLUME knob

Adjust the volume.

⑥ Audio control buttons

Use these to operate the CD/USB device.

▶/⏸: Play/Pause

■: Stop

⏮/▶▶: Skip, Search backward/forward (press and hold down)

⑦ PRESET </>

Use these buttons to select a radio station that you've stored (☞ P. 16, 17).

⑧ Front panel display

The clock and other information is displayed here.

⑨ Disc slot

Insert a CD here (☞ P. 7).

⑩ ▲ (Eject button)

Eject the CD (cannot be operated while the option menu (☞ P. 18) is displayed).

Front panel display

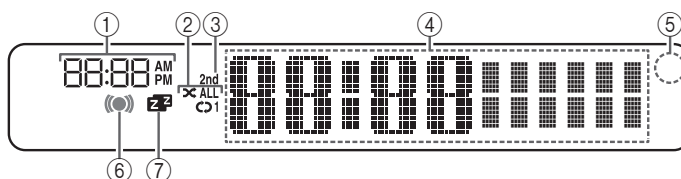

① Alarm time

Indicates the alarm time (☞ P. 20).

② Repeat/shuffle indicator

Displays the playback mode (☞ P. 8).

③ Secondary indicator

Turns on if a secondary station is playing when you listen to a DAB station.

④ Multi-function indicator

Displays various information, including the clock time, information about the currently-playing track, and the frequency of the radio station.

⑤ Remote control signal receiver

Make sure that this sensor is not obstructed (☞ P. 1).

⑥ Alarm indicator

Turns on if the alarm has been set (☞ P. 20).

⑦ Sleep indicator

Turns on if the sleep timer has been set (☞ P. 19).

Remote control

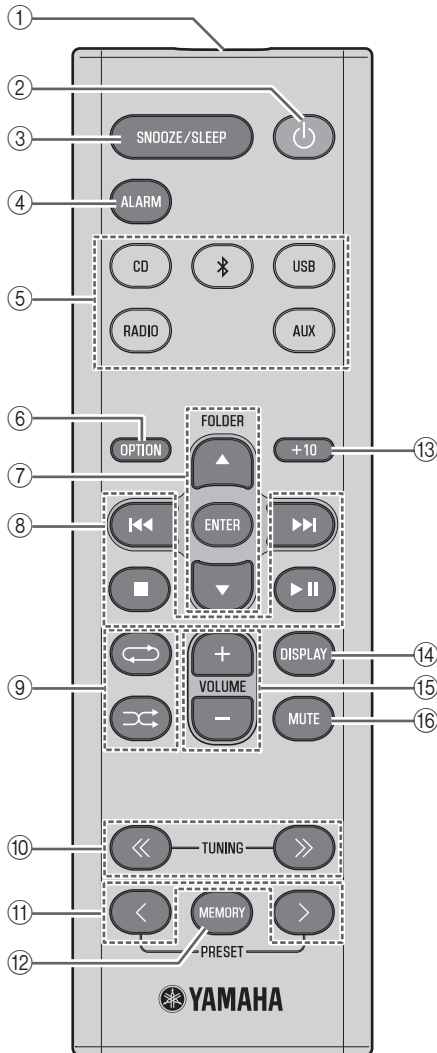

① **Remote control signal transmitter**

② **Power**

Press to turn the unit on/off (standby).

There are two types of the standby state (☞ P. 5).

③ **SNOOZE/SLEEP**

Set the sleep timer or switch the alarm to snooze mode (☞ P. 19, 21).

④ **ALARM**

Switch the alarm on/off (☞ P. 21).

⑤ **Source buttons**

Switch the audio source to be played. If you press one of these while the unit is in standby (except ECO standby), the unit will automatically turn on.

When listening to the radio, press RADIO to switch between DAB/FM.

⑥ **OPTION**

Display the option menu (☞ P. 18).

⑦ **Item selection buttons**

FOLDER ▲/▼: Switch the playback folder and select items or edit numerical values when playing music on data CDs or USB devices.

ENTER: Confirm a selected item or value.

⑧ **Audio control buttons**

Use these to operate the CD/USB device.

■: Stop

▶||: Play/Pause

◀◀/▶▶: Skip, Search backward/forward (press and hold down)

⑨ **Repeat/ Shuffle**

Play music on a CD or USB device in repeat/shuffle mode (☞ P. 8).

⑩ **TUNING </>**

Tune the radio (☞ P. 15, 16).

⑪ **PRESET </>**

Select a radio station that you stored (☞ P. 16, 17).

⑫ **MEMORY**

Store a radio station (☞ P. 16).

⑬ **+10**

Skip ten songs ahead of the currently-playing song.

When playing a data CD or a USB device, this button skips ten songs within the current folder.

⑭ **DISPLAY**

Switch the information shown in the front panel display (☞ P. 7, 8, 15).

⑮ **VOLUME +/-**

Adjust the volume.

⑯ **MUTE**

Mute or unmute the sound.

CONNECTIONS

Connecting the speakers and antenna

Connect the speakers and antenna.

Do not connect this unit's power cable until you've finished connecting all cables.

If the radio reception is poor, try changing the height or direction or placement of the antenna to find a location that has better reception.

If you use a commercially available outdoor antenna instead of the supplied antenna, reception may be better.

◆ Speakers



- You must peel off the insulation (covering) from the tip of the speaker cable to expose the conductor.
- Check the connections; make sure that left and right (L, R) and polarity (red: +, black: -) are connected correctly. If connections are incorrect, the sound will be unnatural and the low frequencies may be insufficient. There might not be any sound at all if connections are incorrect.
- Take care that the conductors of the speaker cable do not touch each other, and that the conductors do not touch any other metal part. Such conditions can damage this unit or the speakers.
- Use only the supplied speakers. Using other speakers may result in unnatural sound.
- If you're using this unit nearby a CRT display and you notice distorted color or noise in the display, move the speakers farther away from the display.

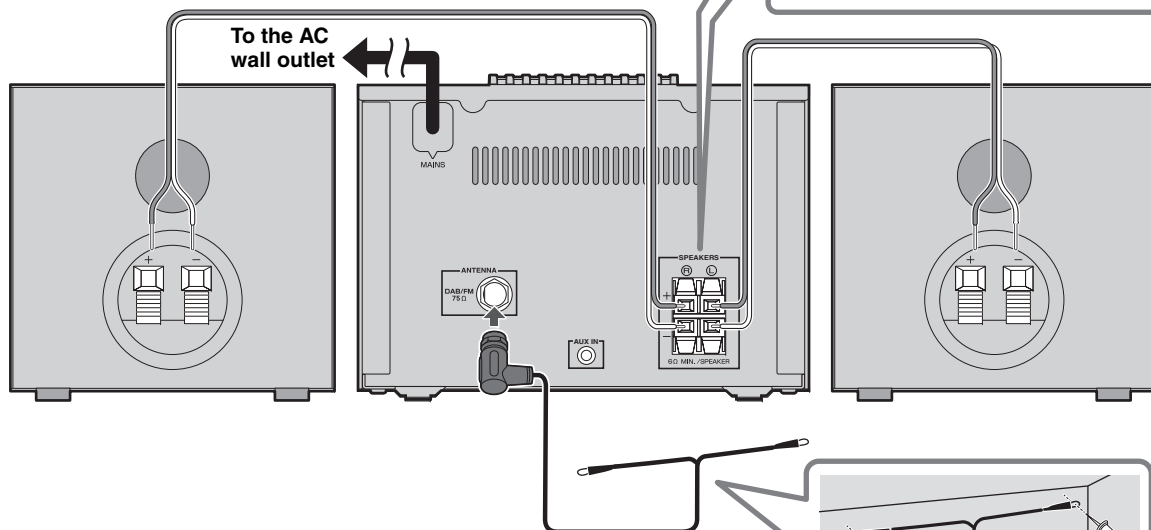
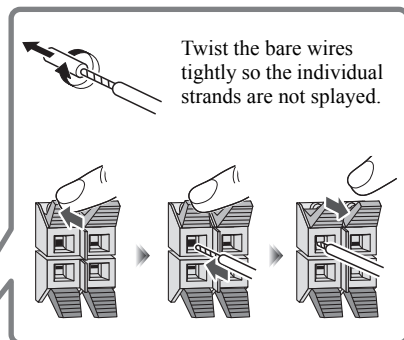

◆ DAB/FM antenna



Be sure to stretch out the antenna.

Connecting the power cable

When you've completed all connections, connect this unit's power cable to an AC outlet.

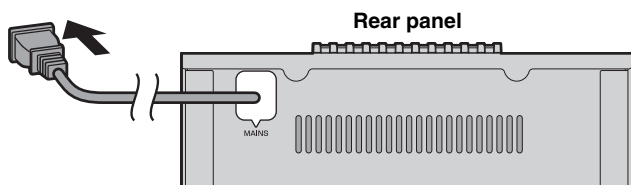

Other connections

◆ USB device

Connect your USB device to the USB port on the front panel. For details on playable files, refer to “NOTES ON DISCS AND USB DEVICES” (P. 25).

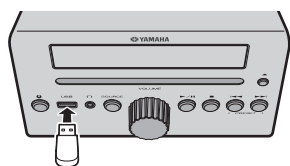

The USB device is automatically charged when this unit is on or in standby.



- Stop playback before disconnecting the USB device.
- Charging may not be possible depending on the USB device.

◆ External devices

Using a commercially available 3.5 mm mini-plug cable, connect your external device to the AUX jack on the rear panel of this unit.

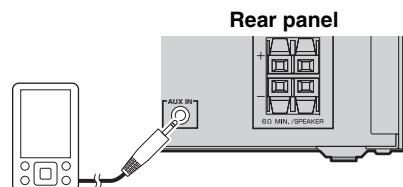

About the standby state

This unit has the following two types of standby state. Select the mode in POWER SAVING settings menu (P. 18).

Mode	Setting menu (POWER SAVING)	Clock display	Bluetooth connection	Charging of USB devices	Alarm setting
ECO standby* (power saving mode)	ECO	No clock display	Disable	Disable	Disable
Standby	NORMAL	Show	Enable	Enable	Enable

* Default setting

ADJUSTING THE CLOCK (OPTION MENU)

You'll use the option menu (see P. 18) to set this unit's date and time.

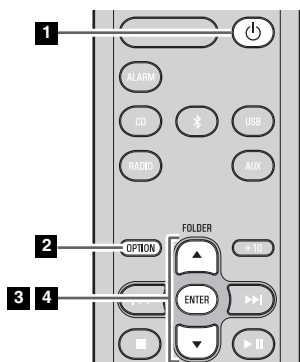

Clock display

Display (24-hour) when the unit is on

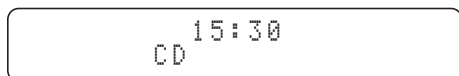

Display (24-hour) when the unit is off (standby)*



Jan	Feb	Mar	Apr	May	Jun
January	February	March	April	May	June
Jul	Aug	Sep	Oct	Nov	Dec
July	August	September	October	November	December

* In ECO standby, the clock display will disappear.

1 Press to turn the unit on.

2 Press **OPTION**.

The option menu will appear.

3 Press **▲/▼** to select "CLOCK SET," and then press **ENTER**.

The display will indicate "CLOCK YEAR," and the numerical value to be set will blink.

4 Set the date and time.

Press **▲/▼** to edit each numerical value, and then press **ENTER** to confirm the setting.

Set the items in the order of year → month → day → hour → minute.

When clock setting has finished, the display will indicate "Completed!"

The clock will be set to 0 second the moment you complete the clock settings.



- While making these settings, you can press **DISPLAY** to select the time format (12-hour / 24-hour).

- If you decide to cancel without changing the setting, press **OPTION** before confirming the change.



The time settings will be reset if the unit remains unpowered for about one hour.

LISTENING TO CD AND USB DEVICES

The unit will operate as follows when playing back tracks/files on CD/USB devices.

- If the CD/USB device being played is stopped, the track that you listened will start playback from the beginning of the track the next time you play.
- If you press **■** while playback is stopped, tracks will play as follows the next time playback begins:
 - **Audio CD:** Play from the first track of the CD.
 - **Data CD*/USB device:** Play from the first track of the folder contains the track you listened to last time.
- This unit automatically turns off (standby) if no operation has been performed for 20 minutes after CD/USB device playback is stopped.

* “Data CD” is a CD that contains MP3/WMA files.



For details on playable discs and files, refer to “NOTES ON DISCS AND USB DEVICES” (P. 25).

Listening to a CD

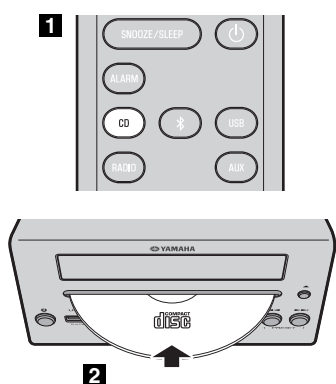

- 1 Press the **CD** source button to switch the audio source to CD.

If a CD is already inserted, playback will start.

- 2 Insert a CD into the disc slot.

Playback starts automatically.

Playback can be controlled with either the remote control, or the front panel on this unit (P. 2, 3).



Insert the CD with the label side facing upward.



Folders and files on a data CD are played in alphabetical order.

◆ Skipping folders (remote control only)

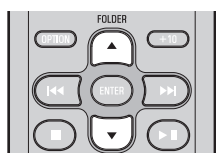

While a data CD is playing, you can use the remote control’s **FOLDER ▲/▼** buttons to select the folder.

◆ Display information (remote control only)

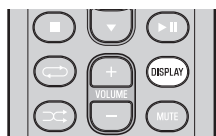

The folder number (only for a data CD) or the song/file number is shown for several seconds when starting playback or skipping tracks.

If you press **DISPLAY** on the remote control while a song is playing or paused, the information shown on the front panel display will be switched in the following order.

- - Elapsed song playback time
- Remaining song playback time (only for an audio CD)
- Song name*
- Album name*
- Artist name*
- File name (only for a data CD)
- Folder name (only for a data CD)

* Shown only if this data is included in the song.

Listening to a USB device

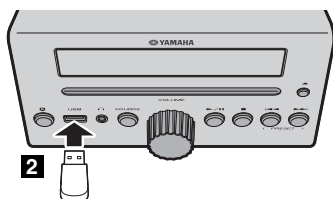
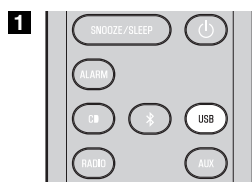

- 1** Press the **USB** source button to switch the audio source to USB.
If a USB device is already connected, playback will start.
- 2** Connect a USB device to the USB port.
Playback starts automatically.
Playback can be controlled with either the remote control, or the front panel on this unit (P. 2, 3).



Folders and files will play in the order in which they were written.



Stop playback before disconnecting the USB device.

◆ Skipping folders (remote control only)

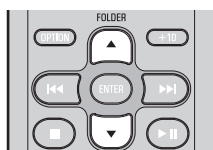

While a USB device is playing, you can use the remote control's **FOLDER ▲/▼** buttons to select the folder.

◆ Display information (remote control only)



The folder/file number is shown for several seconds when starting playback or skipping tracks.

If you press **DISPLAY** on the remote control while a song is playing or paused, the information shown on the front panel display will be switched in the following order.

- - Elapsed song playback time
- Song name*
- Album name*
- Artist name*
- File name
- Folder name

* Shown only if this data is included in the song.

Using repeat/shuffle playback (remote control only)

The playback status is shown by the repeat/shuffle indicator in the front panel display.

◆ Repeat playback



Press (repeat) repeatedly to select one of the following playback modes.

No display: Repeat mode off

1: 1 track

: All tracks within the folder (data CD/USB device only)

ALL
: All tracks

◆ Shuffle playback



Press (shuffle) repeatedly to select one of the following playback modes.

No display: Shuffle mode off

: All tracks within the folder (data CD/USB device only)

ALL: All tracks

LISTENING TO MUSIC FROM YOUR *Bluetooth* COMPONENT

This unit provides *Bluetooth* functionality. You can enjoy wireless music playback from your *Bluetooth* component (mobile phone, digital audio player, etc.). Please also refer to the owner's manual of your *Bluetooth* component.

Playing back from your *Bluetooth* component

You'll need to perform the pairing operation the first time you use your *Bluetooth* component with this unit, or if the pairing settings have been deleted. Pairing is an operation that registers the communicating component (subsequently called "the other component") with this unit. Once pairing has been completed, subsequent reconnection will be easy even after the *Bluetooth* connection is disconnected (☞ P. 10). If pairing is not successful, refer to the item "*Bluetooth*" in "TROUBLESHOOTING" (☞ P. 23).



Yamaha does not guarantee all connections between this unit and *Bluetooth* component.



- This unit can be paired with up to 4 other components. When pairing with the fifth component has succeeded, pairing data for the component with the oldest connection date will be deleted.
- While connecting to the *Bluetooth* component and perform the pairing with another component, the current *Bluetooth* connection will be canceled.

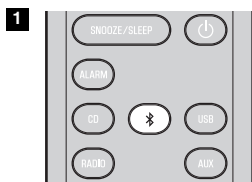

3

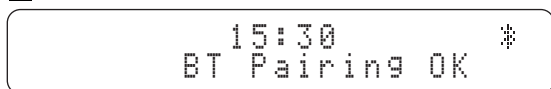

1 Press the  source button for more than 2 seconds to enter pairing mode.

- Pairing mode lasts for 5 minutes.
- In pairing mode, the front panel display of this unit will indicate "BT Pairing...".



You can also enter pairing mode by holding down **SOURCE** on this unit.

2 Perform *Bluetooth* pairing on the other component.

For details refer to the owner's manual of the other component.

3 From the *Bluetooth* connection list of the other component, choose this unit (MCR-B043D Yamaha).

When pairing has been completed, the front panel display of this unit will indicate "BT Pairing OK".



If you are asked to enter a password, enter the numerals "0000".

4 Connect this unit and your other component via *Bluetooth*.

5 Play back music from your *Bluetooth* component.



Take care that the volume setting of this unit is not too high. We recommend that you adjust the volume on the other component.



- If you connect via *Bluetooth* from your other component while this unit is in standby (except ECO standby), this unit will automatically turn on.
- If you disconnect the *Bluetooth* connection from your other component while the audio source is set to *Bluetooth*, this unit will automatically turn off (standby).
- If *Bluetooth* is selected as the audio source, this unit will automatically turn off (standby) when 20 minutes have elapsed without any *Bluetooth* connection nor any operation performed.

Connecting an already-paired component via *Bluetooth*

Once pairing has been completed, connecting a *Bluetooth* will be easy the next time.

◆ Connecting from this unit

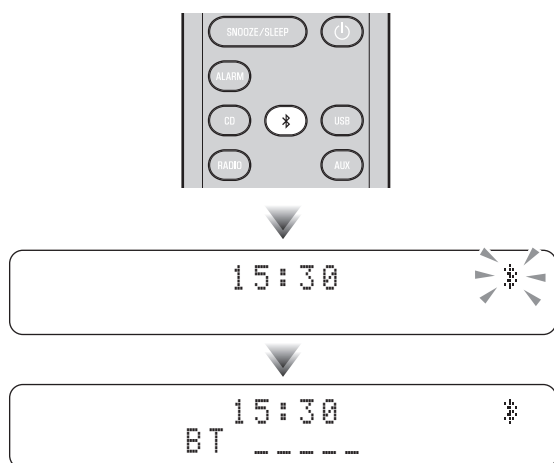

Press the source button to switch the audio source to *Bluetooth*.

The *Bluetooth* indicator will blink in the front panel display; this unit will search for the other component that was most recently connected via *Bluetooth*, and will then establish a connection (You must first turn on the *Bluetooth* setting of the other component).

When the *Bluetooth* connection has been established, the *Bluetooth* indicator will light, and the name of the other component will be displayed.

◆ Connecting from the other component

1 In the *Bluetooth* settings of the other component, turn *Bluetooth* on.

2 From the *Bluetooth* connection list of the other component, choose this unit (MCR-B043D Yamaha).
The *Bluetooth* connection will be established, and the front panel display of this unit will indicate the name of the other component.



Bluetooth connections cannot be established from the other component when this unit is in ECO standby (P. 5).

Disconnecting a *Bluetooth* connection

If any of the following operations are performed while a *Bluetooth* connection is being used, the *Bluetooth* connection will be disconnected.

- Switch the audio source other than *Bluetooth*.
- Turn the unit off.
- Turn off the *Bluetooth* setting of the other component.

LISTENING TO DAB STATIONS

DAB (Digital Audio Broadcasting) and DAB+ use digital signals for clearer sound and more stable reception compared to analog signals.

DAB+ is based on the original DAB standard but uses a more efficient audio codec.

DAB and DAB+ are broadcast in blocks of data called “ensembles” containing up to several radio stations that are simultaneously broadcast.

DAB and DAB+ can also include an extensive amount of text information, enabling you to select a station by name.

Other information, such as the ensemble name or the status of the digital signal, can be displayed on the front panel display.

“DAB” described in this manual may also refer to “DAB+”.

Preparing for DAB reception

Before tuning into DAB stations, an initial scan must be performed. When you select the DAB for the first time, the initial scan is performed automatically.

To listen to a DAB station, connect the antenna as described in “Connecting the speakers and antenna” (P. 4).



Press the **RADIO** source button to switch the audio source to DAB.

The initial scan starts. During the scan, the degree of progress is displayed on the front panel display.

When scan is completed, the number of receivable DAB stations appear on the front panel display.



If the initial scan is performed, stored DAB station information and preset DAB stations are cleared.

◆ Performing the initial scan again (Option menu)

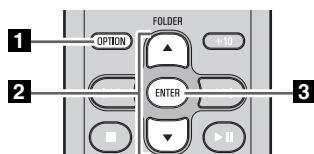

1 Press **OPTION**.

The option menu will appear.

2 Press **▲/▼** to select DAB INIT SCAN, and then press **ENTER**.

The display will indicate “Press ENTER”.

3 Press **ENTER**.

The initial scan starts.

Selecting DAB stations

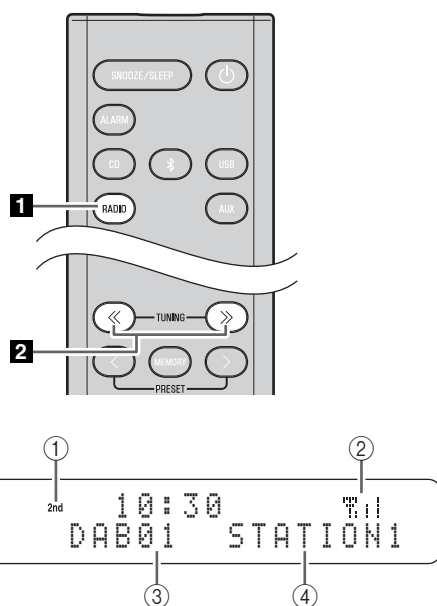

1 Press the **RADIO** source button to switch the audio source to DAB.

2 Press **TUNING <</>** to select the DAB station.

While receiving DAB, DAB station information is shown on the front panel display.

If the unit does not receive a DAB signal, “Off Air” is displayed instead of the DAB station name.

① **Secondary indicator:**

Some stations have sub (secondary) stations.

If a secondary station is playing, the secondary indicator is displayed.

② **Signal strength indicator:**

Shows current signal strength.

③ **Preset number**

④ **DAB station name**

◆ Display information (remote control only)

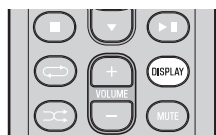

If you press **DISPLAY** on the remote control, the information shown on the front panel display will be switched in the following order.

- STATION LABEL, PRESET NUMBER
- DLS (Dynamic Label Segment)
- ENSEMBLE LABEL
- CHANNEL/FREQ (Channel label and frequency)
- SIGNAL QUALITY
- AUDIO FORMAT (Audio format, DRC)

◆ DAB frequency information

This unit can receive Band III only.

Frequency	Channel label
174.928	5A
176.640	5B
178.352	5C
180.064	5D
181.936	6A
183.648	6B
185.360	6C
187.072	6D
188.928	7A
190.640	7B
192.352	7C
194.064	7D
195.936	8A

Frequency	Channel label
197.648	8B
199.360	8C
201.072	8D
202.928	9A
204.640	9B
206.352	9C
208.064	9D
209.936	10A
211.648	10B
213.360	10C
215.072	10D
216.928	11A
218.640	11B

Frequency	Channel label
220.352	11C
222.064	11D
223.936	12A
225.648	12B
227.360	12C
229.072	12D
230.784	13A
232.496	13B
234.208	13C
235.776	13D
237.488	13E
239.200	13F

Presetting DAB stations (remote control only)

Use the preset function to store your favorite 30 stations.

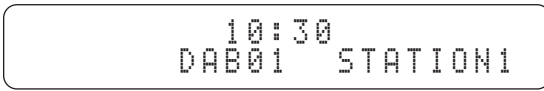
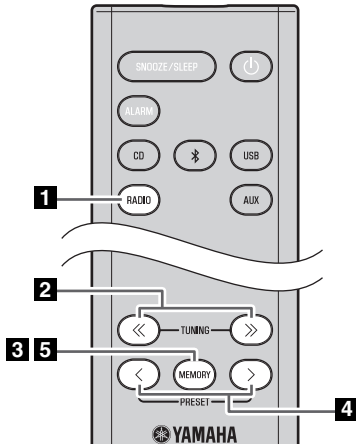

◆ Deleting a stored preset (Option menu)

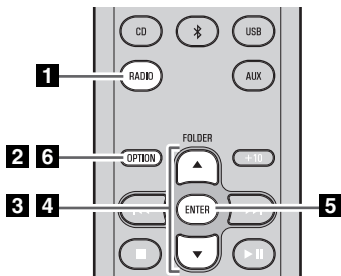

- 1** Press the **RADIO** source button to switch the audio source to DAB.
- 2** Press **TUNING** <</> to select a station that you want to preset.
- 3** Press **MEMORY**.
The display will indicate “PRESET MEMORY,” and the preset number will blink.
- 4** Press **PRESET** </> to select the preset number that you want to store.
 -  The lowest preset number that has not been stored will be selected first.
 - If you want to cancel the presetting, press **■**.
 - If you select a preset number in which a station has already been stored, it will be overwritten by the new station.
- 5** Press **MEMORY**.
This stores the DAB station.
When presetting has finished, the display will indicate “Completed!”.

- 1** Press the **RADIO** source button to switch the audio source to DAB.
- 2** Press **OPTION**.
The option menu will appear.
- 3** Press **▲/▼** to select PRESET DELETE, and then press **ENTER**.
- 4** Press **▲/▼** to select the preset number that you want to delete.
 -  If you want to cancel the deleting, press **OPTION**.
- 5** Press **ENTER** to complete the operation.
When deleting has finished, the display will indicate “Deleted!”.
- 6** Press **OPTION** to exit the option menu.

Selecting preset DAB stations

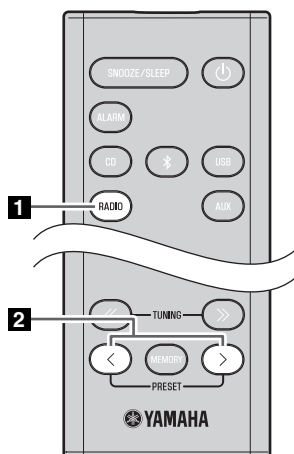

1 Press the **RADIO** source button to switch the audio source to DAB.

2 Press **PRESET </>** to select the DAB station that you want to hear.



You can only select presets that have been stored.

Checking the signal strength of DAB stations (Option menu)

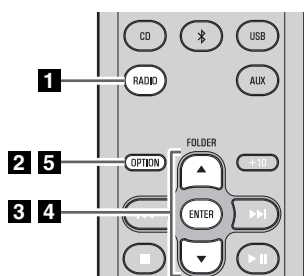

1 Press the **RADIO** source button to switch the audio source to DAB.

2 Press **OPTION**.

The option menu will appear.

3 Press **▲/▼** to select TUNE AID, and then press **ENTER**.

4 Press **▲/▼** to select the DAB station.

The signal strength will appear.

5 Press **OPTION** to exit the option menu.

LISTENING TO FM STATIONS

Selecting an FM station

To listen to the FM station, connect the antenna as described in “Connecting the speakers and antenna” (P. 4).

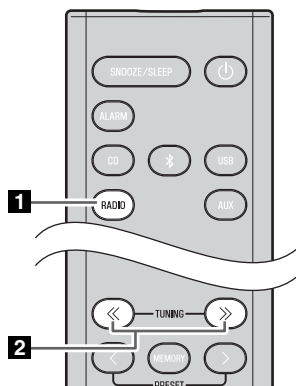

1 Press the **RADIO** source button to switch the audio source to FM.

2 Tune FM stations

Automatic tuning: Press and hold **TUNING** << / >>.

Manual tuning: Press **TUNING** << / >> repeatedly.



If you tune to a station manually while receiving FM, the sound will be monaural.

◆ Display information (remote control only)

If you press **DISPLAY** on the remote control, the information shown on the front panel display will be switched in the following order.

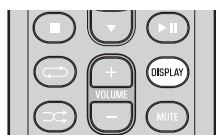

Preset number and frequency ↔ **Reception status***

* Example of reception status indication.

TUNED/STEREO: A strong FM stereo broadcast is being received.

TUNED/MONO: A monaural FM broadcast is being received (even if the FM broadcast is stereo, reception will be monaural if the signal is weak).

Not TUNED: No broadcast is being received.

Displaying Radio Data System information

If you press **DISPLAY** on the remote control while Radio Data System information is being received, the information shown on the front panel display will be switched in the following order.

- PS (Program Service)
- PTY (Program Type)
- RT (Radio Text)
- CT (Clock Time)
- Reception status
- Preset number and frequency



If the signal transmission of the Radio Data System station is too weak, this unit may not be able to receive Radio Data System information completely. In particular, RT (Radio Text) information uses a lot of bandwidth, so it may be less available compared to other types of information.

Presetting FM stations (remote control only)

Use the preset function to store your favorite 30 stations.

First, press the **RADIO** source button to switch the audio source to FM.

◆ Auto preset

This method tunes automatically, and automatically presets only the stations that have good reception.

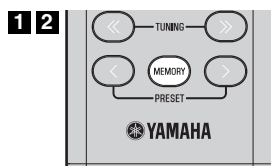

1 Press and hold down **MEMORY**.

“AUTO PRESET” will appear and “Press MEMORY” will blink.

2 Press **MEMORY**.

Auto preset will begin.

When presetting has finished, the display will indicate “Completed!”.



When you perform auto preset, all stored stations are cleared and the new stations are stored.



If you want to stop auto preset before it is completed, press ■.

◆ Manual preset

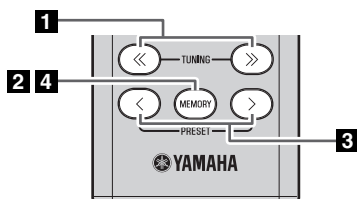

1 Press **TUNING** << / >> to tune a station that you want to preset.

2 Press **MEMORY**.

The display will indicate “PRESET MEMORY,” and the preset number will blink.

3 Press **PRESET** </> to select the preset number that you want to store.



- The lowest preset number that has not been stored will be selected first.
- If you want to cancel the presetting, press ■.
- If you select a preset number in which a station has already been stored, it will be overwritten by the new station.

4 Press **MEMORY**.

When presetting has finished, the display will indicate “Completed!”.

◆ Deleting a stored preset (Option menu)

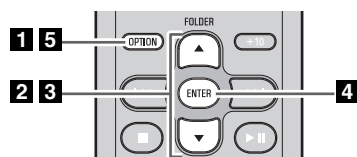

1 Press **OPTION**.

The option menu will appear.

2 Press ▲/▼ to select **PRESET DELETE**, and then press **ENTER**.

3 Press ▲/▼ to select the preset number that you want to delete.



If you want to cancel the deleting, press **OPTION**.

4 Press **ENTER** to complete the operation.

When deleting has finished, the display will indicate “Deleted!”.

5 Press **OPTION** to exit the option menu.

Selecting preset FM stations

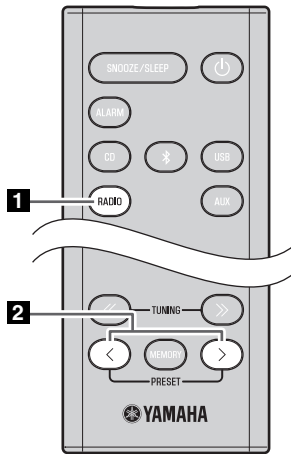

1 Press the **RADIO** source button to switch the audio source to FM.

2 Press **PRESET </>** to select the FM station that you want to hear.



You can only select presets that have been stored.

LISTENING TO EXTERNAL SOURCES

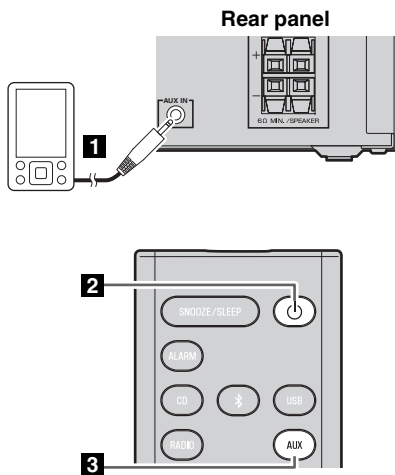

1 Using a commercially available 3.5 mm mini-plug cable, connect your external device to the **AUX** jack on the rear panel of this unit.



- Turn the unit off before connecting the audio cable.
- Turn down the volume of the unit and your external audio device before connection.

2 Press **⏻** to turn the unit on.

3 Press the **AUX** source button to switch the audio source to AUX.

4 Start playback on the connected external audio device.

USEFUL FUNCTIONS

Using the Option menu

When you press **OPTION**, the option menu will appear in the front panel display, allowing you to make the following settings.



▲ (eject button) cannot be operated while the option menu is displayed.

Option menu	Setting or range	See page
PRESET DELETE	Deletes a stored preset (shown only if the audio source is DAB/FM).	13, 16
DAB INIT SCAN	Performs the initial scan (shown only if the audio source is DAB).	11
DAB TUNE AID	Checks the signal strength of DAB station (shown only if the audio source is DAB).	14
DIMMER	Adjusts the brightness of the front panel display (1* : bright, 2 : medium, 3 : dim).	–
EQ LOW	Adjusts the tonal character (low frequencies) (-10 - 0* - +10 dB).	–
EQ MID	Adjusts the tonal character (mid frequencies) (-10 - 0* - +10 dB).	–
EQ HIGH	Adjusts the tonal character (high frequencies) (-10 - 0* - +10 dB).	–
BALANCE	Adjusts the volume balance of the left and right speakers (L+10 - CENTER* - R+10).	–
POWER SAVING	Switches the standby state, NORMAL or ECO (power saving mode)	5
AUTO PWR STDBY	You can specify the time after which the unit will turn off (standby) automatically. If no operation occurs for the duration you specify, the unit will turn off (standby) automatically (TIME 12H : 12 hours, TIME 8H* : 8 hours, TIME 4H : 4 hours, TIME 2H : 2 hours, OFF : the unit will not turn off (standby)).	–
CLOCK SET	Sets the date and time.	6
ALARM SET	Sets the alarm.	20
BLUETOOTH	Connects this unit and your component via <i>Bluetooth</i> (ON* : enable, OFF : disable).	9

* Default setting

◆ Procedure for settings

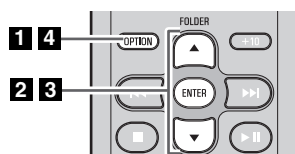

1 Press **OPTION**.

The option menu will appear.

2 Press ▲/▼ to select the menu item that you want to set, and then press **ENTER**.

3 Press ▲/▼ to edit the setting, and then press **ENTER** to confirm the setting.

If you want to continue making other settings, repeat the procedure from step **2**.

4 Press **OPTION** to exit the option menu.



If you decide to cancel without changing the setting, press **OPTION** before confirming the change.

Using the sleep timer

When the specified time has elapsed, the unit will turn off automatically.



Press **SNOOZE/SLEEP** repeatedly to specify the time after which the unit will turn off.

You can specify 30, 60, 90, 120 or OFF.

When you select a time, the sleep timer is turned on, and the sleep indicator (Z Z) is shown in the front panel display.



If you press **SNOOZE/SLEEP** while the sleep timer is activated, the sleep timer setting will be canceled.

Using the alarm function (IntelliAlarm)

The unit includes an alarm function that plays back audio sources or a set of beep (internal alarm sound) at the set time using a variety of different methods. The alarm function has the following features.

◆ 3 types of alarms

Select from 3 alarm types, combining music and beep sounds.

SOURCE+BEEP	The selected audio source and the beep sound are played at the set time. Source playback begins to fade in 3 minutes before the set time and the volume gradually increases to the set volume. Then, at the set time, the beep sound is activated.
SOURCE	The selected audio source is played at the set time. The volume fades in gradually and increases to the set volume.
BEEP	The beep sound is played at the set time.

◆ Various audio sources

You can choose from audio CD, data CD, USB device, or DAB/FM. The following playback methods can also be selected depending on the audio source:

Source	Playback method	Function
Audio CD	Selected track	The selected track is played repeatedly.
	Resume	The track you listened to last time is played back.
Data CD/USB device	Folder	The selected folder is played repeatedly.
	Resume	The track you listened to last time is played back.
DAB/FM	Preset station	The selected preset station is played.
	Resume	The DAB/FM station you listened to last time is played back.



You can not choose *Bluetooth* and *AUX* as the audio source.

◆ Snooze

The snooze function can be enabled to replay the alarm after 5 minutes (☞ P. 21).

Setting the alarm

◆ Setting the alarm time and alarm type (Option menu)



The alarm will not function when the unit is in ECO standby. To use the alarm function, set the Option menu item POWER SAVING to NORMAL (P. 18).

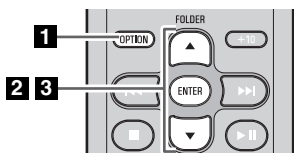

4

Alarm time

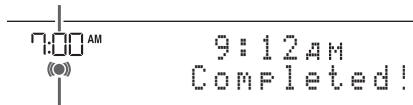

Alarm indicator

1 Press **OPTION**.

The option menu will appear.

2 Press **▲/▼** to select “ALARM SET”, and then press **ENTER**.

The alarm indicator ((●)) and numerical value you're setting will blink.

3 Set the alarm.

Set items ①-④ described below.

Press **▲/▼** to select a numerical value, and press **ENTER** to confirm it.

Items	Setting or range
① ALARM TIME	Make settings in the order of hours → minutes.
② ALARM TYPE	Select from SOURCE+BEEP, SOURCE or BEEP. For details, refer to “3 types of alarms” (P. 19). If you selected BEEP, proceed to item ④.
③ ALARM SOURCE (If you selected SOURCE+BEEP or SOURCE as the alarm type)	CD: Play back music from a CD. Specify the track number (data CD: folder number) (RESUME*, 1-99). USB: Play back music from a USB device. Specify the folder number (RESUME, 1-999). DAB/FM: Play a DAB/FM station. Specify the preset number (RESUME, 1-30). If the selected source cannot be played back at the time set for the alarm, the beep sound is played back.
④ ALARM VOLUME	Specifies the volume (5-60) of the alarm.

* If you choose RESUME when specifying the track/folder/preset number, the last-played track/folder/station will be played (resume playback)

4 Complete the settings.

When you set the VOLUME for item ④, the display will indicate “Completed!” and your settings will be confirmed.

The alarm will be turned on and the alarm indicator ((●)) will light.



If you press **OPTION** or turn the unit off while making alarm settings, the settings will be cancelled.

◆ Switching the alarm on/off



Press **ALARM** to turn the alarm on/off.

When the alarm is on, the alarm indicator (**((●))**) will light, and the alarm time will be shown.

If you press **ALARM** again, the alarm indicator (**((●))**) and the alarm will turn off.



If the Option menu item POWER SAVING is set to ECO, **the alarm will not function** (P. 18).

Operations while the alarm sound is playing

When the set time arrives, the selected alarm sound will play. During playback, the following operations are available.

◆ To pause the alarm (Snooze)



Press **SNOOZE/SLEEP**.

Snooze will stop the alarm and play it again 5 minutes later.



- If SOURCE + BEEP is set as the alarm type, you can press **SNOOZE/SLEEP** once to stop the beep sound, and twice to stop the audio source. 5 minutes after the audio source is stopped, it will start fading in again and the beep sound will resume.
- Buttons on the unit other than the **⏻** will also function as the snooze button.

◆ To turn the alarm off



Press **ALARM** or **⏻**.



- You can also stop the alarm by holding down **SNOOZE/SLEEP**.
- If you don't stop the alarm, it will stop automatically after 60 minutes and the unit will turn off.
- The alarm setting will be saved even if the alarm is turned off. If the alarm is turned on again by pressing **ALARM**, the alarm will sound with the previous alarm settings.

TROUBLESHOOTING

If there is a problem with the unit, check the following list first. If you cannot resolve the problem with the suggested solutions or if the problem is not listed below, turn off and unplug the unit, and consult the nearest authorized Yamaha dealer or service center.

General

Problem	Cause	Solution
The speakers make no sound.	The volume might be set to the minimum level, or muted.	Adjust the volume level.
	The source may be incorrect.	Select the correct source.
	The speakers may not be connected securely.	Check the connections (☞ P. 4).
	Headphones are connected.	Remove the headphones.
	The volume of a connected external device is not loud enough.	Raise the volume of the external device.
Sound suddenly turns off.	The sleep timer may be set (☞ P. 19).	Turn the unit on and play the source again.
	The auto power standby function may have operated.	When the time specified for AUTO PWR STDBY in the option menu has elapsed (☞ P. 18) or when 20 minutes have elapsed without any operation being performed after stopping USB device or CD playback, the unit will turn off automatically.
Sound is cracked/distorted or there is abnormal noise.	Input source volume is excessive, or volume of this unit is excessive (especially Bass).	Adjust volume with VOLUME, or use the option menu (☞ P. 18) to adjust the bass range. If an external device is playing back, lower the volume of the external device.
The unit does not operate properly.	The unit may have received a strong electrical shock such as lightning or excessive static electricity, or power supply may have dropped.	Restart the unit by holding down the  for about 10 seconds.
The unit turns on but immediately shuts off.		
A digital or high-frequency equipment produces noises.	The unit may be placed too close to the digital or high-frequency equipment.	Place the unit farther away from the equipment.
The clock setting has been cleared.	The unit remained unpowered for about one hour.	Plug the power cable into the wall outlet firmly, and set the clock again (☞ P. 6).
Alarm does not sound.	The unit is set to ECO standby.	In the option menu, set POWER SAVING to NORMAL (☞ P. 18).
The front panel display indicates “ALARM not work” and can’t set the alarm.		
The unit turns off unexpectedly.	The auto power standby function may have operated.	When the time specified for AUTO PWR STDBY in the option menu has elapsed (☞ P. 18) or when 20 minutes have elapsed without any operation being performed after stopping USB device or CD playback, the unit will turn off automatically.

CD playback

Problem	Cause	Solution
Disc cannot be inserted.	Another disc is already inserted.	Unload the disc with  .
	You are attempting to insert a disc that cannot be used by this unit.	Use a disc supported by the unit (☞ P. 25).
Some button operations do not work.	The disc loaded into the unit may not be compatible.	Use a disc supported by the unit (☞ P. 25).
Playback does not start immediately after pressing ►II (stops immediately).	The disc may be dirty.	Wipe the disc clean (☞ P. 25).
	The disc loaded into the unit may not be compatible.	Use a disc supported by the unit (☞ P. 25).
	If the unit was moved from a cold to warm place, condensation may have formed on the disc reading lens.	Wait for an hour or two until the unit adjusts to the room temperature, and try again.
The front panel display indicates “no operation”, and a disc cannot be inserted or unloaded.	The option menu is displayed. Alternatively, the alarm is playing.	Press OPTION to exit the option menu. Alternatively, press ALARM to stop the alarm.

Problem	Cause	Solution
When you insert a disc, the front panel display indicates “CD No Disc” or “CD Unknown.”	The disc loaded into the unit may not be compatible.	Use a disc supported by the unit (☞ P. 25).
	The disc may be dirty, or a foreign object may have adhered to it.	Wipe the disc clean. Alternatively, remove any foreign object that has adhered to the disc (☞ P. 25).
	The disc does not contain playable files.	Use a disc contains playable files (☞ P. 25).
	The disc was inserted upside down.	Insert the disc with the label facing upward.

USB device playback

Problem	Cause	Solution
MP3/WMA file in the USB device does not play.	The USB device is not recognized.	Turn the unit off and reconnect the USB device to the unit. If the solutions above do not resolve the problem, the USB device is not playable on the unit (☞ P. 25).
	The USB device does not contain playable files.	Use a USB device contains playable files (☞ P. 25).
When you connect a USB device, the front panel display indicates “USB OverCurrent,” and then the front panel display goes blank.	An incompatible USB device was connected to the unit. Alternatively, the USB device is not connect firmly to the unit.	Turn the unit off and reconnect the USB device to the unit. If it does not resolve the problem, the USB device is not playable on the unit (☞ P. 25).

Bluetooth

Problem	Cause	Solution
Cannot make this unit paired with the other component.	The other component does not support A2DP.	Perform pairing operations with a component which supports A2DP.
	A <i>Bluetooth</i> adaptor, etc. that you want to pair with this unit has a password other than “0000”.	Use a <i>Bluetooth</i> adaptor, etc. whose password is “0000”.
	This unit and the other component are too far apart.	Move the other component closer to this unit.
	There is a device (microwave oven, wireless LAN, etc.) outputs signals in the 2.4 GHz frequency band nearby.	Move this unit away from the device that is emitting radio-frequency signals.
	In the option menu, BLUETOOTH is set to OFF .	In the option menu, set BLUETOOTH to ON (☞ P. 18).
Can’t establish a <i>Bluetooth</i> connection.	This unit is not registered on the other component’s <i>Bluetooth</i> connection list.	Perform pairing operations again (☞ P. 9).
	In the option menu, BLUETOOTH is set to OFF .	In the option menu, set BLUETOOTH to ON (☞ P. 18).
No sound is produced or the sound is interrupted during playback.	The <i>Bluetooth</i> connection of this unit with the other component is disconnected.	Perform <i>Bluetooth</i> connection operations again (☞ P. 10).
	This unit and the other component are too far apart.	Move the other component closer to this unit.
	There is a device (microwave oven, wireless LAN, etc.) outputs signals in the 2.4 GHz frequency band nearby.	Move this unit away from the device that is emitting radio-frequency signals.
	The other component’s <i>Bluetooth</i> function is off.	Turn on the <i>Bluetooth</i> function of the other component.
	The other component is not set to send <i>Bluetooth</i> audio signals to this unit.	Check that the <i>Bluetooth</i> function of the other component is set properly.
	The pairing setting of the other component is not set to this unit.	Set the pairing setting of the other component to this unit.
	The other component’s volume is set to the minimum.	Increase the volume level.

DAB reception

Problem	Cause	Solution
Cannot tune into any DAB stations.	The initial scan operations were not performed.	Perform the initial scan operations (☞ P. 11).
	There is no DAB coverage in your area.	Check with your dealer or WorldDMB Online at "http://www.worlddab.org" for a listing of the DAB coverage in your area.
	The DAB signals are too weak.	Change the height, direction, or placement of the antenna.
The initial scan operations are not successful and "Not Found" appears on the front panel display.	The DAB signals are too weak.	Check with your dealer or WorldDMB Online at "http://www.worlddab.org" for a listing of the DAB coverage in your area.
	There is no DAB coverage in your area.	
The DAB station reception is weak.	The DAB signals are too weak.	Change the height, direction, or placement of the antenna.
There is noise interference (e.g. hiss, crackle, or jitter).	The antenna needs to be repositioned.	
	The DAB signals are too weak.	
The DAB station information does not appear or is inaccurate.	The DAB station may be temporarily out of service, or the DAB station information is not provided by the DAB broadcaster.	Contact the DAB broadcaster.

FM reception

Problem	Cause	Solution
Too much noise.	The antenna may be connected improperly.	Make sure the antenna is connected properly (☞ P. 4) or use a commercially available outdoor antenna.
	The antenna is too close to the unit or to an electronic device.	Position the antenna as far away as possible from the unit or the electronic device.
Too much noise during stereo broadcast.	The radio station you selected may be far from your area, or the radio wave reception is weak in your area.	Try manual tuning to improve the signal quality (☞ P. 15) or use a commercially available outdoor antenna.
Even with an outdoor antenna, radio wave reception is weak. (Sound is distorted.)	Multipath reflection or other radio interferences may have occurred.	Change the height, direction, or placement of the antenna (☞ P. 4).

Remote control

Problem	Cause	Solution
The remote control does not work properly.	The remote control may be operated outside its operation range.	For information on the remote control operation range, refer to "How to use the remote control" (☞ P. 1).
	The remote control signal receiver on the unit (☞ P. 2) may be exposed to direct sunlight or lighting (inverted fluorescent lamps).	Change the lighting or orientation of the unit.
	The battery may be worn out.	Replace the battery with a new one (☞ P. 1).
	There are obstacles between the remote control signal receiver on the unit (☞ P. 2) and the remote control.	Remove the obstacles.

NOTES ON DISCS AND USB DEVICES

CD information

This unit is designed for use with audio CD, CD-R*, and CD-RW* with the logos followings.



* ISO 9660 format CD-R/RW



This unit can play back discs bearing any of the logo marks above. A disc logo mark is printed on the disc and the disc jacket.



- Do not load any other type of disc into this unit. Doing so may damage this unit.
- CD-R/RW cannot be played back unless finalized.
- Some discs cannot be played back depending on the disc characteristics or recording conditions.
- Do not use any non-standard shaped discs such as a heart-shaped disc.
- Do not use discs with many scratches on their surface.
- Do not load a cracked, warped, or glued disc.
- Do not use 8-cm discs.

Handling a disc

- Do not touch the surface of the disc. Hold a disc by its edge (and the center hole).
- Do not use a pencil or pointed marker to write on the disc.
- Do not put a tape, seal, glue, etc., on a disc.
- Do not use a protective cover to prevent scratches.
- Do not load more than one disc into this unit at one time. This can cause damage to both this unit and the discs.
- Do not insert any foreign objects into the disc slot.
- Do not expose a disc to direct sunlight, high temperature, high humidity, or a lot of dust.

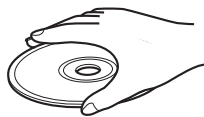

Caution

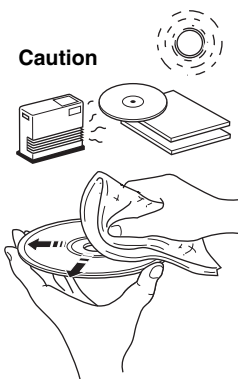

- If a disc becomes dirty, wipe it with a clean, dry cloth from the center out to the edge. Do not use record cleaner or paint thinner.
- To avoid malfunction, do not use a commercially available lens cleaner.

USB device information

This unit supports USB mass storage class devices (e.g., flash memories or portable audio players) using FAT16 or FAT32 format.



- Some devices may not work properly even if they meet the requirements.
- Do not connect devices other than USB mass storage class devices (such as USB chargers or USB hubs), PCs, card readers, an external HDD, etc.
- Yamaha will not be held responsible for any damage to or data loss on the USB device occurring while the device is connected to this unit.
- Playability of and power supply to all kind of USB devices are not guaranteed.
- USB devices with encryption cannot be used.

About MP3 or WMA files



- The unit can play back:

File	Bitrate (kbps)	Sampling frequency (kHz)
MP3	8-320**	16-48
WMA	16-320**	22.05-48

** Both constant and variable bitrates are supported.

- The maximum numbers of files/folders that can be played on the unit are as follows.

	Data CD	USB
Maximum total number of file	512	9999
Maximum folder number	255	999
Maximum file number per folder	511	255

- Copyright-protected files cannot be played back.

SPECIFICATIONS

◆ PLAYER SECTION

CD

- Media CD, CD-R/RW
- Audio format Audio CD, MP3, WMA

USB

- Audio format MP3, WMA

AUX

- Input connector 3.5 mm (1/8 ") STEREO mini jack

◆ Bluetooth SECTION

- *Bluetooth* version Ver. 3.0
- Supported profile A2DP, AVRCP
- Supported codecs SBC
- Wireless output *Bluetooth* Class 2
- Maximum communication distance 10 m (without obstructions)

◆ AMPLIFIER SECTION

- Maximum output power 15 W + 15 W (6 Ω 1 kHz, 10 % THD)
- Headphones 3.5 mm (1/8 in) STEREO mini jack (Impedance 16 to 32 Ω)
- Equalizer characteristics
EQ Low (Bass)/EQ Mid (Middle)/EQ High (Treble) ±10 dB

◆ TUNER SECTION

Tuning range

- DAB/DAB+ 174 to 240 MHz (Band III)
- FM 87.50 to 108.00 MHz

◆ SPEAKER SECTION

- Type Full range bass reflex non magnetic shielding type
- Driver 11 cm (4-1/2") cone type ×1
- Frequency response 50 to 20 kHz (−10 dB)
- Dimensions (W × H × D) 129 (5-1/8") × 126 (4") × 251 (9-7/8") mm
- Weight 1.5 kg (3.3 lbs.)

◆ GENERAL

- Power supply
[U.K. model] AC 230 V, 50 Hz
[Australia model] AC 240 V, 50 Hz
- Power consumption 30 W
- Standby consumption 3.5 W or less (NORMAL)/0.5 W or less (ECO)
- Dimensions (W × H × D) 180 (7-1/8") × 130 (5-1/8") × 281 (11") mm
- Weight 2.6 kg (5.7 lbs.)

Specifications are subject to change without notice.

LASER SAFETY

This unit employs a laser. Due to possible eye injury, only a qualified service person should remove the cover or attempt to service this device.

DANGER

This unit emits visible laser radiation when open. Avoid direct eye exposure to beam. When this unit is plugged into the wall outlet, do not place your eyes close to the opening of the disc slot and other openings to look into inside.

Bluetooth

- *Bluetooth* is a technology for wireless communication between devices within an area of about 10 meters (33 ft) employing the 2.4 GHz frequency band, a band which can be used without a license.
- *Bluetooth* is a registered trademark of the *Bluetooth* SIG and is used by Yamaha in accordance with a license agreement.

Handling *Bluetooth* communications

- The 2.4 GHz band used by *Bluetooth* compatible devices is a radio band shared by many types of equipment. While *Bluetooth* compatible devices use a technology minimizing the influence of other components using the same radio band, such influence may reduce the speed or distance of communications and in some cases interrupt communications.
- The speed of signal transfer and the distance at which communication is possible differs according to the distance between the communicating devices, the presence of obstacles, radio wave conditions and the type of equipment.
- Yamaha does not guarantee all wireless connections between this unit and devices compatible with *Bluetooth* function.

Information for Users on Collection and Disposal of Old Equipment and Used Batteries



These symbols on the products, packaging, and/or accompanying documents mean that used electrical and electronic products and batteries should not be mixed with general household waste.



For proper treatment, recovery and recycling of old products and used batteries, please take them to applicable collection points, in accordance with your national legislation and the Directives 2002/96/EC and 2006/66/EC.



By disposing of these products and batteries correctly, you will help to save valuable resources and prevent any potential negative effects on human health and the environment which could otherwise arise from inappropriate waste handling.



Pb

For more information about collection and recycling of old products and batteries, please contact your local municipality, your waste disposal service or the point of sale where you purchased the items.

[Information on Disposal in other Countries outside the European Union]

These symbols are only valid in the European Union. If you wish to discard these items, please contact your local authorities or dealer and ask for the correct method of disposal.

Note for the battery symbol (bottom two symbol examples):

This symbol might be used in combination with a chemical symbol. In this case it complies with the requirement set by the Directive for the chemical involved.

If there should be color blotching or noise when used near a TV, move this unit away from the TV when using it.

Do not use this unit within 22 cm (9 inches) of persons with a heart pacemaker implant or defibrillator implant.

Radio waves may affect electro-medical devices.
Do not use this unit near medical devices or inside medical facilities.

The user shall not reverse engineer, decompile, alter, translate or disassemble the software used in this unit, whether in part or in whole. For corporate users, employees of the corporation itself as well as its business partners shall observe the contractual bans stipulated within this clause. If the stipulations of this clause and this contract cannot be observed, the user shall immediately discontinue using the software.

LASER

Type	Semiconductor laser GaAs/GaAlAs
Wave length	790 nm
Output Power	7 mW

CAUTION

Use of controls or adjustments or performance of procedures other than those specified herein may result in hazardous radiation exposure.

■ For U.K. customers

If the socket outlets in the home are not suitable for the plug supplied with this appliance, it should be cut off and an appropriate 3 pin plug fitted. For details, refer to the instructions described below.



The plug severed from the mains lead must be destroyed, as a plug with bared flexible cord is hazardous if engaged in a live socket outlet.

■ Special Instructions for U.K. Model

IMPORTANT

THE WIRES IN MAINS LEAD ARE COLOURED IN ACCORDANCE WITH THE FOLLOWING CODE:

Blue: NEUTRAL

Brown: LIVE

As the colours of the wires in the mains lead of this apparatus may not correspond with the coloured markings identifying the terminals in your plug, proceed as follows:

The wire which is coloured BLUE must be connected to the terminal which is marked with the letter N or coloured BLACK. The wire which is coloured BROWN must be connected to the terminal which is marked with the letter L or coloured RED.

Make sure that neither core is connected to the earth terminal of the three pin plug.

The laser component in this product is capable of emitting radiation exceeding the limit for Class 1.

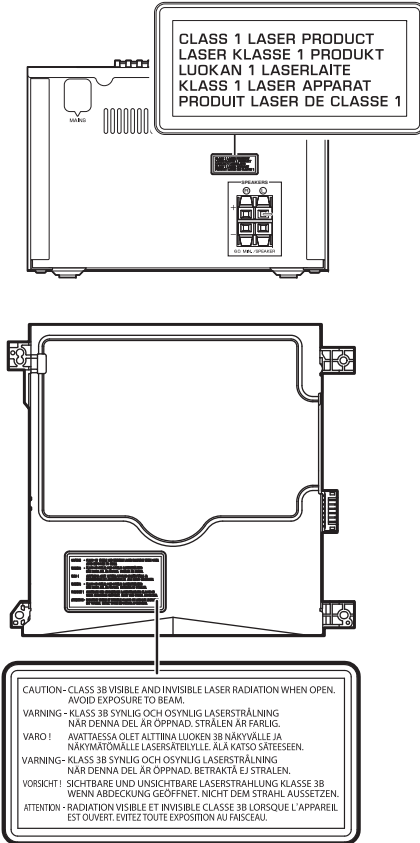

Important Notice: Guarantee Information for customers in EEA* and Switzerland**English**

For detailed guarantee information about this Yamaha product, and Pan-EEA* and Switzerland warranty service, please either visit the website address below (Printable file is available at our website) or contact the Yamaha representative office for your country. * EEA: European Economic Area

<http://europe.yamaha.com/warranty/>