



**ホルン**  
取扱説明書

日本語

**French Horn**  
Owner's Manual

English

**Waldhorn**  
Benutzerhandbuch

Deutsch

**Cor**  
Mode d'emploi

Français

**Trompa**  
Manual de instrucciones

Español

**Trompa Francesa**  
Manual do Proprietário

Português

**圆号**  
使用说明书

简体中文

**Валторна**  
Руководство пользователя

Русский

**호른**  
사용설명서

한국어

**法國號**  
使用說明書

繁體中文

JA EN DE FR ES PT ZH-CN RU KO ZH-TW

このたびは、ヤマハ管楽器をお買い上げいただき、まことにありがとうございます。楽器を正しく組み立て性能をフルに発揮させるため、また永く良い状態で楽器をお使いいただくために、この取扱説明書をよくお読みください。

**P.3**

You are now the owner of a high quality musical instrument. Thank you for choosing Yamaha. For instructions on the proper assembly of the instrument, and how to keep the instrument in optimum condition for as long as possible, we urge you to read this Owner's Manual thoroughly.

**P.3**

Sie sind nun der stolze Besitzer eines hochwertigen Musikinstruments. Vielen Dank, dass Sie sich für ein Instrument der Marke Yamaha entschieden haben. Um mit den Handgriffen zum Zusammenetzen und Zerlegen des Instruments vertraut zu werden und dieses über Jahre hinweg in optimalem Zustand halten zu können, raten wir Ihnen, diese Anleitung aufmerksam durchzulesen.

**P.3**

Vous êtes dès à présent le propriétaire d'un instrument de musique de haute qualité. Nous vous remercions d'avoir choisi Yamaha. En ce qui concerne les instructions relatives à un assemblage adéquat de l'instrument et sur la façon de garder l'instrument dans des conditions optimales aussi longtemps que possible, nous vous conseillons vivement de lire entièrement le présent Mode d'emploi.

**P.3**

Usted es ahora propietario de un instrumento musical de alta calidad. Le agradecemos su elección de un instrumento Yamaha. Le aconsejamos que lea todo este manual de instrucciones para ver las instrucciones para el montaje correcto del instrumento y para aprender a conservar el instrumento en óptimas condiciones durante tanto tiempo como sea posible.

**P.3**

Agora você é o proprietário de um instrumento musical de alta qualidade. Obrigado pela sua escolha de um instrumento Yamaha. Para instruções da montagem correta do instrumento, e de como conservar o instrumento em condições ideais pelo maior tempo possível, pedimos que você leia este Manual do Proprietário por completo.

**P.3**

现在您已经是高品质乐器的主人了！感谢您选择 Yamaha 乐器。有关如何正确地安装乐器以及使乐器尽可能长久地处于最佳状况的说明，请完整地阅读该使用说明书。

**P.3**

Вы стали обладателем высококачественного музыкального инструмента. Благодарим вас за выбор продукции Yamaha. Для получения инструкций по правильной сборке данного инструмента и его длительном хранении в оптимальных условиях мы настоятельно рекомендуем вам внимательно прочитать настоящее руководство.

**P.3**

야마하 악기를 구입해 주셔서 감사합니다. 악기의 알맞은 조립 방법 및 보관을 위해 본 사용설명서를 반드시 읽어주시기 바랍니다.

**P.3**

感謝您選擇 Yamaha 購買優質樂器。如需瞭解如何正確組裝樂器，以及如何讓樂器盡可能長時間保持最佳狀態，強烈建議您詳閱本使用說明書。

**P.3**

# French Horn

## Owner's Manual

### Precautions Please read before using

The precautions given below concern the proper and safe use of the instrument, and are to protect you and others from any damage or injuries. Please follow and obey these precautions.

If children are using the instrument, a guardian should clearly explain these precautions to the child and make sure they are fully understood and obeyed. After reading this manual, please keep it in a safe place for future reference.

#### ■ About the Icons

: This icon indicates points which should be paid attention to.

: This icon indicates actions that are prohibited.

#### **Caution**

Disobeying the points indicated with this mark may lead to injury.

 **Do not throw or swing the instrument.**  
The mouthpiece or other parts may fall off hitting other people. Always treat the instrument gently.

 **Keep the oil, polish, etc., out of children's mouths.**  
Keep the oil, polish, etc., out of children's reach and do maintenance when children are not present.

 **Keep small parts out of the reach of infants.**  
Your children may accidentally swallow them.

#### NOTICE

- **Be aware of climatic conditions such as temperature, humidity, etc.**

Keep the instrument away from heat sources such as heaters, etc. Also, do not use or store the instrument in any extreme conditions of temperature or humidity. Doing so may result in damage to key balance, linkage, or pads, resulting in problems during performance.

- **Never use benzene or thinner for maintenance on instruments with a lacquer finish.**  
Doing so may result in damage to the finish's top coat.

- **Take care not to disfigure the instrument.**  
Placing the instrument where it is unstable may cause the instrument to fall or drop resulting in disfigurement. Take care as to where and how you place the instrument.

- **Do not modify the instrument.**  
Besides voiding the warranty, modification of the instrument may make repairs impossible.

**In regards to brass instruments with a plate finish, the color of the finish may change over time however, it should be of no concern in regards to the instrument's performance. Discoloration in its early stage can easily be removed with maintenance. (As discoloration progresses, it may be difficult to remove.)**

\* Please use the accessories that are specified for use with the particular type of finish found on the instrument. Also, metal polishes remove a thin layer of the finish's top coat which will make the finish thinner. Please be aware of this before using polish.



# Nomenclature

## ■ F Single Horn

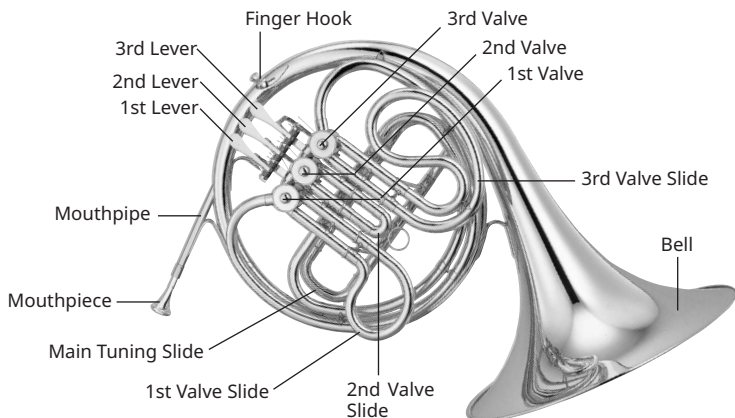

## ■ B $\flat$ Single Horn

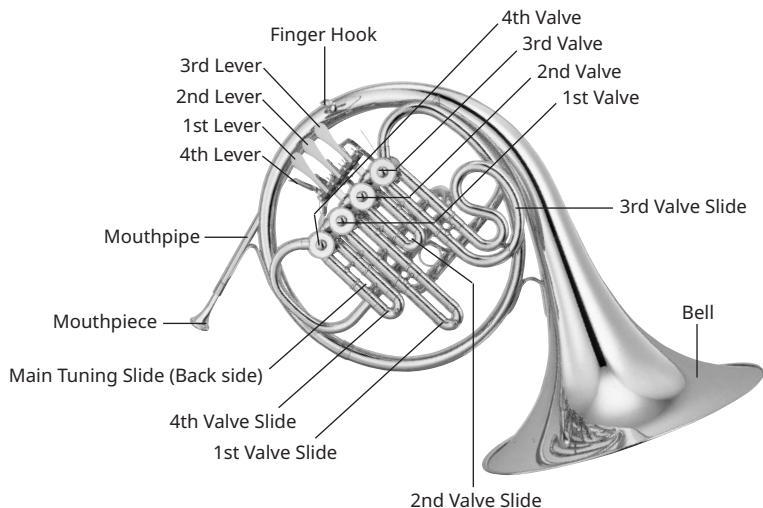

## ■ F/B $\flat$ Double Horn

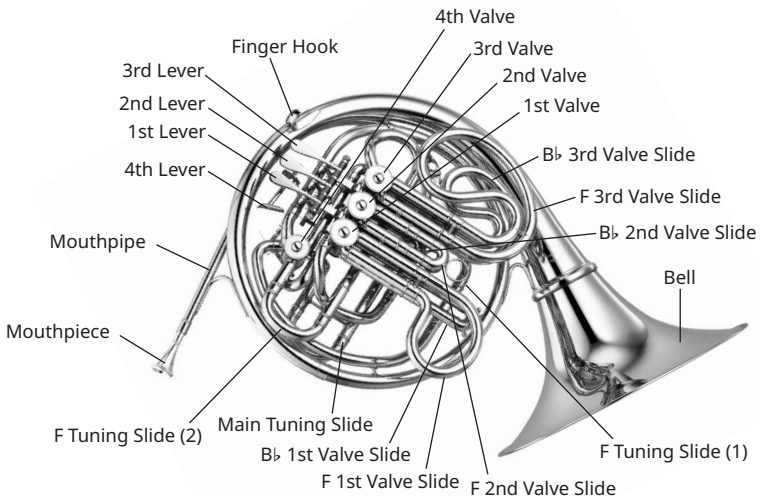
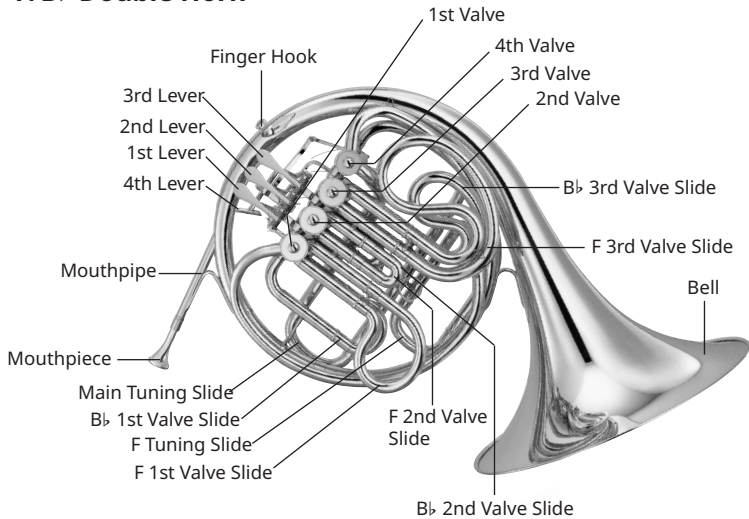

\* The contents of this manual apply to the latest specifications as of the publishing date. To obtain the latest manual, access the Yamaha website then download the manual file.

# Before You Play

## Handling the Instrument

The instrument is made of a thin metal so please handle it with care. Do not apply any excessive force to the instrument, or bump it in a manner that will dent or damage it.

## ■ Attaching the Screw-On Bell

When attaching the screw-on bell, always hold the bell by its mid section and assemble. Do not over-tighten.



## ■ Lubrication

### Oiling the Rotors

1. While holding the levers down, remove the valve slides then apply rotor oil to the rotors as shown in the illustration below (a few drops per rotor).

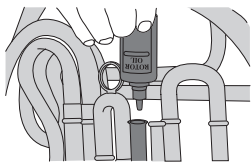

- \* Apply oil if the lever does not work smoothly.
- \* When applying oil, do not let the oil mix with the slide grease adhering to the valve slide's interior.

2. Move the levers so that the oil is spread evenly.

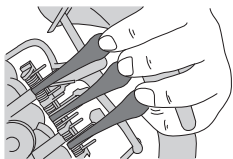

## ■ Attaching the Mouthpiece

Gently insert the mouthpiece into the mouthpipe.

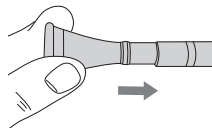

- \* Never force the mouthpiece into the mouthpipe. The mouthpiece may become stuck in the mouthpipe.

# Tuning

Use the main tuning slide to make sure that the instrument is in tune before playing. Since temperature has an effect on the instrument's pitch, blow some warm air through it to warm it up before tuning. The amount of tuning slide adjustment needed to get the horn in tune will vary between individuals so there is no standard rule to follow (however, at 68°F pulling the main tuning slide out about 0.6" should more or less tune the instrument to A=442Hz).

Take notice that when temperatures are warmer, the main tuning slide should be pulled out a little more, while cooler temperatures will require that you push the slide in. Also, the position and angle of your right hand in the bell will have an influence on pitch as well.

## Single Horns

Slide the main tuning slide in or out to tune the instrument.

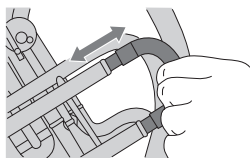

## Double Horns

1. Use the main tuning slide to tune the B $\flat$  side.

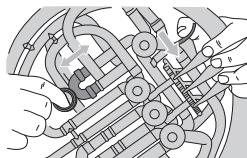
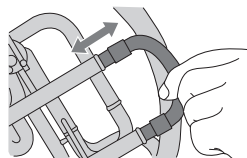

\* Instruments with a B $\flat$  tuning slide should tune with the main tuning slide as well.

2. Use the F tuning slide to tune the F side of the instrument.

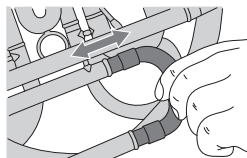

# Tuning

- 3.** Pull out each of the valve slides between 1/5-2/5 inch. When pulling out the slides, make sure that the lever corresponding to the slide is depressed.

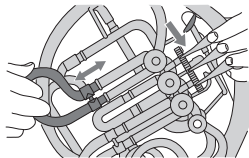

- 4.** The 4th valve on the B $\flat$  single horn is designed so that you can play with normal fingering when performing the hand-stopping technique. Also, you can play as a semitone lower with the 4th lever pressed when you detach the extension tube from the 4th valve as shown in the illustration below. In other words, you can play as an A single horn.

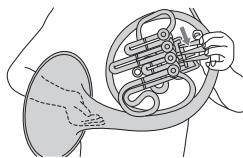
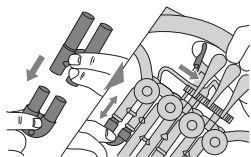

**\* What is the hand-stopping technique**

Hand-stopping is a technique by which a French horn can be made to produce a characteristic metallic sound. When you play by this technique, you need to play with fingering that is a semitone lower than the note written in the score because the F single horn and the double horn (F horn side) produce pitches of a semitone higher. Also, since the B $\flat$  single horn produces

pitches from 2/3 to 3/4 higher, you can use regular fingerings by pressing the 4th valve on the B $\flat$  single horn.



# Maintenance

## ■ Caring for your instrument after playing

To keep your instrument both looking and playing well, make sure you take proper care of it after you have finished playing. When caring for the instrument, place it on a table or, hold it securely in your hands, taking care not to drop it.

### ● Valve Slide Maintenance

1. Remove the valve slides to remove any moisture.

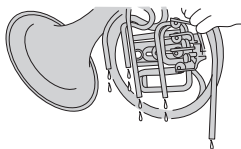

\* Removing the valve slide without holding the corresponding lever down creates a drop in air pressure within the pipe, creating a suction that can result in poor rotor function or damage to the inside of the pipe.

2. If the instrument has a water key, remove moisture from the water key too.

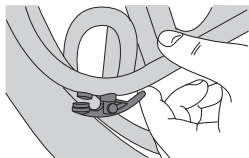

- \* The valve slides are made of brass or nickel silver, which are both excellent at resisting corrosion. However, corrosion may appear if moisture is left in the instrument for an extended period of time. Please use caution.
- \* To effectively remove moisture from inside the instrument, use a cleaning swab.

### ● Body Maintenance

Use a polishing cloth to gently wipe the instrument's surface. If dirt or tarnish is obvious, the following products can be used.

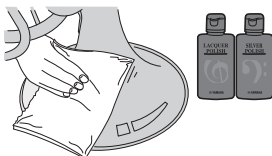

#### For lacquer finishes...

Lacquer cloth + lacquer polish

#### For silver plate...

Silver cloth + silver polish

## ■ Once a Week Maintenance

### ● Rotor Maintenance

1. Remove the cap on the rotor valve and apply a little rotor spindle oil to the rotor bearings.

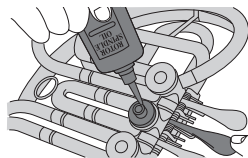

- \* After applying the oil, remove any excess oil. Finally, replace the cap and move the lever a few times to distribute the oil evenly.

# Maintenance

2. Apply a little rotor spindle oil to the rotor spindle and receiver.

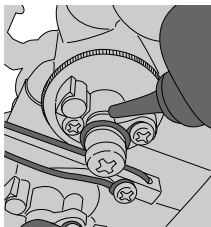
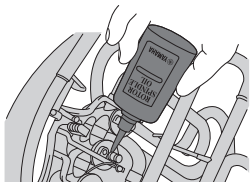

3. Apply a little lever oil to each linkage of the lever assembly.

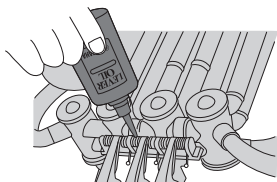

\* Remove excess oil and use a gauze cloth to clean the smaller parts.

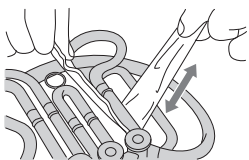

## Once or Twice a Month Maintenance

### ● Valve Slide Maintenance

1. Depress the valve levers and remove the valve slides.

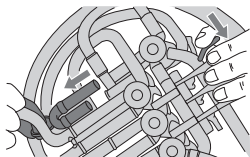

2. Wrap a cleaning rod with a gauze cloth leaving no bare metal exposed, and remove dirt from the insides of the valve slides and the outer pipes.

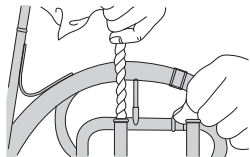
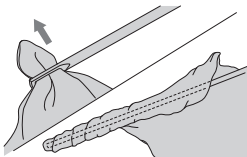

3. Use the gauze to remove dirt from the surface of the valve slide, then apply a little slide grease.

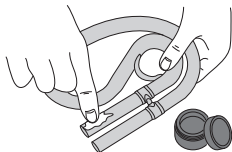

4. Slide the valve slide in and out a few times to distribute the grease evenly. Then wipe off any extra grease that comes off the slide.

## ■ Twice Yearly Maintenance

### ● Cleaning the Instrument

1. Prepare a brass soap water solution using between 10 to 15 parts warm water (78°F to 88°F) and 1 part brass soap. Before putting the instrument into the solution, remove the valve slides.
2. Apply some soap water solution to the brush on the end of flexible cleaner and use the cleaner to clean the inside of the instrument's tubing.

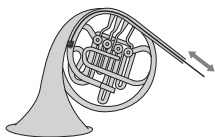

3. After cleaning the instrument, use clean water to thoroughly rinse out the dirt and soap.

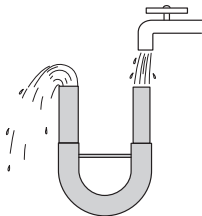

4. After completely removing all moisture with a gauze, apply oil and grease.

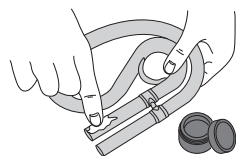
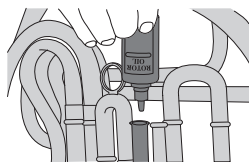

### Take Care When Cleaning Inside of the Instrument

Never dismantle the rotors. Also, when rinsing the tubing with water, run water through the main tuning slides in the opposite direction of the airflow. If water is run through the instrument from the mouthpiece, dirt can become clogged in the valves causing the valves to become sluggish.

5. Apply some soap water solution to a mouthpiece brush and insert it into the throat to clean the mouthpiece, then thoroughly rinse it out with clean water.

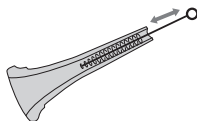



# Adjusting the Rotary String and the Lever Function

**Winding and adjusting the rotary string is difficult for beginner players. Please consult with a wind instrument technician.**

- **Wind the string as shown in the illustration below, and tighten the string stopper screw.**

Wind the string around the screw in the same direction that the screw tightens. After winding, use the String Stopper Screw B to adjust the lever's height.

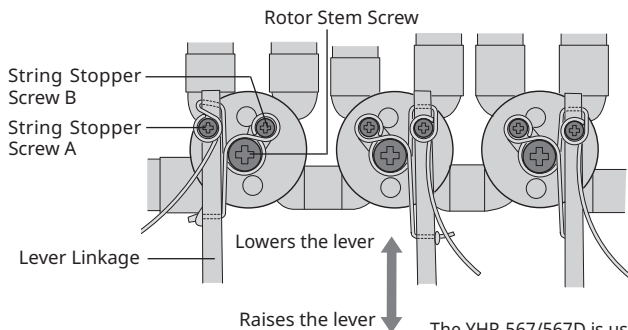

The YHR-567/567D is used in this illustration.

You can change the stroke from long to short by changing the position of the bearing stopper screw on the mechanical action type, the YHR-567G(D)B, etc.

\* When the bearing stopper screw is installed near the rotating center, the stroke will become short. When the screw is installed far from the rotating center, the stroke will become long.

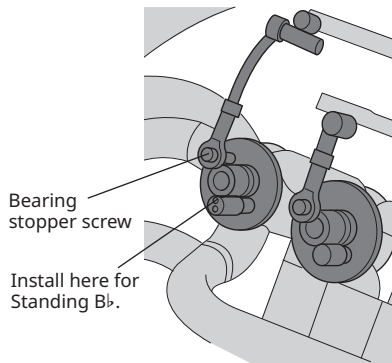

The 4th lever with an adjustment mechanism can be adjusted to better fit the player's hand size and position. Use a screw driver and adjust the lever length as shown in the illustration below.

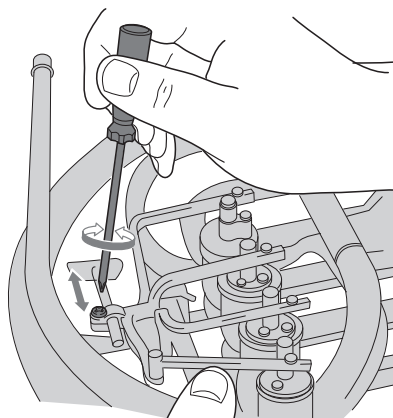

# Adjusting the Rotary String and the Lever Function

## ■ Switching the 4th Lever Function

### ● F/B $\flat$ Double Horn

The Yamaha double horn is designed so that it normally plays in the key of F (standing F) when the 4th lever is not depressed, and in the key of B $\flat$  when the 4th lever is depressed. However, by re-configuring the linkage as shown in the illustration below, this function can be reversed so that the horn plays in B $\flat$  (standing B $\flat$ ) when the lever is not depressed, and in the key of F when the lever is depressed.

To use this setup, move the string and the string seat, then place the string over the string seat.

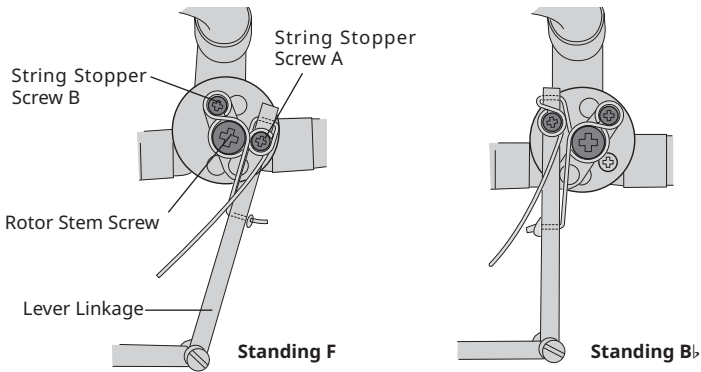

The above figure shows a double horn with the 4th valve on the little finger side.

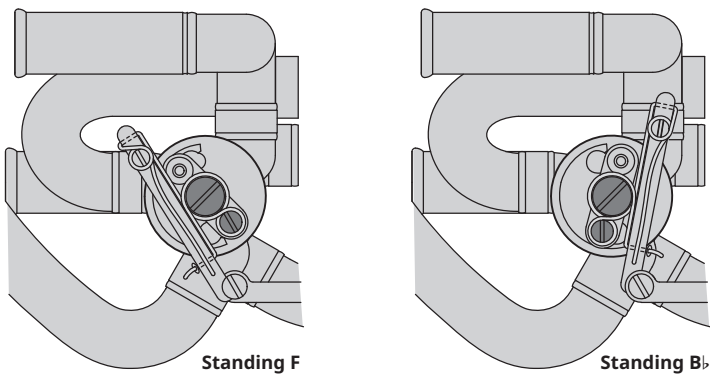

The above figure shows a double horn with the 4th valve on the thumb side.

# Options

## ● E $\flat$ Crook (optional)

This optional main tuning slide is designed for the F single horn, turning it into an E $\flat$  horn so that you can play E $\flat$  parts without transposing.

The crook is designed so that the horn fits in the case when it is attached.

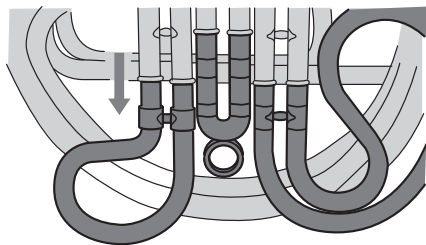
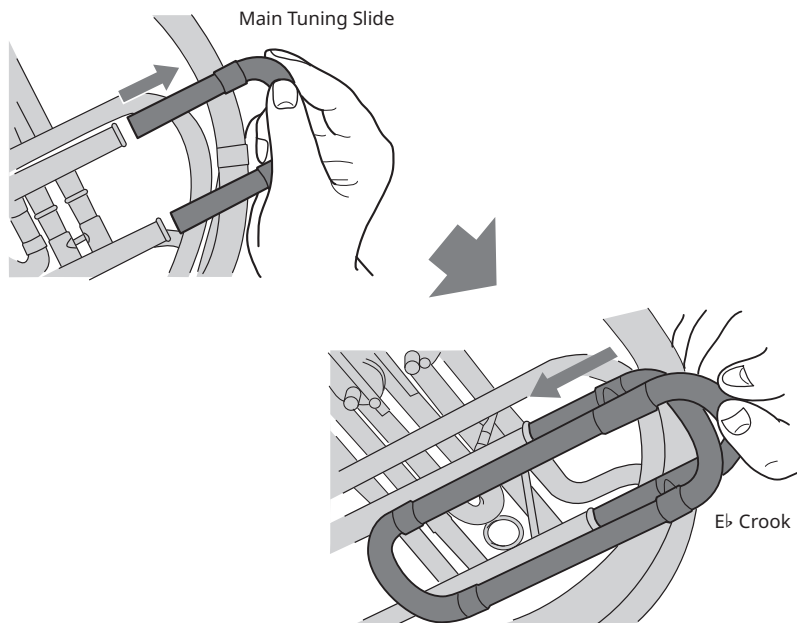

When using the E $\flat$  crook, the 1st through 3rd valve tuning slides should be pulled out a little.

## ● F Natural Slide (optional)

When attached to the B $\flat$  single horn's 4th valve slide, the F natural slide offers the sound of the F natural harmonic series. It enhances clarity in the mid-low range such as C (actual F) or G (actual C) and stable intonation.

The F Natural Slide is designed so that the horn fits in the case when attached.

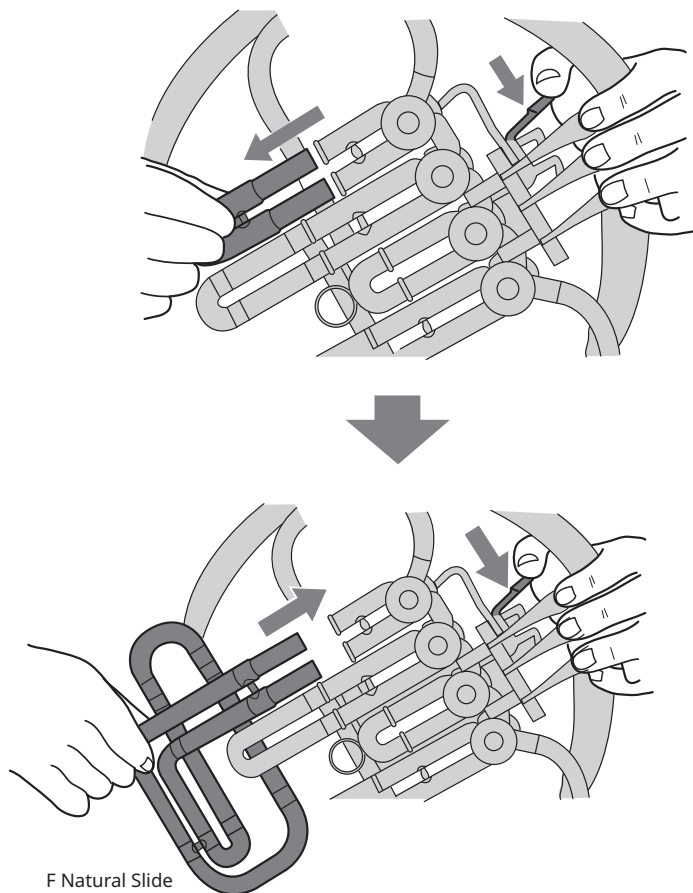

# Troubleshooting

## **Tone is not clear and pitch is poor.**

- **Dirt has accumulated inside the tubing.**
  - Use the procedure described in the "Valve Slide Maintenance" section and wash out the insides of the tubing.
- **The water key cork is cracked causing air to leak.**
  - Replace the water key cork with a new one.
- **The mouthpiece is loose and rattles, and air is leaking from around the mouthpiece.**
- **There is a large dent in the tubing, and air is leaking from the ferrules where the tubing connects.**
- **There is a foreign object in the tubing.**
- **Holes in the rotors are not aligned with holes in the valve casing branches.**
  - Contact the dealer from whom you purchased the instrument.

## **The rotors are sluggish.**

- **The string is loose.**
  - Use a screwdriver and tighten the string.
- **Dirt has accumulated between the valve casing and rotor.**
- **The valve casing is deformed.**
- **The rotary valve was disassembled, then reassembled.**
  - Contact the dealer from whom you purchased the instrument.

## **The valve slide is stuck and can not be removed. The slide is sluggish.**

- **Dirt or dust has accumulated between the outer and inner slides and the valve slide is damaged.**
  - Remove dirt from the slides then apply some slide grease.
- **Dropping or hitting the slide has created a dent, or the slide was bent while cleaning.**
  - Contact the dealer from whom you purchased the instrument.

## **The screw is too tight and can not be loosened.**

- **The screw is corroded.**
- **Hitting the screw has damaged it.**
  - Contact the dealer from whom you purchased the instrument.

## **The mouthpiece can not be removed.**

- **The instrument was dropped or hit with the mouthpiece attached. Or, the mouthpiece was inserted with too much force.**
- **The instrument was left for a long period of time with the mouthpiece inserted in the instrument.**
  - Contact the dealer from whom you purchased the instrument.

## **The instrument makes an abnormal sound when played.**

- **Solder on the instrument has come loose.**
- **There is a foreign object in the tubing.**
  - Contact the dealer from whom you purchased the instrument.







# フィンガリングチャート / Fingering Chart / Griffabelle / Tablature /

F シングルホルン

F Single Horn

F-Einfachhorn

Cor simple en Fa

Trompa en Fa sencilla

Trompa simples em Fá

F 单排圆号

Одиная валторна F

F 싱글 호른

F 單調性法國號

## A



B $\flat$  シングルホルン

B $\flat$  Single Horn

B-Einfachhorn

Cor simple en Si $\flat$

Trompa en Si $\flat$  sencilla

Trompa simples em Si bemol

降 B 单排圆号

Одиная валторна B $\flat$

B $\flat$  싱글 호른

降 B 單調性法國號

## B



### in F

●: 押さえる / Close / Geschlossen / Fermé / Cerrado / Fechado / 按下 / Закрыт / 닫기 / 按下  
○: 放す / Open / Offen / Ouvert / Abierto / Aberto / 放开 / Открыт / 열기 / 放开

		Bass Clef									
		F	F $\sharp$	F $\flat$	F	F $\sharp$	F $\flat$	F	F $\sharp$	F $\flat$	F
A	3	○							●	●	●
	2	○							●	○	●
	1	○							●	●	○
B	4	○	○	○ ○	○	○	○				
	3	●	●	○ ●	○	○	○				
	2	○	●	● ○	○	●	○				
C	1	●	○	● ○	●	○	○				
	4	○ ●	●	● ●	●	●	●	○	○	○	
	3	○ ●	●	○ ●	○	○	○	●	●	●	
	2	○ ○	●	● ○	○	●	○	●	○	●	
	1	○ ●	○	● ○	●	○	○	●	●	○	

# Tabla de digitaciones / Tabela de digitação / 指法表 / Аппликатура / 운지법 / 指法表

F/B♭ **ダブルホルン**

F/B♭ **Double Horn**

F/B-Doppelhorn

Cor double en Fa/Si♭

Trompa doble en Fa/Si♭

Trompa dupla em Fá/Si bemol

F/ 降 B 双排圆号

Двойная валторна F/B♭

F/B♭ **더블 호른**

F/ 降 B 雙調性法國號

**C**



ダブルホルンの第4レバーは、F管とB♭管の切り替えに使用します。工場出荷時は、第4レバーを押すと、F管からB♭管に切り替わるようにセットされています。

The 4th lever on full double horns is used to switch between the F and B♭ sides of the horn. When shipped from the factory, this valve is set so that the horn changes from the F side to the B♭ side when the 4th lever is pressed.

Der vierte Hebel von echten Doppelhörnern dient zum Umschalten zwischen der F- und B-Seite des Horns. Bei der Auslieferung des Instruments ist dieses Ventil so eingerichtet, dass das Horn beim Betätigen des Hebels von der F-Seite zur B-Seite wechselt.

La 4ème palette des cors doubles sert à faire passer l'instrument de Fa en Si♭. Par défaut, elle est configurée de telle sorte que le cor joue en Fa lorsqu'elle n'est pas enfoncée et qu'il joue en Si♭ lorsqu'elle est enfoncée.

La cuarta espátula de las trompas dobles completas se emplea para cambiar entre los lados de Fa y Si♭ de la trompa. Cuando la trompa sale de fábrica, este cilindro está ajustado para que la trompa cambie del lado de F al de B♭ cuando se presiona la cuarta espátula.

A quarta chave da trompa dupla é usada para alternar entre os lados Fá e Si da trompa. Quando sai da fábrica, está chave esta ajustada para o lado Fá, ativando o lado si quando a quarta chave é acionada.

双管圆号的第四连杆用于 F 调与降 B 调之间的转换。出厂设置为：按下第四连杆时，圆号从原来的 F 调改发降 B 调。

4-я клавиша на двойных валторнах используется для переключения между строями F и B♭. При поставке с завода клапан настроен таким образом, что переключение между F и B♭ осуществляется нажатием 4-й клавиши.

플 더블 호른의 4th 레버는 호른의 F 및 B♭ 사이드 간의 전환을 위해 사용됩니다. 공장 출고 시, 본 밸브는 4th 레버를 누를 경우 F 사이드에서 B♭ 사이드로 바뀌도록 설정된 상태로 출고됩니다.

標準雙調性法國號的第4連桿用於切換F調和降B調。出廠設置為：按下第4連桿時，法國號會從F調變成降B調。

	F	F♯	G	G♯	A	A♯	B	B♭	C	C♯
1	○	○	○	○	○	○	○	○	○	○
2	○	○	○	○	○	○	○	○	○	○
3	○	○	○	○	○	○	○	○	○	○
4	○	○	○	○	○	○	○	○	○	○
5	○	○	○	○	○	○	○	○	○	○
6	○	○	○	○	○	○	○	○	○	○
7	○	○	○	○	○	○	○	○	○	○
8	○	○	○	○	○	○	○	○	○	○
9	○	○	○	○	○	○	○	○	○	○
10	○	○	○	○	○	○	○	○	○	○
11	○	○	○	○	○	○	○	○	○	○
12	○	○	○	○	○	○	○	○	○	○



# フィンガリングチャート / Fingering Chart / Grifftabelle / Tablature /

A	3	○	●	○ ●	○	○	○	○	○	○
	2	○	●	● ○	○	●	○	●	○	●
	1	○	○	● ○	●	○	○	●	●	○
B	4	● ○	○	○ ○	○	○	○	○	○ ○	○
	3	● ●	●	○ ●	○	○	○	●	○ ●	○
	2	● ○	●	● ○	○	●	○	●	● ○	○
1	○ ●	○	● ○	●	○	○	○	○	● ○	●
C	4	○	○ ●	○ ●	○ ●	○ ●	○ ●	○ ●	○ ●	○ ●
	3	○	● ●	○ ○	○ ○	○ ○	○ ○	○ ●	○ ○	○ ○
	2	○	● ●	● ●	○ ○	● ●	○ ○	● ●	○ ○	● ○
	1	○	○ ○	● ●	● ●	○ ○	○ ○	○ ○	● ○	● ●

A

A	3	○	○ ○	○	○	○	● ○	○ ○	○ ○	○ ○
	2	●	○ ●	○	●	○	● ○	● ●	○ ○	● ○
	1	○	○ ●	●	○	○	○ ●	● ○	●	○ ○
B	4	○	○	○	○	○	○ ○	○ ○ ○	○	○ ○
	3	○	○	○	○	○	● ○	○ ● ○	○	○ ○
	2	○	●	○	●	○	● ●	○ ○ ○	○	● ○
1	●	○	○	○	○	○ ○	● ○ ○	●	○ ○	
C	4	●	●	●	●	●	● ●	● ● ●	●	● ●
	3	○	○	○	○	○	● ○	○ ● ○	○	○ ○
	2	○	●	○	●	○	● ●	● ○ ○	○	● ○
	1	●	○	○	○	○	○ ○	● ○ ○	●	○ ○

● : 押さえる / Close / Geschlossen / Fermé / Cerrado / Fechado / 按下 / Закрыт / 닫기 / 按下  
 ○ : 放す / Open / Offen / Ouvert / Abierto / Aberto / 放开 / Открыт / 열기 / 放开

# Tabla de digitaciones / Tabela de digitação / 指法表 / Аппликатура / 운지법 / 指法表

A											
○	○	○	○	●	○●	○	○	○	○	○	○
○	○	●	○	●	●○	○	○	○	○	●	●
○	●	○	○	○	●○	○	○	○	○	○	○
○	○	○	○	○	○	○	○	○	○	○	○
○	○	○	○	○	○	○	○	○	○	○	○
○	○	○	○	○	○	○	○	○	○	○	○
○	○	○	○	○	○	○	○	○	○	○	○
○	○	○	○	○	○	○	○	○	○	○	○
○	○	○	○	○	○	○	○	○	○	○	○
○	○	○	○	○	○	○	○	○	○	○	○
○	○	○	○	○	○	○	○	○	○	○	○
○	○	○	○	○	○	○	○	○	○	○	○
○	○	○	○	○	○	○	○	○	○	○	○
○	○	○	○	○	○	○	○	○	○	○	○
○	○	○	○	○	○	○	○	○	○	○	○
○	○	○	○	○	○	○	○	○	○	○	○
○	○	○	○	○	○	○	○	○	○	○	○
○	○	○	○	○	○	○	○	○	○	○	○
○	○	○	○	○	○	○	○	○	○	○	○
○	○	○	○	○	○	○	○	○	○	○	○
○	○	○	○	○	○	○	○	○	○	○	○
○	○	○	○	○	○	○	○	○	○	○	○

慣例上古典派、ロマン派等の曲で、ヘ音記号はこれより 1 オクターブ下げて書かれるものもあります。同一の音で 2 種類ある運指は、一般的に左側にも書かれている運指を右側は替え指です。

Some bass clef parts in Classical and Romantic, etc., music are customarily written an octave lower. The fingering on the left should be played for notes that have double fingerings. The fingering on the right is an alternate fingering.

Manche Bassschlüssel-Partituren sind in der Romantischen oder Klassischen Musik oft eine Oktave tiefer geschrieben. Noten mit Doppelgriff sollten mit dem linken Griff gespielt werden. Beim rechts angegebenen Griff handelt es sich um einen alternativen Griff.

Certain parties of basse des musiques classiques, romantiques, etc. sont écrites une octave plus bas. Les doigts de gauche doivent être utilisés pour les notes à double doigté. Les doigts de droite représentent un autre doigté possible.

Algunas partes de a clave de bajos de música clásica y romántica, etc., están escritas especialmente una octava menos. El digitado de la izquierda debe tocarse para notas que tienen doble digitado. El digitado de la derecha es un digitado alternativo.

Algumas partes em clave de Fá dos períodos Clássico e Romântico costumam estar uma oitava abaixo. O dedilhado da esquerda deve ser usado para notas que tem dedilhado duplo. O dedilhado da direita é um dedilhado alternativo.

古典和浪漫主义音乐的一些低音谱号在习惯上会降低一个八度。应当注意左手指法是双指法，而右手指法为交替指法。

Некоторые партии в басовом ключе в жанрах классицизма и романтизма и т.д. традиционно пишутся на октаву ниже. Аппликатура слева используется для нот с двойной аппликатурой. С правой стороны - альтернативное положение пальцев.

고전주의, 낭만주의 계열 음악에서는 일반적으로 낮은자리표 부분을 1 옥타브 낮게 표시합니다. 왼쪽의 운지법은 양손 운지법 악보를 위해 사용해야 합니다. 오른쪽의 운지법은 대체 운지법입니다.

部分古典时期和浪漫时期的乐谱习惯将低音谱低一个八度。同一个音有两种指法时，一般情况下应使用左侧指法。右侧为替代指法。

A  
ダブルホルンの場合、通常はB $\flat$ に切り替えて演奏する音域です。

For double horns, this range is usually played on the B $\flat$  side of the horn.

Bei Doppelhörnern wird dieser Bereich gewöhnlich auf der B-Seite des Horns gespielt.

Sur les cors doubles, ce registre est en général joué avec le cor réglé en Si  $\flat$ .

Para las trompas dobles, este margen se toca normalmente en el lado de Si $\flat$  de la trompa.

Nas trompas duplas, esta extensão normalmente é tocada no lado Si $\flat$  da trompa.

通常使用双管圆号的降 B 调演奏此音域。

Для двойных валторн эта последовательность обычно играется в строе B $\flat$ .

더블 호른의 경우 이 음역은 보통 B $\flat$  음역에서 연주합니다.

雙調性法國號通常會以降 B 調演奏此音域。



**ヤマハ株式会社**

〒430-8650 静岡県浜松市中央区中沢町 10-1

© 2013 Yamaha Corporation  
Published 09/2023 発行 IPCC-A0

VGS2800