

YAMAHA

KX-W421

KX-W321

Natural Sound Stereo Cassette Deck

OWNER'S MANUAL

Platine à cassette stéréo de la série "Natural Sound"

MODE D'EMPLOI

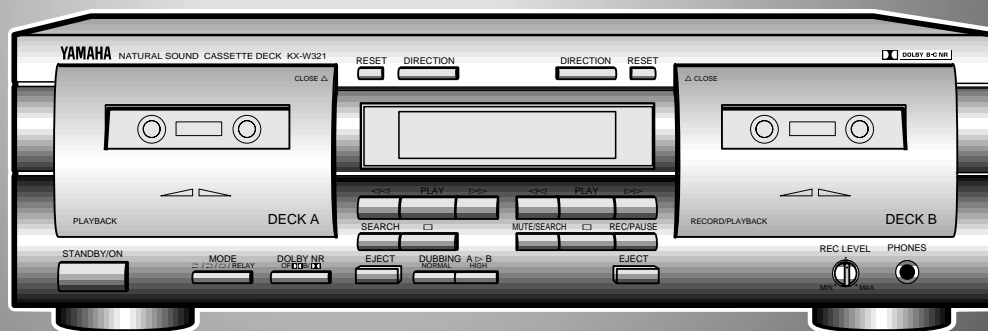
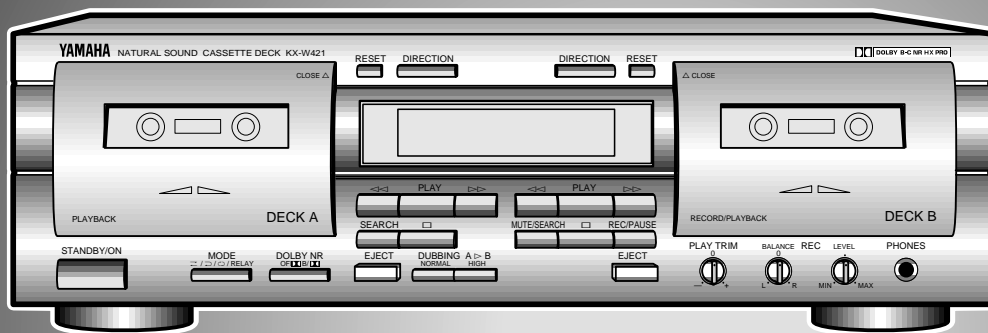

Thank you for purchasing this YAMAHA stereo cassette deck.

SAFETY INSTRUCTIONS



● Explanation of Graphical Symbols



The lightning flash with arrowhead symbol, within an equilateral triangle, is intended to alert you to the presence of uninsulated "dangerous voltage" within the product's enclosure that may be of sufficient magnitude to constitute a risk of electric shock to persons.



The exclamation point within an equilateral triangle is intended to alert you to the presence of important operating and maintenance (servicing) instructions in the literature accompanying the appliance.

WARNING

TO REDUCE THE RISK OF FIRE OR ELECTRIC SHOCK, DO NOT EXPOSE THIS APPLIANCE TO RAIN OR MOISTURE.

- 1** Read Instructions — All the safety and operating instructions should be read before the unit is operated.
- 2** Retain Instructions — The safety and operating instructions should be retained for future reference.
- 3** Heed Warnings — All warnings on the unit and in the operating instructions should be adhered to.
- 4** Follow Instructions — All operating and other instructions should be followed.
- 5** Water and Moisture — The unit should not be used near water — for example, near a bathtub, washbowl, kitchen sink, laundry tub, in a wet basement, or near swimming pool, etc.
- 6** Carts and Stands — The unit should be used only with a cart or stand that is recommended by the manufacturer.
- 6A** A unit and cart combination should be moved with care. Quick stops, excessive force, and uneven surfaces may cause the unit and cart combination to overturn.



7 Wall or Ceiling Mounting — The unit should be mounted to a wall or ceiling only as recommended by the manufacturer.

8 Ventilation — The unit should be situated so that its location or position does not interfere with its proper ventilation. For example, the unit should not be situated on a bed, sofa, rug or similar surfaces that may block the ventilation openings; or placed in a built-in installation, such as a bookcase or cabinet that may impede the flow of air through the ventilation openings.

9 Heat — The unit should be situated away from heat sources such as radiators, stoves, or other units that produce heat.

10 Power Sources — The unit should be connected to a power supply only of the type described in the operating instructions or as marked on the unit.

11 Power-Cord Protection — Power-supply cords should be routed so that they are not likely to be walked on or pinched by items placed upon or against them, paying attention to receptacles, and the point where they exit from the unit.

12 Cleaning — The unit should be cleaned only as recommended by the manufacturer.

13 No Use Periods — The power cord of the unit should be unplugged from the outlet when left unused for a long period of time.

14 Object and Liquid Entry — Care should be taken so that objects do not fall into and liquids not spilled into the inside of the unit.

15 Damage Requiring Service — The unit should be serviced by qualified service personnel when:

- A. The power-supply cord or the plug has been damaged; or
- B. Objects have fallen, or liquid has been spilled into the unit; or
- C. The unit has been exposed to rain; or
- D. The unit does not appear to operate normally or exhibits a marked change in performance; or
- E. The unit has been dropped, or the cabinet damaged.

16 Servicing — The user should not attempt to service the unit beyond those means described in the operating instructions. All other servicing should be referred to qualified service personnel.

17 Grounding or Polarization — The precautions should be taken so that the grounding or polarization of the unit is not defeated.

This unit is not disconnected from the AC power source as long as it is connected to the wall outlet, even if the unit itself is turned off. This state is called the standby mode. In this state, the unit is designed to consume a very small quantity of power.

FCC INFORMATION (U.S.A.)

1. IMPORTANT NOTICE: DO NOT MODIFY THIS UNIT!

This product, when installed as indicated in the instructions contained in this manual, meets FCC requirements. Modifications not expressly approved by Yamaha may void your authority, granted by the FCC, to use the product.

2. IMPORTANT: When connecting this product to accessories and/or another product use only high quality shielded cables. Cables supplied with this product MUST be used. Follow all installation instructions. Failure to follow instructions could void your FCC authorization to use this product in the USA.

3. NOTE: This product has been tested and found to comply with the requirements listed in FCC Regulations, Part 15 for Class "B" digital devices. Compliance with these requirements provides a reasonable level of assurance that your use of this product in a residential environment will not result in harmful interference with other electronic devices. This equipment generates/uses radio frequencies and, if not installed and used according to the instructions found in the users manual, may cause interference harmful to the operation of other electronic devices. Compliance with FCC regulations does not guarantee that interference will not occur in all installations. If this product is found to be the source of interference, which can be determined by turning the unit "OFF" and "ON", please try to eliminate the problem by using one of the following measures:

Relocate either this product or the device that is being affected by the interference.

Utilize power outlets that are on different branch (circuit breaker or fuse) circuits or install AC line filter/s.

In the case of radio or TV interference, relocate/reorient the antenna. If the antenna lead-in is 300 ohm ribbon lead, change the lead-in to coaxial type cable.

If these corrective measures do not produce satisfactory results, please contact your local retailer that is authorized to distribute this type of product. If you cannot locate the appropriate retailer, please contact Yamaha Electronics Corp., U.S.A.
6660 Orangethorpe Ave, Buena Park, CA 90620

The above statements apply ONLY to those products distributed by Yamaha Corporation of America or its subsidiaries.

CAUTION: READ THIS BEFORE OPERATING YOUR UNIT.

1. This unit is a sophisticated stereo cassette deck. To ensure proper operation for the best possible performance, please read this manual carefully.
2. Choose the installation location of your unit carefully. Avoid placing it in direct sunlight or close to source of heat. Also avoid locations subject to vibration and excessive dust, heat, cold or moisture. Keep it away from sources of hum such as transformers or motors.
3. Do not open the cabinet as this may result in damage to the deck or electrical shock. If a foreign object should get into the deck, contact your local dealer.
4. When removing the power plug from the wall outlet, always pull directly on the plug; never pull the cord itself.
5. Do not apply excessive force when operating switches and knobs.
6. When moving the deck, be sure to first pull out the power plug and remove all cords connecting the deck to other equipment.
7. Do not attempt to clean this unit with chemical solvents as this may damage the finish. Use a clean, dry cloth.
8. Never allow metallic items (e.g. screwdrivers, tools, etc.) to come near the record/playback head assembly. Doing so may not only scratch or damage the head's mirror-smooth finish, it may also change the magnetic characteristics of the heads, causing a deterioration in reproduction quality.
9. Although the record/playback head used in this unit is a high quality head with outstanding reproduction characteristics, it can become dirty through the use of old tapes or from dust accumulation over time. This can have a serious effect on reproduction quality. Clean the heads regularly with one of the commonly available head cleaners or with cleaning solutions as explained later in this manual.
10. Be sure to read the "TROUBLESHOOTING" section of this manual for advice on common operating errors before concluding that your unit is faulty.
11. Keep this manual in a safe place for future reference.
12. **Voltage Selector (General model only)**
The voltage selector on the rear panel of this unit must be set for your local mains voltage BEFORE plugging in the AC mains supply. (Voltage selector adjustable between 110/120/220/240 V AC.)

Note

Please check the copyright laws in your country to record from records, compact discs, radio, etc. Recording of copyright material may infringe copyright laws.

We Want You Listening For A Lifetime

YAMAHA and the Electronic Industries Association's Consumer Electronics Group want you to get the most out of your equipment by playing it at a safe level. One that lets the sound come through loud and clear without annoying blaring or distortion – and, most importantly, without affecting your sensitive hearing.

Since hearing damage from loud sounds is often undetectable until it is too late, YAMAHA and the Electronic Industries Association's Consumer Electronics Group recommend you avoid prolonged exposure to excessive volume levels.



FOR CANADIAN CUSTOMERS

TO PREVENT ELECTRIC SHOCK, MATCH WIDE BLADE OF PLUG TO WIDE SLOT AND FULLY INSERT.

THIS CLASS B DIGITAL APPARATUS MEETS ALL REQUIREMENTS OF THE CANADIAN INTERFERENCE-CAUSING EQUIPMENT REGULATIONS.

TABLE OF CONTENTS

FEATURES	4	DUBBING (From DECK A to DECK B)	13
CONNECTIONS	5	CASSETTE TAPES	14
NOTES ON THIS MANUAL	5	MAINTENANCE	15
PLAYBACK (Common to DECKs A and B)	6	OPTIONAL REMOTE CONTROL TRANSMITTER	15
BASIC OPERATION	6	TROUBLESHOOTING	16
SELECTION SEARCH	8	SPECIFICATIONS	17
RELAY PLAYBACK	9		
PLAY TRIM CONTROL ADJUSTMENT (KX-W421 only)	9		
RECORDING	10		
BASIC OPERATION	10		
REC MUTE OPERATION	12		
REC RETURN OPERATION	12		

FEATURES

- High Quality Hard Permalloy Recording/Playback Head in Deck B and Playback Head in Deck A
- Dolby B/C Noise Reduction
- Play Trim Control for improved playback compatibility with other decks (KX-W421 only)
- Auto Tape Selector
- Dolby HX Pro Dynamic Bias Servo (KX-W421 only)
- Relay Playback from DECK A to DECK B
- Selection Search
- Recording Mute Function
- Rec Return Operation
- Easy Dubbing Operation at Selectable Speed (Normal/High)
- Peak Level Meters with Peak Hold Function
- Remote Control Capability with Optional Remote Control Transmitter

Dolby noise reduction and HX Pro headroom extension manufactured under license from Dolby Laboratories Licensing Corporation. HX Pro originated by Bang & Olufsen.

"DOLBY", the double-D symbol  and "HX PRO" are trademarks of Dolby Laboratories Licensing Corporation.

CONNECTIONS

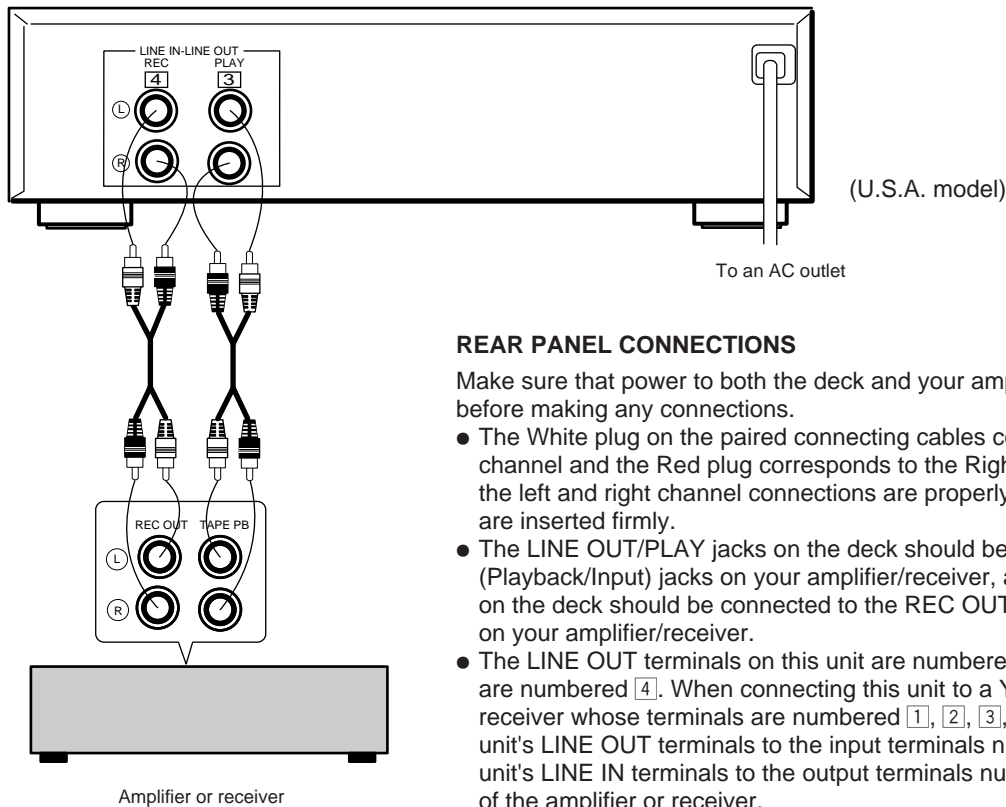

REAR PANEL CONNECTIONS

Make sure that power to both the deck and your amplifier/receiver is turned off before making any connections.

- The White plug on the paired connecting cables corresponds to the Left channel and the Red plug corresponds to the Right channel. Make sure that the left and right channel connections are properly made, and that the plugs are inserted firmly.
- The LINE OUT/PLAY jacks on the deck should be connected to the TAPE PB (Playback/Input) jacks on your amplifier/receiver, and the LINE IN/REC jacks on the deck should be connected to the REC OUT (Recording/Output) jacks on your amplifier/receiver.
- The LINE OUT terminals on this unit are numbered 3 and the LINE IN jacks are numbered 4. When connecting this unit to a YAMAHA amplifier or receiver whose terminals are numbered 1, 2, 3, 4 ... (etc.), connect this unit's LINE OUT terminals to the input terminals numbered 3 and connect this unit's LINE IN terminals to the output terminals numbered 4 on the rear panel of the amplifier or receiver.
- Connect the power cord to an AC wall outlet or to an AC outlet on the rear panel of your amplifier/receiver (if provided).

NOTES ON THIS MANUAL

In this manual, the main operation buttons of the front panel are indicated based on DECK B when the operation is common to both DECKs A and B. Since the locations of the buttons of DECK A and DECK B are the same, you can easily find the desired button even when operating DECK A. This manual covers two models. In most cases, however, only model KX-W421 is shown in the example illustrations.

Example: KX-W421

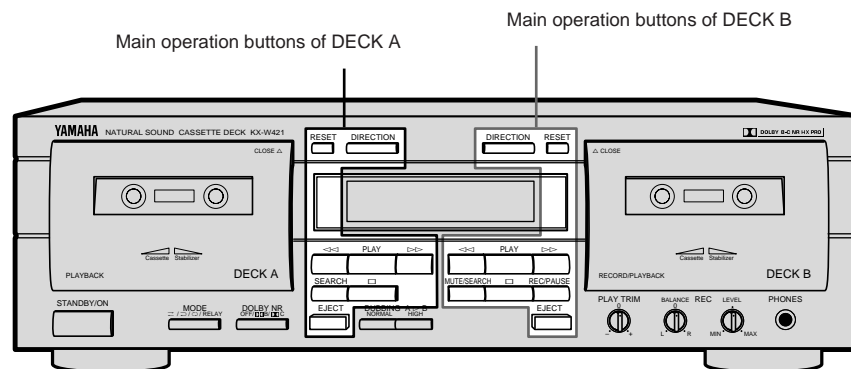

PLAYBACK (Common to DECKS A and B)





Preparation for playback

- Turn on the **STANDBY/ON** switch.
- Set your amplifier or receiver to cassette deck function mode.

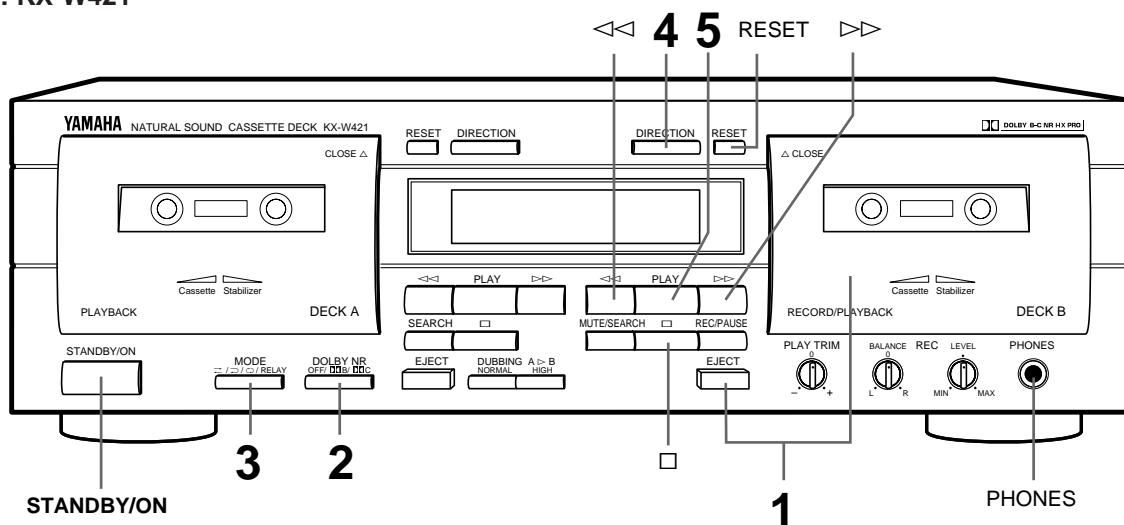
BASIC OPERATION - To play back a cassette tape

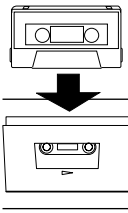
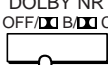
Example: KX-W421



<p>1</p>   <p>Insert the cassette with the exposed tape side facing down. (The side facing you is called the forward side and the opposite side is called the reverse side.) To close the compartment, push the section of the compartment door marked Δ CLOSE until it locks shut.</p>	<p>2</p>  <p>Refer to the following description.</p>
<p>3</p>  <p>Refer to the following description.</p>	<p>4</p>  <p>Select the tape running direction for DECK A or B. Each time this button is pressed, the tape running direction changes between forward (\triangleright) and reverse (\triangleleft), and the corresponding indicator lights on the display.</p>
<p>5</p> 	

To fast forward or rewind the tape

When the tape running indicator \triangleright is lit:

Pressing the $\triangleright\triangleright$ button fast forwards the tape while pressing the $\triangleleft\triangleleft$ button rewinds the tape.

When the tape running indicator \triangleleft is lit:

Pressing the $\triangleleft\triangleleft$ button fast forwards the tape while pressing the $\triangleright\triangleright$ button rewinds the tape.

To stop playback

Press the \square button. To remove the cassette tape, press the **EJECT** button. The cassette compartment door opens. To set the unit to standby mode, press the **STANDBY/ON** button.

To set the counter reading to "0000"

Press the **RESET** button. Use the tape counter to aid in locating a point on a tape (0000 to 9999).

DOLBY NR selector setting (in step 2)

Be sure to set the **DOLBY NR** selector according to the system used for recording.

OFF: For a tape recorded with DOLBY NR OFF.

B: For a tape recorded with DOLBY B NR.

C: For a tape recorded with DOLBY C NR.

REVERSE MODE selector setting (in step 3)

The auto reverse function allows the tape running direction be reversed automatically. Select an auto reverse mode (\rightleftarrows , \rightleftarrows RELAY , or \rightleftarrows) or manual reverse mode (\leftarrow).

\leftarrow : When playback or fast forwarding (or rewinding) of one side of a tape is finished, the deck stops at the end of the tape.

\rightleftarrows : Both sides of the tape are played back. After playing, the deck stops at the end of the tape. (When the tape running direction is set to \leftarrow , only the reverse side is played.)

\rightleftarrows RELAY: Both sides of the tape are repeatedly played back (up to 8 times).

\rightleftarrows RELAY : Cassette tapes loaded in DECKs A and B are played back sequentially. (See "RELAY PLAYBACK" on page 9.)

Display during playback

The A or B indicator shown in the display represents the last deck operated.

KX-W421/
KX-W321

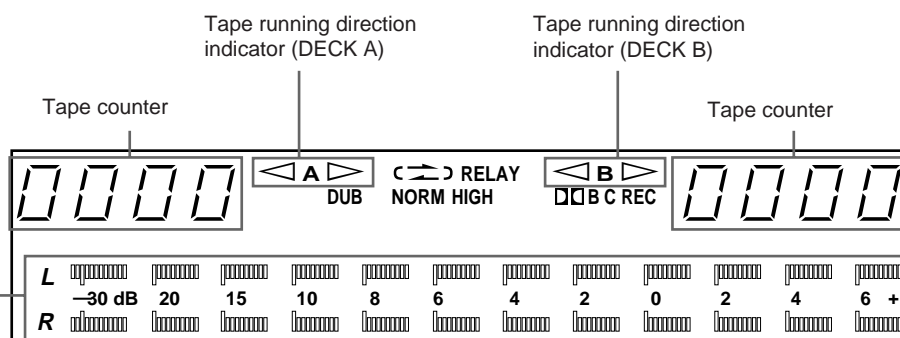

Peak level meters

Indicate the peaks of the signal levels during recording and playback over a -30 dB to +6 dB range. There are separate meters for each left and right channel. These level meters have a peak hold function which holds the peak level for about 1.5 seconds.

To adjust the volume level

Use the volume control of the amplifier or receiver.

Note

Never press the **EJECT** button when the tape is in motion.

To use headphones

Insert the headphones plug into the **PHONES** jack. Since the sound is also heard from the speakers, operate the amplifier to cut off the sound from the speakers for private listening.

Example: KX-W421

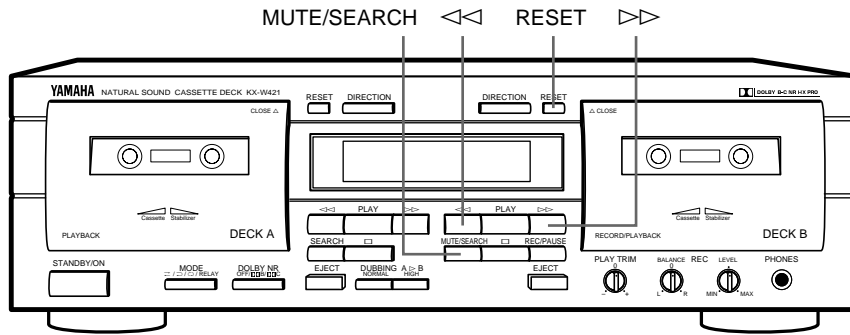

SELECTION SEARCH - To play back a desired selection by searching for the beginning of the selection

To search for the next selection

When the ▷ tape running indicator is lit:

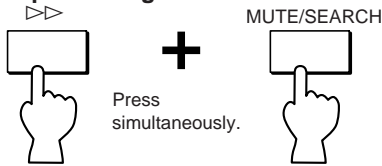

When the ◁ tape running indicator is lit:

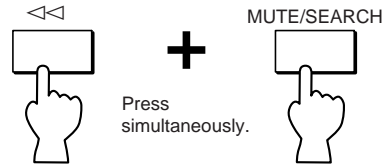

To search for the beginning of the current selection

When the ▷ tape running indicator is lit:

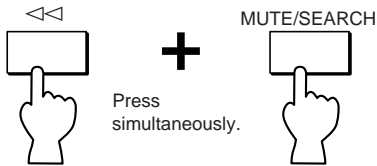

When the ◁ tape running indicator is lit:

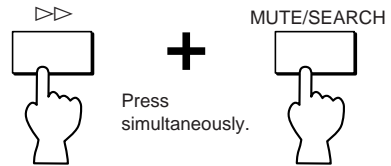

To search for the selection located before the current selection

- Operate the following buttons when the beginning of the current selection is being played.

When the ▷ tape running indicator is lit:

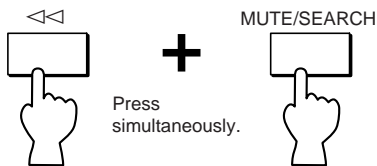

When the ◁ tape running indicator is lit:

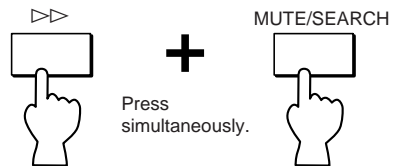

Notes

- The blank interval between selections must be at least 4 seconds long.
- Selection search may not operate properly with tapes recorded at a low recording level or which have excessive noise.

Example: KX-W421

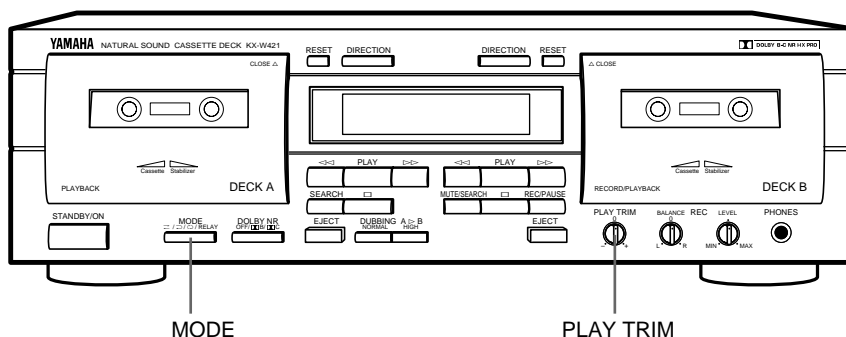

RELAY PLAYBACK - To play DECK A and DECK B sequentially

Load the cassette tapes into DECKS A and B, start playback from DECK A. The playback patterns differ according to the setting of the **MODE** button. Refer to the following.

When the MODE button is set to $\leftarrow \rightarrow$ RELAY :

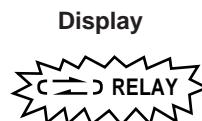
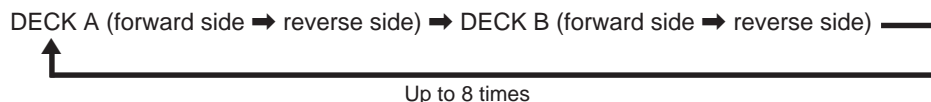

When the MODE button is set to $\leftarrow \rightarrow$:



When the MODE button is set to \rightarrow :



When the MODE button is set to \rightarrow :



PLAY TRIM CONTROL ADJUSTMENT (KX-W421 only)

When the level of high frequencies is either over emphasized or absent while playing a tape recorded on another cassette deck, adjust the high frequency response with the **PLAY TRIM** control.

When high frequencies are too loud, attenuate the high frequencies.

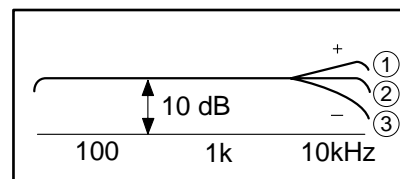

When high frequencies are too soft, boost the high frequencies.



- ① High frequency sound is too loud.
- ② Flat
- ③ High-frequency sound is too soft.

RECORDING



Preparation for recording

- Turn on the **STANDBY/ON** switch.
- Set your amplifier or receiver to cassette deck function mode.

BASIC OPERATION - To record a program source

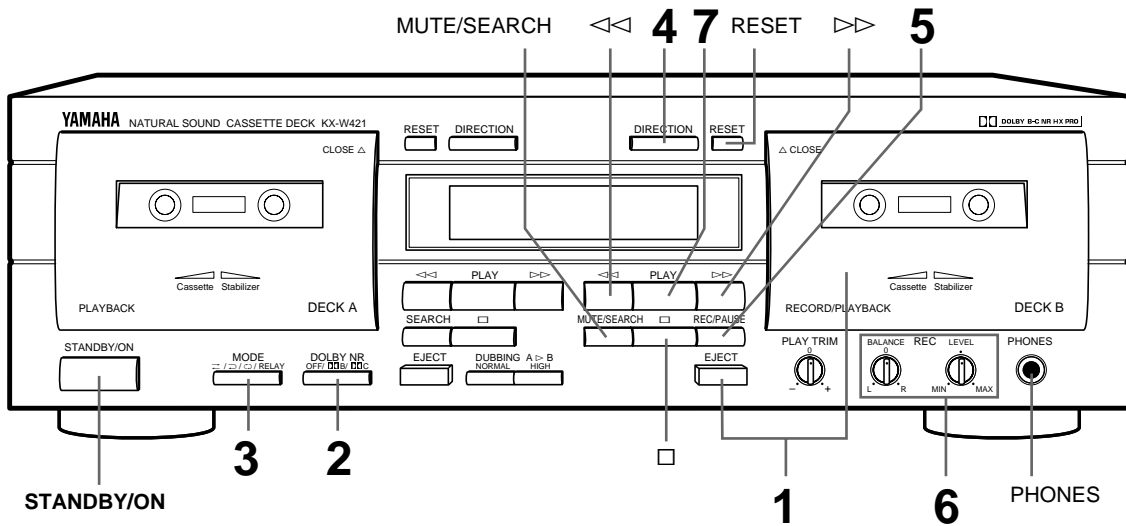
Example: KX-W421

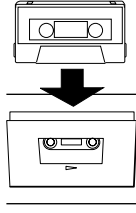
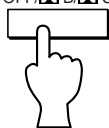
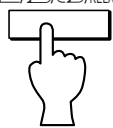

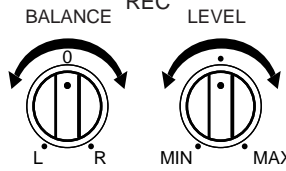
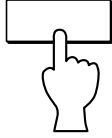
<p>1</p>   <p>Insert the cassette into DECK B with the exposed tape side facing down. (The side facing you is called the forward side and the opposite side is called the reverse side.) To close the compartment, push the section of the compartment door marked Δ CLOSE until it locks shut.</p>	<p>2</p>  <p>Refer to the following description.</p>	<p>3</p>  <p>Refer to the following description.</p>	
<p>4</p>  <p>Select the tape running direction. (Press the DIRECTION button for DECK B.) Each time the button is pressed, the tape running direction changes between forward (\triangleright) and reverse (\triangleleft), and the indicator lights on the display.</p>	<p>5</p>  <p>The REC indicator lights on the display. The deck enters the Rec/Pause mode.</p>	<p>6</p>  <p>Play the program source to be recorded and adjust the recording level and balance. (KX-W321 does not have a REC BALANCE control.)</p>	<p>7</p>  <p>Recording starts.</p>

DOLBY NR selector setting (in step 2)

Set the **DOLBY NR** selector according to your purpose.

OFF: No noise reduction.

□□ B: For recording the sources with Dolby B NR.

□□ C: For recording the sources with Dolby C NR.

- Dolby noise reduction is an extremely effective method of reducing undesirable background hiss on tapes. This unit incorporates both Dolby B NR and the newer Dolby C NR system. Dolby C NR is approximately twice as effective as the earlier Dolby B NR.

REVERSE MODE selector setting (in step 3)

The auto reverse function allows the tape running direction to be reversed automatically. Select the auto reverse mode (↔) or manual reverse mode (↔).

↔: When recording on one side of a tape is finished, the deck stops at the end of the tape.

↔↔: Both sides of a tape are recorded. After recording, the deck stops at the end of the tape.

- When the tape running direction is set to ◀, only the reverse side is recorded.

- If you select C↔↔ or C↔↔ RELAY, the reverse mode automatically switches to ↔↔ in step 5.

Setting the recording level (in step 6)

Play the loudest passage of the source to be recorded and watch the meter readings.

Adjust the **REC LEVEL** control so that the highest peak reaches +4 of the optimum recording level. Normally, it is best to adjust the **REC BALANCE** control (KX-W421 only) such that the left and right meter readings are even.

Display during recording

The A or B indicator shown in the display represents the last deck operated.

Tape counter

Use the tape counter to aid in locating a point on a tape (0000 to 9999).

To set the counter reading to "0000", press the **RESET** button.

KX-W421/
KX-W321

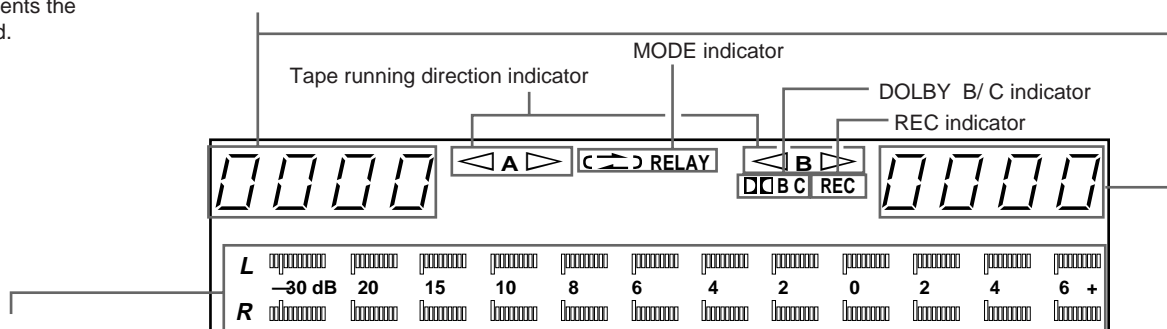

Peak level meters

Indicate the peaks of the signal levels during recording and playback over a -30 dB to +6 dB range. There are separate meters for each left and right channel. These level meters have a peak hold function which holds the peak level for about 1.5 seconds.

To stop recording:

Press the □ button.

To stop recording temporarily:

Press the **REC/PAUSE** button. To resume recording, press the **PLAY** button.

Example: KX-W421

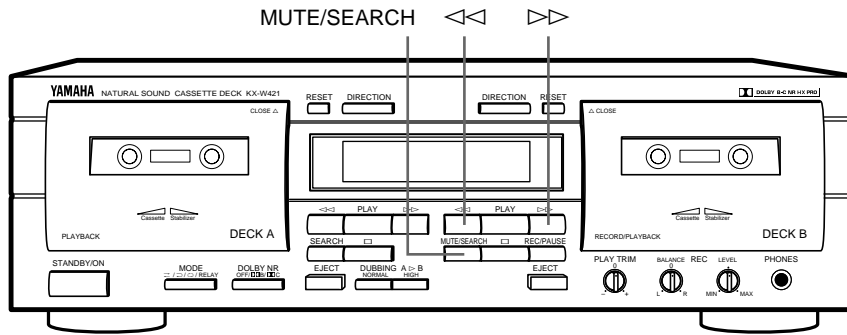

REC MUTE OPERATION - Inserting a blank space during recording

During recording:



During Rec mute operation, the REC indicator blinks.

A 4-second blank interval is automatically recorded on the tape and then the deck enters Rec/Pause mode. If a blank interval longer than 4 seconds is desired, keep pressing for as long as you want. When the **MUTE/SEARCH** button is released, the deck enters Rec/Pause mode after making a 4-second blank interval. To resume recording, press the **PLAY** button.

- If a blank interval shorter than 4 seconds is desired, press the **PLAY** button at the desired point during Rec mute mode. Recording will be resumed from that point.

REC RETURN OPERATION - To return to the point at which the recording started

During recording:

When the ▷ indicator is lit:

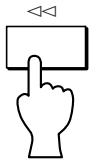

When the ◀ indicator is lit:



- If you press the **PLAY** button during recording, Rec Return automatically rewinds the tape to the point where the **PLAY** button was pressed.* If you reset the tape counter to "0000" during recording, Rec Return automatically rewinds the tape to the "0000" point. Rec Return functions according to the most recent operation. For example, if you reset the tape counter to "0000" and then press the **PLAY** button later, Rec Return rewinds to the point where the **PLAY** button was pressed.

* The **PLAY** button cannot be used to mark a return point while dubbing.

DOLBY HX PRO DYNAMIC BIAS SERVO SYSTEM (KX-W421 only)

This unit incorporates the Dolby HX Pro system which automatically controls the effective bias to reduce distortion and noise, improving high frequency response during recording. Tapes recorded with this system retain the same high quality even when played back on any other cassette deck.

Synchronized recording function

When operating this unit in combination with the YAMAHA CD Player which has SYNCHRO button on its remote control transmitter, CD Synchronized recording function can be utilized. This function is operated with the remote control transmitter of the CD Player. (Regarding the operation, refer to the manual of the CD Player.)

DUBBING (From DECK A to DECK B)

You can make dubbing from DECK A to DECK B. Open the cassette compartments by pressing the **EJECT** buttons and load a blank cassette tape in DECK B and the original cassette tape in DECK A.

Example: KX-W421

Display during dubbing

NORM or HIGH indicator lights during dubbing.

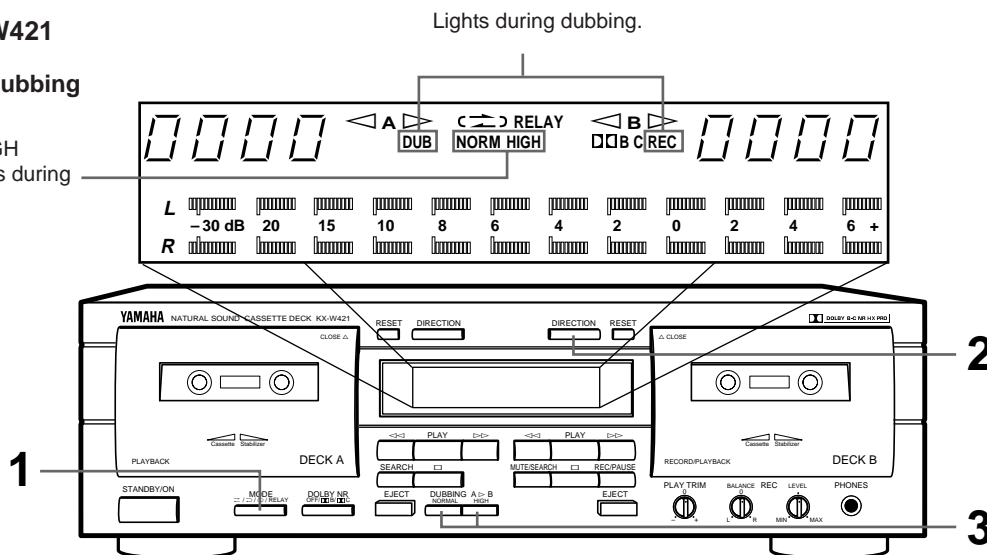

1 Set the **MODE** selector to \Rightarrow or \Rightarrow position. If you select \Leftarrow or \Leftarrow RELAY, the reverse mode automatically switches to \Rightarrow .



2 Set the **DIRECTION** buttons for DECKs A and B.



3 Set the dubbing speed to either **NORMAL** (normal speed) or **HIGH** (twice the normal speed) with the **DUBBING** buttons*. Dubbing starts automatically.

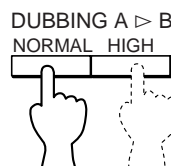

The corresponding NORM or HIGH indicator lights on the display.

* Higher quality sound will be obtained with the NORMAL setting.

To stop dubbing

Press the \square button. (If you press the \square button on DECK B, both decks stop simultaneously and the dubbing mode is cancelled. If you press the \square button on DECK A, DECK A stops immediately and then DECK B stops after recording a 4-second blank section.)

When the tape in DECK B reaches its end, DECK B stops and then DECK A stops.

When the tape in DECK A reaches its end, DECK A stops and DECK B stops after providing a blank section of about 4 seconds.

Available operations while dubbing

The Rec Return function can be carried out on DECK B. Refer to "REC RETURN OPERATION" on the previous page.

Note

During dubbing, Dolby NR is automatically set to off and the recorded tape can be dubbed as is. (When the tape to be dubbed is recorded with Dolby NR, this effect is also dubbed.)

PLAY TRIM control adjustment (KX-W421 only)

For normal use, set the **PLAY TRIM** control to the center position.

When the high frequencies sound is too noticeable or too weak while monitoring the sound of DECK B, compensate the high frequency response with the **PLAY TRIM** control before dubbing. The compensated sound can be dubbed onto DECK B.

As the compensation result depends on the quality of the tape loaded in DECK A, the monitored sound cannot be recorded as it is.

Refer to "PLAY TRIM CONTROL ADJUSTMENT" on page 9.

CASSETTE TAPES

CASSETTE TAPES

There are many different types of cassette tapes available. However, they all conform to standard specifications so any brand may be used with the deck.

- **Classification of Cassette Tapes by Formulation:**

Cassette tapes are available in four basic types depending on their formulation, or type of magnetic material and manufacturing process. These four types are commonly known as Normal (Type I/NORM), Chrome (Type II/HIGH $\langle CrO_2 \rangle$), Ferrichrome (Type III/FeCr), and Metal (Type IV/METAL), and they each require specific tape deck adjustments for optimum performance.

- * YAMAHA does not recommend the use of 120 minute length cassettes since the extreme thinness of the tape makes them susceptible to mechanical and recording problems.

AUTO TAPE SELECTOR DETECTION SLOTS

The deck has a built-in Auto Tape Selector which automatically adjusts for the proper bias, level and equalization according to the tape formulation — all you have to do is to load a cassette and the Auto Tape Selector does the rest.

The Auto Tape Selector determines which type of tape is loaded by sensing detector slots in the top of the tape shell. Each tape formulation has its own characteristic hole markings standardized by the tape industry.

- Early model Metal (Type IV/Metal) tape formulation cassette shells do not have the slots for Auto Tape Selector operation. As a result, early model Metal type tapes recorded on another deck will be played back with the deck at the Chrome (Type II/HIGH $\langle CrO_2 \rangle$) settings. YAMAHA does not recommend using this kind of tape.
- The deck does not have the required setting for Ferrichrome (Type III/FeCr) tape, since this tape formulation is not widely used. Should you use a Ferrichrome tape, it will be recorded and played back at the Normal (Type I/NORM) settings, which will result in an unnatural high frequency emphasis. This effect may be compensated for somewhat by adjusting the PLAY TRIM control and/or the tone controls of your amplifier/receiver during playback.

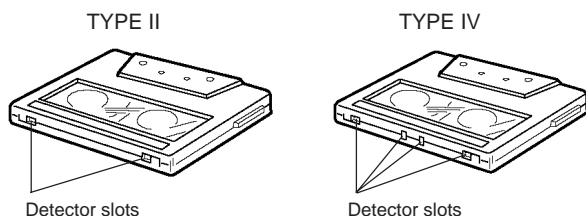

PROTECTING YOUR RECORDINGS

All cassette tapes are provided with erasure protection holes to prevent accidental erasure of recorded contents. There is a small tab covering the hole on each side of the cassette, and it should be broken off after recording the tape. Without this tab covering the hole, it is impossible to record onto that tape. Thus, you can safely protect a recording for as long as you wish without fear of accidental erasure. Should you wish to use a cassette tape protected in this way for recording, simply covering the hole with adhesive tape will permit erasure and re-recording.

- When using Chrome (Type II/HIGH $\langle CrO_2 \rangle$) or Metal (Type IV/METAL) tapes, make sure you do not cover the hole intended for the Auto Tape Selector operation.

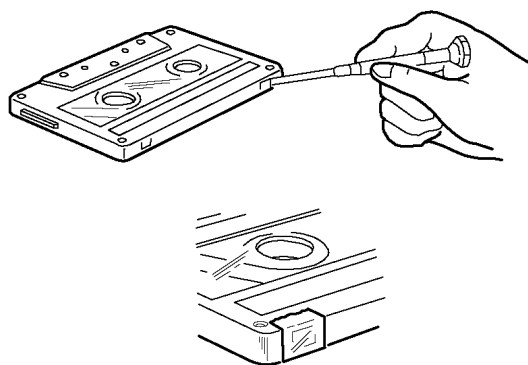

TAKING UP SLACK IN THE TAPE

As a precaution against tape entanglement and damage, remove any slack in the tape before inserting cassettes into the deck. This is accomplished by inserting a pencil, pen or similar object into one of the spools and gently winding it until all the slack is removed. You do not have to wind it too tightly.

Be careful not to touch the tape part itself. It is very delicate and touching it may damage the tape and its recorded contents.

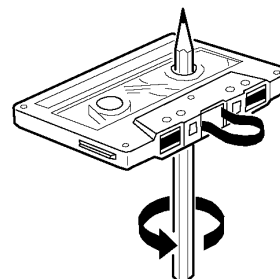

STORING CASSETTES

After putting a cassette tape back into its case, store it in a location away from exposure to direct sunlight, humidity, high temperatures, and magnetic fields (away from television sets, speakers, etc.). High temperatures and humidity will damage the tape itself, while exposure to magnetic fields may cause a loss of recorded material. Avoid touching the tape surface with your fingers, since dirt or finger oil will contaminate the deck's heads.

MAINTENANCE

CLEANING OF THE TAPE PATH

Continued high quality performance of your deck is dependent upon periodic cleaning of the heads, capstan, pinch roller, and all surfaces over which the tape travels. Normal use will cause an accumulation of dirt and dust on the heads, capstans, and pinch rollers. This can lead to poor sound quality, drop outs (intervals with no sound), unsteady tape speed, loss of high frequency response, etc. Thus, clean the heads and all surfaces over which the tape travels with a commercially available cleaning cassette and fluid type cleaner.

DECK B

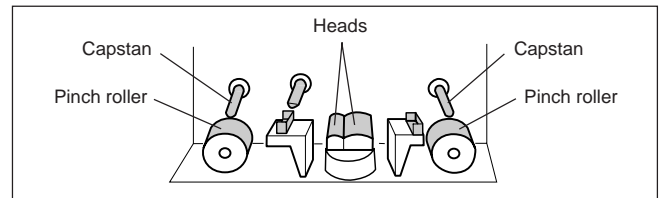

DEMAGNETIZATION

After 20-30 hours of use, enough residual magnetism will build up on the heads to cause poor high frequency reproduction. At this time you should use a commercially available cassette tape-type head demagnetizer.

- When cleaning the tape path or demagnetizing the heads, be sure to follow carefully the instructions of the concerning materials such as cleaning fluid or head demagnetizer.

OPTIONAL REMOTE CONTROL TRANSMITTER

With the optional remote control transmitter RKX1, you can operate this unit at your listening position. For details, refer to the instruction manual supplied with the remote control transmitter.

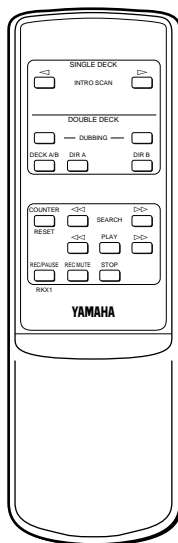

REMOTE CONTROL OPERATION RANGE

Example: KX-W421

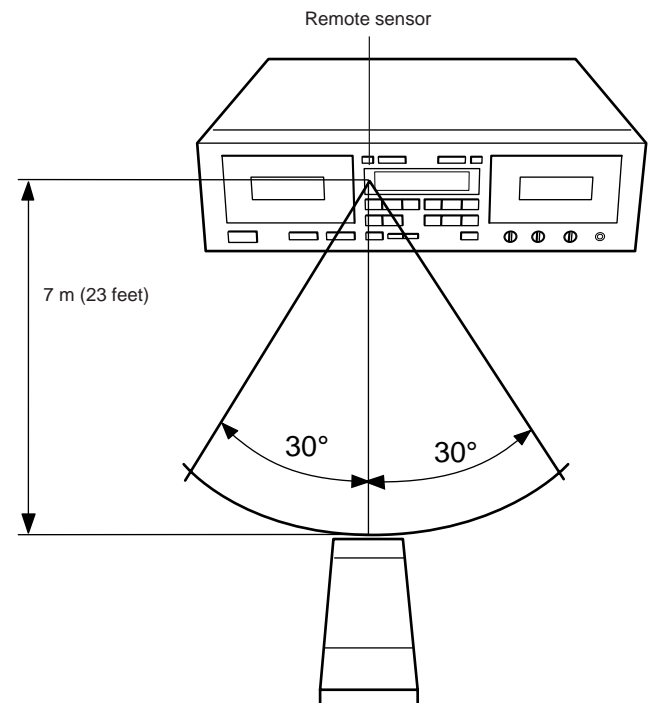

TROUBLESHOOTING

If your cassette deck fails to operate normally, check the following table. It lists common operating errors and simple measures which you can take to correct the problem. If it cannot be corrected, or the symptom is not listed, disconnect the deck's power cord and contact your authorized YAMAHA dealer or authorized service center for help.

Fault	Cause	Cure
Tape doesn't move in recording or playback.	<ul style="list-style-type: none"> ● Power plug is not properly plugged in. ● Cassette shell is warped or damaged. 	<ul style="list-style-type: none"> ● Reinsert plug properly. ● Do not play damaged tapes.
If it happens that this unit does not work normally.	<ul style="list-style-type: none"> ● There is an influence of strong external noise (lightning, excessive static electricity, etc.) or a misoperation was performed while using this unit. 	<ul style="list-style-type: none"> ● Turn the unit off and disconnect the AC power from the AC outlet. After about 30 seconds have passed, connect the power and try again.
REC/PAUSE button fails to function.	<ul style="list-style-type: none"> ● No cassette tape loaded. ● Protective tabs are broken off. 	<ul style="list-style-type: none"> ● Load a cassette tape. ● Change tape or cover protective hole with adhesive tape.
Sounds become faint and sometimes inaudible.	<ul style="list-style-type: none"> ● Head is dirty. ● Head is magnetized. ● Tape is damaged or of poor quality. 	<ul style="list-style-type: none"> ● Clean head. ● Demagnetize head using head demagnetizer. ● Change to a different tape.
Recorded sound is distorted.	<ul style="list-style-type: none"> ● Tape is bad (stretched, deformed, etc.). ● Cassette shell is warped. ● Recording level is too high. 	<ul style="list-style-type: none"> ● Replace with a fresh tape. ● A warped cassette shell cannot be fixed. Replace with another tape and test. ● Check input level with signal level meter and use lower rec level when recording.
Tape is playing back, but no sound is heard.	<ul style="list-style-type: none"> ● Faulty connection between deck and stereo amplifier/receiver. 	<ul style="list-style-type: none"> ● Check and secure connections.
Excessive noise.	<ul style="list-style-type: none"> ● Head is dirty. ● Head is magnetized. ● Worn out or poor quality tape. ● Connection(s) improperly made. ● Affected by external electrical noise. 	<ul style="list-style-type: none"> ● Clean head. ● Demagnetize head with head demagnetizer. ● Change to better tape. ● Check input and output connections and reinsert properly. ● Move deck away from electrical appliances (TV, fluorescent light, electric blanket, etc.).
Excessive wow (wavering of the sound).	<ul style="list-style-type: none"> ● Dirty capstan, pinch roller, etc., or poor tape. ● Tape is wound unevenly. 	<ul style="list-style-type: none"> ● Clean capstan and pinch roller, or change to better tape. ● Rewind tape.
Tape stops in the middle of recording or playback.	<ul style="list-style-type: none"> ● Slack tape, or tape spillage wound around capstan. 	<ul style="list-style-type: none"> ● Insert pencil in hole in cassette shell and turn to take up slack.
Fails to record.	<ul style="list-style-type: none"> ● REC LEVEL control is set to too low. ● Protective tabs are broken off. 	<ul style="list-style-type: none"> ● Adjust REC LEVEL control. ● Change tape or cover protective hole with adhesive tape.
Search does not operate correctly.	<ul style="list-style-type: none"> ● Blank section is too short. ● Recorded section has low-level portions. ● Conversation, etc. has been recorded. 	<ul style="list-style-type: none"> ● Blank sections must be at least 4 seconds long. ● No remedy ● No remedy
High frequencies in the playback sound are emphasized and unpleasant to listen to, and noise level (hiss) is also high.	<ul style="list-style-type: none"> ● Dolby NR-recorded tape is played back in OFF position. 	<ul style="list-style-type: none"> ● Play back in appropriate Dolby NR position.

Fault	Cause	Cure
Playback sound is muffled and high frequencies are inaudible.	<ul style="list-style-type: none"> ● Normally-recorded tape is played back in Dolby NR. ● Heads are dirty. ● Heads are magnetized. 	<ul style="list-style-type: none"> ● Play back in OFF position. ● Clean heads and carry out demagnetization with head demagnetizer.
When playing back tapes recorded on other decks, meter deflections are greater (smaller) than when recorded.	<ul style="list-style-type: none"> ● Basic levels are different for different cassette decks. 	<ul style="list-style-type: none"> ● This is not a fault.
The remote control transmitter cannot be operated.	<ul style="list-style-type: none"> ● The batteries are exhausted. ● The remote control transmitter is operated from an incorrect distance or angle. ● The remote control sensor is lighted strongly. 	<ul style="list-style-type: none"> ● Replace batteries. ● Operate it from less than 7 meters (about 23 ft.) and 30°. ● Place the unit away from the strong light.

SPECIFICATIONS

Type Auto reverse 4-track, 2-channel recording and playback stereo double cassette deck

Motors DC servo motor x 2 (main)

Heads Recording/playback: Hard Permalloy x 1
Erase: Double-gap Ferrite x 1
Playback: Hard Permalloy x 1

Rapid Transport 100 sec. (C-60)

Wow and Flutter

WRMS 0.08%

W.Peak ±0.15%

Signal-to-Noise Ratio

(Dolby NR off) 58 dB

(Dolby B NR on) 66 dB

(Dolby C NR on) 74 dB

Frequency Response (-20 dB)

<KX-W421>

Type I/Normal 20 ~ 17,000 Hz ±3 dB

Type II/High (CrO₂) 20 ~ 18,000 Hz ±3 dB

Type IV/Metal 20 ~ 20,000 Hz ±3 dB

<KX-W321>

Type I/Normal 20 ~ 16,000 Hz ±3 dB

Type II/High (CrO₂) 20 ~ 17,000 Hz ±3 dB

Type IV/Metal 20 ~ 19,000 Hz ±3 dB

Harmonic Distortion

KX-W421 less than 0.8%

KX-W321 less than 1.0%

Input Sensitivity/Impedance

Line 100 mV/43 k-ohms

Output Level

Line 570 mV/1.4 k-ohms

Phones 0.25 mV/8 ohms

Channel Separation (1 kHz) more than 40 dB

Crosstalk (125 Hz) more than 55 dB

GENERAL

Power Supply

U.S.A. and Canada model 120 V, 60 Hz

Europe and U.K. model 230 V, 50 Hz

Australia model 240 V, 50 Hz

General model 110/120/220/240 V, 50/60 Hz

Power Consumption

KX-W421 14 W/7 W (Standby)

KX-W321

U.S.A. and Canada model 11 W/7 W (Standby)

Other models 12 W/7 W (Standby)

Dimensions (W x H x D) 435 x 146 x 279 mm
(17-1/8" x 5-3/4" x 11")

Weight 5.0 kg (11 lbs.)

Accessory

Audio cord 1 pair

* Specifications subject to change without notice.

Problème	Cause	Remède
Le son de lecture est étouffé et les hautes fréquences sont inaudibles.	<ul style="list-style-type: none"> ● Une bande enregistrée normalement est lue avec Dolby NR. ● Les têtes sont sales. ● Les têtes sont magnétisées. 	<ul style="list-style-type: none"> ● Lire en position OFF. ● Nettoyer les têtes et effectuer la démagnétisation avec un démagnétiseur de tête.
Lors de la lecture de bandes enregistrées sur d'autres platines, les déflexions du compteur sont plus grandes (plus petites) qu'à l'enregistrement.	<ul style="list-style-type: none"> ● Les niveaux de base sont différents pour diverses platines. 	<ul style="list-style-type: none"> ● Ceci n'est pas un défaut.
La télécommande ne fonctionne pas.	<ul style="list-style-type: none"> ● La pile est déchargée. ● La télécommande est actionnée d'une distance ou sous un angle incorrects. ● Le détecteur de la télécommande est fortement éclairé. 	<ul style="list-style-type: none"> ● Remplacer la pile. ● La faire fonctionner à moins de 7 mètres et sur 30°. ● Placer l'appareil à l'abri de lumières fortes.

CARACTERISTIQUES TECHNIQUES

Configuration des pistes	Platine à cassette double stéréo avec inversion automatique pour l'enregistrement et la lecture, 4 pistes, 2 canaux
Moteur	Moteur asservi CC x 2 (moteurs principaux)
Têtes	Enregistrement/Lecture: Permalloy dur x 1 Effacement: Ferrite à double entrefer x 1 Lecture: Permalloy dur x 1
Transport rapide	100 secondes (C-60)
Pleurage et scintillement	
Eff., pondéré	0,08%
Crête, pondéré	±0,15%
Rapport signal/bruit	
(Dolby NR à l'arrêt)	58 dB
(Dolby B NR en marche)	66 dB
(Dolby C NR en marche)	74 dB
Réponse en fréquence (-20dB)	
<KX-W421>	
Type I/normale	20 ~ 17.000 Hz ±3 dB
Type II/élevée (CrO₂)	20 ~ 18.000 Hz ±3 dB
Type IV/métal	20 ~ 20.000 Hz ±3 dB
<KX-W321>	
Type I/normale	20 ~ 16.000 Hz ±3 dB
Type II/élevée (CrO₂)	20 ~ 17.000 Hz ±3 dB
Type IV/métal	20 ~ 19.000 Hz ±3 dB
Distorsion harmonique	
KX-W421	Moins de 0,8%
KX-W321	Moins de 1,0%
Sensibilité d'entrée/impédance	
Ligne	100 mV/43 k-ohms
Niveau de sortie	
Ligne	570 mV/1,4 k-ohms
Casque	0,25 mV/8 ohms
Séparation des canaux (1 kHz)	inférieure à 40 dB
Diaphonie (125 Hz)	inférieure à 55 dB

GENERALES

Alimentation

Modèle pour les Etats-Unis et le Canada

..... 120 V, 60 Hz

Modèle pour l'Europe et le Royaume-Uni

..... 230 V, 50 Hz

Modèle pour l'Australie

..... 240 V, 50 Hz

Modèle général

..... 240 V, 50/60 Hz

Consommation

KX-W421 14 W/7 W (Veille)

KX-W321

Modèle pour les Etats-Unis et le Canada

..... 11 W/7 W (Veille)

Autres modèles

..... 12 W/7 W (Veille)

Dimensions (L x H x P) 435 x 146 x 279 mm

Poids 5,0 kg

Câbles audio 1 paire

* Les caractéristiques techniques sont sujettes à des changements sans préavis.

YAMAHA ELECTRONICS CORPORATION, USA 6660 ORANGETHORPE AVE., BUENA PARK, CALIF. 90620, U.S.A.
YAMAHA CANADA MUSIC LTD. 135 MILNER AVE., SCARBOROUGH, ONTARIO M1S 3R1, CANADA
YAMAHA ELECTRONIK EUROPA G.m.b.H. SIEMENSSTR. 22-34, 25462 RELLINGEN, BEI HAMBURG, F.R. OF GERMANY
YAMAHA ELECTRONIQUE FRANCE S.A. RUE AMBROISE CROIZAT BP70 CROISSY-BEAUBOURG 77312 MARNE-LA-VALLEE CEDEX02, FRANCE
YAMAHA ELECTRONICS (UK) LTD. YAMAHA HOUSE, 200 RICKMANSWORTH ROAD WATFORD, HERTS WD1 7JS, ENGLAND
YAMAHA SCANDINAVIA A.B. J A WETTERGRENS GATA 1, BOX 30053, 400 43 VASTRA FRÖLUNDA, SWEDEN
YAMAHA MUSIC AUSTRALIA PTY, LTD. 17-33 MARKET ST., SOUTH MELBOURNE, 3205 VIC., AUSTRALIA

YAMAHA CORPORATION

Printed in Malaysia

VZ 79000-1