



RX-E100 / CDX-E100

Natural Sound Stereo Receiver/Natural Sound Compact Disc Player

Récepteur Stéréo/Lecteur Compact Disque

COMPACT
disc
DIGITAL AUDIO

COMPACT
disc
DIGITAL AUDIO
TEXT

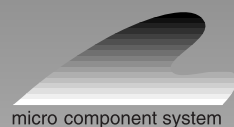

micro component system

PIANOCRAFT

COMPACT
disc
DIGITAL AUDIO
TEXT



**OWNER'S MANUAL
MODE D'EMPLOI**

SAFETY INSTRUCTIONS

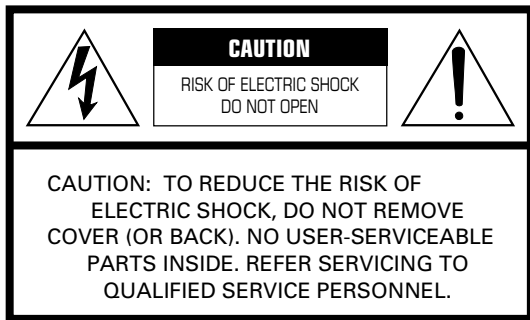

• Explanation of Graphical Symbols

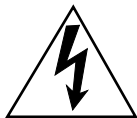

The lightning flash with arrowhead symbol, within an equilateral triangle, is intended to alert you to the presence of uninsulated “dangerous voltage” within the product’s enclosure that may be of sufficient magnitude to constitute a risk of electric shock to persons.



The exclamation point within an equilateral triangle is intended to alert you to the presence of important operating and maintenance (servicing) instructions in the literature accompanying the appliance.

WARNING
TO REDUCE THE RISK OF FIRE OR ELECTRIC SHOCK, DO NOT EXPOSE THIS UNIT TO RAIN OR MOISTURE.

IMPORTANT!
Please record the serial number of this unit in the space below.

Model:
Serial No.:

The serial number is located on the rear of the unit. Retain this Owner’s Manual in a safe place for future reference.

- 1 Read Instructions – All the safety and operating instructions should be read before the unit is operated.
- 2 Retain Instructions – The safety and operating instructions should be retained for future reference.
- 3 Heed Warnings – All warnings on the unit and in the operating instructions should be adhered to.
- 4 Follow Instructions – All operating and other instructions should be followed.
- 5 Water and Moisture – The unit should not be used near water – for example, near a bathtub, washbowl, kitchen sink, laundry tub, in a wet basement, or near a swimming pool, etc.
- 6 Carts and Stands – The unit should be used only with a cart or stand that is recommended by the manufacturer.



- 6A A unit and cart combination should be moved with care. Quick stops, excessive force, and uneven surfaces may cause the unit and cart combination to overturn.
- 7 Wall or Ceiling Mounting – The unit should be mounted to a wall or ceiling only as recommended by the manufacturer.
- 8 Ventilation – The unit should be situated so that its location or position does not interfere with its proper ventilation. For example, the unit should not be situated on a bed, sofa, rug, or similar surface, that may block the ventilation openings; or placed in a built-in installation, such as a bookcase or cabinet that may impede the flow of air through the ventilation openings.
- 9 Heat – The unit should be situated away from heat sources such as radiators, stoves, or other appliances that produce heat.
- 10 Power Sources – The unit should be connected to a power supply only of the type described in the operating instructions or as marked on the unit.
- 11 Power-Cord Protection – Power-supply cords should be routed so that they are not likely to be walked on or pinched by items placed upon or against them, paying particular attention to cords at plugs, convenience receptacles, and the point where they exit from the unit.
- 12 Cleaning – The unit should be cleaned only as recommended by the manufacturer.
- 13 Nonuse Periods – The power cord of the unit should be unplugged from the outlet when left unused for a long period of time.
- 14 Object and Liquid Entry – Care should be taken so that objects do not fall into and liquids are not spilled into the inside of the unit.
- 15 Damage Requiring Service – The unit should be serviced by qualified service personnel when:
 - A. The power-supply cord or the plug has been damaged; or
 - B. Objects have fallen, or liquid has been spilled into the unit; or
 - C. The unit has been exposed to rain; or
 - D. The unit does not appear to operate normally or exhibits a marked change in performance; or
 - E. The unit has been dropped, or the cabinet damaged.
- 16 Servicing – The user should not attempt to service the unit beyond those means described in the operating instructions. All other servicing should be referred to qualified service personnel.
- 17 Power Lines – An outdoor antenna should be located away from power lines.
- 18 Grounding or Polarization – Precautions should be taken so that the grounding or polarization is not defeated.

19 For U.S. customers only:

Outdoor Antenna Grounding – If an outside antenna is connected to this unit, be sure the antenna system is grounded so as to provide some protection against voltage surges and built-up static charges. article 810 of the National Electrical Code, ANSI/NFPA 70, provides information with regard to proper grounding of the mast and supporting structure, grounding of the lead-in wire to an antenna discharge unit, connection to grounding electrodes, and requirements for the grounding electrode.

Note to CATV system installer:

This reminder is provided to call the CATV system installer's attention to Article 820-40 of the NEC that provides guidelines for proper grounding and, in particular, specifies that the cable ground shall be connected to the grounding system of the building, as close to the point of cable entry as practical.

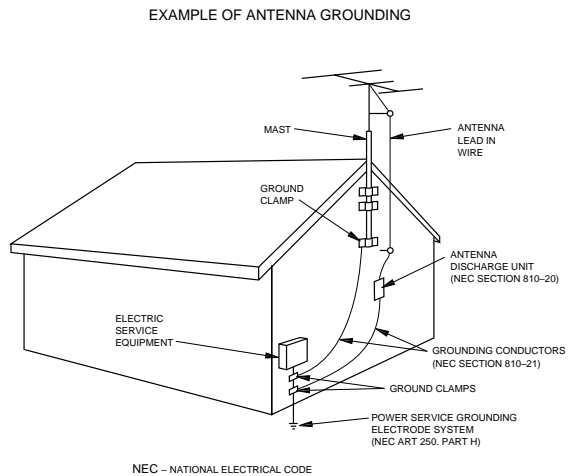

FCC INFORMATION (for US customers only)

1. IMPORTANT NOTICE: DO NOT MODIFY THIS UNIT!

This product, when installed as indicated in the instructions contained in this manual, meets FCC requirements. Modifications not expressly approved by Yamaha may void your authority, granted by the FCC, to use the product.

2. IMPORTANT:

When connecting this product to accessories and/or another product use only high quality shielded cables. Cable/s supplied with this product MUST be used. Follow all installation instructions. Failure to follow instructions could void your FCC authorization to use this product in the USA.

3. NOTE:

This product has been tested and found to comply with the requirements listed in FCC Regulations, Part 15 for Class "B" digital devices. Compliance with these requirements provides a reasonable level of assurance that your use of this product in a residential environment will not result in harmful interference with other electronic devices.

This equipment generates/uses radio frequencies and, if not installed and used according to the instructions found in the users manual, may cause interference harmful to the operation of other electronic devices.

Compliance with FCC regulations does not guarantee that interference will not occur in all installations. If this product is found to be the source of interference, which can be determined by turning the unit "OFF" and "ON", please try to eliminate the problem by using one of the following measures:

Relocate either this product or the device that is being affected by the interference.

Utilize power outlets that are on different branch (circuit breaker or fuse) circuits or install AC line filter/s.

In the case of radio or TV interference, relocate/reorient the antenna. If the antenna lead-in is 300 ohm ribbon lead, change the lead-in to coaxial type cable.

If these corrective measures do not produce satisfactory results, please contact the local retailer authorized to distribute this type of product. If you can not locate the appropriate retailer, please contact Yamaha Electronics Corp., U.S.A. 6660 Orangethorpe Ave, Buena Park, CA 90620.

The above statements apply ONLY to those products distributed by Yamaha Corporation of America or its subsidiaries.

We Want You Listening For A Lifetime

YAMAHA and the Electronic Industries Association's Consumer Electronics Group want you to get the most out of your equipment by playing it at a safe level. One that lets the sound come through loud and clear without annoying blaring or distortion – and, most importantly, without affecting your sensitive hearing. Since hearing damage from loud sounds is often undetectable until it is too late, YAMAHA and the Electronic Industries Association's Consumer Electronics Group recommend you to avoid prolonged exposure from excessive volume levels.



SUPPLIED ACCESSORIES
ACCESSOIRES FOURNIS

- After unpacking, check that the following parts are contained.
- Après le déballage, vérifier que les pièces suivantes sont incluses.

<RX-E100>

- Remote control
- Télécommande

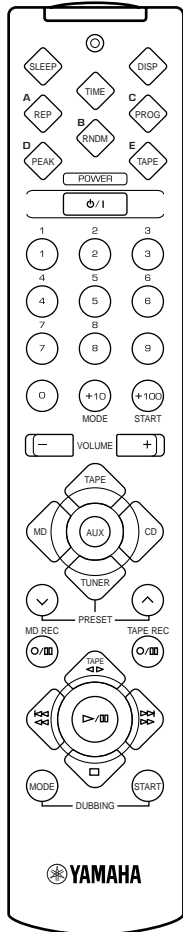

- AM loop antenna
- Antenne cadre AM

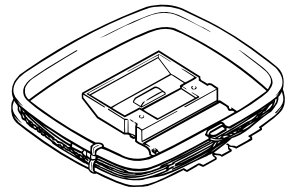

- Indoor FM antenna
- Antenne intérieure FM

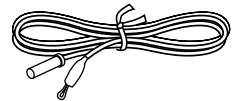

- Batteries (size AAA, UM-4, R03)
- Piles (format AAA, UM-4, R03)

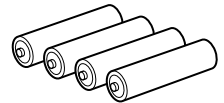

<CDX-E100>

- RCA Pin Cable
- Câble de raccordement RCA

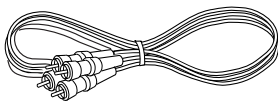

- System Control Cable
- Câble de commande du système



INTRODUCTION

Thank you for purchasing this YAMAHA product. We hope it will give you many years of trouble-free enjoyment. For the best performance, read this manual carefully. It will guide you in operating your YAMAHA product.

FEATURES

<RX-E100>

- **Minimum RMS Output Power per Channel**
40 W + 40 W (6Ω, 20 - 20,000Hz, 0.1% THD)
- **Full Operation System Remote Control**
- **40-Station FM/AM Preset Tuning**
- **SUBWOOFER Output Terminal**

<CDX-E100>

- **S-bit DAC and 8fs Digital Filter**
- **Optical Digital Output**
- **Random, Repeat, and Program Play**
- **CD TEXT Display**
- **Peak Level Search**
- **Tape Programming**

The receiver (RX-E100) and CD player (CDX-E100) are the main units of the YAMAHA E100 series. You could upgrade the system by adding the cassette deck (KX-E100) and MD recorder (MDX-E100)*.

*MD recorder (MDX-E100) may not be available for some areas.

CONTENTS

PRECAUTIONS	2
GETTING STARTED	
The remote control	3
Connecting the speakers	4
Connecting the system	5
<RX-E100>	
NAMES OF BUTTONS AND CONTROLS	6
BASIC OPERATIONS	
Listening to a source	8
TUNER OPERATIONS	
Listening to the radio	9
Presetting stations	10
USING THE BUILT-IN TIMER	
Setting the clock	11
Adjusting the brightness of the display	11
Before using the timer	12
Timer play and recording	12
Sleep timer	13

<CDX-E100>	
NAMES OF BUTTONS AND CONTROLS	14
COMPACT DISC PLAYER OPERATIONS	
CD playback	16
Selecting the time display and CD TEXT	17
Random-sequence play	17
Repeat play	18
Program play	18
Peak level search	19
ADD KX-E100 AND/OR MDX-E100 TO YOUR SYSTEM	
Operating the cassette deck, KX-E100 and MD recorder, MDX-E100 with the remote control ...	20
Before recording	21
Dubbing setting	21
TAPE programming	22
ADDITIONAL INFORMATION	
CD preventive care	23
Troubleshooting	23
Specifications	25

PRECAUTIONS: READ THIS BEFORE OPERATING THE UNIT

CAUTIONS

- To assure the finest performance, please read this manual carefully. Keep it in a safe place for future reference.
- Install your unit in a well ventilated, cool, dry, clean place – away from windows, heat sources, vibration, dust, moisture, or cold. To avoid humming sounds, locate the unit away from other electrical appliances, motors, and transformers. To prevent fire or electrical shock, do not expose to rain and water.
- (U.K. and Europe models only)
Be sure to allow at least 10 cm of ventilation space at the top, on left, right, and back sides of RX-E100.
- Do not operate the unit upside-down. It may overheat, possibly causing damage.
- Never open the cabinet. If something drops into the set, contact your dealer.
- Do not use force on switches, knobs or cords.
- Always set the VOLUME control to minimum before starting playback of an audio source: increase the volume gradually to an appropriate level after play has started.
- When not planning to use this unit for long periods of time (i.e., vacation, etc.), disconnect the AC power plug from the wall outlet.
- Grounding or polarization – Precautions should be taken so that the grounding or polarization of the unit is not defeated.
- Do not clean the unit with chemical solvents; this might damage the finish. Use a clean, dry cloth.
- Be sure to read the “Troubleshooting” section on common operating errors before concluding that your unit is faulty.
- Do not place another component on top of this unit, as damage or discoloration on the surface of the unit may result.
- To prevent damage by lightning, disconnect the power cord from the wall outlet during an electrical storm.
- When disconnecting the power cord from the wall outlet, grasp the plug; do not pull the cord.
- Do not plug the AC power plug to the wall outlet before you finish all connections.
- The voltage to be used must be the same as that specified on this unit. Using this unit with a higher voltage than that which is specified is dangerous and may result in a fire or other type of accident causing damage. YAMAHA will not be held responsible for any damage resulting from use of this unit with a voltage other than that which is specified.
- When listening to the receiver at a high volume level for a long time, the temperature inside the unit rises. To prevent overheating and possible damage to this unit, the internal fan starts running.
- Sudden temperature changes and storage or operation in an extremely humid environment may cause condensation inside the cabinet.

The unit is not disconnected from the AC power source as long as it is connected to the wall outlet, even if this unit itself is turned off. This state is called the standby mode. In this state, this unit is designed to consume a very small quantity of power.

CAUTION FOR CARRYING THE UNIT

Before carrying the unit, first remove all discs from the unit, press STANDBY/ON to turn the unit off, then disconnect the AC power plug from the wall outlet.

VOLTAGE SELECTOR (General model only)

The voltage selector (on the rear panel of this unit) must be correctly set to the voltage used locally before making any connection to the AC power supply.

FREQUENCY STEP switch <General model only>

Because the interstation frequency spacing differs in different areas, set the FREQUENCY STEP switch (located on the rear panel) according to the frequency spacing in your area. Before setting this switch, disconnect the AC power plug of this unit from the AC outlet.

CAUTION

Use of controls or adjustments or performance of procedures other than those specified herein may result in hazardous radiation exposure.

As the laser beam used in this compact disc player is harmful to the eyes, do not attempt to disassemble the cabinet. Refer servicing to qualified personnel only.

For Canadian Customers

To prevent electric shock, match wide blade of plug to wide slot and fully insert.

This Class B digital apparatus complies with CANADIAN ICES-003

The remote control

This remote control controls a whole system: not only RX-E100 but also CDX-E100. Moreover, a cassette deck (KX-E100) and MD recorder (MDX-E100) that level up your system can be operated by it. Operating buttons for each unit are explained on the pages below:

Receiver, RX-E100:	p.7
CD player, CDX-E100:	p.15
Cassette deck, KX-E100:	p.20
MD recorder, MDX-E100:	p.20

Loading the batteries for the remote control

- 1 Remove the battery compartment cover.

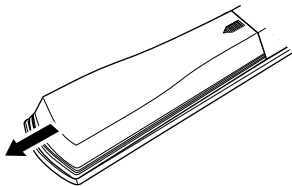

- 2 Insert 4 batteries into the battery compartment.

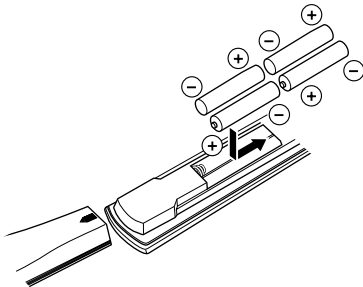

- 3 Replace the battery compartment cover.

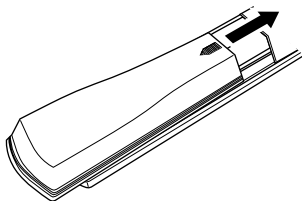

Battery replacement

If you find that the remote control must be used closer to the main unit than usual, the batteries are weak. Replace batteries with new ones.

Notes

- Use only AAA, UM-4, R03 batteries for replacement.
- Be sure the polarities are correct. (See the illustration inside the battery compartment.)
- Remove the batteries if the remote control will not be used for an extended period of time.
- If batteries leak, dispose of them immediately. Avoid touching the leaked material or letting it come in contact with clothing, etc. Clean the battery compartment thoroughly before installing new batteries.

Remote control operation range

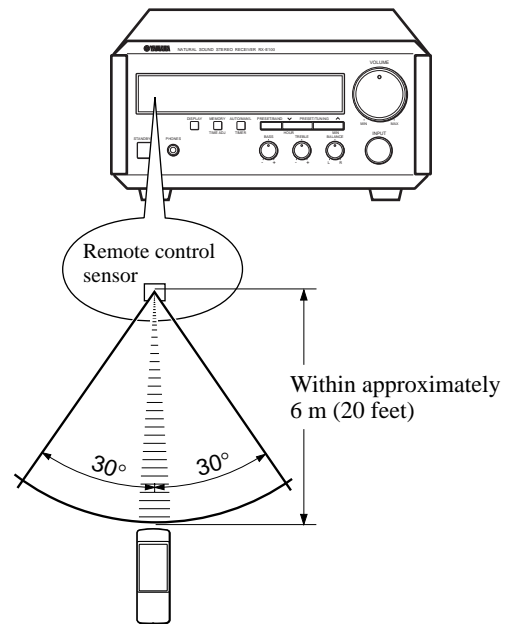

Notes

- There should be no large obstacles between the remote control and the main unit.
- If the remote control sensor is directly illuminated by strong lighting (especially an inverter type of fluorescent lamp, etc.), it might cause the remote control not to work correctly. In this case, reposition the main unit to avoid direct lighting.

Connecting the speakers

Never plug the AC power cord to the wall outlet until all connections are completed.

Follow the steps as shown below to connect the system using the supplied cords and accessories.

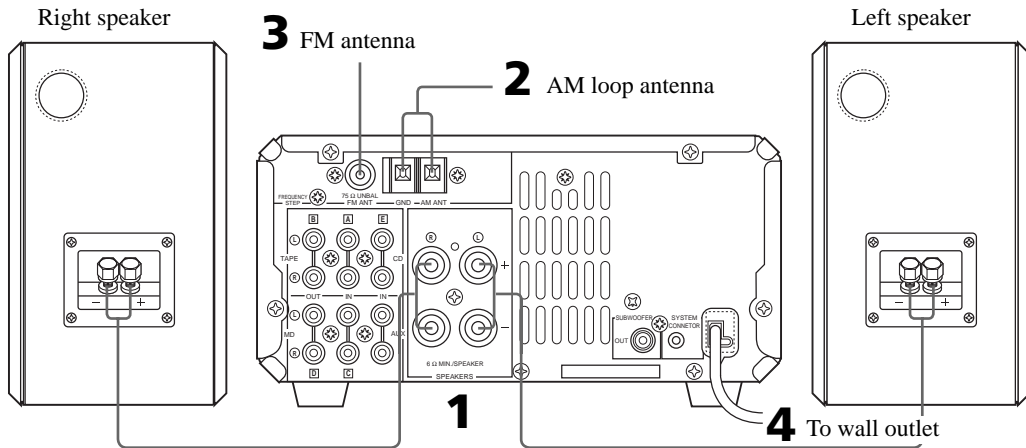

1 Connect the Speakers.

- ① Unscrew the knob.
- ② Remove approx. 5 mm (1/4") of insulation from each of the speaker wires and insert the bare wire into the terminal.
- ③ Tighten the knob to secure the wire.

Red: positive(+)
Black: negative(-)

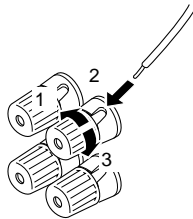

2 Connect the AM Antenna.

Set up the AM loop antenna, then connect it.

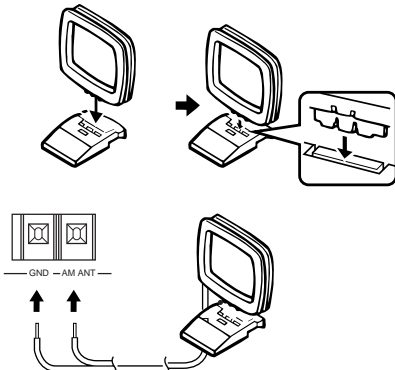

3 Connect the FM Antenna.

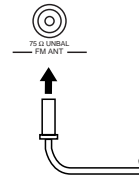

4 Connect the AC power cord to a wall outlet.

- Use external FM/AM antennas if you need better reception. Consult your dealer.
- The AM loop antenna should be placed apart from the main unit. The antenna may be hung on a wall.

To Connect the Subwoofer (optional)

You can reinforce the bass frequencies by adding a subwoofer (optional).

Connect the **SUBWOOFER OUT** terminal of the unit to the **INPUT** terminal of the subwoofer.

Connecting the system

Connecting RX-E100 and CDX-E100

- 1** Connect [E] to [E] using the RCA pin cable.
Insert the plugs into the jacks of the same colour.
- 2** Connect RX-E100 and CDX-E100 with the system control cable.
The other **SYSTEM CONNECTOR** of CDX-E100 is for connecting MDX-E100 or KX-E100.
- 3** Connect the AC power plug of CDX-E100 to **AC OUTLET** of RX-E100.

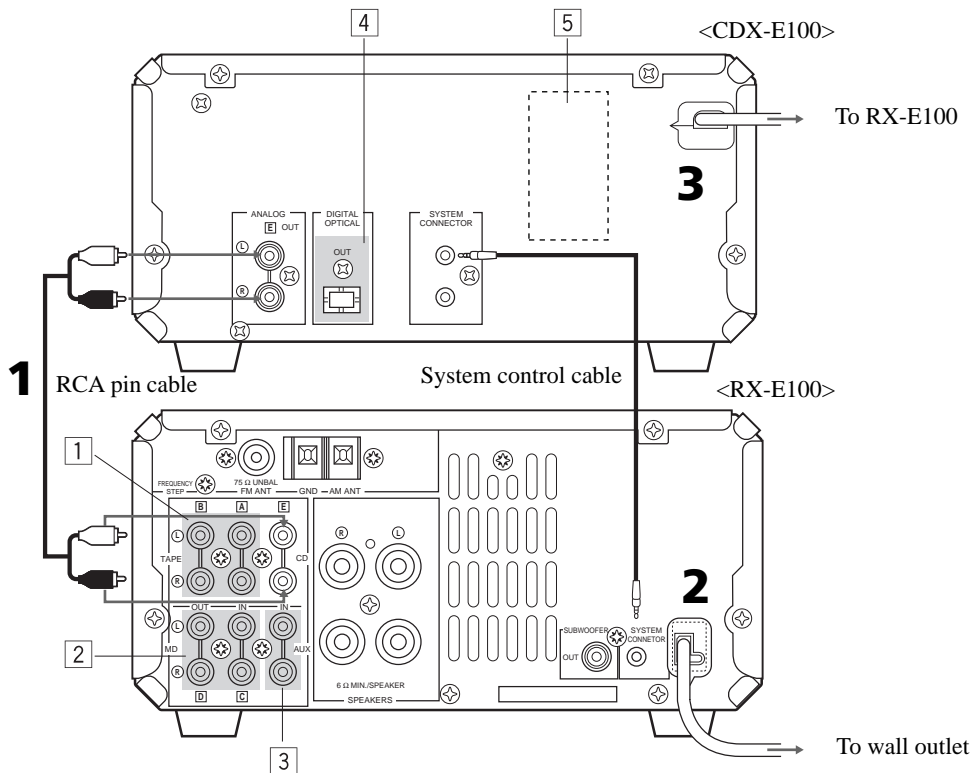

Adding KX-E100 and MDX-E100 to the above system (For details, refer to the owner's manual supplied with the respective component.)

- 1** Connect [A] and [B] of RX-E100 to [A] and [B] of KX-E100.
- 2** Connect [C] and [D] of RX-E100 to [C] and [D] of MDX-E100.
- 3** Connect an external component to the **AUX** terminal of RX-E100.
- 4** Connect **DIGITAL OPTICAL OUT** of CDX-E100 to **DIGITAL OPTICAL IN** of MDX-E100.

Take off the covers of the optical fiber cable plug, the **DIGITAL OPTICAL OUT** jack, and the **DIGITAL OPTICAL IN** jack before making digital connections. Be sure to replace the terminal's cover when the terminal on the rear panel is not being used, in order to protect from dust.

- 5** **AC OUTLET** (CDX-E100)
Connect the AC power plug of MDX-E100 or KX-E100 (Except for the UK model).

Front panel

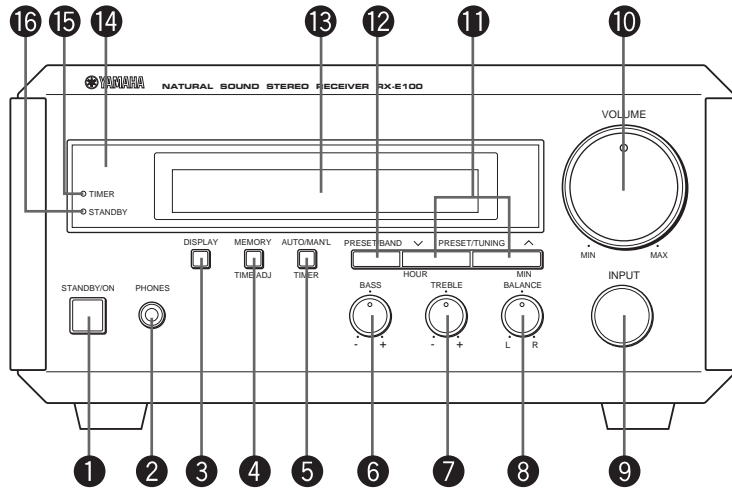

- ① **STANDBY/ON** (P.8)
- ② **PHONES** (P.8)
- ③ **DISPLAY** (P.11)
- ④ **MEMORY/TIME ADJ** (P.10/P.11)
- ⑤ **AUTO/MAN'L/TIMER** (P.9/P.12)
- ⑥ **BASS** (P.8)
- ⑦ **TREBLE** (P.8)
- ⑧ **BALANCE** (P.8)
- ⑨ **INPUT** (P.8)
- ⑩ **VOLUME** (P.8)
- ⑪ **PRESET/TUNING** \wedge/\vee (P.9)
- ⑫ **PRESET/BAND** (P.9)
- ⑬ **Display** (P.6)
- ⑭ **Remote Control Sensor** (P.3)
- ⑮ **TIMER** indicator (P.12)
- ⑯ **STANDBY** indicator (P.8)

Display

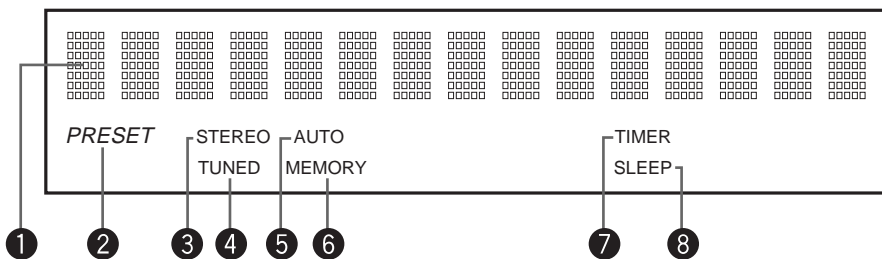

- ① **Multi-information display**
- ② **PRESET** indicator (P.10)
- ③ **STEREO** indicator (P.9)
- ④ **TUNED** indicator (P.9)
- ⑤ **AUTO** indicator (P.9)
- ⑥ **MEMORY** indicator (P.10)
- ⑦ **TIMER** indicator (P.12)
- ⑧ **SLEEP** indicator (P.13)

Remote control

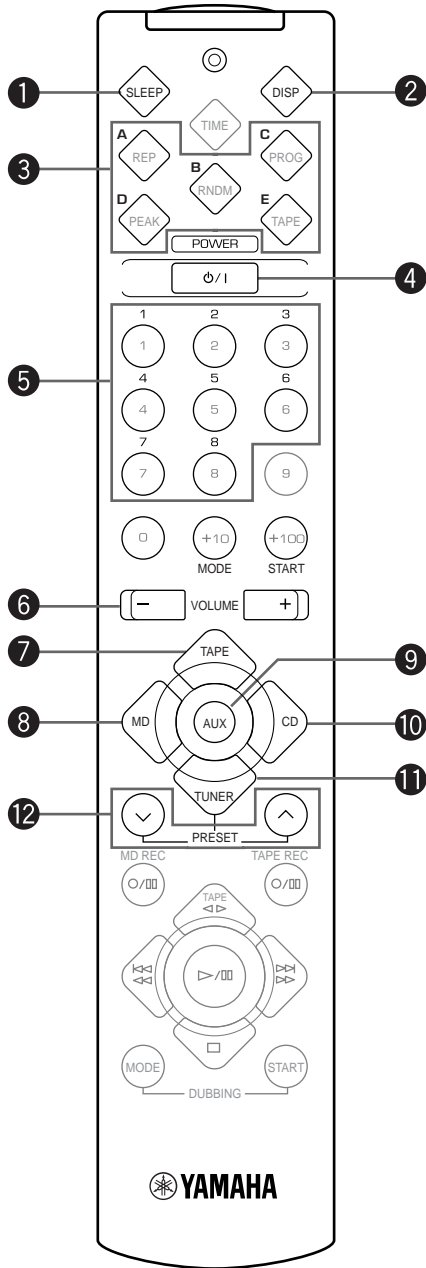

- ❶ SLEEP (P.13)
- ❷ DISP (Display) (P.11)
- ❸ A/B/C/D/E (P.10)
- ❹ POWER (P.8)
- ❺ Preset numbers (P.10)
- ❻ VOLUME + - (P.8)
- ❼ TAPE (KX-E100) (P.20)
- ❽ MD (MDX-E100) (P.20)
- ❾ AUX (The equipment connected to the AUX terminal) (P.5)
- ❿ CD (CDX-E100) (P.16)
- ⓫ TUNER (RX-E100) (P.10)
- ⓬ PRESET ^/∨ (P.10)

Note

- ❷-❿ are operation buttons and input selectors for each component.

Listening to a source

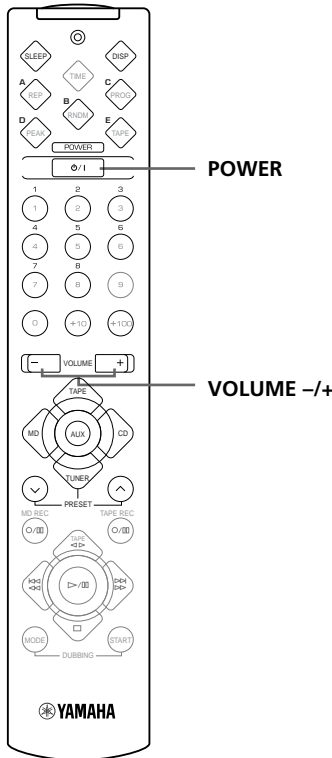
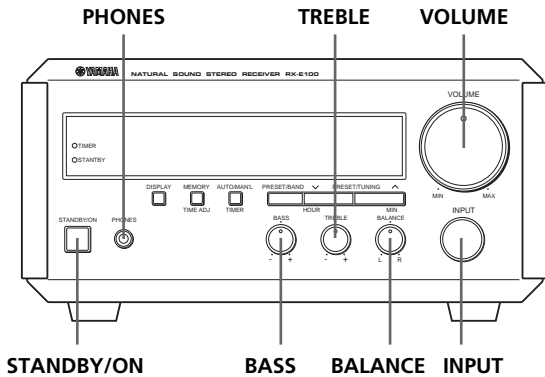

- 1 Set the volume to “MIN” by turning **VOLUME**.
- 2 Turn on the power by pressing **STANDBY/ON** on the front panel, or **POWER** on the remote control.
 - RX-E100 can be used to turn on or put in standby mode the system connected E100 series components depending on their prior standby/on status.
- 3 Select the desired input source by turning **INPUT** so that the source appears on the display.
 - When you operate the component connected to the **AUX** terminal, turn **INPUT** to select **AUX**.

- 4 Play the source. (Refer to the owner’s manual supplied with each selected component.)
- 5 Adjust the volume level by turning **VOLUME** on the front panel or pressing **VOLUME +** on the remote control.
- 6 If desired, adjust **BASS**, **TREBLE**, and **BALANCE**.

BASS: Turn this control clockwise to increase (or counterclockwise to decrease) the low frequency response.

TREBLE: Turn this control clockwise to increase (or counterclockwise to decrease) the high frequency response.

BALANCE: Adjust the balance of the output volume from the left and right speakers to compensate for sound imbalance caused by the speaker location or listening room conditions

- These controls are only effective for the sound from the main speakers.

When you use headphones

Connect the headphones to the **PHONES** jack. You can listen to the sound from the main speakers through the headphones.

When you have finished using this unit

Press **STANDBY/ON** on the front panel again or **POWER** on the remote control to set this unit to the standby mode.

- The **STANDBY** indicator lights up.

Auto power off function

RX-E100 will be put automatically into the standby mode under the following conditions:

- The component connected to RX-E100 is in stop mode and not operated for 30 minutes.
- **TUNER** or **AUX** is not selected as an input source.

Listening to the radio

You can find radio stations automatically and manually.

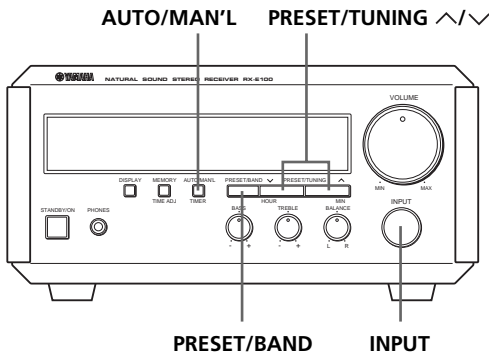

Manual tuning

- 1 Follow steps 1 and 2 described in “Automatic tuning.”
- 2 Press **AUTO/MAN'L** so that “AUTO” disappears from the display.
- 3 Press **TUNING** ^ (For a higher frequency) or ∨ (For a lower frequency) to select your desired station.
 - Each time you press **TUNING** ^ or ∨, the frequency changes step by step.

Automatic tuning

- 1 Select **TUNER** by turning **INPUT** so that the frequency of a radio station appears in the display.
- 2 Press **PRESET/BAND** to select the reception band. Do not select the preset tuning mode (in which “PRESET” appears on the display).
- 3 Press **AUTO/MAN'L** so that “AUTO” appears in the display.
- 4 Press **PRESET/ TUNING** ^ (For a higher frequency) or ∨ (For a lower frequency).
- 5 The unit starts searching for a station.

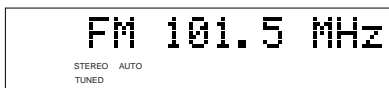

When the unit finds a station, the unit stops searching and “TUNED” appears on the display.

- 6 If the located station is not the one you want, repeat steps 4 and 5 until a station you want is tuned.

Notes

- If automatic tuning search does not find the desired station, try manual tuning as described next.
- When an FM stereo broadcast with sufficient signal strength is received, “STEREO” appears on the display and you can listen to stereo sound.

Setting the clock

You must set the clock before you use the timer functions. The clock is based on a 24-hour system for Australia and General models, and 12-hour system for US, Canada, and General models.

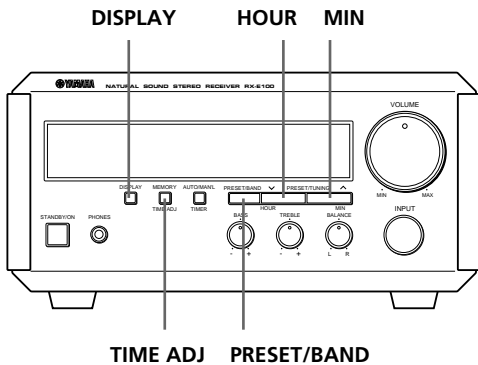

- 1 While the power is on, press **DISPLAY** to display the time.
- 2 While holding **TIME ADJ**, press **HOUR** to set the hour.
 - If you want to move the time in the reverse direction, press **HOUR** while holding **TIME ADJ** and **PRESET/BAND**.
- 3 While holding **TIME ADJ**, press **MIN** to set the minutes.
 - If you want to move the time in the reverse direction, press **MIN** while holding **TIME ADJ** and **PRESET/BAND**.

To display the clock

Press **DISPLAY**.

The current time appears for about 8 seconds, then the normal display returns.

Note

- In the event of a power failure or when the AC power cord is disconnected for more than five minutes, you must reset the clock.

Adjusting the brightness of the display

You can adjust the brightness of the display. If you have connected the CD player (CDX-E100), cassette deck (KX-E100), and/or MD recorder (MDX-E100) to this unit, the brightness of the displays is automatically adjusted to that of this unit.

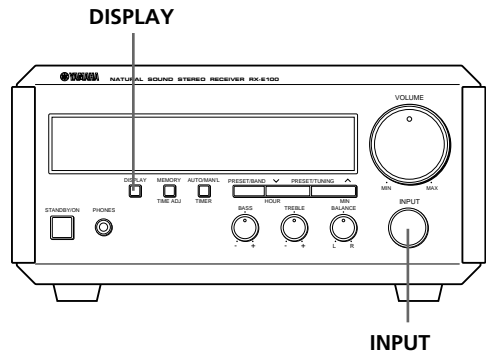

Press and hold **DISPLAY** for about two seconds so that "Dimmer ±0" appears on the display. While holding **DISPLAY**, turn **INPUT** clockwise to increase or counterclockwise to decrease brightness.

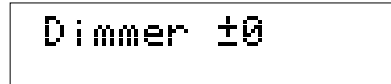

Control Range: ±0 to -6 (Preset value: ±0)

Before using the timer

If you want to use the cassette deck, KX-E100 or the MD Recorder, MDX-E100 for timer play or recording, you must first make the connections as shown in “Connecting the system” on page 5. For details, refer to the instructions supplied with the MDX-E100 or KX-E100.

Timer play and recording

By using the built-in timer, you can have the unit turn on at a specified time and begin playing or recording automatically. You can also specify the turn off time.

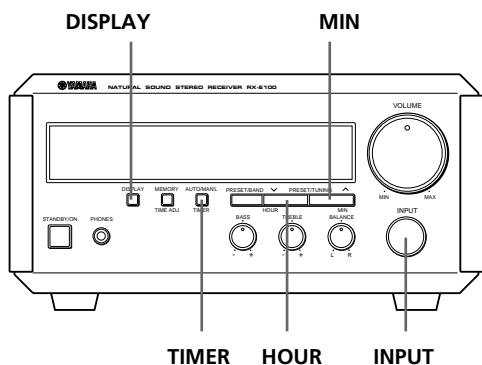

1 Press **DISPLAY**.
Whenever **DISPLAY** is pressed, the display mode changes as follows:

1. Clock Time (TIMER on/off mode)
If you have not set the clock yet “Set Clock” appears. You need to set the current time as described on page 11.



2. Timer Input
Select the source to be played by turning **INPUT**.
 - Timer recording is possible only when you select TUNER or AUX.



3. Timer REC
Select the recording component by turning **INPUT**.
If you like to enjoy timer play with TUNER or AUX, select “REC Mode OFF”.

(Example)

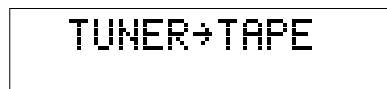

4. ON Time
“ON Time” appears on the display for a second, and changed to the time setting mode.
Press **HOUR** to set the hour.
Press **MIN** to set the minute.



5. OFF Time
Set the time the same way as above.
If you set the ON time but not OFF time, the timer play or recording will finish automatically after an hour.

Notes

- The display mode will change in about 8 seconds. If the mode is changed before the setting is completed, call the mode again by pressing **DISPLAY** once or more.
- If you select the input other than TUNER and AUX on “2. Timer Input”, “3. Timer REC” is skipped.

- 2** Press **TIMER** to complete the timer setting.
The system is put in the standby mode.
 - The **STANDBY** and **TIMER** indicators light up.

If you continue using the system, press **STANDBY/ON** to turn on this unit.

To cancel the timer play setting

Press **DISPLAY** to show the current time, then press **TIMER** so that “TIMER” goes off from the display. You can also cancel by pressing **TIMER** in standby mode.

Note

- In the event of a power failure or when the AC power cord is disconnected for more than five minutes, you must reset the clock.

Sleep timer

The unit can be turned off automatically at a selected SLEEP time.

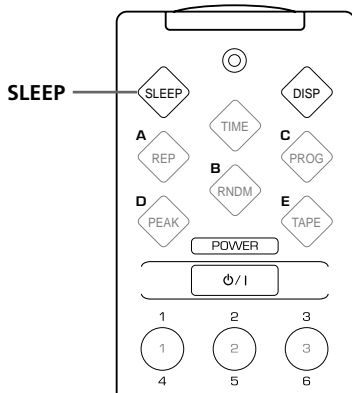

- 3 The unit will turn off automatically when the selected sleep time is reached.

- 1 Play the desired sound source.
- 2 Press **SLEEP** repeatedly until the desired sleep time appears in the display.
Each time you press **SLEEP**, the sleep time changes as follows:

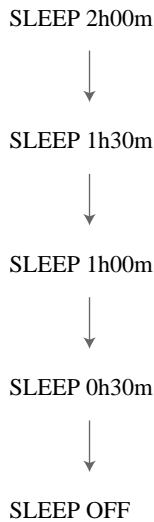

About 4 seconds after setting, the normal display will resume.

- “SLEEP” will appear in the display.

Front panel

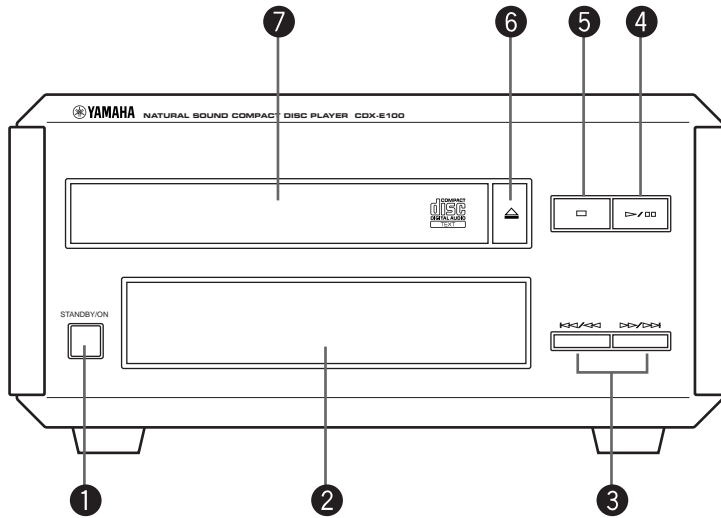

- ① **STANDBY/ON** (P.16)
- ② Display (this page)
- ③ \lll/\lll (Skip/Search Backward)
- ④ \triangleright/\lll (Play/Pause) (P.16)
- ⑤ \square (Stop) (P.16)
- ⑥ \triangle (Open/Close) (P.16)
- ⑦ Disc Tray (P.16)
- $\triangleright\triangleright/\triangleright\triangleright$ (Skip/Search Forward) (P.16)

Display

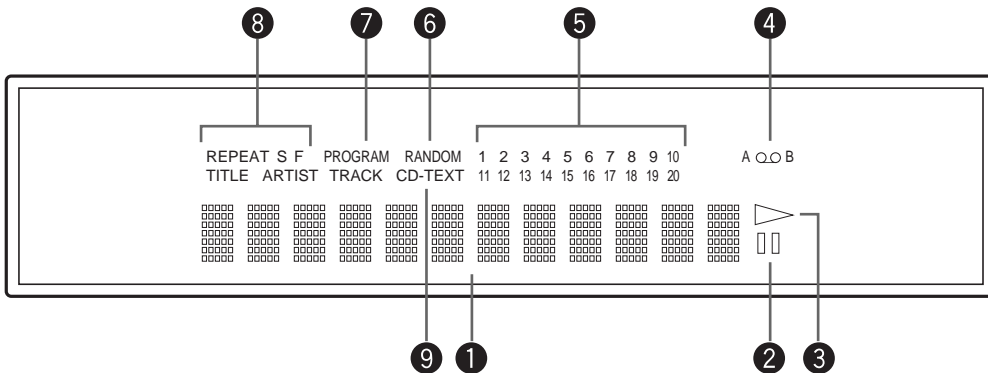

- ① Multi-information Display
- ② \lll Pause indicator
- ③ \triangleright Play indicator
- ④ A Q O B Tape side indicator (P.22)
- ⑤ Music calendar
- ⑥ **RANDOM** indicator (P.17)
- ⑦ **PROGRAM** indicator (P.18)
- ⑧ **REPEAT S/F** (Single or Full) indicator (P.18)
- ⑨ **CD-TEXT** indicator (P.17)

Remote control

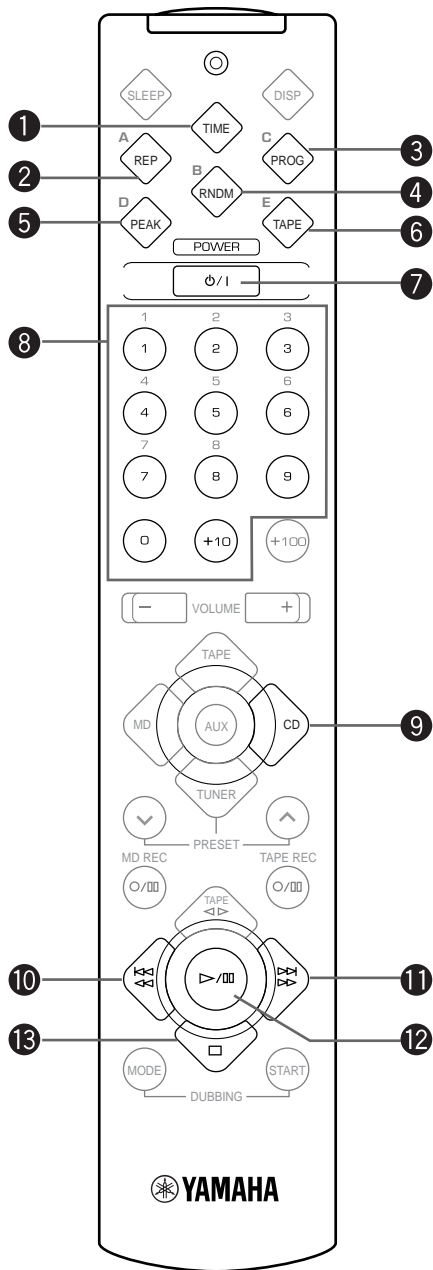

- ❶ TIME (P.17)
- ❷ REP (Repeat) (P.18)
- ❸ PROG (Program) (P.18)
- ❹ RNDM (Random) (P.17)
- ❺ PEAK (Peak Search) (P.19)
- ❻ TAPE (P.22)
- ❼ POWER (P.16)
- ❽ Numeric buttons (P.16)
- ❾ CD input (P.16)
- ❿ \lll/\lll (Skip/Seach Backward) (P.16)
- ⓫ \ggg/\ggg (Skip/Seach Forward) (P.16)
- ⓬ \triangleright/\parallel (Play/Pause) (P.16)
- ⓭ \square (Stop) (P.16)

CD playback

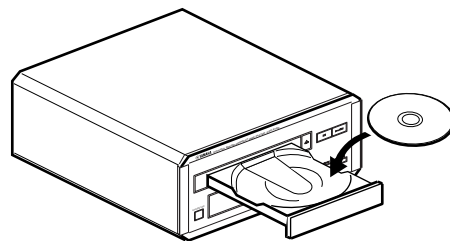
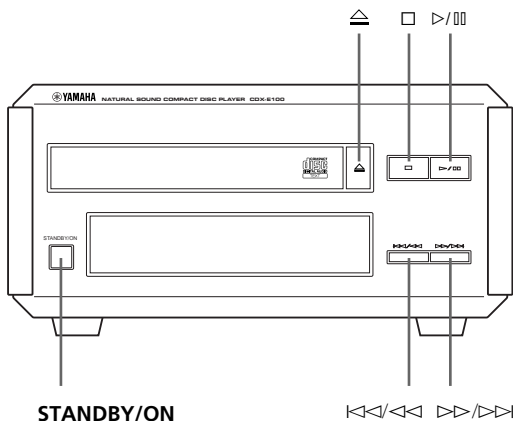

- Press to open the disc tray, and place a CD on the tray.

- Press to start playback.
The unit starts playback of the CD.

To pause playback

Press .
To resume play, press again.

To stop playback

Press .

To eject the CD

Press to open the disc tray, and remove the CD from the tray.

To play a specific track on the disc (Skip)

Direct play

Select a desired track using the numeric button.
(Example: To select 35, press +10 three times so that "3 -" appears in the display, then press 5.)

Skip play

Press to skip forward or to skip backward. Press once for each track to be skipped.

Notes

- You cannot enter a number that is higher than the last track number on the disc.
- These operations can also be performed when the unit is in the pause or stop mode.
- During stop mode, if or is pressed, the track number successively changes to higher numbers (or lower numbers).

To advance or reverse playback rapidly (Search)

Press and hold to advance playback rapidly, and to reverse playback rapidly.

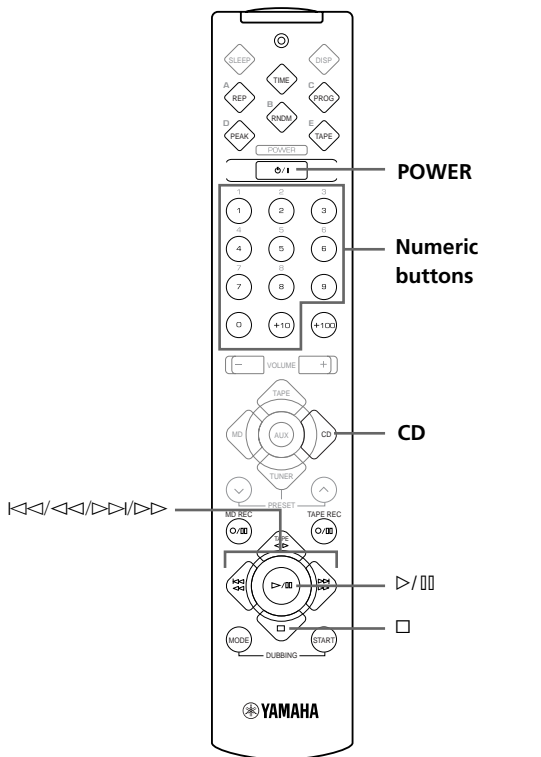

To play CDs

- Press **STANDBY/ON** to turn on this unit and also RX-E100.
- Press **CD** on the remote control in order to operate the CD player by the remote control.

Selecting the time display and CD TEXT

You can select any of four time displays by pressing **TIME**. When you play a CD with CD TEXT, the disc title, artist name, and track name are also displayed.

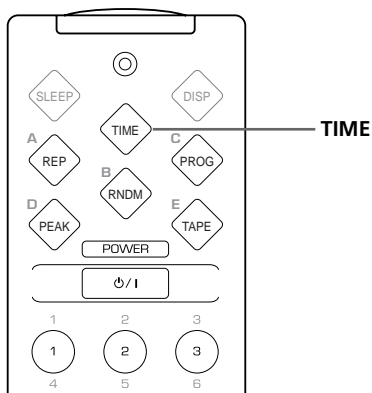

Each time you press **TIME**, the display changes as follows:

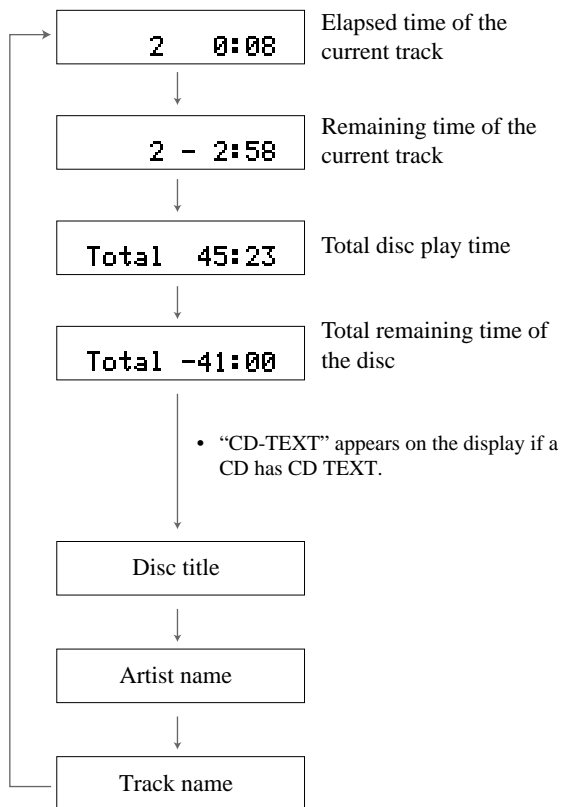

Note

- The disc title, artist names, or track names may not be displayed with some CD TEXT discs. In this case, "(NO ENTRY)" appears on the display.

Random-sequence play

The unit can play all the tracks in a random sequence.

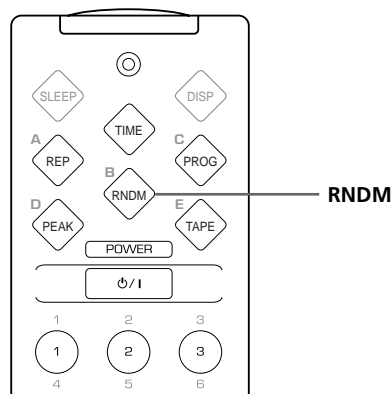

Press **RNDM**.

- "RANDOM" appears on the display.
- The unit starts random sequence play.

To cancel random-sequence play mode

Press **□** or **RNDM**.

- "RANDOM" disappears from the display.

Notes

- This feature will not function during programming, or during programmed play.
- If >>> is pressed during random-sequence play, the next randomly programmed track will be played. If <<< is pressed, play will return to the beginning of the current track.
- Total remaining time on the disc will not be displayed during random-sequence play.

Repeat play

You can play any desired track or disc repeatedly. Press **REP** to select the repeat mode.

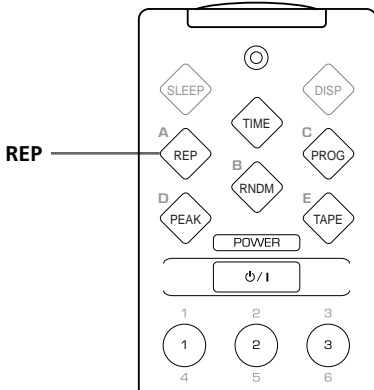

SINGLE REPEAT

The current track is played repeatedly.



FULL REPEAT

The current disc is played repeatedly.

- In random-sequence play mode, all randomly sequenced tracks are played repeatedly in the same order.





To cancel repeat play mode

Press **REP** successively until "REPEAT F" disappears from the display.

Program play

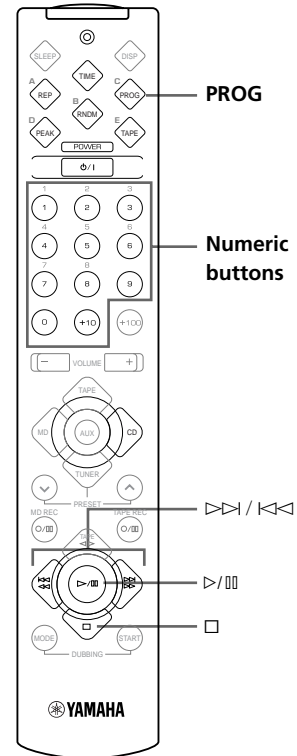
By creating a program, you can enjoy listening to your favourite tracks in any desired order. As many as 30 tracks can be programmed in sequence.



- 1 Press  to stop the unit.
- 2 Press **PROG**.
 - "PROGRAM" appears in the display.



- 3 Use the numeric buttons to select a track number until the desired track number appears on the display.

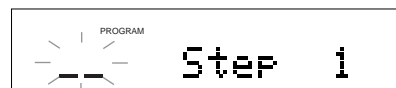

- 4 Repeat step 3 to program more tracks. You can select the same track again.
- 5 Press  to start program play.

To stop program play mode

Press □.

Note

- ▷▷| or |◀◀ can be used during program play to skip to tracks within the program.

To check program data

1. Press □ to stop program play.
2. Press **PROG**. Then each time you press ▷▷| / |◀◀, the track number and the program number are displayed in the order of the program.

To change program data

1. Follow the preceding procedure described in “To check program data.”
2. Display the track number to be changed by pressing ▷▷| / |◀◀.
3. Press the numeric button of the desired track. The previously programmed track will be cleared from memory and the new one will be programmed.

To delete all program data

When program play is stopped, press □.

Peak level search

This unit can find the peak sound level on the CD for optimum adjustment of the recording volume level.

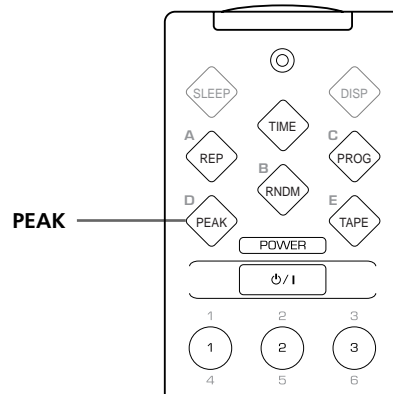

Press **PEAK** while the player is stopped or the tray is opened.

- It takes a few minutes to search for the peak level. When found, the unit plays the peak level for 4 seconds repeatedly.

To cancel searching

Press □.

Operating the cassette deck, KX-E100 and MD recorder, MDX-E100 with the remote control

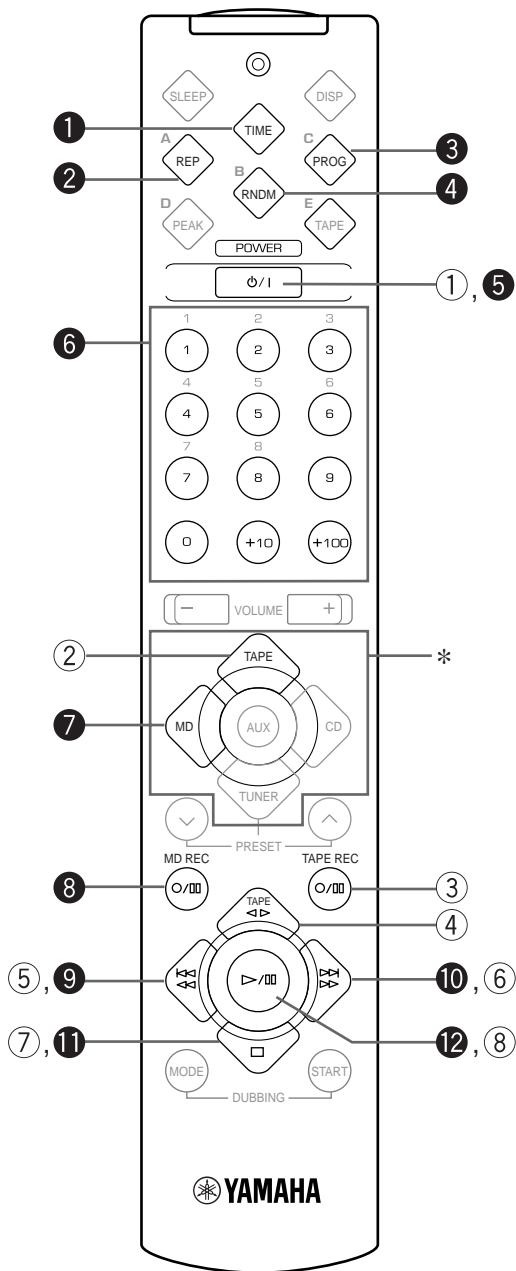

MDX-E100

- ① **TIME** (Same function as **DISPLAY** on MDX-E100 remote control)
- ② **REP** (Repeat)
- ③ **PROG** (Program)
- ④ **RNDM** (Random)
- ⑤ **POWER**
- ⑥ Numeric buttons
- ⑦ **MD** input
- ⑧ **MD REC/PAUSE**
- ⑨ ◀◀/◀◀ (Skip/Search Backward)
- ⑩ ▶▶/▶▶ (Skip/Search Forward)
- ⑪ ◻ (Stop)
- ⑫ ▷/⏸ (Play/Pause)

KX-E100

- ① **POWER**
- ② **TAPES** input
- ③ **TAPES REC/PAUSE**
- ④ ◀▶ (Tape Direction)
- ⑤ ◀◀/◀◀ (Rewind/Music Search Backward)
- ⑥ ▶▶/▶▶ (Fast Forward/Music Search Fast Forward)
- ⑦ ◻ (Stop)
- ⑧ ▷/⏸ (Play)**

* Input selectors when recording.

** There is no pause function on KX-E100.

Before recording

When you record by using MDX-E100 or KX-E100, you must first make the connections as shown in “Connecting the system” on page 5. For details, refer to the instructions supplied with the MDX-E100 or KX-E100. A source from the component which is connected to the **AUX** terminal component can be recorded on a tape or MD.

Dubbing setting

There are six different combinations of components. Once you choose a certain mode, recording starts and ends automatically in a certain way for each mode.

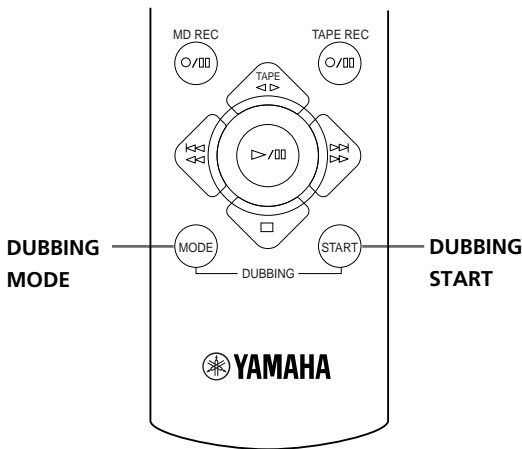

1 Decide the combination of the components. Each time you press **DUBBING MODE**, the mode will change in the below order.

① DUB CD→TAPE

- Recording automatically starts from the beginning of the tape. (By pressing **DUBBING START**, the tape automatically rewinds to the beginning if it is in the middle.)
- When the recording on side A finishes while a track is being played back, the recording on side B starts from the beginning of the same track.
- The sound is automatically faded out when it gets close to the end of side B.



② DUB CD/Tr1→TAPE

- Only the first track is recorded. After recording the CD tray opens automatically.



③ DUB CD→MD



④ DUB CD/Tr1→MD

- Same as CD (Tr1) → TAPE



⑤

Play unit	Record unit
DUB MD→TAPE	

- Same as CD → TAPE



⑥

Play unit	Record unit
DUB TAPE→MD	

- Recording automatically starts at the beginning of the tape. (By pressing **DUBBING START**, the tape automatically rewinds to the beginning if it is in the middle.)

2 Press **DUBBING START** to start recording.

Note

- The displays ①~⑥ which include the component you have not connected to your receiver (RX-E100) will be skipped.

TAPE Programming

By specifying the length of the tape, the CD player, CDX-E100 programs tracks or helps you to program tracks so they will fit onto the tape with the least amount of unrecorded space remaining at each end of the tape. There are three ways of programming.

1 Manual TAPE programming

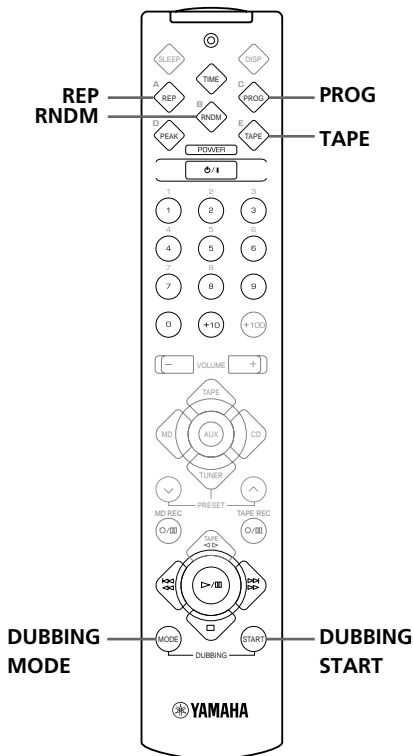

- 1 Insert the desired disc into the CD player, and load a blank tape into the KX-E100.
- 2 Press **TAPE** repeatedly to select the length of tape to be used. Each time you press **TAPE**, the length of the tape changes as follows:

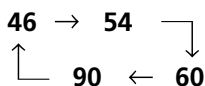

- You can use numeric buttons to input the length of the tape.

- 3 Press **PROG** to start programming.
 - “A Q O B” appears in the display to indicate the direction of the tape.
- 4 Select the desired track number using numeric buttons.
 - Repeat step 4 to continue programming tracks.
 - The remaining time is shown on the display. If the track is longer than the remaining time, “Error” appears on the display.
- 5 Press **TAPE** to continue programming tracks on side B.
 - Repeat step 4.
- 6 Press **PROG** to confirm the program.
- 7 Choose CD → TAPE by pressing **DUBBING MODE**, and press **DUBBING START** to start recording.



2 Automatic TAPE programming

- 1 Repeat steps 1 and 2 of “Manual TAPE programming”.
- 2 Press **REP** to start programming.
 - Programming is done in the order on the CD from side A to side B. When complete, the programmed track number and total time are indicated in the display for 3 seconds.
- 3 Press **PROG** to confirm the program.
- 4 Choose CD → TAPE by pressing **DUBBING MODE**, and press **DUBBING START** to start recording.

3 Random TAPE programming

- 1 Repeat steps 1 and 2 of “Manual TAPE programming”.
- 2 Press **RNDM** to start programming.
 - Programming of CD tracks is done randomly from side A to side B. When complete, the programmed track number and total time are indicated in the display for 3 seconds.
- 3 Press **PROG** to confirm the program.
- 4 Choose CD → TAPE by pressing **DUBBING MODE**, and press **DUBBING START** to start recording.

CD preventive care

- This compact disc player is designed for playing compact discs bearing the  or  mark only. Never attempt to load any other type of disc into the unit. The unit will also play 8-cm (3-inch) compact discs.
- Compact discs are not subjected to wear during play, but damage to the disc surface when the disc is being handled can adversely affect the disc's play.
- Do not use cleaning discs or warped discs. All of these could damage the unit.

- Compact discs are not affected by small particles of dust or fingerprints on their playing surface, but even so they should be kept clean. Wipe by using a clean, dry cloth. Do not wipe with a circular motion; wipe straight outward from the center.

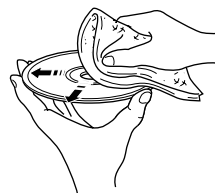

To prevent a malfunction of this unit

- Do not use any non standard shaped CD (heart, etc.) available on the market, because it may damage the unit.



- Do not try to clean the disc's surface by using any type of disc cleaner, record spray, antistatic spray or liquid, or any other chemical-based liquid, because such substances might irreparably damage the disc's surface.
- Do not expose discs to direct sunlight, high temperature or high humidity for a long period of time, because these might warp or otherwise damage the disc.

- Do not use a CD with tape, seals, or paste on it, because damage to the unit may result.



Troubleshooting

If the unit fails to operate normally, check the following points to determine whether the fault can be corrected by the simple measures suggested. If it cannot be corrected, or if the fault is not listed in the SYMPTOM column, disconnect the power cord and contact your authorized YAMAHA dealer or service center for help. When taking the service, the MDX-E100 or KX-E100 may be needed. For details, contact your authorized YAMAHA dealer or service center.

	SYMPTOM	CAUSE	REMEDY
RX-E100 RECEIVER	The unit does not switch ON when the STANDBY/ON switch is pressed.	The AC power cord is not connected or not completely connected.	Securely connect the power cord.
	No sound from one speaker.	Loose speaker connections.	Connect properly.
	No sound from speakers.	Internal protection circuit is functioning.	Unplug the AC power cord from the wall outlet, and then plug in again.
	No sound from an external unit connected with this unit or play does not begin.	Incorrect cord connections.	Connect the cords properly. If the problem persists, the cords may be defective.
Input source selection is not proper.		Make a proper input source selection.	

ADDITIONAL INFORMATION

	SYMPTOM	CAUSE	REMEDY
RX-E100 RECEIVER	Excessive static in FM broadcasts.	Interference from starting motor of a nearby car.	Position the FM antenna as high and as far away from nearby roads as possible. Connect using a coaxial cable.
		Interference from the thermostat of a nearby electrical appliance.	
	Noise increases during stereo broadcasts.	Antenna input is too weak due to obstructions or excessive distance from the broadcasting station.	Check the antenna connection. Install a multi-element type FM antenna if possible.
	Stereo broadcasts are noisy and STEREO indicator blinks on and off.	Insufficient antenna input.	Install an antenna appropriate for the electric field strength of your area.
	Cannot select preset stations.	Preset memory has been erased.	Reprogram memory presets.
	Buzzing or static during AM broadcasts.	Interference from sources such as lightning, fluorescent lights, electric motors or thermostat of nearby electrical appliance.	The problem is difficult to eliminate, but can be lessened by grounding AM loop antenna.
		TV or microprocessor is being used nearby.	Move away from TV or microprocessor.
	AM broadcast sensitivity is poor.	Radio signal is weak or the antenna is not properly connected.	Properly connect the AM loop antenna.
Change orientation of the AM loop antenna.			
Install an external AM loop antenna.			
Cannot set timer.	Current time is not set.	Set current time.	
The unit does not work normally.	The internal microcomputer has been frozen by an external electric shock (lightning, excessive static electricity, etc.) or the power supply with low voltage.	Unplug the AC power cord from the wall outlet, and then plug in again after about one minute.	
CDX-E100 CD PLAYER	Play does not begin.	The disc is damaged.	Check the disc carefully; replace it if necessary.
		There is moisture on the laser pick-up.	Wait 20 to 30 minutes after switching the unit ON before trying to play a disc.
		The disc has been loaded upside down.	Reload the disc with the label side facing up.
		The disc is dirty.	Clean the disc.
	Play is delayed, or begins at the wrong place.	The disc may be scratched or damaged.	Check the disc carefully; replace it if necessary.
	CD synchronized recording or Automatic recording function does not work.	The system cable is not connected securely.	Connect the system cable properly.
	Sound "skips."	The unit is being subjected to vibrations or impacts.	Relocate the unit.
		The disc is dirty.	Clean the disc.
Sound "hums."	Improper cable connections.	Securely connect the audio cables. If the problem persists, the cables may be defective.	
Noise from inside of the unit.	The disc may be warped.	Replace the disc.	
REMOTE CONTROL	The remote control does not work.	The batteries of the remote control are too weak.	Replace the batteries with new ones.
		Remote control is too far away or is being used at an incorrect angle.	Use within 6 meters and 60 degree radius.
		Direct sunlight or lighting (of an inverter type of fluorescent lamp, etc.) is striking the remote control sensor of the unit.	Change the position of the unit.
	TV functions strangely when the remote control is being used.	Remote control is being used near TV set with a remote control sensor.	Relocate this unit away from the TV or cover the TV's remote control sensor.

Specifications

<RX-E100>

Amplifier section

Minimum RMS output power per channel	50 W + 50 W (6Ω 1kHz 0.07% THD)
	40 W + 40 W (6Ω 20 - 20,000Hz 0.1% THD)
DIN Standard output power per channel (Europe model)	60 W + 60 W (4Ω 1kHz 0.7% THD)
Input sensitivity/Impedance	
CD/TAPE/MD/AUX	150 mV/47 k-ohms

Tuner section

Tuning range	
FM	
[U.S.A. and Canada models]	87.5 – 107.9 MHz
[U.K., Europe, Australia, and General models]	87.50 – 108.00 MHz
AM	
[U.S.A. and Canada models]	530 – 1710 kHz
[U.K., Europe, and Australia models]	531 – 1611 kHz
[General model]	530/531 – 1710/1611 kHz
Sensitivity	
FM (S/N 30dB)	1.5 μV
FM (S/N 26dB) (DIN)	1.8 μV
AM	300 μV/m

General

Power supply	
[U.S.A. and Canada models]	AC 120 V, 60 Hz
[Australia model]	AC 240 V, 50 Hz
[U.K. and Europe models]	AC 230 V, 50 Hz
[General model]	AC 110/120/220/240 V, 50/60 Hz
Power consumption	
[U.S.A. and Canada models]	110 W
[U.K., Europe, Australia, and General models]	100 W
Dimensions (W x H x D)	217 x 108 x 312 mm
Weight	4.5 kg
Accessories	Remote control
	Batteries
	Indoor FM antenna
	AM loop antenna

<CDX-E100>

CD player section

D/A converter	S-bit DAC
Frequency response (2 – 20,000 Hz)	±0.5 dB
S/N ratio	102 dB

Laser Diode Properties

- Material: GaAlAs
- Wavelength: 780 nm
- Emission duration: continuous
- Laser output: max. 44.6 μW*

* This output is the value measured at a distance of about 200 mm from the objective lens surface on the Optical Pick-up Block.

General

Power supply	
[U.S.A. and Canada models]	AC 120 V, 60 Hz
[Australia model]	AC 240 V, 50 Hz
[U.K. and Europe models]	AC 230 V, 50 Hz
[General model]	AC 110/120/220/240 V, 50/60 Hz
Power consumption	13 W
Dimensions (W x H x D)	217 x 108 x 290 mm
Weight	3.0 kg
Accessories	RCA pin cable
	System control cable

Specifications are subject to change without notice.



YAMAHA ELECTRONICS CORPORATION, USA 6660 ORANGETHORPE AVE., BUENA PARK, CALIF. 90620, U.S.A.
YAMAHA CANADA MUSIC LTD. 135 MILNER AVE., SCARBOROUGH, ONTARIO M1S 3R1, CANADA
YAMAHA ELECTRONIK EUROPA G.m.b.H. SIEMENSSTR. 22-34, 25462 RELINGEN BEI HAMBURG, F.R. OF GERMANY
YAMAHA ELECTRONIQUE FRANCE S.A. RUE AMBROISE CROIZAT BP70 CROISSY-BEAUBOURG 77312 MARNE-LA-VALLÉE CEDEX02, FRANCE
YAMAHA ELECTRONICS (UK) LTD. YAMAHA HOUSE, 200 RICKMANSWORTH ROAD WATFORD, HERTS WD1 7JS, ENGLAND
YAMAHA SCANDINAVIA A.B. J A WETTERGRENS GATA 1, BOX 30053, 400 43 VÄSTRA FRÖLUNDA, SWEDEN
YAMAHA MUSIC AUSTRALIA PTY, LTD. 17-33 MARKET ST., SOUTH MELBOURNE, 3205 VIC., AUSTRALIA

YAMAHA CORPORATION

Printed in Malaysia



V423460