



AB



DESKTOP AUDIO SYSTEM

TSX-120

OWNER'S MANUAL

■ For U.K. customers

If the socket outlets in the home are not suitable for the plug supplied with this appliance, it should be cut off and an appropriate 3 pin plug fitted. For details, refer to the instructions described below.

Note

The plug severed from the mains lead must be destroyed, as a plug with bared flexible cord is hazardous if engaged in a live socket outlet.

■ Special Instructions for U.K. Model

IMPORTANT

THE WIRES IN MAINS LEAD ARE COLOURED IN ACCORDANCE WITH THE FOLLOWING CODE:

Blue: NEUTRAL

Brown: LIVE

As the colours of the wires in the mains lead of this apparatus may not correspond with the coloured markings identifying the terminals in your plug, proceed as follows:

The wire which is coloured BLUE must be connected to the terminal which is marked with the letter N or coloured BLACK. The wire which is coloured BROWN must be connected to the terminal which is marked with the letter L or coloured RED.

Make sure that neither core is connected to the earth terminal of the three pin plug.

● The name plate is located on the bottom of the unit.

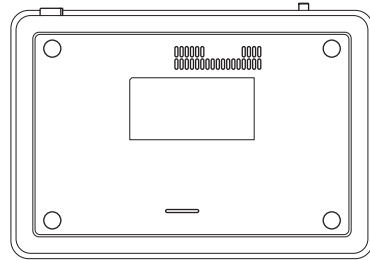

Caution: Read this before operating your unit.

- 1 To assure the finest performance, please read this manual carefully. Keep it in a safe place for future reference.
- 2 Install this unit in a well ventilated, cool, dry, clean place with at least 15 cm on the top, 10 cm on the left and right, and 10 cm at the back of this unit — away from direct sunlight, heat sources, vibration, dust, moisture, and/or cold.
- 3 Locate this unit away from other electrical appliances, motors, or transformers to avoid humming sounds.
- 4 Do not expose this unit to sudden temperature changes from cold to hot (or vice versa), and do not locate this unit in an environment with high humidity (i.e., a room with a humidifier) to prevent condensation inside this unit, which may cause an electrical shock, fire, damage to this unit, and/or personal injury.
- 5 Avoid installing this unit where foreign object may fall onto this unit and/or this unit may be exposed to liquid dripping or splashing. On the top of this unit, do not place:
 - Other components, as they may cause damage and/or discoloration on the surface of this unit.
 - Burning objects (i.e., candles), as they may cause fire, damage to this unit, and/or personal injury.
 - Containers with liquid in them, as they may fall and liquid may cause electrical shock to the user and/or damage to this unit.
- 6 Do not cover this unit with a newspaper, tablecloth, curtain, etc. in order not to obstruct heat radiation. If the temperature inside this unit rises, it may cause fire, damage to this unit, and/or personal injury.
- 7 Do not plug in this unit to a wall outlet until all connections are complete.
- 8 Do not operate this unit upside-down. It may overheat, possibly causing damage.
- 9 Do not use force on switches, knobs and/or cords.
- 10 When disconnecting the power cable from the wall outlet, grasp the plug; do not pull the cable.
- 11 Do not clean this unit with chemical solvents; this might damage the finish.
- 12 Only voltage specified on this unit must be used. Using this unit with a higher voltage than specified is dangerous and may cause fire, damage to this unit, and/or personal injury. Yamaha will not be held responsible for any damage resulting from use of this unit with a voltage other than specified.
- 13 To prevent damage by lightning, keep the power cable disconnected from a wall outlet or this unit during a lightning storm.
- 14 Do not attempt to modify or fix this unit. Contact qualified Yamaha service personnel when any service is needed. The cabinet should never be opened for any reasons.
- 15 When not planning to use this unit for long periods of time (i.e., vacation), disconnect the AC power plug from the wall outlet.
- 16 Be sure to read the “TROUBLESHOOTING” section on common operating errors before concluding that this unit is faulty.
- 17 Before moving this unit, press **ON/OFF** to set the system to off, and disconnect the AC power plug from the wall outlet.
- 18 Condensation will form when the surrounding temperature changes suddenly. Disconnect the power cable from the outlet, then leave this unit alone.
- 19 When using this unit for a long time, this unit may become warm. Turn the system off, then leave this unit alone for cooling.
- 20 Install this unit near the wall outlet and where the AC power plug can be reached easily.
- 21 The batteries shall not be exposed to excessive heat such as sunshine, fire or the like.

This unit is not disconnected from the AC power source as long as it is connected to the wall outlet, even if this unit itself is turned off by **ON/OFF**. In this state, this unit is designed to consume a very small quantity of power.

WARNING

TO REDUCE THE RISK OF FIRE OR ELECTRIC SHOCK, DO NOT EXPOSE THIS UNIT TO RAIN OR MOISTURE.

CAUTION

Use of controls or adjustments or performance of procedures other than those specified herein may result in hazardous radiation exposure.

CAUTION

Danger of explosion if battery is incorrectly replaced. Replace only with the same or equivalent type.

Taking care of the unit

When you wipe this unit, use a clean dry cloth.

CONTENTS

PREPARATION

PREPARATIONS BEFORE USING THIS UNIT	2
Turning on/off the system.....	4
Adjusting the clock	4



OPERATION

USING USEFUL FUNCTIONS	5
Using the alarm functions.....	5
Setting sleeping mode.....	8
Setting Dimmer mode.....	8
Switching DSP mode.....	8
BASIC OPERATION	9
LISTENING TO iPod™ AND EXTERNAL SOURCES	10
Listening to your iPod™	10
Playing back external sources.....	12
LISTENING TO DAB STATIONS	13
Setting the antenna.....	13
Preparing for DAB reception.....	14
Tuning DAB stations	14
DAB station information	15
Presetting DAB stations.....	16
Selecting preset DAB stations (Preset tuning)	16
Using DAB FUNCTION	17
DAB frequency information	18
LISTENING TO FM RADIO STATIONS	19
Tuning radio stations	19
Presetting radio stations.....	19
Selecting preset radio stations (Preset tuning).....	20
Receiving Radio Data System stations (U.K. model only)	20

ADDITIONAL INFORMATION

TROUBLESHOOTING	21
General.....	21
iPod™	21
DAB reception	22
Radio reception.....	23
Remote control	23
SPECIFICATIONS	24

■ About this manual

- This unit is iPod and also iPhone-compatible. “iPod” described in this manual may also refer to “iPhone”.
- In this manual, operations that can be performed with either this unit or its remote control are explained using the unit.
- The symbol “” with page number(s) indicates the corresponding reference page(s).
- Notes contain important information about safety and operating instructions.  indicates a tip for your operation.
- This manual is printed prior to production. Design and specifications are subject to change in part as a result of improvements, etc. In case of differences between the manual and the product, the product has priority.

■ Supplied accessories

This product includes the following accessories. Make sure you have all of the following parts.

Remote control

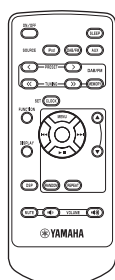

Owner's manual



PREPARATIONS BEFORE USING THIS UNIT

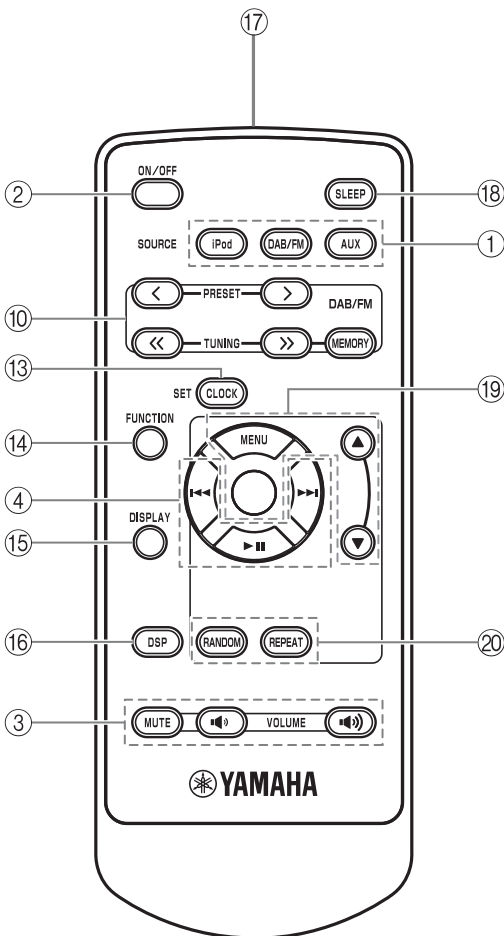
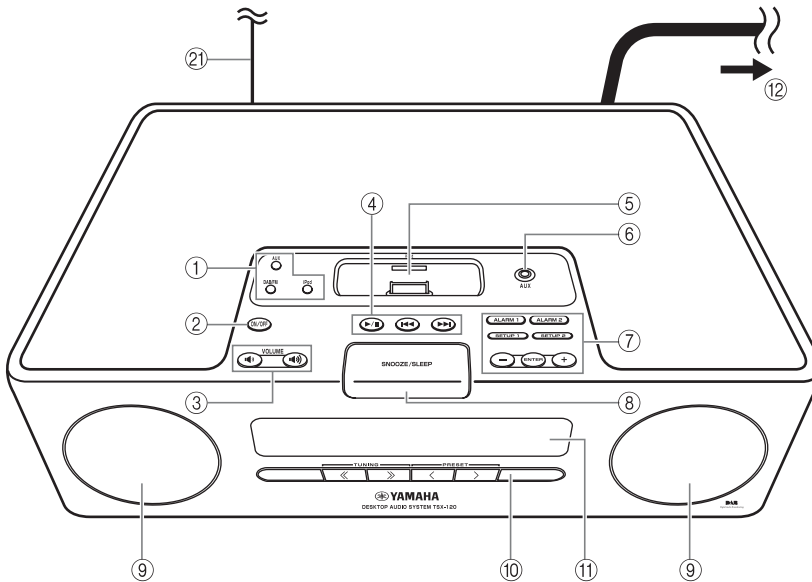

- ① Source buttons: AUX, DAB/FM, iPod (☞ P. 9)
 - ② ON/OFF: System on/off (☞ P. 4)
 - ③ VOLUME: Volume control buttons (☞ P. 9)
 - ④ Audio control buttons (☞ P. 9)
 - ⑤ iPod dock (☞ P. 10)
 - ⑥ AUX in (☞ P. 12)
 - ⑦ Alarm control buttons (☞ P. 5)
 - ⑧ SNOOZE/SLEEP (☞ P. 7, 8)
 - ⑨ Speakers
 - ⑩ DAB/FM control buttons (☞ P. 19)
 - ⑪ Front panel display (☞ P. 4)
 - ⑫ To the wall outlet
 - ⑬ CLOCK SET (☞ P. 4)
 - ⑭ FUNCTION
 - ⑮ DISPLAY (☞ P. 11, 15, 20)
 - ⑯ DSP: DSP mode switching (☞ P. 8)
 - ⑰ Infrared signal transmitter (☞ P. 3)
 - ⑱ SLEEP: Sleep time setting (☞ P. 8)
 - ⑲ MENU ▲/▼/Center buttons* (☞ P. 10)
 - ⑳ RANDOM/REPEAT: Changing the playback mode for iPod (☞ P. 10)
 - ㉑ Indoor DAB/FM antenna
- * The round shaped button on the center is called **Center** in this manual.

■ Before using the remote control

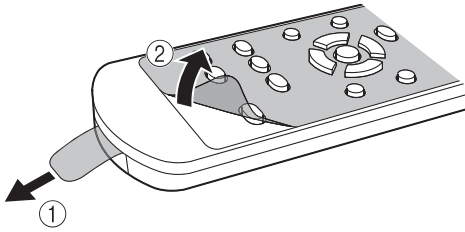

- ① Remove the battery insulation sheet before using the remote control.
- ② Remove the transparent sheet before using the remote control.

■ Using the remote control

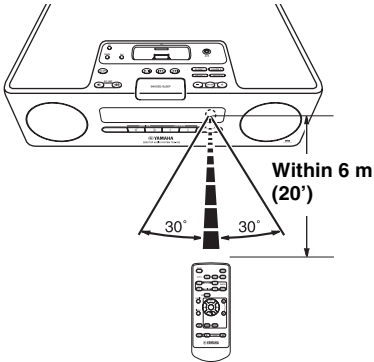

Use the remote control within 6 m (20') of this unit and point it toward the remote control sensor.

Notes

- Do not spill liquid on the remote control.
- Do not drop the remote control.
- Do not leave the remote control in the following places:
 - hot or humid places such as a bathroom or near a heater
 - extremely cold places
 - dusty places

■ Replacing the battery in the remote control

Change the battery when the operation range of the remote control decreases.

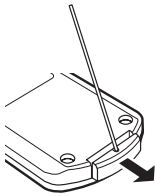

Use a straight pin to remove the cover.

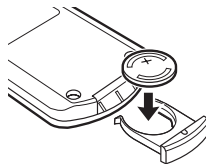

Replace the battery with a new CR2025 battery.

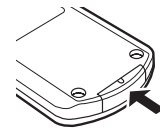

Close the cover.

Notes

- Insert the battery according to the polarity markings (+ and -).
- If the batteries run out, immediately remove them from the remote control to prevent an explosion or acid leak.
- If a battery starts leaking, dispose of it immediately. Be careful not to let the leaking battery acid touch your skin or clothing.
- Before inserting new batteries, wipe the compartment clean.
- Dispose of batteries according to your regional regulations.

Turning on/off the system

1 Connect the power cable to the wall outlet.

2 Press **ON/OFF** to turn on the system.

When the system is on: "Hello" appears, then clock and other information are displayed.

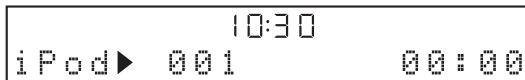

Example: iPod playback mode display

When the system is off: "Good-bye" appears, then only date and time are displayed.



- This unit has an auto off function, which will automatically switch the system to off if the system is left turned on for 1 hour without playback or any other operation being performed. This function is only available when the source is set to iPod.
- Press and hold **ON/OFF** on the top of the unit for more than 3 seconds to set the system to standby mode. All the information on the front panel display is not displayed in standby mode. This can reduce the power consumption. To cancel standby mode, press **ON/OFF**.
- Even in system off/standby mode, the alarm function is available.
- The memory back-up circuit prevents stored data such as the time setting from being lost even in system off/standby mode.

Adjusting the clock

The clock is not set at the factory.

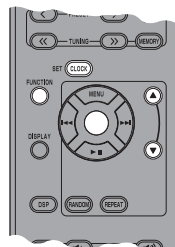

1 Press **CLOCK SET**.



2 Select each setting with **MENU ▲/▼** and confirm with **Center**.

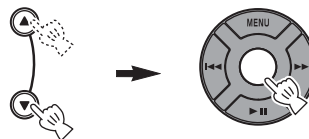

You can set YEAR → MONTH → DAY → TIME.

Notes

- This operation can be performed only with the remote control.
- Time appears in 12-hour notation (AM/PM), depending on the model. For example, "4:00PM".
- You can switch 12-hour/24-hour notation by pressing **FUNCTION** → **MENU ▲/▼** → **Center** to select **TIME FORMAT**, then pressing **MENU ▲/▼** → **Center** to select 12H/24H.
- The time settings are lost after one week when the power cable is disconnected from the wall outlet.

USING USEFUL FUNCTIONS

Using the alarm functions

The unit has the dual alarm function. Each alarm time always appears on the right/left sides of the clock on the front panel display. When the alarm is set to on, the alarm indicator and time light up.

You can set the different music to the alarm from what you listen to during the setting.

Note

This operation can be performed only with the buttons on the top of the unit.



■ Setting the alarm time and sound

Note

To cancel the alarm function setting during the operations, press **SETUP1/SETUP2**. The alarm is not set.

1 Start setting ALARM1/ALARM2.

When you want to set the alarm to **ALARM1**, set on **SETUP1**, and **SETUP2** is for **ALARM2**.

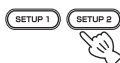

2 Set the alarm time.

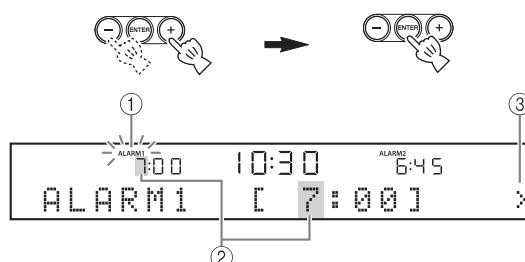

- ① While setting the alarm function, the alarm indicator blinks.
- ② The item you are setting also blinks.
- ③ The > mark on the right side means that you have other menu items on the following screens. You can go to the next menu item setting by pressing **ENTER**.

3 Select and set TYPE → BEEP → SOURCE → VOLUME.



- ① After setting the alarm time, select the alarm type from BEEP/BEEP+MUSIC/MUSIC.
 - BEEP: beep sound only
 - BEEP+MUSIC: beep sound and music selected in an input source, iPod/DAB/FM
 - MUSIC: music only

If you set TYPE to BEEP+MUSIC, you can play back the desired music in an input source, iPod/DAB/FM and beep sound together at the time you set. The music volume gradually increases to wake you up comfortably, and then the beep sound plays back at the time you set.



- ② Select the beep sound.
5 kinds of beep sounds are stored on the unit.
The BEEP screen is skipped automatically if you select MUSIC/BEEP+MUSIC in step ①.



You can preview the currently displayed beep sound by pressing **SNOOZE/SLEEP** when you select the beep sound. To stop the beep sound, press **SNOOZE/SLEEP** again.



- ③ Select the music source from iPod/FM/DAB or LAST SET.



The SOURCE screen is skipped automatically if you select BEEP in step ①.

iPod

You can select PLAYLIST or RESUME PLAY.

The music starts from the beginning of the playlist. Before this operation, make a playlist on your iPod (P. 7).

Select and set PLAYLIST.



Select and set the desired playlist.



Select and set RESUME PLAY when you want to resume the music, which you listen to last time, as the alarm sound.



DAB

Set preset number/station.

FM

Set preset number/frequency.

LAST SET

Keep the setting you set last time.

Note

If the SOURCE is not set completely or the music device is not set, the unit plays back the beep sound instead. For example, if the unit cannot read your iPod, the beep sound plays back.

- ④ Set the alarm volume.

The volume is set with **ENTER** in step ④, then the alarm setting is complete. The alarm is set to on automatically.



Switching on/off the alarm

You can switch on/off the alarm with **ALARM1/ALARM2**, but the alarm settings are not deleted with this operation.

Switch on/off the alarm function.



When the alarm is on, the alarm indicator and time light up.

■ Using the snooze function

When the beep sound, music, or both are played back, you can set the snooze function.

Set the snooze function.

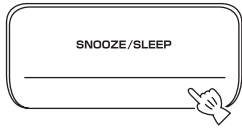

The function differs depending on the alarm type you set in TYPE (P. 5).

BEEP: The beep sound stops by pressing **SNOOZE/SLEEP**, and resumes after 5 minutes.

MUSIC: The music stops by pressing **SNOOZE/SLEEP**, and resumes after 5 minutes.

BEEP+MUSIC: With one click of **SNOOZE/SLEEP**, you can stop the beep sound and keep playing back the music. The beep sound resumes after 5 minutes.



You can also set the snooze function by pressing **SLEEP** on the remote control instead of **SNOOZE/SLEEP** on the unit.

■ Stopping the alarm sound

You can stop the alarm sound in the 3 ways as follows. When you stop alarm sound, the system is set to off.

Press ALARM1/ALARM2.



Press ON/OFF.



Press and hold SNOOZE/SLEEP for 2 seconds.

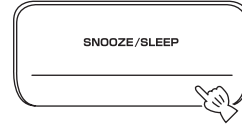

- If you do not stop the alarm, the alarm stops after 60 minutes automatically.
- When you stop the alarm, the alarm indicator disappears. To activate the alarm function again, press **ALARM1/ALARM2** to set the alarm to on.
- When you stop the alarm, the time setting, etc., is saved for convenient use next time.

Note

Any operations other than setting the snooze function, stopping the alarm sound, or adjusting the volume control are not available while playing back the alarm sound.

■ About Playlist

You can collect your favorite songs in the library on your iPod and make a list. This is a playlist. If you select a playlist for playback, the songs in the playlist will be played back. Even if you delete a song in a playlist, it is not deleted from the library.



For more details on playlists, refer to the instruction manual of your iPod.

Setting sleeping mode

You can set the time to turn off the system automatically.

Select the sleep time.



OFF → 30min → 60min → 90min → 120min

When the sleep function is on, the SLEEP indicator lights up.



You can also operate this function with **SLEEP** on the remote control.

Setting Dimmer mode

You can change the brightness of the front panel. If you set DIMMER to AUTO, the dimmer level is adjusted automatically, depending on the brightness of the room. If your room is dark, the front panel becomes darker.

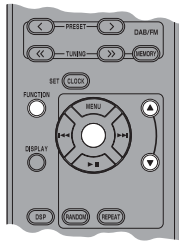

The default setting is AUTO.

1 Select DIMMER from the FUNCTION menu.

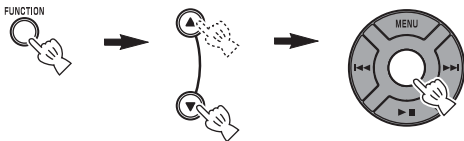

After you select DIMMER with **Center**, < appears on the left side of the front panel display. You can go back to the FUNCTION menu by pressing **MENU** on the remote control.

2 Select the desired dimmer level.

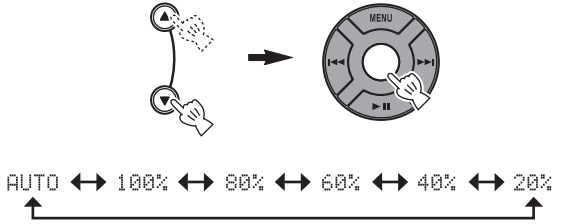

Switching DSP mode

You can switch the sound mode according to the environment or your preference.

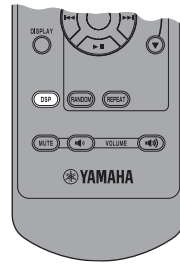

Switch DSP mode.



Press repeatedly.

Each time you press **DSP** the setting switches as follows:

NORMAL: For normal sound



MILD: For natural and mild sound



HEAVY: For more powerful sound
(default setting)



LIVE: For wide realistic sound



Back to NORMAL

BASIC OPERATION



:Press one of the Source buttons to select the desired source.*

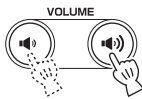
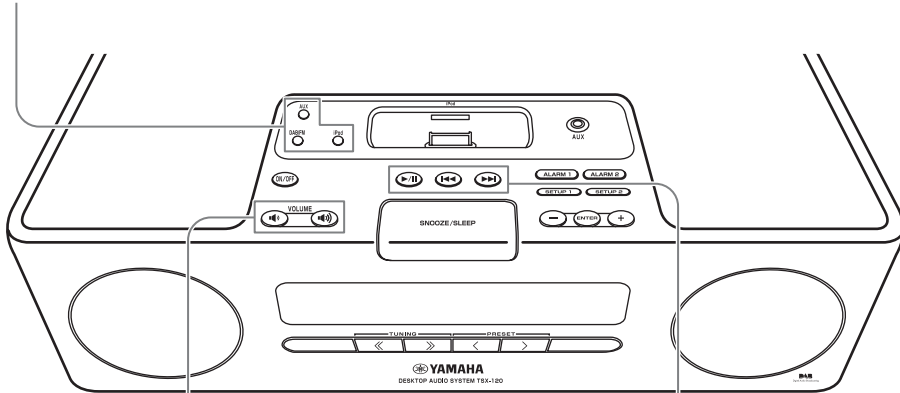

:Press to control the volume.



:Press to play/pause.



: Press to skip backward/forward.

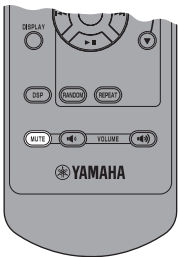

:Press to turn off the sound. Press again to resume the volume.

* Even when the system is off, you can start playback of the desired source by pressing one of the Source buttons, without pressing ON/OFF.

LISTENING TO iPod™ AND EXTERNAL SOURCES

Listening to your iPod™

Notes

- The unit is compatible with iPod touch, iPod (Click Wheel including iPod classic), iPod nano, iPod mini, iPhone and iPhone 3G.
- You can remove your iPod whenever you want.
- Some features may not be available depending on the model or the software version of your iPod.

■ Playing back normally

1 Set your iPod into the iPod dock.

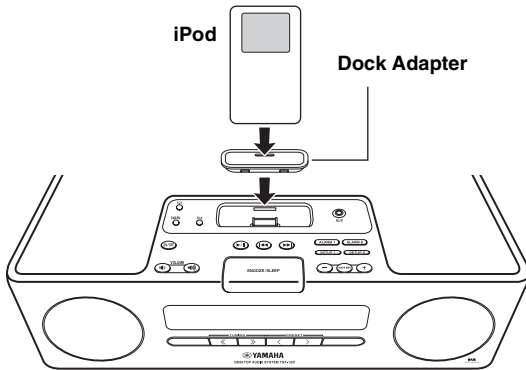

Notes

- A compatible Dock Adapter (not supplied) is required to attach to the unit.
- The iPod may not be set in the iPod dock securely if it is in its protective case.

2 Select iPod.

Playback starts.



For operations of your iPod, refer to the instruction manual of your iPod.

■ Selecting music on iPod with the remote control

You can also operate with your iPod only when LIST DISP is set to iPod (P. 11).

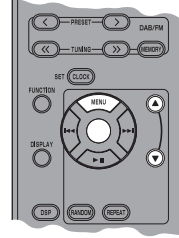

MENU: Go back to the previous menu.

Center: Confirm.

▲/▼: Select menu or items.

■ Using shuffle/repeat mode

After the above steps 1 and 2, you can enjoy shuffle and repeat mode.

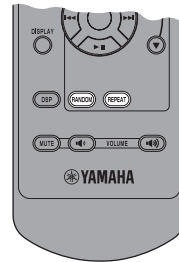

Press RANDOM to switch shuffle mode for iPod.



OFF → ALL → (ALBUM)

Note

You cannot set ALBUM when you use an iPod touch/iPhone.

Switch repeat mode.



OFF → ONE → ALL

■ **Switching the playback information display**



Switch the display in iPod playback mode.



Press repeatedly.

You can change the information display as follows.

Song number and elapsed time (default setting)



Song number and remaining time



Song name



Artist name



Album name



Back to the default setting

Notes

- This function is available for iPod touch, iPod classic, iPod 5th generation or later, iPod nano, iPhone and iPhone 3G. However, even with these models, this function may not be available depending on the software version of your iPod.
- If you intend to disconnect the power cable of the unit for a long time, remove the iPod from the unit.

■ **Switching the playback list display**

LIST DISP allows you to select iPod or the front panel display of the unit to display the list.



Example: When LIST DISP is set to F.PANEL

If you set LIST DISP to iPod, you can also control playback operations and display the menu list on the iPod.

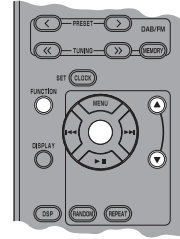

The default setting is iPod.

Note

When LIST DISP is set to F.PANEL, playback operation and menu list displaying are available only on the unit. These operations are not available with your iPod.

1 Select LIST DISP from the FUNCTION menu.

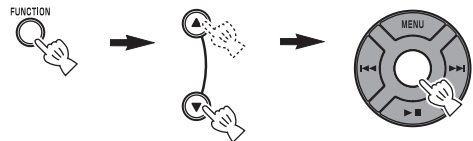

2 Select iPod/F.PANEL.

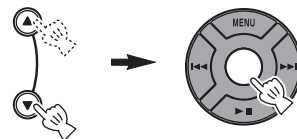

Playing back external sources

■ Playing back normally

- 1 Connect your portable audio device to the AUX terminal using a commercially available 3.5 mm mini plug cable.**

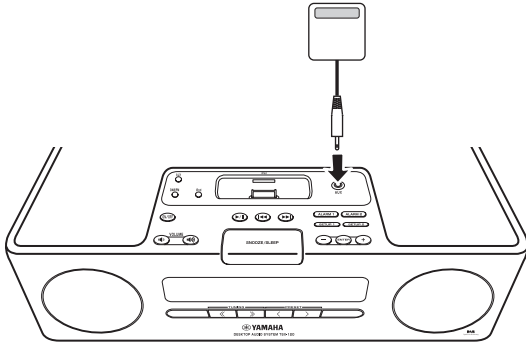

Note

Turn down the volume of this unit and your portable audio device before connection.

- 2 Select AUX.**



- 3 Start playback on the connected portable audio device.**



For operations of the portable audio device, refer to the instruction manual of the device.

LISTENING TO DAB STATIONS

DAB (Digital Audio Broadcasting) uses digital signals for clearer sound and more stable reception compared to analog signals.

DAB is broadcast in blocks of data called ‘ensembles’ containing up to several radio stations that are simultaneously broadcast.

DAB can also include an extensive amount of text information enabling you to select a station by name.

Other information, such as the name of song and artist or several kinds of news can be displayed on the front panel display.

This unit can also receive DAB+ (an upgraded version of DAB) that allows for more stations using MPEG-4 audio codec (AAC+), which has a more efficient transmission method.

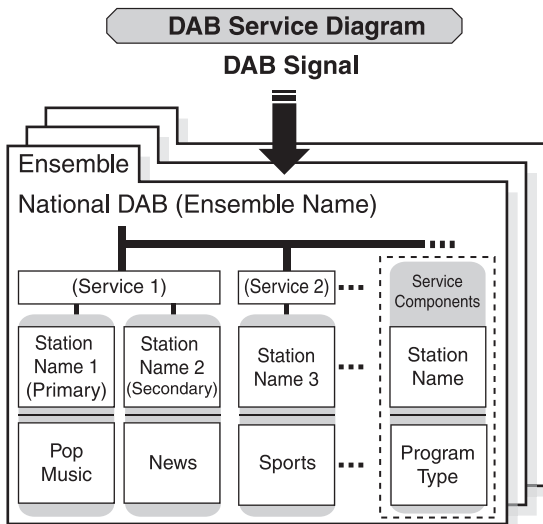

Notes

- Be sure to check the DAB coverage in your area in that not all areas are currently being covered. For a list of nationwide DAB statuses and worldwide DAB frequencies, check WorldDMB Online at “<http://www.worlddab.org/>”.
- The sound quality and station information are controlled by the DAB broadcaster, not this unit. Not all DAB broadcasters transmit station information.
- DAB signals are broadcast in Band III (174 - 240 MHz) and Band L (1452 - 1492 MHz). This unit can receive Band III only.

Setting the antenna

Indoor DAB/FM antenna

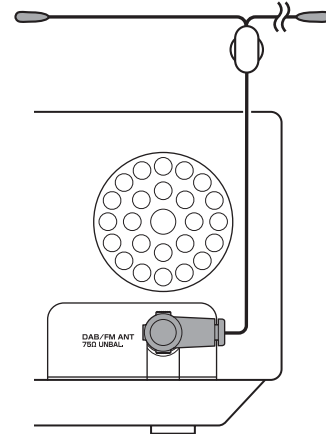

Notes

- The antenna should be stretched out.
- If DAB reception is poor, change the height, direction, or placement of the antenna.

Preparing for DAB reception

Before tuning into DAB stations, an initial scan must be performed.

When you select the DAB as the source for the first time, the initial scan is performed automatically.

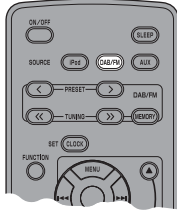

You can also perform the initial scan manually by INIT SCAN (P. 17). To select INIT SCAN, press **FUNCTION** → **MENU** ▲/▼ → **Center** when the source is set to DAB.

1 Turn on DAB.



Pressing the **DAB/FM** button switches the DAB mode to the FM mode, or vice versa.

2 The initial scan starts automatically.

While the scan is in progress, “Scanning” and the > mark appear on the front panel display.

Scanning >>>

When scanning is complete, “Completed” and the number of receivable DAB stations appear on the front panel display.

Completed [15]



10:30
DAB BBC 6 MUSIC-0

Tuning DAB stations

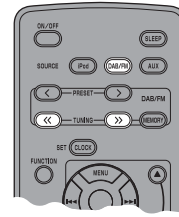

1 Turn on DAB.



2 Select a DAB station.

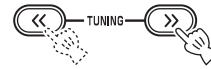

Some stations have sub (secondary) stations. The secondary indicator lights up when a secondary audio station is selected.



You can also use **TUNING**<</> on the front of the unit.

Secondary indicator



You can change the order of DAB stations by STATION ORDER (P. 17). To select STATION ORDER, press **FUNCTION** → **MENU** ▲/▼ → **Center** when the source is set to DAB.

Note

When the unit cannot receive the signal from the selected station, “Off Air” is displayed on the front panel display.

DAB station information

■ Switching the information display of DAB

While receiving DAB, switch the information display.



Press repeatedly.

STATION LABEL



DLS



ENSEMBLE LABEL



PROGRAM TYPE



BITRATE/AUDIO MODE



DATE AND TIME



CHANNEL LABEL/FREQ.



SIGNAL QUALITY



STATUS/AUDIO FORMAT

■ Descriptions of information type

STATION LABEL

Displays the name of the current DAB station.

DLS (Dynamic Label Segment)

Displays information about the current DAB station such as the name of the song, artist and speaker, etc. This data is continuously updated by the DAB broadcaster, thus changing often with every new song or program. Other data, such as news, weather, and sports headlines, may be broadcast as well.

ENSEMBLE LABEL

Displays the name of the current ensemble.

PROGRAM TYPE

Displays the genre of the current DAB station.

BITRATE/AUDIO MODE

Displays the audio mode (stereo or monaural) and bit rate of the current DAB station.

DATE AND TIME

Displays the current date and time.

CHANNEL LABEL/FREQ.

Displays the channel label and frequency of the current DAB station (☞ P. 18).

SIGNAL QUALITY

Displays the signal reception quality (from 0 (none) to 100 (best)) of the current DAB station.

STATUS/AUDIO FORMAT

Displays whether DRC (Dynamic Range Control)* is activated, and the audio format of the current station. "DRC" is displayed when DRC MODE (☞ P. 17) is set to AUTO and DRC information is transmitted by DAB station.

* Some DAB broadcasters transmit a wide dynamic range enabling high quality sound, accompanied by DRC information.

Use this feature to compress the dynamic range of the DAB broadcast. This is especially useful when you listen to a DAB station in a noisy environment or at a low volume at night.



You can change the DRC setting by DRC MODE (☞ P. 17).

To select DRC MODE, press **FUNCTION** → **MENU** ▲/▼ → **Center** when the source is set to DAB.

■ Adjusting the time automatically

This function sets the clock automatically based on DAB or RDS* (P. 20) information.

* U.K. model only

1 Select AUTO CLOCK from the FUNCTION menu.

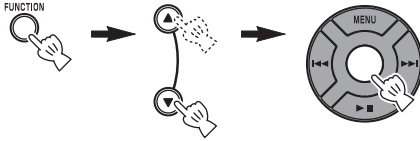

2 Select and set the desired setting.

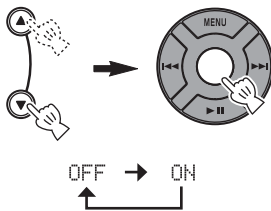

Note

The clock information may differ depending on the received station.

Presetting DAB stations

You can store your favorite DAB stations with the preset function.

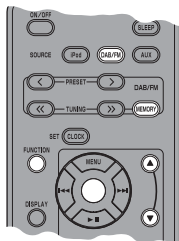

1 Tune into a favorite DAB station.

2 Press MEMORY.



3 Select the preset number you want to store to and complete the preset.

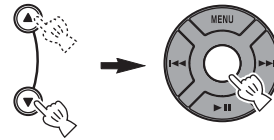

- You can preset up to 30 DAB stations.
- You can delete a preset station by PRESET DELETE (P. 17). To select PRESET DELETE, press **FUNCTION** → **MENU** ▲/▼ → **Center** when the source is set to DAB.

Note

To cancel the preset, press **MEMORY** again.

Selecting preset DAB stations (Preset tuning)

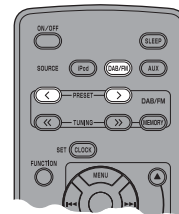

Select a preset DAB station in DAB mode.



You can also use **PRESET** </> on the front of the unit.

Using DAB FUNCTION

You can set the following functions in DAB FUNCTION menu.

Function	Description
PRESET DELETE	Deletes unnecessary preset DAB stations.
STATION ORDER	Enables you to change the station order. ALPHANUMERIC: Stations are listed in alphabetical order. ENSEMBLE: Stations are listed in ensemble order. The default setting is “ALPHANUMERIC”.
DRC MODE	Changes the DRC (☞ P. 15) setting. AUTO: This unit utilizes DRC automatically if it is transmitted. OFF: This unit does not utilize DRC. The default setting is “AUTO”.
DAB CLEAR	Deletes all DAB station information and preset settings stored in the unit. After DAB CLEAR is complete, this unit moves to the INIT SCAN function automatically. Note that once DAB CLEAR is performed, the deleted information and preset settings cannot be restored.
INIT SCAN	Performs the initial scan manually.
TUNE AID	Measures reception strength of the received signal (from 0 (none) to 100 (best)). Refer to “TUNE AID” (☞ P. 18) for this operation.
AUTO CLOCK	Sets the clock status. Refer to “Adjusting the time automatically” (☞ P. 16) for this operation.

The following are operation examples.

■ Operation example 1

PRESET DELETE, STATION ORDER and DRC MODE

1 While receiving DAB, select the function you want to use from the FUNCTION menu.

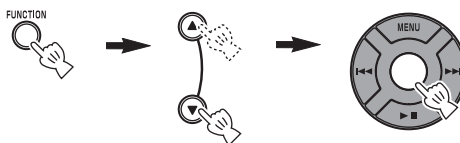

2 Select and set the desired setting.

For PRESET DELETE, select a preset number you want to delete.

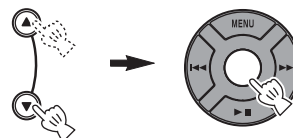

■ Operation example 2

DAB CLEAR and INIT SCAN

1 While receiving DAB, select DAB CLEAR or INIT SCAN from the FUNCTION menu.

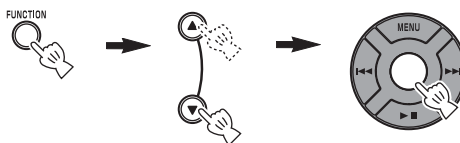

2 To perform the function, press Center.

If you select DAB CLEAR, all DAB information is deleted; when INIT SCAN, the initial scan is initiated.

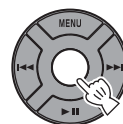

■ TUNE AID

The following explains the TUNE AID operation.

1 While receiving DAB, select TUNE AID from the FUNCTION menu.

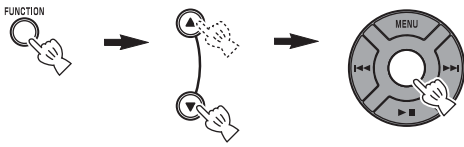

2 Select a channel label you want to measure.



The strength of the received signal is displayed on the front panel display.

3 To finish measuring, press Center.



To check the frequency corresponding to the channel label, refer to “DAB frequency information” (P. 18).

DAB frequency information

This unit can receive Band III only.

Frequency	Channel label
174.928 MHz	5A
176.640 MHz	5B
178.352 MHz	5C
180.064 MHz	5D
181.936 MHz	6A
183.648 MHz	6B
185.360 MHz	6C
187.072 MHz	6D
188.928 MHz	7A
190.640 MHz	7B
192.352 MHz	7C
194.064 MHz	7D
195.936 MHz	8A
197.648 MHz	8B
199.360 MHz	8C
201.072 MHz	8D
202.928 MHz	9A
204.640 MHz	9B
206.352 MHz	9C
208.064 MHz	9D
209.936 MHz	10A
211.648 MHz	10B
213.360 MHz	10C
215.072 MHz	10D
216.928 MHz	11A
218.640 MHz	11B
220.352 MHz	11C
222.064 MHz	11D
223.936 MHz	12A
225.648 MHz	12B
227.360 MHz	12C
229.072 MHz	12D
230.784 MHz	13A
232.496 MHz	13B
234.208 MHz	13C
235.776 MHz	13D
237.488 MHz	13E
239.200 MHz	13F

LISTENING TO FM RADIO STATIONS

Tuning radio stations

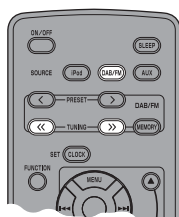

1 Turn on FM.



Pressing the **DAB/FM** button switches the FM mode to the DAB mode, or vice versa.

2 Start automatic tuning.



Press and hold.



- If the signal received from the station you want to select is weak, you can also tune into radio stations manually by pressing **TUNING** repeatedly.
- You can also use **TUNING** on the front of the unit.

Notes

- If you tune to a station manually, the sound is monaural.
- If radio reception is poor, change the height, direction, or placement of the antenna.

Presetting radio stations

You can store your favorite FM stations with the preset function.

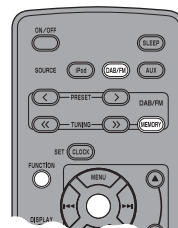

Auto preset

1 Press and hold MEMORY for more than 2 seconds in FM mode.



2 Start the auto preset.

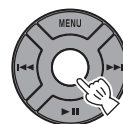

Manual preset

1 Tune into a favorite radio station.

2 Press MEMORY.



3 Select the preset number you want to store to.



Note

To cancel the manual preset, press **MEMORY** again.

4 Complete the manual preset.



- You can preset up to 30 FM stations.
- You can delete a preset station by pressing **FUNCTION** → **MENU** ▲/▼ → **Center** to select PRESET DELETE.

Note

When you perform the auto preset, all stored stations are cleared and the new stations are stored.

Selecting preset radio stations (Preset tuning)

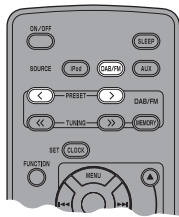

Select the preset radio station in FM mode.



You can also use **PRESET** </> on the front of the unit.

Receiving Radio Data System stations (U.K. model only)

Switching the information display of Radio Data System

While receiving Radio Data System,
switch the information display.



Press repeatedly.

Station name



Program type



Text information related to the station



Current time



Original display



Status display

Note

If the signal transmission of the Radio Data System station is too weak, this unit may not be able to receive Radio Data System information completely. In particular, RT (Radio Text) information uses a lot of bandwidth, so it may be less available compared to other types of information.

TROUBLESHOOTING

In case of a problem with the unit, check the following list first. If you cannot solve your problem with the suggested solutions or if your problem is not listed below, turn off and unplug the unit, and consult the nearest authorized Yamaha dealer or service center.

General

Problem	Cause	Solution
The system turns on but immediately shuts off.	The power cable may be connected improperly.	Make sure the power cable is plugged into the wall outlet firmly.
	The unit may have received a strong electrical shock such as lightning or excessive static electricity.	Set the system to off, and disconnect the power cable. Wait about 30 seconds, reconnect the power cable, and turn on the system.
The speakers make no sound.	The volume may be set to the minimum level.	Adjust the volume level (P. 9).
	The mute function may be on.	Cancel the mute function (P. 9).
	The source may be incorrect.	Select the correct source (P. 9).
Sound suddenly turns off.	The sleep timer (P. 8) may be set.	Turn on the system and play the source again.
The unit does not operate properly.	The unit may have received a strong electrical shock such as lightning or excessive static electricity, or power supply may have dropped.	Set the system to off, and disconnect the power cable. Wait about 30 seconds, reconnect the power cable, and turn on the system.
A digital or high-frequency equipment produces noises.	The unit may be placed too close to the digital or high-frequency equipment.	Place the unit farther away from the equipment.
The clock setting has been cleared.	The unit is left more than one week after you disconnect the power cable from the wall outlet.	Plug the power cable into the wall outlet firmly, and set the clock again (P. 4).

iPod™

Problem	Cause	Solution
“iPod Connect Error” appears on the front panel display.	There is a problem with communication between the unit and your iPod.	Turn off the system and reconnect your iPod to the unit.
The iPod does not charge up.	The iPod is set in the iPod dock improperly.	Remove the iPod from the unit, then set it in the iPod dock again.
“iPod Not Connected” appears on the front panel display after you set the iPod.		
The iPod makes no sound.		
The iPod sounds, but you cannot operate it with the unit or the remote control.		

Problem	Cause	Solution
You cannot operate from the iPod.	LIST DISP is set to F.PANEL.	Set LIST DISP to iPod from the FUNCTION menu (P. 11).
The playback information is not displayed on the front panel display.	The iPod you set is not compatible with the playback information display.	Only iPod touch, iPod classic, iPod 5 th generation or later, iPod nano, iPhone and iPhone 3G are compatible with the function.
“Unknown iPod” appears on the front panel display after you set the iPod.	The iPod being used is not supported by the unit.	Only iPod touch, iPod (Click Wheel, including iPod classic), iPod nano, iPod mini, iPhone and iPhone 3G are supported.

DAB reception

Problem	Cause	Solution
Cannot tune into any DAB stations.	The initial scan operations were not performed.	Perform the initial scan operations (P. 14).
	There is no DAB coverage in your area.	Check with your dealer or WorldDMB Online at “ http://www.worlddab.org ” for a listing of the DAB coverage in your area.
	The DAB signals are too weak.	Change the height, direction, or placement of the indoor DAB/FM antenna.
The initial scan operations are not successful and “Not found” appears on the front panel display.	The DAB signals are too weak.	Change the height, direction, or placement of the indoor DAB/FM antenna.
	There is no DAB coverage in your area.	Check with your dealer or WorldDMB Online at “ http://www.worlddab.org ” for a listing of the DAB coverage in your area.
The DAB station reception is weak.	The positioning of the indoor DAB/FM antenna and/or this unit is not optimal for DAB reception.	Use the TUNE AID feature to locate the best positioning of the DAB/FM antenna and this unit for optimal DAB reception (P. 18).
	The DAB signals are too weak.	Change the height, direction, or placement of the indoor DAB/FM antenna.
There is noise interference (e.g. hiss, crackle or jitter).	The indoor DAB/FM antenna needs to be repositioned.	Readjust the position of the indoor DAB/FM antenna.
	The DAB signals are too weak.	Change the height, direction, or placement of the indoor DAB/FM antenna.
The DAB station information does not appear or is inaccurate.	The DAB station may be temporarily out of service, or the DAB station information is not provided by the DAB broadcaster.	Contact the DAB broadcaster.

Radio reception

Problem	Cause	Solution
The preset selecting function does not work.	The preset (memory) may have been erased.	Preset radio stations again (P. 19).
Too much noise during stereo broadcast.	The radio station you selected may be far from your area, or the radio wave reception is weak in your area.	Try manual tuning to improve the signal quality (P. 19).

Remote control

Problem	Cause	Solution
The remote control does not work properly.	The remote control may be operated outside its operation range.	For information on the remote control operation range, refer to "Using the remote control" (P. 3).
	The remote control sensor on the unit may be exposed to direct sunlight or lighting (inverted fluorescent lamps).	Change the lighting or orientation of the unit.
	The battery may be worn out.	Replace the battery with a new one (P. 3).
	There are obstacles between the sensor of the unit and the remote control.	Remove the obstacles.

SPECIFICATIONS

■ PLAYER SECTION

iPod

- Supported iPod..... iPod touch, iPod (Click Wheel including iPod classic), iPod nano, iPod mini, iPhone, iPhone 3G

AUX IN

- Input connectorSTEREO L/R: 3.5 Φ STEREO mini Jack

■ AMPLIFIER SECTION

- Maximum output power 15 W + 15 W
(6 Ω 1 kHz, 10% THD)
- Driver unit.....8 cm (3") full-range driver \times 2

■ TUNER SECTION

- Tuning range
FM 87.5 to 108.0 MHz
DAB 174 to 240 MHz (Band III)

■ GENERAL

- Power Supply AC 230 to 240 V, 50 Hz
- Power consumption 20 W
- Standby Power consumption 1.0 W or less
- Dimensions (W \times H \times D) 350 \times 120 \times 275 mm
(13 3/4 \times 4 3/4 \times 10 7/8 in)
(including indoor DAB/FM antenna)
- Weight 3.7 kg (8.2 lbs.)

Specifications are subject to change without notice.

iPod™

“iPod” is a trademark of Apple, Inc., registered in the U.S. and other countries.

“iPhone” is a trademark of Apple Inc.

“Made for iPod” means that an electronic accessory has been designed to connect specifically to iPod and has been certified by the developer to meet Apple performance standards.

“Works with iPhone” means that an electronic accessory has been designed to connect specifically to iPhone and has been certified by the developer to meet Apple performance standards.

Apple is not responsible for the operation of this device or its compliance with safety and regulatory standards.



Digital Audio Broadcasting

This unit supports DAB tuning.

Limited Guarantee for European Economic Area (EEA) and Switzerland

Thank you for having chosen a Yamaha product. In the unlikely event that your Yamaha product needs guarantee service, please contact the dealer from whom it was purchased. If you experience any difficulty, please contact Yamaha representative office in your country. You can find full details on our website (<http://www.yamaha-hifi.com/> or <http://www.yamaha-uk.com/> for U.K. resident).

The product is guaranteed to be free from defects in workmanship or materials for a period of two years from the date of the original purchase. Yamaha undertakes, subject to the conditions listed below, to have the faulty product or any part(s) repaired, or replaced at Yamaha's discretion, without any charge for parts or labour. Yamaha reserves the right to replace a product with that of a similar kind and/or value and condition, where a model has been discontinued or is considered uneconomic to repair.

Conditions

1. The original invoice or sales receipt (showing date of purchase, product code and dealer's name) MUST accompany the defective product, along with a statement detailing the fault. In the absence of this clear proof of purchase, Yamaha reserves the right to refuse to provide free of charge service and the product may be returned at the customer's expense.
2. The product MUST have been purchased from an AUTHORISED Yamaha dealer within the European Economic Area (EEA) or Switzerland.
3. The product must not have been the subject of any modifications or alterations, unless authorised in writing by Yamaha.
4. The following are excluded from this guarantee:
 - a. Periodic maintenance and repair or replacement of parts due to normal wear and tear.
 - b. Damage resulting from:
 - (1) Repairs performed by the customer himself or by an unauthorised third party.
 - (2) Inadequate packaging or mishandling, when the product is in transit from the customer. Please note that it is the customer's responsibility to ensure the product is adequately packaged when returning the product for repair.
 - (3) Misuse, including but not limited to (a) failure to use the product for its normal purpose or in accordance with Yamaha's instructions on the proper use, maintenance and storage, and (b) installation or use of the product in a manner inconsistent with the technical or safety standards in force in the country where it is used.
 - (4) Accidents, lightning, water, fire, improper ventilation, battery leakage or any cause beyond Yamaha's control.
 - (5) Defects of the system into which this product is incorporated and/or incompatibility with third party products.
 - (6) Use of a product imported into the EEA and/or Switzerland, not by Yamaha, where that product does not conform to the technical or safety standards of the country of use and/or to the standard specification of a product sold by Yamaha in the EEA and/or Switzerland.
 - (7) Non AV (Audio Visual) related products.
(Products subject to "Yamaha AV Guarantee Statement" are defined in our website at <http://www.yamaha-hifi.com/> or <http://www.yamaha-uk.com/> for U.K. resident.)
5. Where the guarantee differs between the country of purchase and the country of use of the product, the guarantee of the country of use shall apply.
6. Yamaha may not be held responsible for any losses or damages, whether direct, consequential or otherwise, save for the repair or replacement of the product.
7. Please backup any custom settings or data, as Yamaha may not be held responsible for any alteration or loss to such settings or data.
8. This guarantee does not affect the consumer's statutory rights under applicable national laws in force or the consumer's rights against the dealer arising from their sales/purchase contract.

Information for Users on Collection and Disposal of Old Equipment and Used Batteries



These symbols on the products, packaging, and/or accompanying documents mean that used electrical and electronic products and batteries should not be mixed with general household waste.

For proper treatment, recovery and recycling of old products and used batteries, please take them to applicable collection points, in accordance with your national legislation and the Directives 2002/96/EC and 2006/66/EC.



By disposing of these products and batteries correctly, you will help to save valuable resources and prevent any potential negative effects on human health and the environment which could otherwise arise from inappropriate waste handling.



For more information about collection and recycling of old products and batteries, please contact your local municipality, your waste disposal service or the point of sale where you purchased the items.

[Information on Disposal in other Countries outside the European Union]

These symbols are only valid in the European Union. If you wish to discard these items, please contact your local authorities or dealer and ask for the correct method of disposal.



Note for the battery symbol (bottom two symbol examples):

This symbol might be used in combination with a chemical symbol. In this case it complies with the requirement set by the Directive for the chemical involved.

Pb



YAMAHA CORPORATION
Printed in Malaysia Y WQ45800