



Network Player

NP-S303

Owner's Manual

This product is designed for use at home to enjoy listening to audio.

musicCast

PRECAUTIONS

PLEASE READ CAREFULLY BEFORE USE. BE SURE TO FOLLOW THESE INSTRUCTIONS.

The precautions listed below are to prevent risk of harm to the user and others, as well as to prevent property damage, and to help the user use this unit properly and safely. Be sure to follow these instructions.

After reading this manual, be sure to keep it in a safe place where it can be referenced at any time.

- Be sure to request inspections or repairs from the dealer where you purchased the unit or from qualified Yamaha service personnel.
- Yamaha cannot be held responsible for damage caused by improper use or modifications to the unit.
- This product is for ordinary homes. Do not use for applications requiring high reliability, such as managing lives, health care or high-value assets.



WARNING
This content indicates “risk of serious injury or death.”

Power supply/power cord

- Do not do anything that could damage the power cord.
 - Do not place it near a heater.
 - Do not bend it excessively or alter it.
 - Do not scratch it.
 - Do not place it under a heavy object.Using the power cord with the core of the cord exposed could cause electric shocks or a fire.
- Do not touch the power plug or cord if there is a chance of lightning. Failure to observe this may cause electric shocks.
- Use this unit with the power supply voltage printed on it. Failure to connect to an appropriate AC outlet may cause a fire, electric shocks, or malfunctions.
- Be sure to use the supplied power cord. Also, do not use the supplied power cord for other units. Failure to observe the above may cause a fire, burns, or malfunctions.
- Check the electric plug periodically and remove any dirt or dust which may have accumulated on it. Failure to observe this may cause a fire or electric shocks.

- When setting up the unit, make sure that the AC outlet you are using is easily accessible. If some trouble or malfunction occurs, immediately turn off the power switch and disconnect the plug from the AC outlet. Even when the power switch is turned off, as long as the power cord is not unplugged from the wall AC outlet, the unit will not be disconnected from the power source.
- If you hear thunder or suspect approaching lightning, quickly turn off the power switch and pull the power plug from the AC outlet. Failure to observe this may cause a fire or malfunctions.
- If not using the unit for long periods of time, be sure to pull the power plug from the AC outlet. Failure to observe this may cause a fire or malfunctions.

Do not disassemble

- Do not disassemble or modify this unit. Failure to observe this may cause a fire, electric shocks, injury, or malfunctions. If you notice any irregularities, be sure to request an inspection or repair from the dealer where you purchased the unit or from qualified Yamaha service personnel.

Water warning

- Do not expose the unit to rain, use it near water or in damp or wet conditions, or place on it any containers (such as vases, bottles or glasses) containing liquids which might spill into any openings. A liquid such as water getting into the unit may cause a fire, electric shocks, or malfunctions. If any liquid such as water seeps into the device, turn off the power of the amplifier immediately and unplug the power cord from the AC outlet. Then, request an inspection from the dealer where you purchased the unit or from qualified Yamaha service personnel.
- Never insert or remove an electric plug with wet hands. Do not handle this unit with wet hands. Failure to observe this may cause electric shocks or malfunctions.

Fire warning

- Do not place any burning items or open flames near the unit, since they may cause a fire.

Battery use

- Do not disassemble a battery. If the contents of the battery get on your hands or in your eyes, it can cause blindness or chemical burns.
- Do not dispose of batteries in fire. Doing so may result in the battery bursting, causing a fire or injury.
- Do not expose a battery to high temperatures, such as direct sunlight or a fire. The battery may burst, causing a fire or injury.
- Do not attempt to recharge batteries that are not intended to be charged. Charging could cause the battery to burst or leak, which can cause blindness, chemical burns, or injury.
- If the batteries do leak, avoid contact with the leaked fluid. If the battery fluid should come in contact with your eyes, mouth, or skin, wash immediately with water and consult a doctor. Battery fluid is corrosive and may possibly cause loss of sight or chemical burns.

Wireless unit

- Do not use this unit near medical devices or inside medical facilities. Radio waves from this unit may affect electro-medical devices.
- Do not use this unit within 15 cm (6 in) of persons with a heart pacemaker implant or a defibrillator implant. Radio waves from this unit may affect electro-medical devices, such as a heart pacemaker implant or defibrillator implant.

If you notice any abnormality

- If any of the following abnormalities occur, immediately turn off the power and disconnect the power plug.
 - The power cord/plug is damaged.
 - An unusual smell or smoke is emitted from the unit.
 - Foreign material gets into the interior of the unit.
 - There is a loss of sound during use.
 - There is a crack or damage in the unit.Continued use could cause electric shocks, a fire, or malfunctions. Immediately request an inspection or repair from the dealer where you purchased the unit or from qualified Yamaha service personnel.
- Be careful not to drop or apply strong impact to this unit. If you suspect the unit may have been damaged due to dropping or impact, immediately turn off the power and pull the power plug from the AC outlet. Failure to observe this may cause electric shocks, a fire, or malfunctions. Immediately request an inspection from the dealer where you purchased the unit or from qualified Yamaha service personnel.



CAUTION

This content indicates “risk of injury.”

Power supply/power cord

- Do not use an AC outlet where the power plug fits loosely when inserted. Failure to observe this may cause a fire, electric shocks, or burns.
- When removing the electric plug from the unit or an AC outlet, always hold the plug itself and not the cord. Pulling by the cord can damage it and cause electric shocks or a fire.
- Insert the power plug firmly all the way into the AC outlet. Using the unit when it is not plugged in sufficiently can cause dust to accumulate on the plug, causing a fire or burns.

Installation

- Do not place the unit in an unstable position where it might accidentally drop or fall over and cause injuries.
- When installing this unit:
 - Do not cover it with any cloth.
 - Do not install it on a carpet or rug.
 - Make sure the top surface faces up; do not install on its sides or upside down.
 - Do not use the device in a confined, poorly-ventilated location.

Failure to observe the above may trap heat inside the unit, causing a fire or malfunctions. Ensure that there is adequate space around the unit: at least 10 cm (3-7/8 in) on top, 10 cm (3-7/8 in) on the sides, and 10 cm (3-7/8 in) on the rear.

- Ensure that the top is facing upwards. Failure to observe this may cause malfunctions or for the unit to fall and cause injury.

- Do not install the unit in places where it may come into contact with corrosive gases or salt air. Doing so may result in malfunction.
- Avoid being near the unit during a disaster, such as an earthquake. Since the unit may fall and cause injury, quickly move away from the unit and go to a safe place.
- Before moving this unit, be sure to turn off the power switch and disconnect all connection cables. Failure to observe this may damage the cables or cause you or someone else to trip and fall.

Hearing loss

- Before connecting the unit to other devices, turn off the power for all devices. Failing to do so may result in hearing loss, electric shock, or device damage.
- When turning on the AC power in your audio system, always turn on the amplifier or receiver LAST, to avoid hearing loss and speaker damage. When turning the power off, the amplifier or receiver should be turned off FIRST for the same reason. Failure to observe the above may cause hearing impairment or speaker damage.

Maintenance

- Remove the power plug from the AC outlet when cleaning the unit. Failure to observe this may cause electric shocks.

Handling caution

- Do not insert foreign materials such as metal or paper into panel slits of this unit. Failure to observe this may cause a fire, electric shocks, or malfunctions. If foreign material gets into the unit, immediately shut off the power and pull the power plug from the AC outlet and request an inspection from the dealer where you purchased the unit or from qualified Yamaha service personnel.
- Do not do the following:
 - stand on or sit on the equipment.
 - put heavy items on top of the equipment.
 - place the equipment in a stack.
 - apply unreasonable force to buttons, switches, input/output terminals, etc.
 - hang on the equipment.
 - lean against the equipment.
- Avoid pulling the connected cables to prevent injuries or damage to the unit.

Battery use

- Always replace all batteries at the same time. Do not use new batteries together with old ones. Using new ones with old ones could cause a fire, burns, or inflammation due to fluid leaks.
- Do not use batteries other than specified batteries. Doing so cause fire, burns, or inflammation due to leakage.
- Do not mix battery types, such as alkaline batteries with manganese batteries, or batteries from different makers, or different types of batteries from the same maker, since this can cause a fire, burns, or inflammation due to fluid leaks.

- Keep batteries away from children. A child could accidentally swallow a battery. Failure to observe this may also cause inflammation due to battery fluid leaks.
- Do not put in a pocket or bag, carry, or store batteries together with pieces of metal. The battery could short, burst, or leak, causing a fire or injury.
- Always make sure all batteries are inserted in conformity with the +/- polarity markings. Failure to do so might result in a fire, burns, or inflammation due to fluid leaks.
- When the batteries run out, or if the unit is not to be used for a long time, remove the batteries from the remote control to prevent possible leakage of the battery fluid.
- When storing or discarding batteries, insulate the terminal area by applying tape, or some other protection. Mixing them with other batteries or metal objects can cause a fire, burns, or inflammation due to fluid.

Notice and Information

Notice

Indicates points that you must observe in order to prevent product failure, damage or malfunction and data loss, as well as to protect the environment.

❑ Power cord

- If not using the unit for a long period of time, be sure to pull the power plug from the outlet. Even if the [⏻] (power) has been turned off, a minute current is still flowing.

❑ Installation

- Do not use this unit in the vicinity of other electronic equipment, such as a TV, radio, AV unit, or mobile phone. Failure to observe this may cause this unit or the TV or radio to produce noise.
- Do not use this unit in a location that is exposed to direct sunlight (such as a vehicle interior), that becomes extremely hot, such as near a heater, or extremely cold, or that is subject to excessive dust or vibration. Failure to observe this may cause the unit's panel to become deformed, the internal components to malfunction, or for operation to become unstable.
- Install this unit as far away from other electronic equipment as possible. Digital signals from this unit may interfere with other electronic equipment.

- If using a wireless network or *Bluetooth*, avoid installing this unit near metal walls or desks, microwave ovens, or other wireless devices. Obstructions could shorten the transmission distance.

❑ Connections

- If connecting external units, be sure to thoroughly read the manual for each unit and connect them in accordance with the instructions. Failure to properly handle a unit in accordance with the instructions could cause malfunctions.
- Do not connect this unit to industrial units. Digital audio interface standards for consumer use and industrial use are different. This unit has been designed to connect to a consumer-use digital audio interface. Connections to an industrial-use digital audio interface could not only cause this unit to malfunction, but could also damage the speakers.

❑ Handling

- Do not place vinyl, plastic, or rubber products on this unit. Failure to observe this may cause discoloration or deformation in the panel of this unit.
- If the ambient temperature changes drastically (such as during unit transportation or under rapid heating or cooling) and there is a chance condensation may have formed in the unit, leave the unit for several hours without turning on the power until it is completely dry before use. Using the unit while there is condensation can cause malfunctions.

❑ Maintenance

- When cleaning the unit, use a dry, soft cloth. Using chemicals such as benzene or thinner, cleaning agents, or chemical scrubbing cloths can cause discoloration or deformation.

❑ Batteries

- Be sure to discard used batteries in accordance with local regulations.

Information

Indicates information of note regarding this product.

About content in this manual

- The illustrations and screens in this manual are for instructional purposes only.
- The company names and product names in this manual are the trademarks or registered trademarks of their respective companies.

CONTENTS

BEFORE USING THE UNIT 10

Accessories 10

About this manual..... 10

FEATURES 11

What you can do with the unit..... 11

Using the MusicCast CONTROLLER app..... 12

Part names and functions..... 13

Front panel..... 13

Rear panel..... 14

Remote control..... 15

PREPARATION 17

1 Connecting to an amplifier..... 17

2 Preparing to connect to a network..... 18

Connecting a network cable..... 18

Preparing a wireless antenna..... 18

3 Connecting the power cord..... 19

4 Turning on the power to the unit..... 19

Turning on the power to the unit for the first time..... 19

5 Connecting the unit to the network..... 20

Connecting to a network by using MusicCast CONTROLLER..... 20

Connecting to a network using another method..... 22

Connecting a mobile device to the unit directly (Wireless Direct)..... 27

Verifying the network connection status..... 28

PLAYING AUDIO 29

Listening to Internet radio..... 29

Selecting an Internet radio station..... 29

Playing music files stored on your USB device..... 30

Connecting a USB storage device..... 30

Playing songs stored on a USB storage device..... 30

Playing music files stored on a media server (PC/NAS)..... 32

Media sharing setup..... 32

Selecting and playing music stored on a PC (or server)..... 33

Listening to music via AirPlay..... 34

Playing a song from iTunes/iPhone..... 34

Listening to music via *Bluetooth*..... 36

Playing audio from *Bluetooth* devices on the unit..... 36

Playing audio from this unit through *Bluetooth*-compatible speakers or headphones... 37

Useful functions..... 38

Switching information on the display..... 38

Registering favorite content (Preset function)..... 38

Displaying audio signal information..... 39

Enabling/disabling automatic playback..... 40

Setup 41

Configuring various functions (Setup menu)41

Setup menu items 41

Configuring the system settings (Advanced Setup menu)45

Viewing the firmware version (VERSION)..... 45

Initializing the unit (INIT) 45

Updating the firmware (UPDATE)..... 45

Updating the unit's firmware via the network46

APPENDIX 47

Troubleshooting47

General..... 47

Bluetooth 48

USB/Network 49

Display messages51

Supported devices and file formats.....52

Trademarks.....53

Specifications.....54

BEFORE USING THE UNIT

Accessories

Make sure that the following accessories are supplied with the product.

Remote control

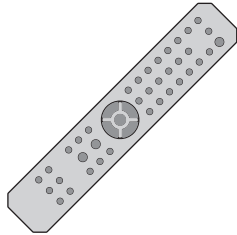

Power cord

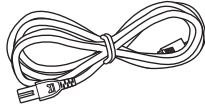

* The supplied power cord varies depending on the region of purchase.

RCA stereo cable

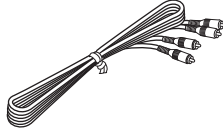

Batteries (x2)
(AA, R03, UM-4)

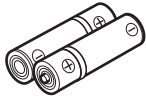

Owner's Manual

Inserting batteries into the remote control

Insert the batteries in the proper orientation.

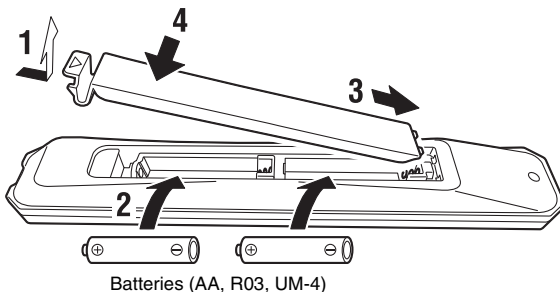

About this manual

Please note the following when you read this manual:

- This manual explains preparations and operations for everyday users of the unit.
- Due to product improvements, specifications and appearance are subject to change without notice.
- This manual explains operations performed primarily on the supplied remote control.
- In this manual, illustrations of English menu screens are used as examples.
- In this manual, iPhone, iPad and iPod touch are collectively referred to as "iPhone". Unless otherwise noted, the term "iPhone" as used in this manual also refers to an iPhone, iPad, or iPod touch.
- Explanation of graphic symbols used in this manual:
 - **⚠ WARNING** is intended to alert you to the possibility of death or serious injury.
 - **⚠ CAUTION** is intended to alert you to the possibility of personal injury.
 - **NOTICE** is intended to provide information to avoid product malfunction, damages, incorrect operation, or data loss.
 - **NOTE** is intended to provide supplemental information that might be handy.
- For details on streaming services, visit the following website:
<http://download.yamaha.com/>

FEATURES

What you can do with the unit

This unit is a network player compatible with a network source such as a media server or mobile device.

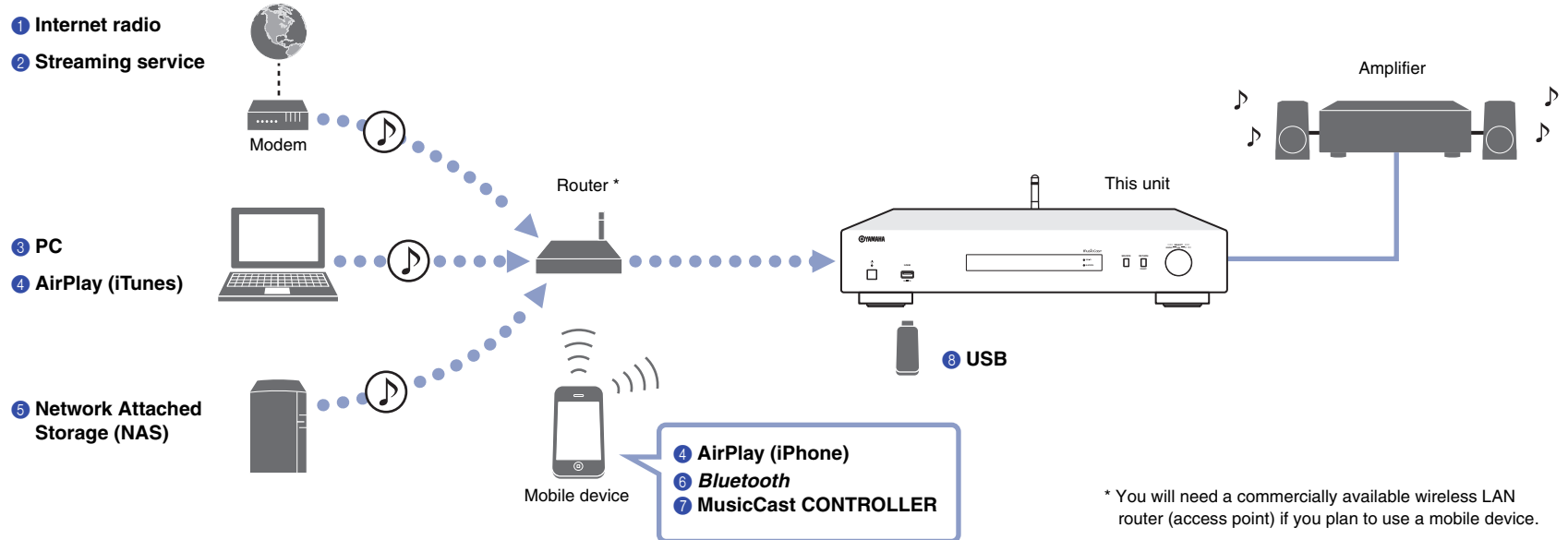

- 1 Listening to Internet radio (page 29)
- 2 Listening to Streaming service
- 3 Playing music files stored on your PC (page 33)
- 4 Playing music files with AirPlay (page 34)

- 5 Playing music files stored on a Network Attached Storage (NAS) device (page 33)
- 6 Playing audio content from a *Bluetooth* device (page 36)
- 7 Playing music using MusicCast CONTROLLER (page 20)
- 8 Playing music files stored on your USB device (page 30)

Using the MusicCast CONTROLLER app

Using the free MusicCast CONTROLLER app installed on a mobile device enables you to use your mobile device like a remote control to set up and operate MusicCast-compatible devices. You can also share and play music on multiple MusicCast-compatible devices located in different rooms.

For more information on MusicCast CONTROLLER, visit the following website:
<http://www.yamaha.com/musiccast/>



Download and install the (free) MusicCast CONTROLLER app to your mobile device from the App Store or Google Play.

Use the MusicCast CONTROLLER app to configure a network (MusicCast network) as shown below:

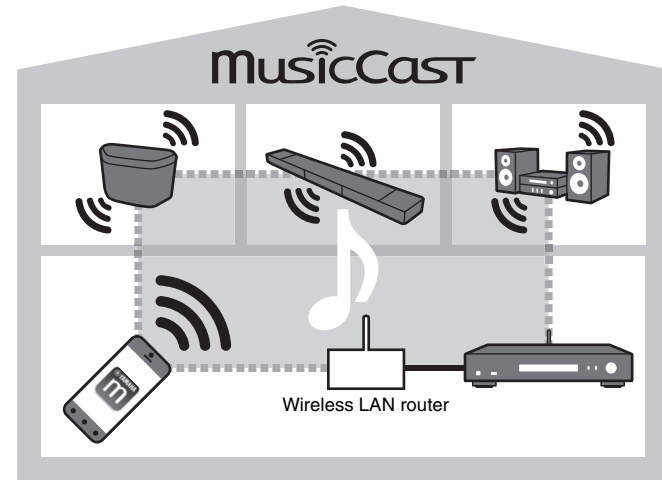

* If you use this unit to play audio from another MusicCast-compatible device, "MC Link" will appear on the unit's display.

Part names and functions

Front panel

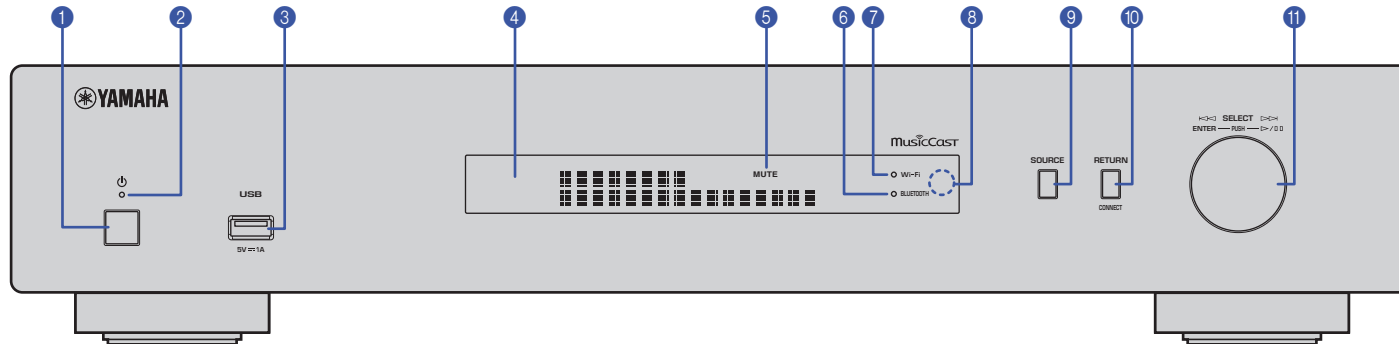

1 Power button

Turns on/off the unit.

2 Power indicator

Indicates the unit's power status.

Brightly lit: Power is on

Dimly lit: Standby mode

Off: Power is off

3 USB jack

Used to connect a USB device (page 30).

4 Display

Shows information about the operational status of this unit.

5 MUTE

Blinks when audio is muted.

6 Bluetooth indicator

Lights up when the unit connects to a *Bluetooth* device (page 36).

7 Wi-Fi indicator

Lights up when the unit is:

- connecting to a wireless network (page 22).
- registering with MusicCast, even if the unit is connected to a wired connection (page 20).
- connecting to a wireless network using Wireless Direct (page 27).

8 Remote control sensor

Receives infrared signals from the remote control.

9 SOURCE

Switches the unit's audio source.

10 RETURN

Displays the next higher level of the menu.

CONNECT

Use this button to operate the unit via the MusicCast CONTROLLER (page 20).

11 Jog dial

To select a menu item or song

Rotate the dial to select an item, then press it to confirm the selection.

To control playback of the music stored on the USB device, PC, or server

Rotate the dial to skip to the previous or next song. Press the dial to switch between play and pause.

Rear panel

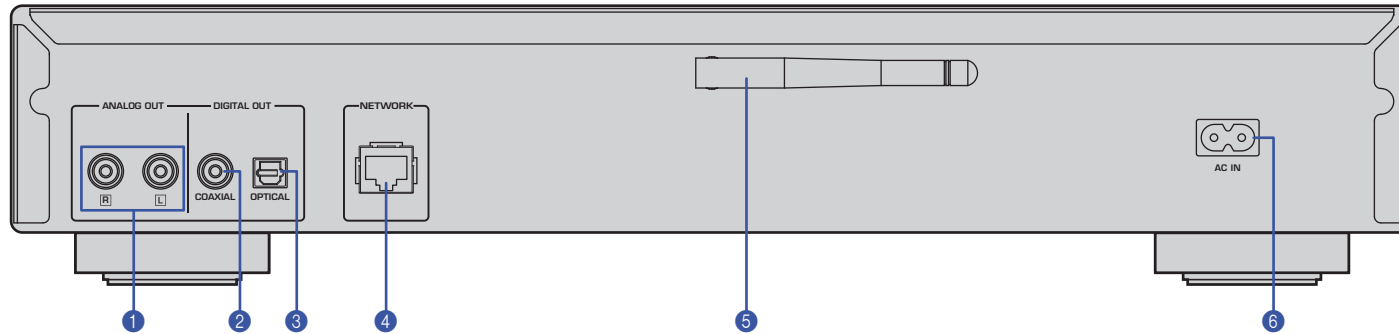

* Illustration above shows Europe model.

1 ANALOG OUT connectors

Output stereo analog audio signals. Connect the unit to your amplifier or audio system using the RCA stereo cable (supplied) (page 17).

2 DIGITAL OUT (COAXIAL) connector

Outputs digital audio signals. Connect the unit to your amplifier or audio system using a coaxial digital audio cable (commercially available) (page 17).

3 DIGITAL OUT (OPTICAL) connector

Outputs digital audio signals. Connect the unit to your amplifier or audio system using an optical digital audio cable (commercially available) (page 17).

4 NETWORK connector

Connect the unit to a network using a LAN cable (commercially available) (page 18).

5 Wireless antenna

Use this antenna to connect the unit to a network wirelessly (Wi-Fi) (page 20). It is also used to enable the *Bluetooth* function (page 36).

6 AC IN connector

Connect the supplied power cord here (page 19).

Remote control

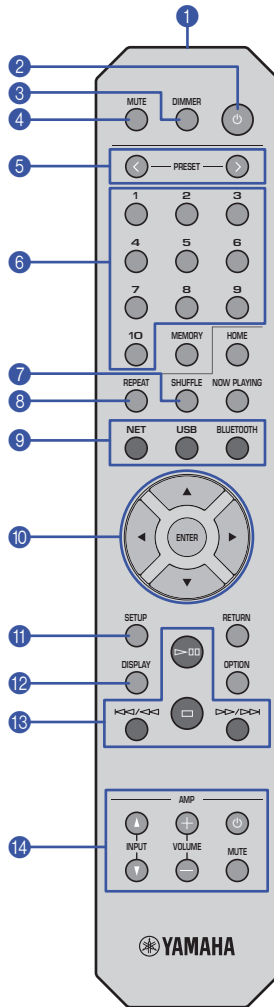

1 Remote control signal transmitter

Transmits infrared signals to the main unit.

2 (power)

Switches this unit between on and standby mode.

3 DIMMER

Enables you to adjust the brightness of the display to 5 levels. Each press of the button changes the brightness.

4 MUTE

Turns mute on or off.

5 PRESET < / >

Recalls a preset song from your PC or USB device, or tunes in to a preset Internet radio station (page 39).

6 Preset number keys

Enable you to enter a number to register or recall a preset (page 38, 39).

7 SHUFFLE

Changes the shuffle settings.

8 REPEAT

Changes the repeat settings.

9 Source select keys

Select the source to which you want.

NOTE

- Pressing NET (network sources) repeatedly selects a different network source each time.

10 ▲ / ▼ / ◀ / ▶ (cursor keys), ENTER

Use the cursor keys to select an item, and then press ENTER to confirm the selection.

11 SETUP

Display the Setup menu (page 41).

12 DISPLAY

Switches information shown on the display, such as playback information (page 38).

13 Playback control keys

▶▶ (Play/Pause)

Starts or pauses playback.

□ (Stop)

Stops playback.

◀◀ / ◀◀ (Skip backward/Search backward)

Skips back to the top of the currently-playing song or the top of the previous song. It also searches tracks backward if the button is pressed and held during playback.

▶▶ / ▶▶ (Skip forward/Search forward)

Skips forward to the top of the next song. It also searches tracks forward if the button is pressed and held during playback.

14 Amplifier control keys

Controls a Yamaha amplifier.

For details on using the amplifier, refer to the manual supplied with the amplifier.

(power)

Turns the amplifier on or off.

INPUT (▲ / ▼)

Switches input sources on the amplifier.

VOLUME (+ / -)

Adjusts the amplifier volume.

MUTE

Turns mute on or off on the amplifier.

NOTE

- Certain Yamaha amplifiers might not support these remote control functions.

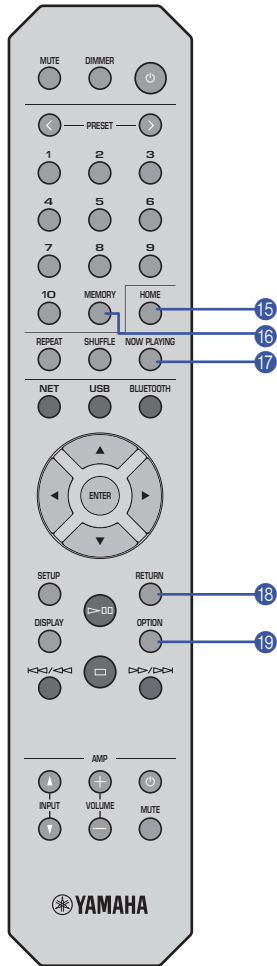

15 HOME

Moves directly to the top level of the menu when you are selecting music files, folders, etc. This can be convenient if you want to navigate the menu levels quickly.

16 MEMORY

Register a song stored on your PC or USB device, or register an Internet radio station as a preset (page 38).

17 NOW PLAYING

Displays the song information while you are selecting or browsing music files, folders, etc.

18 RETURN

Displays the next higher level of the menu.

19 OPTION

Displays audio signal information (page 39). It also enables or disables automatic playback (page 40).

The operating range of the remote control

Point the remote control toward the remote control sensor on the unit from within the range shown in the figure below.

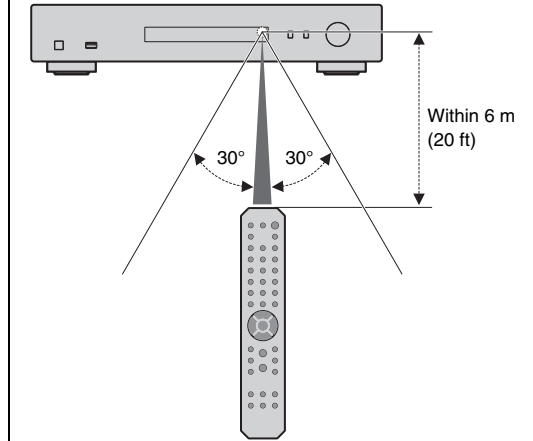

PREPARATION

1 Connecting to an amplifier

⚠ CAUTION

- Do not plug the power cords of this unit and all other connected devices into AC outlets until all connections are complete.

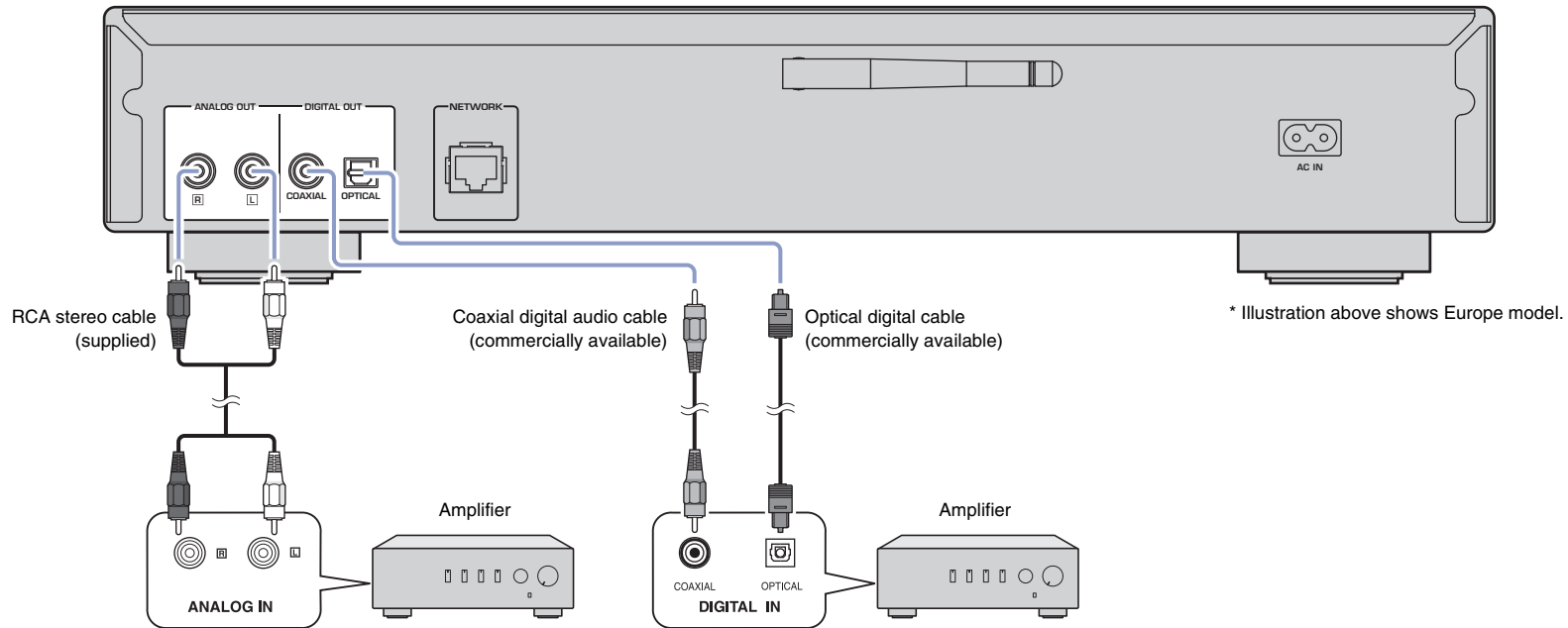

Only PCM signals can be output from the DIGITAL OUT (OPTICAL/COAXIAL) jacks of this unit.

NOTE

- On some audio devices (such as an amplifier) that are digitally connected, audio output might be interrupted at the beginning of a track.
- DSD signals and signals over 192kHz will not be output from the DIGITAL OUT jacks of this unit.
- Digital signals output from this unit cannot be recorded.

2 Preparing to connect to a network

On this unit, you can tune in to an Internet radio station, or play music files that are stored on your PC or a Digital Living Network Alliance (DLNA) server (such as a Network Attached Storage (NAS) device).

Connecting a network cable

To use a wired network, connect the unit to your router with a commercially-available STP network cable (CAT-5 or higher straight cable).

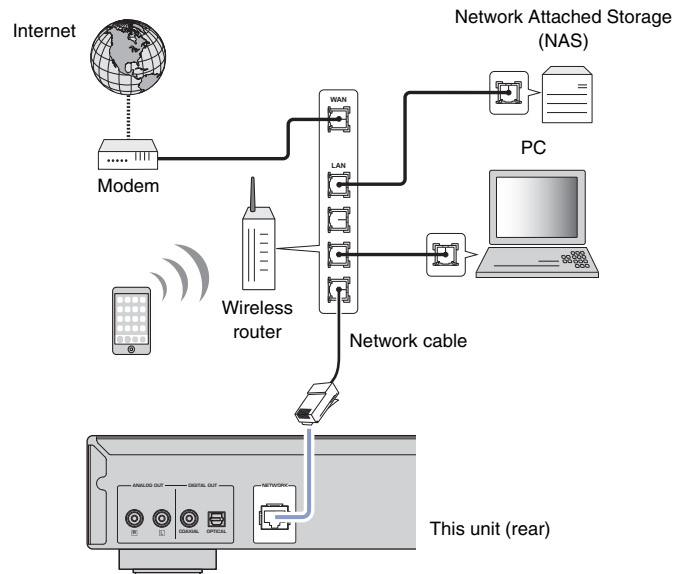

NOTE

- To switch from a wireless network connection to a wired network connection, change “Connection” under “Network” in the Setup menu to “Wired” (page 42).

Preparing a wireless antenna

If you connect the unit to a wireless network and use the *Bluetooth* function, set the wireless antenna in the upright position. For information on how to connect the unit to a wireless network, see “Connecting the unit to the network” (page 20). For information on how to connect the unit to a *Bluetooth* device, see “Listening to music via *Bluetooth*” (page 36).

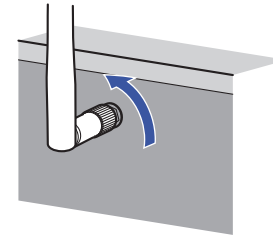

NOTE

- Do not apply excessive force to the wireless antenna. Doing so might damage the antenna.

3 Connecting the power cord

After all the connections are complete, connect the supplied power cord to the AC IN jack on this unit, and then plug into a home AC outlet.

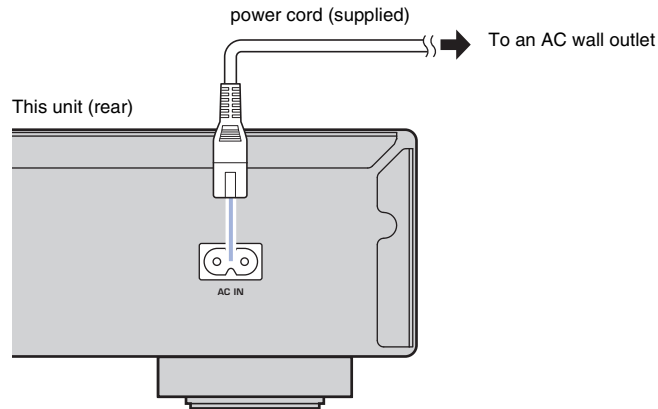

* Illustration above shows Europe model.

4 Turning on the power to the unit

To turn on the power to the unit, press  (power) on the front panel.

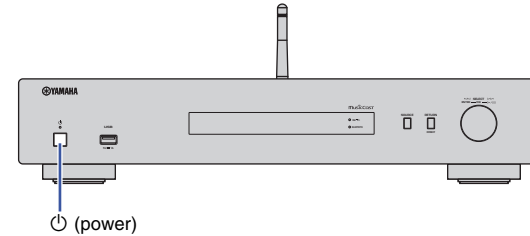

Turning on the power to the unit for the first time

When you turn on the power to the unit for the first time after you purchase or initialize it, the unit will indicate "WAC" on the display, and share the network settings of the iOS device (iPhone) to connect to a wireless network (unless the unit is already connected to a wired network).

If you use this function, proceed to Step 7 in "Sharing the iOS device setting" (page 22). If you connect the unit to a wireless network using another method, press RETURN and proceed to the next page.

WAC (Wireless Accessory Configuration)



5 Connecting the unit to the network

Select a connection method that is suitable for your environment.

This section describes how to use the MusicCast CONTROLLER app to connect the unit to a wireless network.

If you want to connect the unit to a wireless network without using MusicCast CONTROLLER, refer to page 22 for more information. To use MusicCast CONTROLLER while the unit is connected to a network by cable, perform Steps 1 through 4 in the section “Connecting to a network using MusicCast CONTROLLER”.

The following functions are available only if you use the MusicCast CONTROLLER app.

- Playback music from music streaming services.
- Sending signals via *Bluetooth* (page 36)

NOTE

- If you want to play high-resolution audio sources via the network, a wired connection is recommended for more stable playback (page 18).
- Your mobile device must already be connected to the wireless LAN router (access point).
- To manually connect the unit to a network wirelessly, have the SSID and security key for the wireless router (access point) ready.

Connecting to a network by using MusicCast CONTROLLER

This section explains how to register the unit with MusicCast and set up the unit for the network connection.

1 Install MusicCast CONTROLLER.

Download and install the MusicCast CONTROLLER app (free) to your mobile device from the App Store or Google Play.

2 Start the MusicCast CONTROLLER app on your mobile device, and then tap “Setup”.

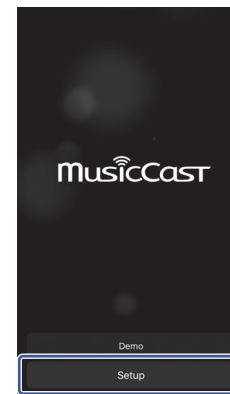

3 Follow the instructions on the display of the mobile device to operate MusicCast CONTROLLER, and then press and hold down the CONNECT on the front panel of the unit for 5 seconds.

“CONNECT” appears on the display and the WiFi indicator blinks.

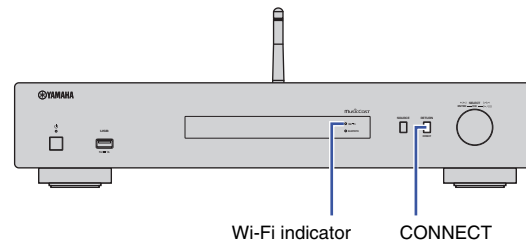

4 Follow the instructions on the display of the mobile device to operate MusicCast CONTROLLER to make the network settings.

Now the unit is registered with MusicCast and the network settings are complete.

Use MusicCast CONTROLLER to play the music.

NOTE

- To set up additional MusicCast-compatible devices, tap the icon ⚙️ (Settings) in the upper-right corner of the MusicCast CONTROLLER screen, and then select “Add New Device”.

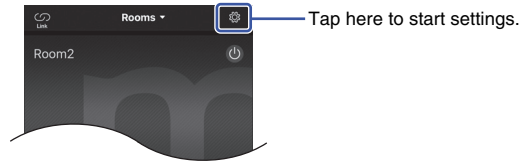

- If you make a “wired” connection between a MusicCast-compatible device and the router, you can expand the reception range (Extend mode). Extend mode will automatically engage in if you install a MusicCast-compatible device in a location where the reception from the router is poor.

Normal mode

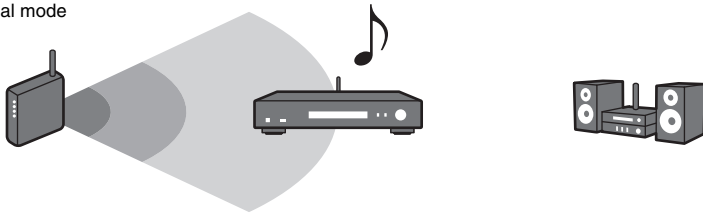

Extend mode

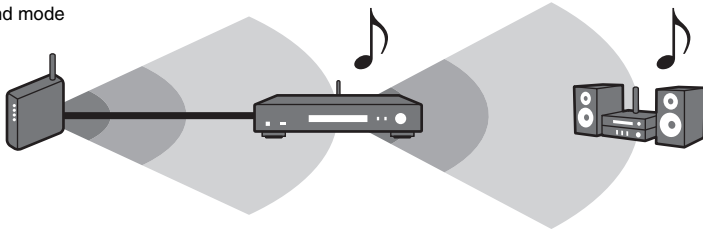

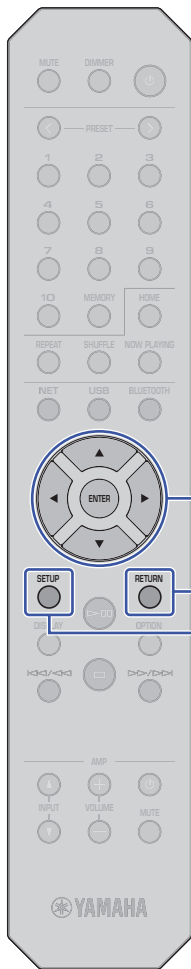

Connecting to a network using another method

You can connect the unit to a wireless network without using MusicCast CONTROLLER.

Select a connection method that is suitable for your environment.

- Sharing the iOS device setting (page 22)
- Using the WPS push button on the router (page 24)
- Manual setup (page 25)

Sharing the iOS device setting

You can easily setup a wireless connection by applying the connection settings of your iOS device (iPhone) to this unit.

Before proceeding, confirm that your iOS device is connected to a wireless LAN router (access point).

NOTE

- Performing the following procedure will initialize all network settings.
- This configuration does not work if the encryption method of your wireless router (access point) is WEP. In this case, use another connection method.

- 1 Press **SETUP**.
- 2 Use the cursor keys (▲/▼) to select “Network”, and then press **ENTER**.

NOTE

- To return to the previous screen, press **RETURN**.

- 3 Use the cursor keys (▲/▼) to select “Connection”, and then press **ENTER**.
- 4 Use the cursor keys (▲/▼) to select “Wireless”, and then press **ENTER**.

- 5 Use the cursor keys (▲/▼) to select “Share Setting”, and then press **ENTER**.

- 6 Press **ENTER**.

The connection process starts. “Connecting” appears on the display.

NOTE

- If the unit is connected to the network by a cable, “LAN CBL Pls disconnect” will appear on the display. Disconnect the network cable from the unit, and then press **ENTER**.

- 7 In the Wi-Fi screen of your iOS device, select this unit as the AirPlay speaker.

E.g., (iOS 10)

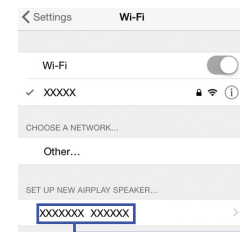

This unit's name

8 Make sure that the “Network” field is set to your preferred network, and then tap “Next”.

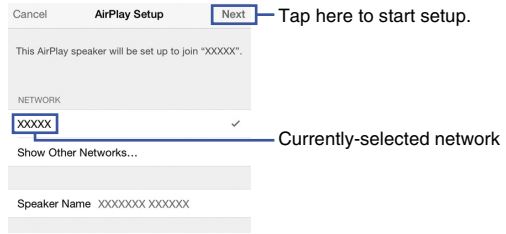

When the setup is complete, the unit will automatically connect to the selected network (access point).

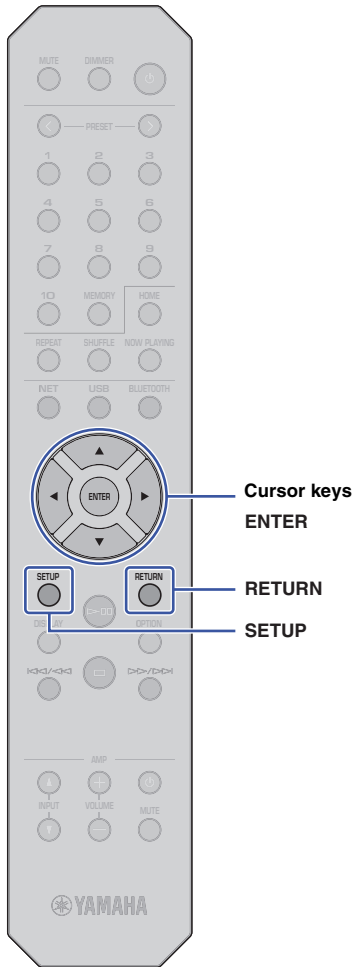

Using the WPS push button on the router

You can use the WPS button on the wireless LAN router (access point) to begin setting up a wireless connection.

NOTE

- This configuration does not work if the encryption method of your wireless LAN router (access point) is WEP or WPA2-TKIP. In this case, use another connection method.

- 1 Press **SETUP**.
- 2 Use the cursor keys (▲/▼) to select “Network”, and then press **ENTER**.

NOTE

- To return to the previous screen, press **RETURN**.

- 3 Use the cursor keys (▲/▼) to select “Connection”, and then press **ENTER**.
- 4 Use the cursor keys (▲/▼) to select “Wireless”, and then press **ENTER**.



- 5 Use the cursor keys (▲/▼) to select “WPS”, and then press **ENTER**.
- 6 Press **ENTER**.
The connection process starts. “Connecting” appears on the display.
- 7 Push the **WPS** button on the wireless LAN router (access point).

When the connection process is complete, “Completed” appears on the display.

If “Not connected” appears, repeat this procedure from step 1 or try another connection method.

- 8 Press **SETUP** to complete the setting.

About WPS

WPS (Wi-Fi Protected Setup) is a network security standard created by the Wi-Fi Alliance. WPS lets home users set up a wireless network easily.

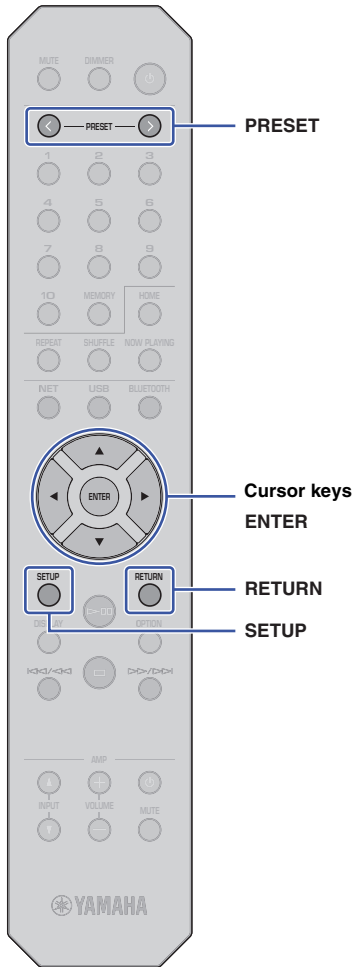

Manual setup

You can connect this unit to a wireless network manually. Before performing the following procedure, verify the encryption method and security key for the wireless LAN router (access point).

- 1 Press **SETUP**.
- 2 Use the cursor keys (**▲/▼**) to select “Network”, and then press **ENTER**.

NOTE

- To return to the previous screen, press **RETURN**.

- 3 Use the cursor keys (**▲/▼**) to select “Connection”, and then press **ENTER**.
- 4 Use the cursor keys (**▲/▼**) to select “Wireless”, and then press **ENTER**.
- 5 Use the cursor keys (**▲/▼**) to select “ManualSetting”, and then press **ENTER**.



- 6 Use the cursor keys (**▲/▼**) to select “SSID”, and then press **ENTER**.



- 7 Use the cursor keys to enter the SSID for the wireless LAN router (access point), and then press **ENTER**.

Use the cursor keys (**▲/▼**) to select a character. Use the cursor keys (**◀/▶**) to move the edit position.

You can insert or delete a character by pressing **PRESET >** (insert) or **PRESET <** (delete).

- 8 Use the cursor keys (**▲/▼**) to select “Security”, and then press **ENTER**.



- 9 Use the cursor keys (**◀/▶**) to select the desired encryption method, and then press **ENTER**.

Settings

None, WEP, WPA2-PSK (AES), Mixed Mode

NOTE

- If you select “None”, the connection might not be completely secure since communications will not be encrypted.

- 10 Use the cursor keys (**▲/▼**) to select “Security Key”, and then press **ENTER**.



- 11 Use the cursor keys to enter the security key for the wireless LAN router (access point), and then press **ENTER**.

If you select “WEP” in Step 9, enter either a 5 or 13-character string; or a 10 or 26-digit hexadecimal number.

If you select “WPA2-PSK (AES)” or “Mixed Mode”, enter either an 8 to 63-character string; or a 64-digit hexadecimal number.

Use the cursor keys (**▲/▼**) to select a character. Use the cursor keys (**◀/▶**) to move the edit position.

You can insert or delete a character by pressing **PRESET >** (insert) or **PRESET <** (delete).

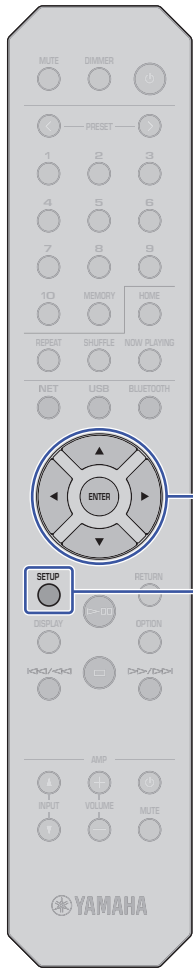

12 Use the cursor keys (▲/▼) to select “Connect [ENT]”, and then press ENTER.

The connection process starts.

If “Not connected” appears, check the SSID and security key for the wireless router (access point) and repeat this procedure from Step 6.

13 Press SETUP to complete the setting.

Cursor keys
ENTER

SETUP

Connecting a mobile device to the unit directly (Wireless Direct)

The Wireless Direct connection enables you to use this unit as a wireless network access point, to which you can connect your mobile devices directly.

NOTE

- Wireless Direct supports the following functions:
 - Operating the unit from a MusicCast CONTROLLER app installed on your mobile device
 - Playing music files via AirPlay
 - Playing music files stored on Android devices using MusicCast CONTROLLER app.

- 1 Press SETUP.**
- 2 Use the cursor keys (▲/▼) to select “Network”, and then press ENTER.**
- 3 Use the cursor keys (▲/▼) to select “Connection”, and then press ENTER.**
- 4 Use the cursor keys (▲/▼) to select “W.Direct”, and then press ENTER.**



- 5 Press ENTER to view the SSID for this unit, and then press RETURN.**

You will need the SSID in Step 11 to configure the Wi-Fi settings for your mobile device.

- 6 Use the cursor keys (▲/▼) to select “Security”, and then press ENTER.**

- 7 Use the cursor keys (◀/▶) to select the desired encryption method, and then press RETURN.**

Settings

None, WPA2-PSK (AES)

NOTE

- If you select “None”, the connection might not be completely secure since communications will not be encrypted.

- 8 Use the cursor keys (▲/▼) to select “Security Key”, and then press ENTER.**



NOTE

- If you select “None” in Step 7, the security key setting will be unavailable. Skip to Step 10.

- 9 Use the cursor keys to enter a security key, and then press ENTER.**

Enter either an 8 to 63-character string or a 64-digit hexadecimal number.

Use the cursor keys (▲/▼) to select a character. Use the cursor keys (◀/▶) to move the edit position.

You can insert or delete a character by pressing PRESET > (insert) or PRESET < (delete).

You will need the security key in Step 11 to configure the Wi-Fi settings for your mobile device.

- 10 Use the cursor keys (▲/▼) to select “Connect [ENT]”, and then press ENTER.**

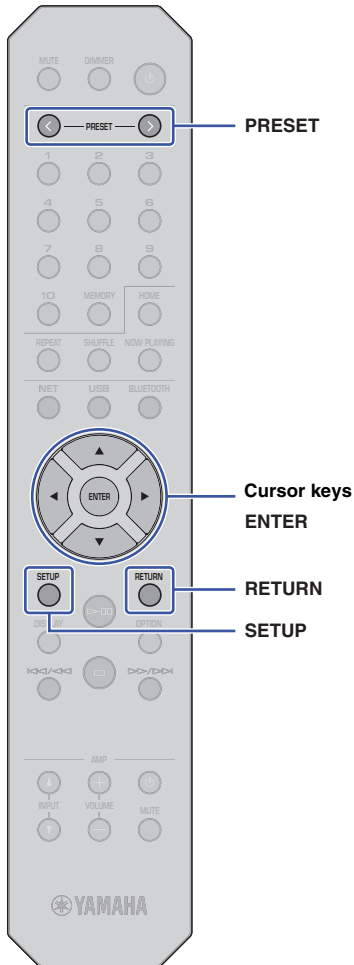

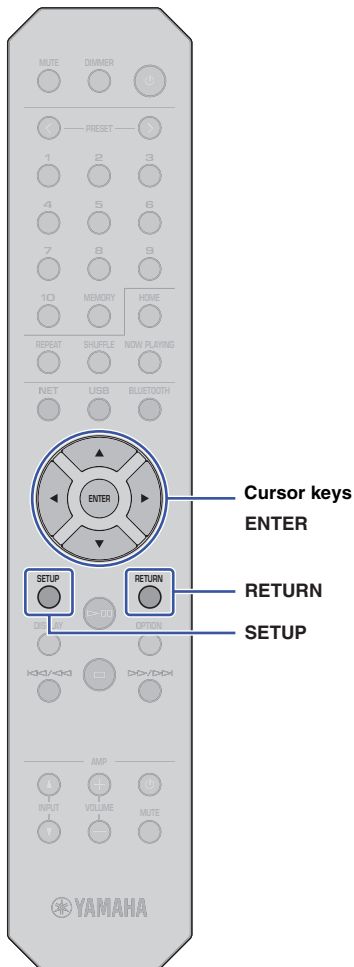

11 Configure the Wi-Fi settings for your mobile device.

For more information, refer to the instruction manual for the mobile device.

- ① Enable the Wi-Fi function on the mobile device.
- ② Select the unit's SSID (that you viewed in Step 5) from the list of available access points.
- ③ When you are prompted to enter a password, enter the security key that you set in Step 9.

If "Not connected" appears, the entered security key may have been incorrect. Set the Wi-Fi function on the mobile device again.

12 Press SETUP to complete the setting.

Verifying the network connection status

Perform the following procedure to verify that the unit is connected to the network (unless it is connected via Wireless Direct).

1 Press SETUP.

2 Use the cursor keys (▲/▼) to select "Network", and then press ENTER.

NOTE

- To return to the previous screen, press RETURN.

3 Use the cursor keys (▲/▼) to select "Information", and then press ENTER.

4 Use the cursor keys (▲/▼) to select "STATUS".



If "Connect" appears, the unit has been connected to the network. If "Disconnect" appears, establish the connection again.

5 Press SETUP to complete the setting.

PLAYING AUDIO

Listening to Internet radio

This unit enables you to listen to Internet radio stations.

NOTE

- To use this function, the unit must be connected to the Internet. You can verify whether the network parameters (such as the IP address) are properly assigned to the unit under “Network” (page 42) in the Setup menu.
- Certain Internet radio stations might not be available at all times or during certain hours.
- This function uses the “airable.Radio” service. This service is provided by Tune In GmbH.
- This service may be discontinued without notice.

Selecting an Internet radio station

Follow the procedure below to select an Internet radio station and start streaming.



1 Press NET to select “NetRadio” as the source.



2 Use the cursor keys to select content, and then press ENTER.

Once you select an Internet radio station, the content will start to play and the information will appear on the display.

Use the following remote control keys to operate the Internet radio streaming service.

Available keys	Function
Cursor keys	Enable you to select an Internet radio station or a category such as a genre of music.
ENTER	Starts playing the broadcast if pressed while an Internet radio station is selected. Selects the next lower level of the menu if pressed while a category is selected.
RETURN	Selects the next higher level of the menu.
Playback control keys	 Starts playing the broadcast.
	 Stops playing the broadcast.
HOME	Displays the top level of the menu for the category selection.
NOW PLAYING	Displays the information of the current Internet radio broadcast.

NOTE

- You can register the current radio station as a preset (page 38).
- Press DISPLAY repeatedly to switch the type of displayed information (page 38).
- Certain information might be unavailable, depending on the radio station.
- An underscore (_) will be displayed for characters not supported by the unit.

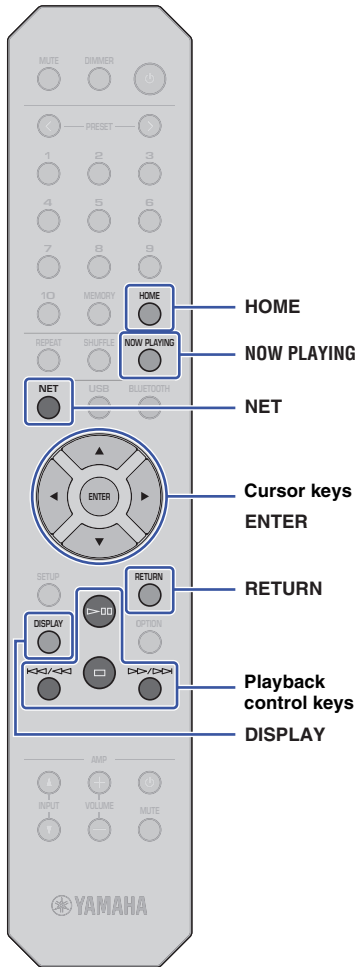

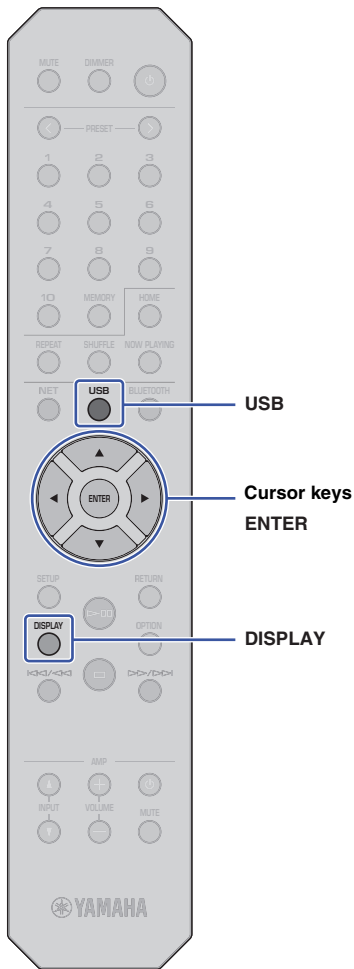

Playing music files stored on your USB device

You can play music files stored on your USB device on the unit.

NOTE

- For information on supported USB storage devices, please refer to “Supported devices and file formats” (page 52).

Connecting a USB storage device

1 Connect the USB storage device to the USB jack.

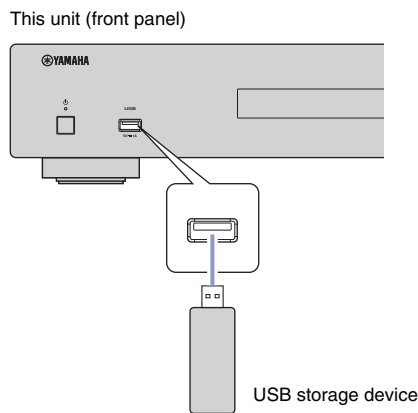

NOTE

- If the USB storage device contains many files, it may take some time to load them. In this case, “Loading...” will appear on the display.
- Stop playback of the USB storage device before you disconnect the device from the USB jack.
- Connect a USB storage device directly to the USB jack of the unit. Do not use extension cables.
- Do not connect your PC to the USB jack.

Playing songs stored on a USB storage device

Follow the procedure below to select a song to play stored on a USB storage device.

NOTE

- An underscore (_) will be displayed for characters not supported by the unit.

1 Press USB to select “USB” as the source.



2 Use the cursor keys to select content, and then press ENTER.

The track begins to play. Related information appears on the display.



NOTE

- You cannot select files in a format that is not supported by the unit.
- Press DISPLAY repeatedly to switch the type of displayed information (page 38).
- You can register the currently-playing song as a preset (page 38).

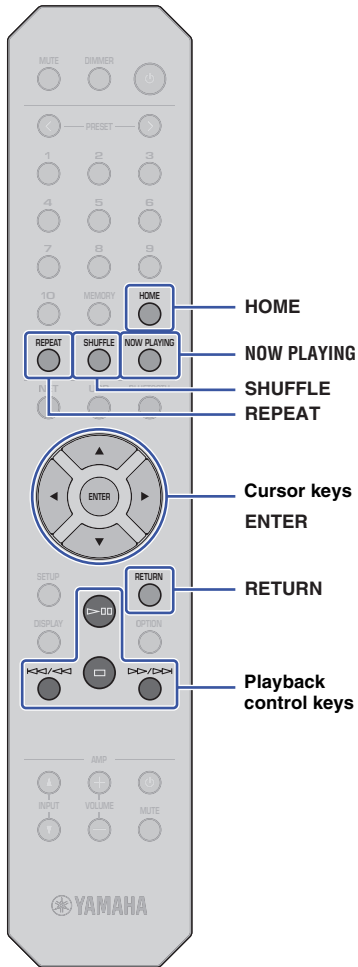

Use the following remote control keys to navigate the menu and to control transport functions.

Available keys	Function
Cursor keys	Select a music file or folder.
ENTER	Starts playing the selected music file. Selects the next lower level of the menu if pressed while a folder is selected.
RETURN	Selects the next higher level of the menu.
Playback control keys	Starts or pauses playback.
	Stops playback.
	Skips back to the top of the currently-playing song (or the previous song if pressed continuously); Skips forward to the next song.
HOME	Displays the root directory of the USB device.
NOW PLAYING	Displays information about the currently-playing song.
REPEAT	Changes the repeat settings. Off: Turns off the repeat function. One: Plays the current song repeatedly. All: Plays all songs in the current album (folder) repeatedly.
SHUFFLE	Changes the shuffle settings. Off: Turns off the shuffle function. On: Plays songs in the current album (folder) in random order.

Playing music files stored on a media server (PC/NAS)

You can play music files stored on your PC or DLNA-compatible Network Attached Storage (NAS) device on the unit.

NOTE

- To use this function, the unit and the PC must be connected to the same router. You can verify whether the network parameters (such as the IP address) are properly assigned to the unit in the “IP” for “Information” under “Network” in the Setup menu (page 42).
- Audio may be interrupted while using a wireless network connection. In this case, use a wired network connection.
- For information on the file format that can be played by the unit, please refer to “Supported devices and file formats” (page 52). Also, please refer to the specifications for the NAS device.

Media sharing setup

To play music stored on the PC (or NAS device) on the unit, you need to enable media sharing between this unit and the other devices.

For a PC that runs Windows Media Player

The setting procedure may vary depending on the PC or the version of Windows Media Player. The following instructions use Windows Media Player12 as an example.

- 1 Start Windows Media Player 12 on your PC.**
- 2 Select “Stream”, then “Turn on media streaming”.**
- 3 Click “Turn on media streaming”.**
- 4 Select “Allowed” from the drop-down list next to the unit’s model name.**
- 5 Click “OK” to exit.**

NOTE

- For details on media sharing settings, refer to the Windows Media Player help.

For a PC or a NAS that runs DLNA server software other than Windows Media Player

Refer to the instruction manual for the device or software and configure the media sharing settings.

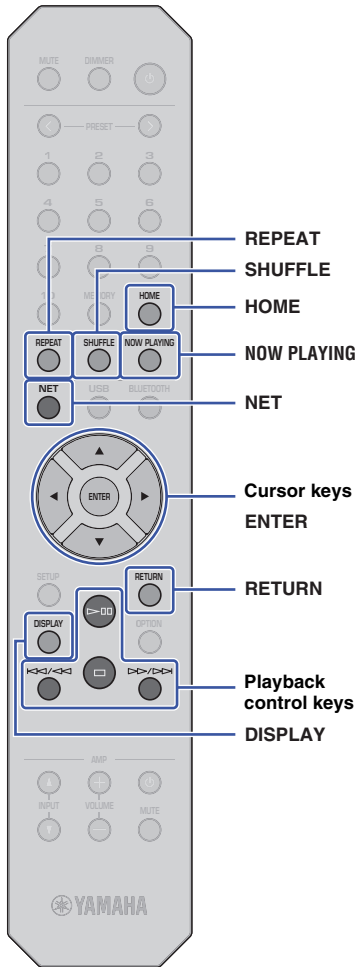

Selecting and playing music stored on a PC (or server)

Follow the procedure below to select a song to play stored on a PC (or server).

NOTE

- An underscore (_) will be displayed for characters not supported by the unit.

1 Press NET repeatedly to select “Server” as the source.



2 Use the cursor keys to select a PC (or server), and then press ENTER.

3 Use the cursor keys to select content, and then press ENTER.

The track begins to play. Related information appears on the display.

NOTE

- If you are playing a music file stored on your PC, the song information will appear on the PC monitor.
- You can register the currently-playing song as a preset (page 38).
- Press DISPLAY repeatedly to switch the type of displayed information (page 38).
- You cannot select files in a format that is not supported by the unit.
- If there are consecutive unplayable files (including image or hidden files), playback will stop automatically.

Use the following remote control keys to control playback and other transport functions.

Available keys	Function
Cursor keys	Select a music file or folder.
ENTER	Starts playing the currently-selected content. Selects the next lower level of the menu if pressed while a folder is selected.
RETURN	Selects the next higher level of the menu.
Playback control keys	Starts or pauses playback.
	Stops playback.
	Skips back to the top of the currently-playing song (or the previous song if pressed continuously); Skips forward to the next song.
HOME	Displays the root directory of the PC (or server).
NOW PLAYING	Displays information about the currently-playing song.
REPEAT	Changes the repeat settings. Off: Turns off the repeat function. One: Plays the current song repeatedly. All: Plays all songs in the current album (folder) repeatedly.
SHUFFLE	Changes the shuffle settings. Off: Turns off the shuffle function. On: Plays songs in the current album (folder) in random order.

NOTE

- You can also use a DLNA-compatible Digital Media Controller (DMC) to control playback. For more information, please refer to “DMC Control” (page 43) in the “Setup” section.

Listening to music via AirPlay

You can use the AirPlay function to play iTunes or iPhone music files via a network.

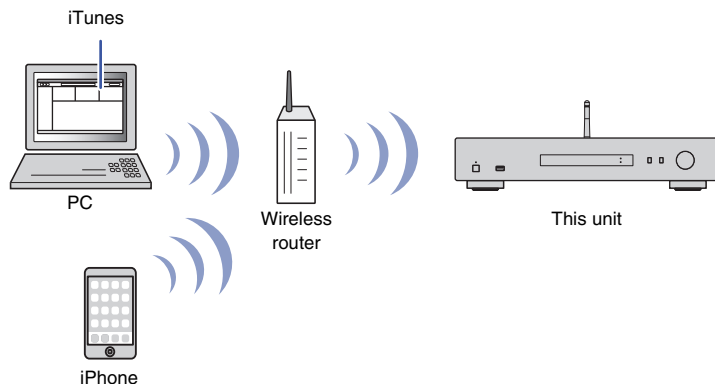

NOTE

- To use this function, the unit and your PC, iPhone must be connected to the same router (page 20). You can verify whether the network parameters (such as the IP address) are properly assigned to the unit under “Network” (page 42) in the Setup menu.
- If the iPhone does not recognize the unit, check your network environment (such as the router) (page 20).
- For information on supported iPhones, please refer to “Supported devices and file formats” (page 52).

Playing a song from iTunes/iPhone

Follow the procedure below to play the music from iTunes or iPhone on the unit.

1 Start iTunes, or display the Music playback screen on the iPhone.

Once the iTunes or iPhone recognizes the unit, the AirPlay icon appears.

iOS 10 (display example)



iTunes (display example)



NOTE

- If the icon does not appear, make sure that the unit and the PC or iPhone are connected to the router properly.

2 On the iTunes or iPhone, click (tap) the AirPlay icon, and then select “NP-S303 XXXXXX” (network name of the unit) as the audio output device.

NOTE

- You can change the network name of the unit by using the “Network Name” parameter under “Network” in the Setup menu (page 43).

3 Select a song in iTunes or on the iPhone to start playback.







The unit automatically selects “AirPlay” as the source, and playback starts.

The playback information is shown on the display.

NOTE

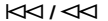
- Press DISPLAY repeatedly to switch the type of displayed information (page 38).
- If “Standby (Network Standby)” (page 43) in the Setup menu is set to “On” or “Auto”, the unit will automatically turn on when playback starts on iTunes or iPhone.
- An underscore (_) will be displayed for characters not supported by the unit.

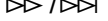
Use the following remote control keys to navigate the menu and transport function.

Available keys	Function
	Starts or pauses playback.
	Stops playback.
 / 	Skips back to the top of the currently-playing song (or the previous song if pressed continuously); Skips forward to the next song.
 / 	Skips forward to the next song.
REPEAT	Changes the repeat settings.
SHUFFLE	Changes the shuffle settings.

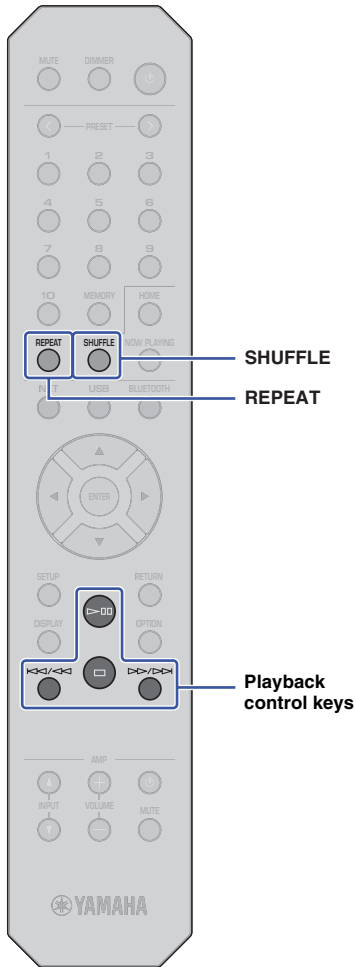

Listening to music via *Bluetooth*

Playing audio from *Bluetooth* devices on the unit

You can play music files stored on a *Bluetooth* device (such as a smartphone) on the unit.

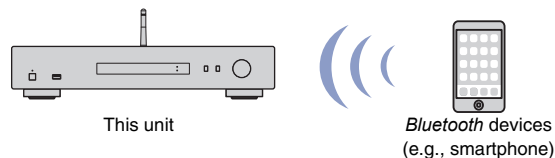

NOTE

- To use the *Bluetooth* function, set “Bluetooth” (page 44) in the Setup menu to “On”.
- If you use the *Bluetooth* function, set the wireless antenna on the rear panel in the upright position (page 18).
- For information on supported *Bluetooth* devices, refer to “Supported devices and file formats” (page 52).

1 Press **BLUETOOTH** to select “Bluetooth” as the source.

2 On the *Bluetooth* device, turn the *Bluetooth* function on.

3 On the *Bluetooth* device, select the unit “NP-S303 XXXXXX Bluetooth” from the available device list.

“Connected” appears on the display and the BLUETOOTH indicator lights up when the unit establishes a connection to the *Bluetooth* device.



NOTE

- If you are prompted to enter a passkey, enter the number “0000”.
- The initial network name of the unit is “NP-S303 XXXXXX”.
- You can change the network name of the unit by using the “Network Name” parameter under “Network” in the Setup menu (page 43).
- If the unit is registered as a MusicCast device, the room name will appear on the available device list.

4 On the *Bluetooth* device, select a song and start playback.

NOTE

- If the unit detects a *Bluetooth* device that was previously connected, the unit will automatically connect to the *Bluetooth* device after you perform Step 1. To establish another *Bluetooth* connection, first terminate the current *Bluetooth* connection.
- To terminate a *Bluetooth* connection, perform one of the following operations:
 - Disconnect from the *Bluetooth* device.
 - Select any option other than “Bluetooth” as the source for this unit.
 - Press and hold down the BLUETOOTH key for three seconds or longer.

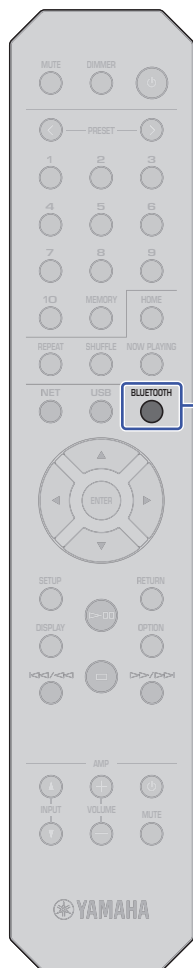

BLUETOOTH

Playing audio from this unit through *Bluetooth*-compatible speakers or headphones

You can listen to audio (that is being played on the unit) through *Bluetooth*-compatible speakers or headphones. To do this, you will use the MusicCast CONTROLLER app (installed on your mobile device) to transmit audio to *Bluetooth*-compatible speakers or headphones.

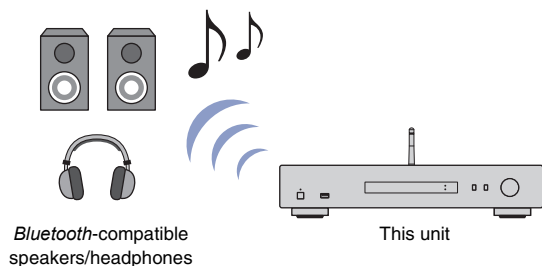

NOTE

- Use *Bluetooth*-compatible speakers or headphones that support the A2DP profile.
- You cannot use both a *Bluetooth* device (such as a smartphone) and *Bluetooth* speakers (or headphones) at the same time.
- AirPlay or DSD audio will not be transferred.
- Examples of the MusicCast CONTROLLER screens are taken from an iPhone.
- Please also refer to the instruction manual for your *Bluetooth* device.

- 1 Use the MusicCast CONTROLLER app to connect the unit to a network, and register the unit with MusicCast (page 20).**
- 2 Use the MusicCast CONTROLLER app to play a song (via any device other than a *Bluetooth* device).**
- 3 Pair *Bluetooth*-compatible speakers (or headphones) and the unit to establish a *Bluetooth* connection.**

- 4 Tap  in the MusicCast CONTROLLER app's playback screen.**



- 5 Tap "Bluetooth Transmission".**



- 6 Enable the *Bluetooth* Transmission function, and then select your *Bluetooth*-compatible speakers (or headphones) as the transmission destination.**

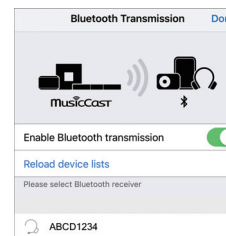

When the connection is established, the unit's Bluetooth indicator will light up, and audio will play from the *Bluetooth*-compatible speakers (or headphones).

- 7 Close the Setup screen.**

NOTE

- To disconnect *Bluetooth*-compatible speakers (or headphones), perform one of the following operations.
 - Disconnect from the *Bluetooth*-compatible speakers or headphones.
 - Disable the MusicCast CONTROLLER app's *Bluetooth* Transmission function.
 - Select "Bluetooth" as the source for this unit.

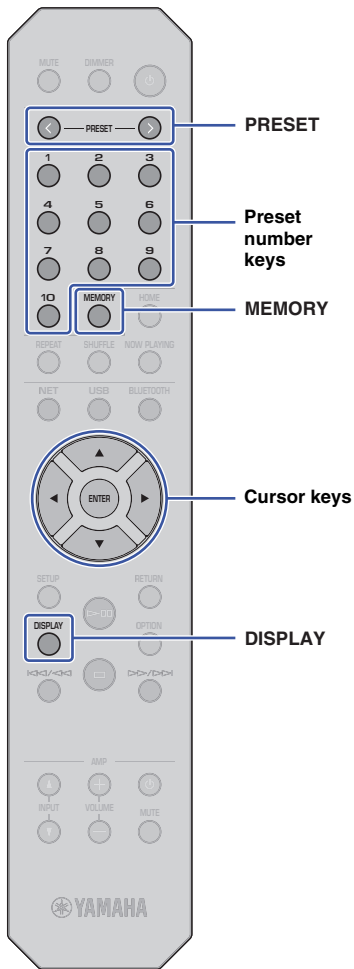

Useful functions

Switching information on the display

You can switch information shown on the display, such as playback information.

1 Press DISPLAY.

Each time you press the key, the displayed item changes.



About 3 seconds later, the information regarding the displayed item appears.



Source	Item
Bluetooth	Track (song title)
	Artist (artist name)
	Album (album name)
Server AirPlay USB	Track (song title)
	Artist (artist name)
	Album (album name)
Net Radio	Time (elapsed time)
	Station (station name)
	Track (song title)
	Album (album name)
	Time (elapsed time)

Registering favorite content (Preset function)

You can register up to 40 favorite content items (songs stored on your PC or USB devices and Internet Radio stations) as presets, and recall them directly by specifying the preset numbers.

NOTE

- You can also register them using MusicCast CONTROLLER (page 12).
- You cannot clear registered presets from this unit. Use MusicCast CONTROLLER to do so.

Registering content

You can select desired content and register it to a preset number.

1 Play a song or an Internet Radio station that you want to register.

NOTE

- By pressing and holding down preset number keys following step 1, you can skip the steps below and automatically register the content.

2 Press and hold down MEMORY for 3 seconds.

To assign content to a preset number, select a preset number using PRESET </> or the cursor keys (◀▶). You can also directly enter the preset number using the preset number keys.



Preset number

"Empty" (not in use) or the content name that is currently registered

NOTE

- To cancel the registration, press RETURN.

3 Press MEMORY to confirm the registration.

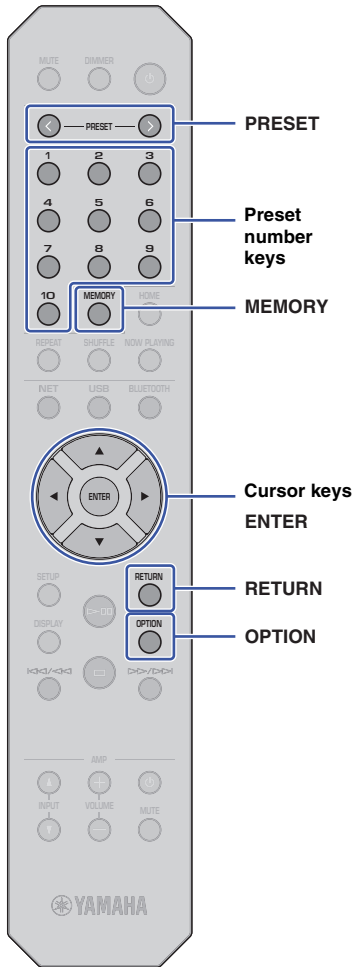

Recalling a preset content

You can select an audio file from the registered preset numbers.

- 1 Press PRESET </> or the preset number keys to specify the preset number to select the content to which you want to listen.**

A few seconds after you select the preset number, playback will start.

NOTE

- You can recall preset numbers 1 through 10 by using preset number keys.
- “No Presets” will appear if no items are registered.
- In the following cases, the selected preset item will not play.
 - The connected USB storage device does not contain the registered audio file.
 - A PC that stores the registered item is turned off or is not connected to the network.
 - An Internet Radio station (that is registered as a preset) is temporarily off air or out of service.
 - The registered item (file) has been deleted or moved to another location.
- When you register a music file (stored on a USB storage device or a PC), the unit memorizes the relative position of the music file in the folder. Therefore, if you add or delete music files to or from the folder, the unit may be unable to recall the preset music file correctly. In such cases, register the item again.
- To cancel the recall operation, press RETURN.
- Even if the unit is in Standby mode, pressing a preset number key will turn on the power to the unit and recall the corresponding preset content.

Displaying audio signal information

You can view information about the signal from the currently-playing audio source.

- 1 Press OPTION.**
- 2 Use the cursor keys (▲/▼) to select “Signal Info.”, and then press ENTER.**

NOTE

- To return to the previous screen during menu operations, press RETURN.

- 3 Use the cursor keys (▲/▼) to switch the display of the audio signal information.**

FORMAT	Audio format
SAMPLING	Number of samples per second

- 4 Press OPTION to complete the setting.**

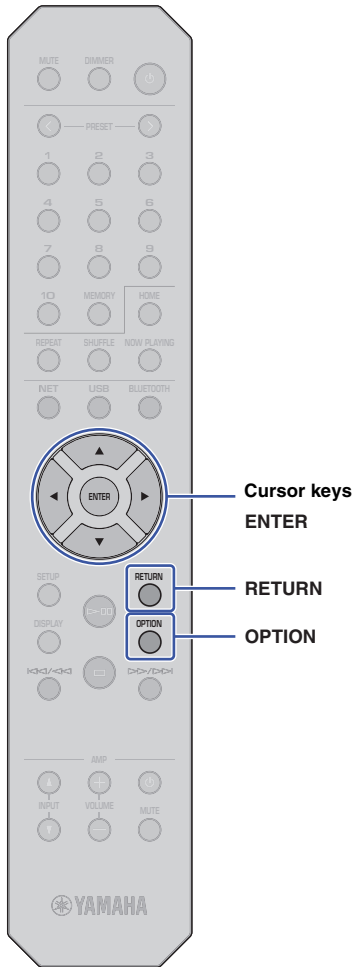

Enabling/disabling automatic playback

You can enable (or disable) the automatic playback function so that playback will (or will not) automatically start immediately after the power is turned on or the source is changed. (This function is effective only when the source is “Server” or “USB”.)

- 1 Press **OPTION**.
- 2 Use the cursor keys (**▲/▼**) to select “Auto Playback”, and then press **ENTER**.

NOTE

- To return to the previous screen during menu operations, press **RETURN**.

- 3 Use the cursor keys (**◀/▶**) to switch between enabling and disabling the automatic playback function.

Off	Disables the automatic playback function.
On (default)	Enables the automatic playback function. If the unit keeps a history of playback, the last item that was played will be played again. If such an item no longer exists, the unit will not play it.

- 4 Press **OPTION** to complete the setting.

Setup

Configuring various functions (Setup menu)

This section explains how to configure various functions.

1 Press **SETUP**.



2 Use the cursor keys (▲/▼) to select a menu, and then press **ENTER**.

3 Use the cursor keys (▲/▼) to select a menu option, and then press **ENTER**.

NOTE

- To return to the previous screen during menu operations, press **RETURN**.

4 Use the cursor keys (◀/▶) to select a value, and then press **ENTER**.

5 Press **SETUP** to complete the setting.

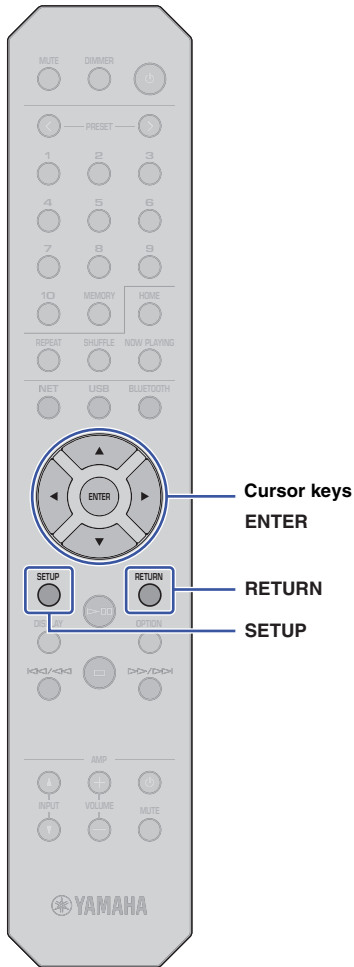

Setup menu items

Menu	Menu options	Function	Page
	Connection	Enables you to select a network connection method.	42
	Information	Displays the unit's network information.	42
	IP Address	Enables you to configure the network parameters (such as IP address).	42
Network	DMC Control	Enables or disables DLNA-compatible Digital Media Controllers (DMC) to control playback.	43
	Standby (Network Standby)	Enables or disables the function that turns on the power to the unit from other network devices.	43
	Network Name	Enables you to edit the unit's name as displayed on other network devices.	43
	Update (Network Update)	Updates the firmware via the network.	43
	On/Off	Enables or disables the <i>Bluetooth</i> function.	44
Bluetooth	Standby (Bluetooth Standby)	Enables or disables the function that turns on the unit from <i>Bluetooth</i> devices.	44
	AutoPowerStby (Auto Power Standby)	Enables or disables the Auto-Standby function. When this function is enabled, if you do not operate the unit or play any file for the specified time, the unit will automatically enter standby mode.	44

Network

The Network menu enables you to configure network parameters.

Connection

Enables you to select a network connection method.

Wired	Select this option if you connect the unit to a network using a commercially-available network cable (Page 18).
Wireless	Select this option if you connect the unit to a network via a wireless LAN router (access point) (Page 22).
W.Direct	Select this option if you connect your mobile device directly to the unit. For more information, refer to “Connecting a mobile device to the unit directly (Wireless Direct)” (page 27).

NOTE

- If other MusicCast-compatible devices are connected in Extend mode, “Extend(1)” or “Extend(2)” will appear. For more information on the Extend mode, refer to page 21.

Information

Displays the unit's network information.

NEW FW	Indicates whether an update for this unit's firmware is available (Page 46).
STATUS	Displays the network connection status of the unit (except for Wireless Direct connection).
MC NET	Displays the status of the MusicCast Network. If “Ready” appears, you can use the MusicCast CONTROLLER app.
MAC	Displays the unit's MAC address. MAC address varies depending on the connection method (wired LAN connection or wireless LAN/Wireless Direct connection).
SSID	Displays the unit's SSID (only for wireless LAN or Wireless Direct connection).
IP	Displays the unit's IP address.
SUBNET	Displays the subnet mask
GATEWAY	Displays the IP address of the default gateway.
DNS P	Displays the IP address of the primary DNS server.
DNS S	Displays the IP address of the secondary DNS server.

IP Address

Enables you to configure the network parameters (such as IP address).

DHCP

This parameter specifies whether a DHCP server will be used.

Off	A DHCP server will not be used. You must configure network parameters manually. For details, see “Configuring the network parameters manually” below.
On (default)	A DHCP server will be used, and it will automatically obtain the unit's network parameters (such as IP address).

Configuring the network parameters manually

- 1 Select “DHCP”.
- 2 Use the cursor keys (◀/▶) to select “Off”, and then use the cursor keys (▲/▼) to select a parameter to configure.

IP	Specifies the IP address.
SUBNET	Specifies the subnet mask.
GATEWAY	Specifies the IP address of the default gateway.
DNS P	Specifies the IP address of the primary DNS server.
DNS S	Specifies the IP address of the secondary DNS server.

- 3 Use the cursor keys (◀/▶) to select the edit position.



(Example: IP address setting)

Use the cursor keys (◀/▶) to select a segment to edit.

- 4 Use the Cursor keys (▲/▼) to change the value.
- 5 Press SETUP to complete the setting.

DMC Control

Enables or disables DLNA-compatible Digital Media Controllers (DMC) to control playback.

Disable	Disables DMCs to control playback.
Enable (default)	Enables DMCs to control playback.

NOTE

- A Digital Media Controller (DMC) is a device that enables you to control other network devices through the network. When this function is turned on, you can control playback of the unit from a DMC, such as Windows Media Player 12 (that is on the same network as this unit).

Standby (Network Standby)

Enables or disables the function that turns on the power to the unit from other network devices.

Off	Disables the Network Standby function.
On	Enables the Network Standby function. This setting will consume more power than the "Off" setting.
Auto (default)	Enables the Network Standby function. If the unit is not connected to a network, the function will be turned off automatically.



With an advanced energy saving design, this product achieves a low power consumption of not more than 2 watts when in Network Standby mode.

Network Name

Enables you to edit the the unit's name as displayed on other network devices.

1 Select "Network Name".



2 Press ENTER to display the edit screen.



3 Use the cursor keys (◀▶) to select the edit position, and then use the cursor keys (▲▼) to change the character.

You can insert or delete a character by pressing PRESET > (insert) or PRESET < (delete).

4 Press ENTER to confirm the new name.

5 Press SETUP to complete the setting.

Update (Network Update)

Updates the firmware via the network.

PerformUpdate	Executes firmware update. For more information, refer to "Updating the unit's firmware via the network" (page 46).
Version	Displays the current firmware version.
ID	Displays the unit's system ID number.

Bluetooth

This menu enables you to configure the *Bluetooth* settings of the unit.

On/Off

Enables or disables the *Bluetooth* function.

Off	Disables the <i>Bluetooth</i> function.
On (default)	Enables the <i>Bluetooth</i> function. Immediately after selecting “On”, the audio output from the network will pause momentarily.

Standby (*Bluetooth Standby*)

Enables or disables the function that turns on the power to the unit from *Bluetooth* devices. If this function is set to “On”, the unit will automatically turn on when you operate a *Bluetooth*-connected device.

Off	Disables the <i>Bluetooth Standby</i> function.
On (default)	Enables the <i>Bluetooth Standby</i> function.

NOTE

- This setting is not available when “Standby (Network Standby)” (page 43) is set to “Off”.

AutoPowerStby (Auto Power Standby)

This menu setting enables or disables the Auto Power Standby function. If you select “On”, the unit will automatically enter standby mode if you do not operate the unit or play any file for the specified time.

Off	Disables the Auto Power Standby function.
On	Enables the Auto Power Standby function. The unit will automatically enter standby mode if you do not play audio or operate the unit for 20 minutes. Also, the unit (with any source selected) will automatically enter standby mode if you leave it unoperated for 8 hours.

Default

U.K. and Europe models: On

Other models: Off

NOTE

- Immediately before the unit automatically enters standby mode, “AutoPowerStby” will appear on the display along with the number of seconds it takes until standby mode kicks in.

Configuring the system settings (Advanced Setup menu)

You can change the system settings from the front panel.

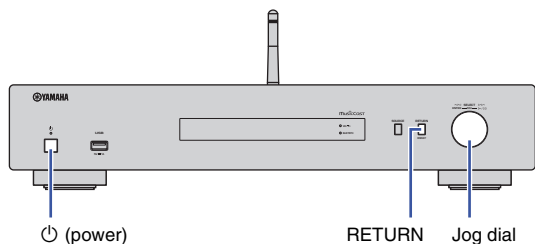

- 1 If the power to the unit is on, press **power** to turn the power off.
- 2 While pressing and holding down **RETURN**, press **power**.
- 3 Rotate the jog dial to select a parameter to change.
- 4 Press the jog dial to select the value.
- 5 Press **power** to turn off the power to the unit. Then turn it on again.

The new settings take effect.

Viewing the firmware version (VERSION)

You can view the version of the firmware currently installed on the unit.

NOTE

- You can also view the firmware version under “Update (Network Update)” (page 43) in the Setup menu.
- It may take a while until the firmware version is displayed.

Initializing the unit (INIT)

You can initialize the unit to restore the default settings.

Settings

CANCEL (default)	Does not initialize the unit.
NETWORK	Initializes all network, Bluetooth, and USB settings. Initialization will also clear all presets for the network and USB devices (page 38).
All	Initializes all settings on the unit.

Updating the firmware (UPDATE)

You can update the firmware on the unit.

New firmware that provides additional features or product improvements is released as needed. Do not perform this procedure unless firmware update is necessary. Also, make sure you read the information supplied with the updates.

Settings

USB	Updates the firmware using a USB storage device.
NETWORK	Updates the firmware via the network. (The unit must be connected to the Internet.)

Updating the firmware

- 1 Press the jog dial on the front panel repeatedly to select “USB” or “NETWORK”, and then press **SOURCE** on the front panel to start firmware update.

NOTE

- Alternatively, you can follow the steps in “Updating the unit’s firmware via the network” (page 46) to update the firmware.

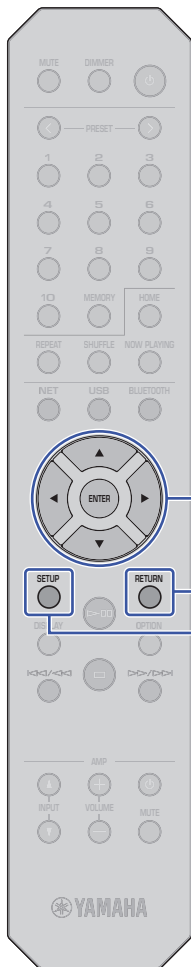

Updating the unit's firmware via the network

New firmware that provides additional features or product improvements is released as needed. If the unit is connected to the Internet, you can download the latest firmware via the network and update it. For details on how to update, visit the Yamaha website.

NOTICE

- Firmware update takes about 5 minutes or longer (depending on your Internet connection speed). Do not operate the unit or disconnect the power cord or network cable during firmware update.

NOTE

- A firmware update may fail due to insufficient Internet speed or other issues related to wireless network connections. In this case, try to update the firmware later, or update it using the USB storage device (page 45).

- Press **SETUP**.
- Use the cursor keys (**▲/▼**) to select "Network", and then press **ENTER**.
- Use the cursor keys (**▲/▼**) to select "Information", and then press **ENTER**.

If new firmware is available, "NEW FW Available" will appear on the front display.



- Press **RETURN** to return to the previous screen.
- Use the cursor keys (**▲/▼**) to select "Update", and then press **ENTER**.



NOTE

- To cancel the firmware update operation, press **SETUP** to exit the Setup menu.

- Press **ENTER**.

The firmware update starts.

- When "UPDATE SUCCESS" appears on the display, press **⏻** (power) on the front panel to turn off the power to the unit.

The firmware update is complete.

Notice of new firmware available

If new firmware is available, "NEW FW Available" will appear on the display for a short while when you turn on the power to the unit.



To start the firmware update, press **ENTER** while this notice is displayed. When "UPDATE PerformUpdate" appears on the display, press **ENTER**. When "UPDATE SUCCESS" appears on the display, press **⏻** (power) on the front panel to turn off the power to the unit.

APPENDIX

Troubleshooting

Refer to the table below if the unit fails to function properly.

If your problem is not listed below, or if the symptoms persist after you follow the instructions below, turn off the power to the unit by pressing \odot (power) on the front panel, disconnect the power cord, and contact your nearest authorized Yamaha dealer or service center.

General

Problem	Cause	Solution	Page
The power does not turn on.	The protection circuitry has been activated three times consecutively. If you try to turn on the power to the unit under this condition, the power indicator on the front panel will blink.	As a safety precaution, capability to turn on the power has been disabled. Contact your nearest Yamaha dealer or service center to request repair.	—
	The power cord is not connected or the plug is not completely inserted.	Connect the power cord firmly.	19
	The internal microcomputer has frozen, due to an external electrical shock (such as lightning or excessive static electricity) or due to a drop in the power supply voltage.	Disconnect the power cord from the AC wall outlet, wait 15 seconds or longer, and then plug in the cable again.	—
Pressing the \odot (power) on the remote control does not turn on the power to the unit.	The unit is turned off.	If the power to the unit is turned off, pressing the \odot (power) on the remote control will not turn on the unit. To turn on the power to the unit, press \odot (power) on the front panel.	19
The unit does not turn off or enter standby mode.	The internal microcomputer has frozen, due to an external electrical shock (such as lightning or excessive static electricity) or due to a drop in the power supply voltage.	Disconnect the power cord from the AC wall outlet, wait 15 seconds or longer, and then plug in the cable again.	—
No sound.	The cable is not properly connected to the unit or the amplifier.	Connect the cables properly. If the problem persists, the cables may be defective. Replace the cables.	17
	The unit or amplifier is muted.	Press MUTE to turn mute off on the unit or amplifier.	15
The sound suddenly goes off.	The Auto Power Standby function has turned off the power to the unit.	Set the Auto Power Standby function ("AutoPowerStby" in the Setup menu) to "Off".	44
	The protection circuit has kicked in.	As a safety precaution, the protection circuit has been engaged. Turn on the power to the unit again.	—
The remote control does not work or function properly.	Wrong distance or angle.	Use the remote control within the operative range.	16
	Direct sunlight or lighting (from an inverter type of fluorescent lamp, etc.) is striking the remote control sensor of this unit.	Reposition the orientation of the lighting or the unit.	—
	The batteries are weak.	Replace all batteries.	10

Bluetooth

Problem	Cause	Solution	Page
Unable to pair the unit with the <i>Bluetooth</i> device.	The <i>Bluetooth</i> function on the unit is disabled.	Set "Bluetooth" in the Setup menu to "On".	44
	Another <i>Bluetooth</i> device is already connected to this unit.	Disconnect the <i>Bluetooth</i> device that is currently paired, and then pair with the desired <i>Bluetooth</i> device.	36
	The unit and the <i>Bluetooth</i> devices are too far apart.	Move the <i>Bluetooth</i> device closer to the unit.	—
	A device emitting electromagnetic waves (such as a microwave oven, a wireless device and so on) may be located nearby.	Use this unit further away from any devices that emit electromagnetic waves.	—
	Your <i>Bluetooth</i> device does not support the A2DP protocol.	Use a <i>Bluetooth</i> device that supports the A2DP protocol.	—
	The connection profile registered in the <i>Bluetooth</i> device may not be functioning correctly for some reason.	Delete the <i>Bluetooth</i> profile in the <i>Bluetooth</i> device, and then connect the <i>Bluetooth</i> device to this unit.	—
	The passkey of the devices, such as a <i>Bluetooth</i> adaptor, that you want to pair with the unit is other than "0000".	Use a connecting device with a passkey "0000".	—
No sound can be heard, or the sound cuts off intermittently.	The volume level of the <i>Bluetooth</i> device is too low.	Increase the volume level of the <i>Bluetooth</i> device.	—
	The <i>Bluetooth</i> device is not set to send audio signals to this unit.	On the <i>Bluetooth</i> device, select this unit as the audio output destination.	36
	The <i>Bluetooth</i> connection has been cut.	Perform <i>Bluetooth</i> connection operations again.	36
	The unit and the <i>Bluetooth</i> devices are too far apart.	Move the <i>Bluetooth</i> device closer to the unit.	—
	A device emitting electromagnetic waves (such as a microwave oven, a wireless device and so on) may be located nearby.	Use this unit further away from any devices that emit electromagnetic waves.	—

USB/Network

Problem	Cause	Solution	Page
The unit does not recognize the USB device.	The USB device may not be properly connected to the USB jack.	Turn off the power on this unit, and reconnect the USB device.	30
	You may be using a USB device that is not formatted as FAT16/32.	Be sure to use a USB device formatted as FAT16/32.	52
The folders and files on the USB device are not displayed.	The data on the USB device may have been encrypted.	Be sure to use a USB device that has not been encrypted.	52
Unable to use the network function.	The network parameters (IP address) have not been obtained properly.	Enable the DHCP server function on the router. Set "DHCP" in the Setup menu to "On". If you are manually setting network parameters without using a DHCP server, make sure that the unit will have a unique IP address that does not match the IP address of other devices on the network.	42
The unit is unable to connect to the Internet via a wireless LAN router (access point).	The wireless LAN router (access point) is turned off.	Turn on the power to the wireless LAN router (access point).	—
	The unit and the wireless LAN router (access point) are too far apart.	Place the unit and the wireless LAN router (access point) closer to each other.	—
	There is an obstacle between the unit and the wireless LAN router (access point).	Move the unit and the wireless router (access point) to locations with no obstacles between them.	—
A wireless network cannot be found.	A device emitting electromagnetic waves (such as a microwave oven, a wireless device and so on) may be located nearby.	When connecting the unit wirelessly, do not use it near devices that emit electromagnetic waves.	—
	Access to the network is restricted by the firewall settings of the wireless LAN router (access point).	Check the firewall settings of the wireless LAN router (access point).	—
The computer (server) cannot be detected.	The media sharing settings on the PC (or server) may be incorrect.	Modify the media sharing settings so that the unit will be able to access the folders on the PC (or server).	—
	Access is restricted due to the security settings on the PC (or server) or router.	Check the security settings on the PC (or server) or router.	—
	The unit and the PC are not connected to the same network.	Check the network connection and the router settings to make sure that they are connected to the same network.	—
Files on the PC (or server) are not displayed (or played back).	The file format is not supported by the unit or the PC (or server).	Be sure to use a file format that is supported by the unit and the PC.	52
Unable to play the Internet radio.	The selected Internet radio station is currently out of service.	There may be a network problem at the radio station, or the broadcasting service may have been stopped. Try to play the station later or select another station.	—
	The currently-selected radio station is broadcasting silence.	Some Internet radio stations broadcast silence at certain times of the day. In this case, there is no problem with the reception, but no audio will be produced. Try to play the station later or select another station.	—
	Access to the network is restricted by the firewall settings of the network devices (such as the router).	Check the firewall settings on your devices. The Internet radio can be played only through the port designated by each radio station. The port number varies depending on the radio station.	—

Problem	Cause	Solution	Page
The iPhone does not detect the unit when using AirPlay.	You may be using a router that supports multiple SSIDs.	The router's network separator function may be blocking access to the unit. If you are connecting an iPhone to the unit, use an SSID that allows access to the unit. (Try to connect to the Primary SSID.)	—
The unit is not detected when using a dedicated application on a mobile device.	The unit and the mobile device are not on the same network.	Check the network connection and the router settings to make sure that they are connected to the same network.	—
	You may be using a router that supports multiple SSIDs.	The router's network separator function may be blocking access to the unit. If you are connecting an iPhone to the unit, use an SSID that allows access to the unit. (Try to connect to the Primary SSID.)	—
The firmware on this unit failed to update via the network.	The network connection may not be good.	Try updating again after a while. Alternatively, update the firmware using a USB memory device.	45
The unit is unable to connect to the wireless LAN router (access point).	MAC address filtering may have been enabled on the wireless LAN router (access point).	The unit is unable to connect to the router if MAC address filtering is enabled. Change the setting on the wireless LAN router (access point), and try to connect the unit again.	—

Display messages

Message	Meaning	Solution
Access denied	Access to the PC (or server) has been denied.	Modify the media sharing settings so that the unit will be able to access the folders on the PC (or server) (page 32).
Access error	Unable to access the USB device.	Turn off the power to the unit, turn it on again, and then reconnect the USB device. If the problem persists, move the music files to another USB device and try again.
	There is a problem with the signal path from the network to the unit.	Make sure that your router and modem are turned on.
		Check the connection between the unit and your router (or hub) (page 18).
No content	There are no playable files in the selected folder.	Select a folder that contains files supported by the unit.
Please wait	The unit is preparing to connect to the network.	Wait until the message disappears. If the message stays more than 3 minutes, turn off the unit and then turn it on again.
Unable to play	Unable to play a music file stored on your USB device.	Check to see whether the file format is supported by the unit. If other devices are unable to play the file, the song data might be corrupt.
	Unable to play a music file stored on your PC (or server).	Check to see whether the file format is supported by the unit. For information on music files supported by this unit, please refer to "Supported devices and file formats" (page 52). If the unit supports the file format, but still cannot play any files, the network may be overloaded with heavy traffic.
Version error	Firmware update failed.	Update the firmware again (page 45).

Supported devices and file formats

The following devices and file formats can be used by the unit.

Supported devices

Bluetooth devices

- You can use *Bluetooth* devices that support the A2DP protocol.
- Yamaha does not guarantee the connections of all *Bluetooth* devices.

USB storage device

- This unit supports USB mass storage class devices (e.g., flash memories or portable audio players) using the FAT16 or FAT32 format.
- Do not connect any devices other than USB mass storage class devices (such as USB chargers or USB hubs), PCs, card readers, an external HDD, etc.
- USB devices with encryption cannot be used.
- Certain USB devices may not be recognized by the unit, or certain features may not be compatible with the unit, depending on the model or manufacturer of the USB storage device.

AirPlay

AirPlay works with iPhone, iPad, and iPod touch with iOS 4.3.3 or later, Mac with OS X Mountain Lion or later, and PC with iTunes 10.2.2 or later.

Compatible models (as of June, 2017)

Made for.

iPhone 7 Plus, iPhone 7, iPhone SE, iPhone 6s Plus, iPhone 6s, iPhone 6 Plus, iPhone 6, iPhone 5s, iPhone 5c, iPhone 5, iPhone 4s

iPad Pro (9.7" and 12.9"), iPad mini 4, iPad Air 2, iPad mini 3, iPad Air

iPad mini 2, iPad mini, iPad (3rd and 4th generation), iPad 2

iPod touch (5th and 6th generations)

File formats

USB, PC/NAS

File	Sampling frequency (kHz)	Bit depth (bit)	Bitrate (kbps)	Number of channels	Support for gapless playback
WAV *	32/44.1/48/ 88.2/96/ 176.4/192	16/24	-	2	✓
MP3	32/44.1/48	-	8 - 320	2	-
WMA	32/44.1/48	-	8 - 320	2	-
MPEG-4 AAC	32/44.1/48	-	8 - 320	2	-
FLAC	32/44.1/48/ 88.2/96/ 176.4/192	16/24	-	2	✓
ALAC	32/44.1/48/ 88.2/96	16/24	-	2	✓
AIFF	32/44.1/48/ 88.2/96/ 176.4/192	16/24	-	2	✓
DSD	2.8 MHz/ 5.6 MHz	1	-	2	-

* Linear PCM format only

- To play back FLAC files stored on your PC/NAS, you must install server software that supports the sharing of FLAC files via DLNA on your PC, or use a NAS device that supports FLAC files.
For more information, refer to the instruction manual for the server software.
- Digital Rights Management (DRM) encoded content cannot be played back.

Trademarks

The trademarks used in this manual are as follows.



Supports iOS 7 or later for setup using Wireless Accessory Configuration.

"Made for iPod," "Made for iPhone," and "Made for iPad" mean that an electronic accessory has been designed to connect specifically to iPod, iPhone, or iPad, respectively, and has been certified by the developer to meet Apple performance standards.

Apple is not responsible for the operation of this device or its compliance with safety and regulatory standards.

Please note that the use of this device with iPod, iPhone, or iPad may affect wireless performance.

iTunes, AirPlay, iPad, iPhone, iPod, and iPod touch are trademarks of Apple Inc., registered in the U.S. and other countries.

iPad Air and iPad mini are trademarks of Apple Inc.

App Store is a service mark of Apple Inc.

Windows™

Windows is a registered trademark of Microsoft Corporation in the United States and other countries.

Internet Explorer, Windows Media Audio and Windows Media Player are either registered trademarks or trademarks of Microsoft Corporation in the United States and/or other countries.

Android™ Google Play™

Android and Google Play are trademarks of Google Inc.



The Wi-Fi CERTIFIED™ Logo is a certification mark of Wi-Fi Alliance®.

The Wi-Fi Protected Setup™ Identifier Mark is a certification mark of Wi-Fi Alliance®.



The Bluetooth® word mark and logos are registered trademarks owned by Bluetooth SIG, Inc., and any use of such marks by Yamaha Corporation is under license.

Bluetooth protocol stack (Blue SDK)

©1999-2014 OpenSynergy GmbH

All rights reserved. All unpublished rights reserved.



MusicCast is a trademark or registered trademark of Yamaha Corporation.

Explanations regarding GPL/LGPL

This product utilizes GPL/LGPL open-source software in some sections.

You have the right to obtain, duplicate, modify, and redistribute only this open-source code.

For information on GPL/LGPL open source software, how to obtain it, and the GPL/LGPL license, refer to the Yamaha Corporation website:

<http://download.yamaha.com/sourcecodes/musiccast/>



Yamaha Eco-Label is a mark that certifies products of high environmental performance.

Specifications

The specifications of this unit are as follows.

Output Jacks

- Analog audio x 1 (RCA Unbalanced)
- Digital audio
 - Optical x 1
 - Coaxial x 1

Other Jacks

- USB×1 (USB2.0)
- NETWORK (Wired) x 1 (100Base-TX/10Base-T)
- NETWORK (Wireless) x 1 (IEEE802.11b/g/n)

USB

- Mass Storage Class USB Memory
- Current Supply Capacity: 1.0 A

Bluetooth

- Sink Function
 - Source Device to this unit (ex. Smartphone/Tablet)
 - Supported codec: SBC, AAC
- Source Function
 - This unit to Sink Device (ex. *Bluetooth* Headphone)
 - Supported codec: SBC
 - Capable of Play/Stop Operation from Sink Device (ex. *Bluetooth* Headphone)
- Supported profile..... A2DP, AVRCP
- *Bluetooth* version..... Ver. 2.1+EDR
- Wireless output..... Bluetooth Class 2
- Radio Frequency (Operational Frequency)
 - 2402 MHz to 2480 MHz
- Maximum Output Power (E.I.R.P)..... 4.0 dBm (2.5 mW)
- Maximum communication distance
 - 10 m (33 ft) without interference

Network

- Compatible with DLNA ver. 1.5
- AirPlay supported
- Internet Radio

Wireless Network

- Wireless Network Standard: IEEE802.11b/g/n
- Radio Frequency Band: 2.4 GHz
- WPS (Wi-Fi Protected Setup)
 - Push-Button-Method
- Capable of Direct Connection with Mobile Device
- Available Security Method
 - WEP
 - WPA2-PSK (AES)
 - Mixed Mode
- Radio Frequency (Operational Frequency)
 - 2412 MHz to 2472 MHz
- Maximum Output Power (E.I.R.P)..... 17.5 dBm (56.2 mW)

Audio Section

- Output level (1 kHz, 0 dB, Fs 44.1 kHz)..... 2.0 ±0.3 V
- Signal to Noise Ratio (IHF-A Network)
 - (1 kHz, 0 dB, Fs 44.1 kHz) 110 dB or higher
- Dynamic range
 - (1 kHz, 0 dB, Fs 44.1 kHz) 100 dB or higher
- Harmonic Distortion
 - (1 kHz, 0 dB, Fs 44.1 kHz) 0.003% or lower
- Frequency Response
 - Fs 44.1 kHz 2 Hz to 20 kHz, -3 dB
 - Fs 48 kHz 2 Hz to 24 kHz, -3 dB
 - Fs 96 kHz 2 Hz to 48 kHz, -3 dB
 - Fs 192 kHz 2 Hz to 96 kHz, -3 dB

General

- Power Supply
 - [Canada model] AC 120 V, 60 Hz
 - [General model] AC 110-240 V, 50/60 Hz
 - [Australia model] AC 240 V, 50 Hz
 - [U.K. and Europe models] AC 230 V, 50 Hz
 - [Asia model]..... AC 220-240 V, 50/60 Hz
- Power Consumption..... 12 W
- Standby Power Consumption 0.1 W
- Network Standby On/*Bluetooth* Standby Off
 - Wired 1.6 W
 - Wireless (WiFi) 1.5 W
 - Wireless Direct 1.7 W
- Network Standby On/*Bluetooth* Standby On 1.7 W
- Dimensions (W x H x D) 435 × 87 × 289 mm
(17-1/8" × 3-3/8" × 11-3/8")
- Reference Dimensions (with wireless antenna upright)
 - (W x H x D) 435 × 148 × 289 mm
(17-1/8" × 5-7/8" × 11-3/8")
- Weight 2.7 kg (6.0 lbs)

* The contents of this manual apply to the latest specifications as of the publishing date. To obtain the latest manual, access the Yamaha website and download the manual file.

Information for users on collection and disposal of old equipment and used batteries:



These symbols on the products, packaging, and/or accompanying documents mean that used electrical and electronic products and batteries should not be mixed with general household waste. For proper treatment, recovery and recycling of old products and used batteries, please take them to applicable collection points, in accordance with your national legislation.



By disposing of these products and batteries correctly, you will help to save valuable resources and prevent any potential negative effects on human health and the environment which could otherwise arise from inappropriate waste handling.



For more information about collection and recycling of old products and batteries, please contact your local municipality, your waste disposal service or the point of sale where you purchased the items.

For business users in the European Union:

If you wish to discard electrical and electronic equipment, please contact your dealer or supplier for further information.



Information on Disposal in other Countries outside the European Union:

These symbols are only valid in the European Union. If you wish to discard these items, please contact your local authorities or dealer and ask for the correct method of disposal.

Note for the battery symbol (bottom two symbol examples):

This symbol might be used in combination with a chemical symbol. In this case it complies with the requirement set by the EU Battery Directive for the chemical involved.

Cd

(weee_battery_eu_en_02)

EN

SIMPLIFIED EU DECLARATION OF CONFORMITY

Hereby, Yamaha Music Europe GmbH declares that the radio equipment type [NP-S303] is in compliance with Directive 2014/53/EU. The full text of the EU declaration of conformity is available at the following internet address:
<https://europe.yamaha.com/en/support/compliance/doc.html>

Important Notice: Guarantee Information for customers in EEA* and Switzerland**English**

For detailed guarantee information about this Yamaha product, and Pan-EEA* and Switzerland warranty service, please either visit the website address below (Printable file is available at our website) or contact the Yamaha representative office for your country. * EEA: European Economic Area

<http://europe.yamaha.com/warranty/>

Yamaha Global Site
<http://www.yamaha.com/>
Yamaha Downloads
<http://download.yamaha.com/>

Manual Development Group
© 2017 Yamaha Corporation

Published 06/2017 IP-A0
Printed in Malaysia

ZX87440