

# YAMAHA

## MULTITRACK MD RECORDER

# MD4

## Owner's Manual

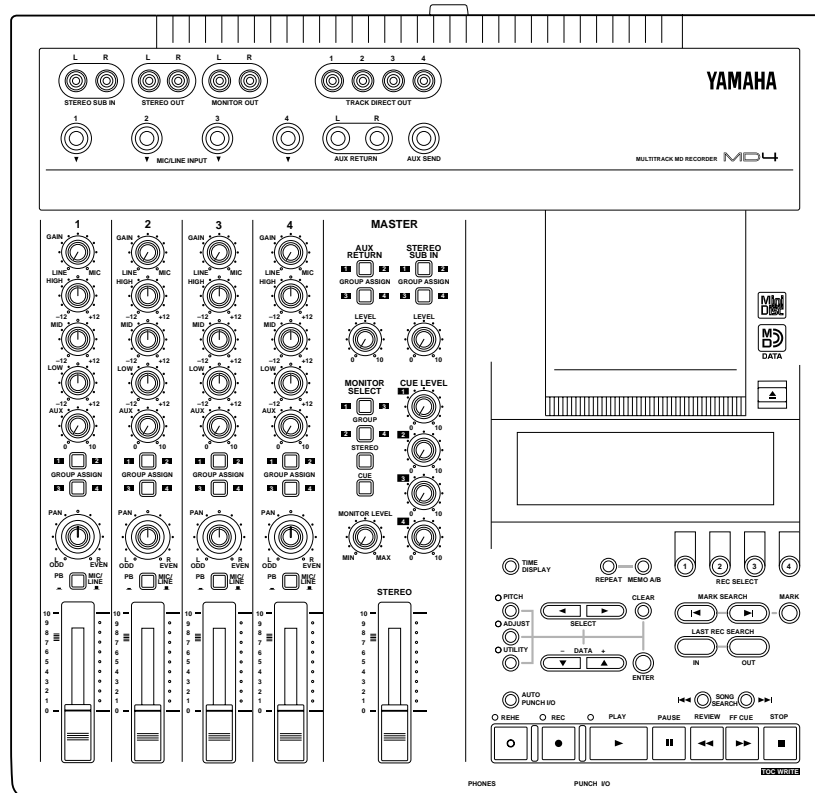

## FCC INFORMATION (U.S.A.)

### 1. IMPORTANT NOTICE: DO NOT MODIFY THIS UNIT!

This product, when installed as indicated in the instructions contained in this manual, meets FCC requirements. Modifications not expressly approved by Yamaha may void your authority, granted by the FCC, to use the product.

2. IMPORTANT: When connecting this product to accessories and/or another product use only high quality shielded cables. Cable/s supplied with this product MUST be used. Follow all installation instructions. Failure to follow instructions could void your FCC authorization to use this product in the USA.

3. NOTE: This product has been tested and found to comply with the requirements listed in FCC Regulations, Part 15 for Class "B" digital devices. Compliance with these requirements provides a reasonable level of assurance that your use of this product in a residential environment will not result in harmful interference with other electronic devices. This equipment generates/uses radio frequencies and, if not installed and used according to the instructions found in the users manual, may cause interference harmful to the operation of other electronic devices. Compliance with FCC regulations does not guarantee that interference will not occur in all installations. If this product is found to be the source of interference, which can be determined by turning the unit "OFF" and "ON", please try to eliminate the problem by using one of the following measures:  
Relocate either this product or the device that is being affected by the interference.

Utilize power outlets that are on different branch (circuit breaker or fuse) circuits or install AC line filter/s.

In the case of radio or TV interference, relocate/reorient the antenna. If the antenna lead-in is 300 ohm ribbon lead, change the lead-in to coaxial type cable. If these corrective measures do not produce satisfactory results, please contact the local retailer authorized to distribute this type of product. If you can not locate the appropriate retailer, please contact Yamaha Corporation of America, Electronic Service Division, 6600 Orangethorpe Ave, Buena Park, CA 90620

## IMPORTANT

Please record the serial number of this unit in the space below.

Serial No.:

The serial number is located on the bottom of the unit.  
Retain this Owner's Manual in a safe place for future reference.

## IMPORTANT NOTICE FOR THE UNITED KINGDOM

### Connecting the Plug and Cord

IMPORTANT: The wires in this mains lead are coloured in accordance with the following code:

BLUE : NEUTRAL

BROWN : LIVE

As the colours of the wires in the mains lead of this apparatus may not correspond with the coloured markings identifying the terminals in your plug proceed as follows:

The wire which is coloured BLUE must be connected to the terminal which is marked with the letter N or coloured BLACK.

The wire which is coloured BROWN must be connected to the terminal which is marked with the letter L or coloured RED.

Making sure that neither core is connected to the earth terminal of the three pin plug.

## Laser Diode Properties

\* Material : GaAlAs

\* Wavelength : 780–790 nm

\* Emission Duration : Continuous

\* Laser Output Power : Less than 44.6  $\mu$ W

(Note) Laser output is measured at a distance of 20cm from the object lens on the optical pick-up head.



This unit is classified as a Class 1 laser product. The CLASS 1 LASER PRODUCT label is located on the exterior.

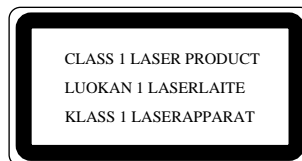

Klassmärkning för Finland.

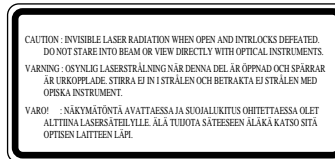

- This label is not placed on USA model and Canadian model.
- This label is placed on the lid.
- Varningsanvisning för laserstrålning. Placerad i apparaten.

## CAUTION

USE OF CONTROLS OR ADJUSTMENTS OR PERFORMANCE OF PROCEDURES OTHER THAN THOSE SPECIFIED HEREIN MAY RESULT IN HAZARDOUS RADIATION EXPOSURE.

## ADVARSEL

Usynlig laserstrålning ved åbning. Undgå udsættelse for stråling.

## VAROITUS

Laitteen käyttäminen muulla kuin tässä käyttöohjeessa mainitulla tavalla saattaa altistaa käyttäjän turvallisuusluokan 1 ylittävälle näkymättömälle lasersäteilylle.

## VARNING

Om apparaten används på annat sätt än i denna bruksanvisning specificerats, kan användaren utsättas för osynlig laserstrålning, som överskrider gränsen för laserklass 1.

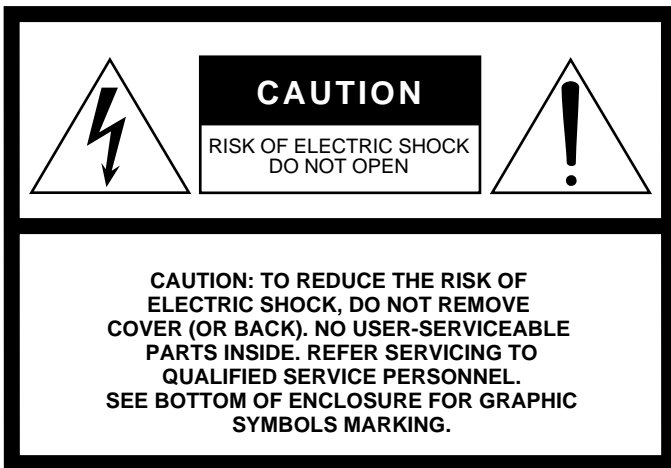

## • Explanation of Graphical Symbols



The exclamation point within an equilateral triangle is intended to alert the user to the presence of important operating and maintenance (servicing) instructions in the literature accompanying the product.

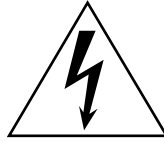

The lightning flash with arrowhead symbol within an equilateral triangle is intended to alert the user to the presence of uninsulated “dangerous voltage” within the product’s enclosure that may be of sufficient magnitude to constitute a risk of electric shock to persons.

# SAFETY INSTRUCTIONS

1. Read Instructions — All the safety and operating instructions should be read before the appliance is operated.
2. Retain Instructions — The safety and operating instructions should be retained for future reference.
3. Heed Warnings — All warnings on the appliance and in the operating instructions should be adhered to.
4. Follow Instructions — All operating and use instructions should be followed.
5. Water and Moisture — The appliance should not be used near water – for example, near a bathtub, washbowl, kitchen sink, laundry tub, in a wet basement, or near a swimming pool, and the like.
6. Carts and Stands — The appliance should be used only with a cart or stand that is recommended by the manufacturer.
  - 6A An appliance and cart combination should be moved with care. Quick stops, excessive force, and uneven surfaces may cause the appliance and cart combination to overturn.
7. Wall or Ceiling Mounting — The appliance should be mounted to a wall or ceiling only as recommended by the manufacturer.
8. Ventilation — The appliance should be situated so that its location or position does not interfere with its proper ventilation. For example, the appliance should not be situated on a bed, sofa, rug, or similar surface that may block the ventilation openings; or, placed in a built-in installation, such as a bookcase or cabinet that may impede the flow of air through the ventilation openings.
9. Heat — The appliance should be situated away from heat sources such as radiators, heat registers, stoves, or other appliances (including amplifiers) that produce heat.
10. Power Sources — The appliance should be connected to a power supply only of the type described in the operating instructions or as marked on the appliance.
11. Grounding or Polarization — The precautions that should be taken so that the grounding or polarization means of an appliance is not defeated.
12. Power-Cord Protection — Power-supply cords should be routed so that they are not likely to be walked on or pinched by items placed upon or against them, paying particular attention to cords at plugs, convenience receptacles, and the point where they exit from the appliance.
13. Cleaning — The appliance should be cleaned only as recommended by the manufacturer.
14. Nonuse Periods — The power cord of the appliance should be unplugged from the outlet when left unused for a long period of time.
15. Object and Liquid Entry — Care should be taken so that objects do not fall and liquids are not spilled into the enclosure through openings.
16. Damage Requiring Service — The appliance should be serviced by qualified service personnel when:
  - A. The power-supply cord or the plug has been damaged; or
  - B. Objects have fallen, or liquid has been spilled into the appliance; or
  - C. The appliance has been exposed to rain; or
  - D. The appliance does not appear to operate normally or exhibits a marked change in performance; or
  - E. The appliance has been dropped, or the enclosure damaged.
17. Servicing — The user should not attempt service the appliance beyond that described in the operating instructions.



# Important

## Read the Following Before Operating MD4

### Warnings

- Do not locate MD4 in a place subject to excessive heat or in direct sunlight. This could be a fire hazard.
- Do not place MD4 in a place subject to excessive humidity or dust. This could be a fire and electrical shock hazard.
- Connect the supplied AC power cord only to an AC outlet of the type stated in this *Owner's Manual* or as marked on the main unit. Failure to do so is a fire and electrical shock hazard.
- Do not plug several devices into the same AC outlet. This can overload the AC outlet, and can be a fire and electrical shock hazard. It may also affect the performance of some devices.
- Do not place heavy objects on the power cord. A damaged power cord is a potential fire and electrical shock hazard.
- If the power cord is damaged (i.e., cut or a bare wire is exposed), ask your dealer for a replacement. Using MD4 in this condition is a fire and shock hazard.
- Hold the AC power cord plug when disconnecting from an AC outlet. Never pull the cord. Damaging the power cord in this way is a potential fire and electrical shock hazard.
- Do not place small metal objects on top of MD4. Metal objects inside MD4 are a fire and electrical shock hazard.
- Do not block the MD4 ventilation holes. MD4 has ventilation holes at the rear to prevent the internal temperature from rising. Blocked ventilation holes are a fire hazard.
- Do not try to modify MD4. This could be a fire and electrical shock hazard.
- MD4 operating temperature is between 5°C and 35°C (41°F and 95°F).

### Cautions

- Turn off all audio devices and speakers when connecting to MD4. Refer to the owner's manual for each device. Use the correct cables and connect as specified.
- MD4 is a precision device. Handle it with care.
- Handle MD DATA discs with care.
- If you notice any abnormality—such as smoke, odor, or noise—turn off MD4 immediately. Remove the AC power cord from the AC outlet. Confirm that the abnormality is no longer present. Consult your dealer for repair. Using MD4 in this condition is a fire and shock hazard.
- If a foreign object or water gets inside MD4, turn it off immediately. Remove the AC power cord from the AC outlet. Consult your dealer for repair. Using MD4 in this condition is a fire and electrical shock hazard.
- If you plan not to use MD4 for a long period of time (such as when you are on vacation), remove the AC power cord from the AC outlet. Leaving MD4 connected is a fire hazard.
- Do not use benzene, thinner, cleaning detergent, or a chemical cloth to clean MD4.
- Use only a soft, dry cloth to clean MD4.

## Interference

MD4 uses high-frequency digital circuits that may cause interference on radios and televisions placed close to it. If interference does occur, relocate the affected equipment.

## Copyright

© 1996 Yamaha Corporation. All rights reserved.

No part of the MD4 software or this *Owner's Manual* may be reproduced or distributed in any form or by any means without the prior written authorization of Yamaha Corporation.

## Trademarks

MD DATA and MiniDisc are trademarks of Sony Corporation.

US and foreign patents licensed from Dolby Laboratories Licensing Corporation.

All trademarks are the property of their respective holders.

## Package Contents

The MD4 package should contain the following items. Make sure that you have them all.

- MD4 Multitrack Recorder
- AC power cord
- MD DATA disc
- This Owner's Manual

Contact your Yamaha dealer if something is missing.

## Keep This Manual For Future Reference

---

# Contents

<b>1. Welcome to MD4</b> . . . . .	<b>1</b>
MD4 Features . . . . .	1
Mixer . . . . .	1
Recorder . . . . .	1
Buying Discs for MD4 . . . . .	2
MD4 TOC . . . . .	2
<b>2. Touring MD4</b> . . . . .	<b>3</b>
Topside View . . . . .	3
Input Channels . . . . .	4
Master Section . . . . .	5
Display . . . . .	6
Disc Transport Section . . . . .	8
Topside Connectors . . . . .	10
Front Connectors . . . . .	11
Rear . . . . .	11
<b>3. The First Session</b> . . . . .	<b>12</b>
Quick-Start System . . . . .	12
Connecting the Power Cord . . . . .	13
Turning On MD4 . . . . .	13
Loading a Disc . . . . .	13
Recording the First Track . . . . .	13
Listening to the First Track . . . . .	14
Overdubbing . . . . .	15
Mixdown . . . . .	16
An Overview of Multitrack Recording . . . . .	17
Basic Multitracking . . . . .	17
Advanced Multitracking . . . . .	17
About Monitoring . . . . .	18
<b>4. Recording &amp; Mixing Techniques</b> . . . . .	<b>19</b>
Recording a New Song . . . . .	19
Searching for the Blank Top . . . . .	19
Setting the Recording Mode . . . . .	19
Recording . . . . .	20
Titling Discs & Songs . . . . .	20
Manual Punch In/Out . . . . .	21
Using the REC Button . . . . .	21
Using the REC SELECT buttons . . . . .	22
Using a Footswitch . . . . .	23
Auto Punch In/Out . . . . .	24
Setting the In/Out Points “On-the-Fly” . . . . .	24
Another Way to Set the IN/OUT Points . . . . .	24
Rehearsing Auto Punch . . . . .	25
Performing Auto Punch for Real . . . . .	26
Auto Punch with a Footswitch . . . . .	27
Setting the Pre-Roll & Post-Roll Times . . . . .	28
Ping-Pong Recording . . . . .	29

---

Preparing for Ping-Pong .....	30
Rehearsing the Ping-Pong .....	30
Performing the Ping-Pong for Real .....	30
Checking the Ping-Pong Operation .....	31
Ping-Pong with Overdub .....	31
Pitch .....	32
Adjusting the Pitch .....	32
Resetting the Pitch .....	32
Using a Footswitch .....	33
Applying Effects .....	34
Applying Effects at Mixdown .....	34
Applying Effects when Recording .....	35
Applying Effects with Ping-Pong .....	35
<b>5. Quick Search Functions .....</b>	<b>36</b>
Searching for Songs .....	36
Searching by Time .....	36
Searching for the Last Rec IN and OUT Points .....	36
Searching for Markers .....	36
Inserting Markers .....	37
Marker Indicators .....	37
Adjusting Markers .....	38
Erasing Markers .....	39
<b>6. Repeat, Cue List &amp; Program Play .....</b>	<b>40</b>
One Song Repeat .....	40
All Song Repeat .....	40
A–B Repeat .....	41
Cue List Playback & Copy .....	42
Program Playback .....	43
<b>7. Editing Songs &amp; Tracks .....</b>	<b>44</b>
Copying a Song .....	44
Dividing a Song .....	45
Combining Songs .....	46
Track-to-Track Copy .....	47
Erasing Tracks .....	48
Erasing Songs .....	48
<b>8. MD4 &amp; MIDI .....</b>	<b>49</b>
Using MD4 in a Synchronized MIDI System .....	49
About Tempo Maps .....	49
Setting Up a Synchronized MIDI System .....	50
Using MTC .....	51
Setting MD4 for MTC Operation .....	51
Setting the MIDI Sequencer .....	51
MTC Cabling Note .....	51
Using MIDI Clock .....	52
Setting the MIDI Sequencer .....	52
Adding Meter Changes to a Tempo Map .....	52
Adding Tempo Changes to a Tempo Map .....	53
Inserting Steps in a Tempo Map .....	54

---

---

Deleting Steps in a Tempo Map .....	54
Saving a Tempo Map .....	55
Loading a Tempo Map .....	55
Tempo Map Chart .....	56
<b>9. MD4 Applications .....</b>	<b>57</b>
One-Take Recording .....	57
MIDI Home Studio .....	58
Using MD4 with a Sub-Mixer .....	59
Recording a Stereo Source .....	60
<b>10. Beyond the Basics .....</b>	<b>61</b>
AUX RETURN .....	61
EQ .....	61
Markers .....	61
Pitch .....	62
Monitoring .....	62
Mixdown .....	63
<b>11. Q&amp;A Section .....</b>	<b>64</b>
<b>Troubleshooting .....</b>	<b>66</b>
<b>Appendix .....</b>	<b>67</b>
MD4 Transport Modes .....	67
Display Messages .....	68
Signal Flow Chart .....	69
Specifications .....	70
Recorder .....	70
Mixer .....	70
General .....	70
Block Diagram .....	71
Dimensions .....	71
<b>Glossary .....</b>	<b>72</b>
<b>Index .....</b>	<b>75</b>
<b>MIDI Implementation Chart ..</b>	<b>End of Manual</b>



---

# 1 Welcome to MD4

Thank you for choosing the Yamaha MD4 Multitrack MD Recorder. MD4 is the world's first multitrack recorder to use the MiniDisc format, with its superior sound quality and quick search capabilities. To take best advantage of your MD4, read this *Owner's Manual* thoroughly.

## MD4 Features

### Mixer

The mixer section is a four-input channel, four-group analog mixer.

- Input channels feature continuously variable GAIN controls, which can handle both microphone and line-level signals with ease.
- Musical three-band EQ (High, Mid, Low) on each input channel provides flexible tone-shaping capabilities.
- Aux send with stereo return for an external effects processor.
- Flexible monitoring of Group, CUE, and Stereo buses.
- Direct outputs for direct connection to another mixer.
- Stereo sub inputs for mixer cascading.

### Recorder

The recorder section is a four-track recorder based on the MD DATA audio format, which has several advantages over tape-based multitrackers. With a tape-based recorder, for example, you have to keep at least one track free for ping-pong. With MD4, however, you can record on all four tracks and then ping-pong (i.e., four-track playback with ping-pong). This is because MD4 can simultaneously play and record on the same track. This feature provides greater creative freedom when planing tracks.



- Superior sound quality that is unaffected by repeated overdubs and ping-pong operations.
- Zero wow and flutter and pitch fluctuation.
- Recording time: 37 minutes for 4-track, 74 minutes for stereo, and 148 minutes for mono.
- Four-track playback with ping-pong.
- Quick search for Song Start, Song End, Last Record IN/OUT points, Direct Time Locate, and up to eight markers for each song.
- Precise punch in/out with 11-millisecond accuracy.
- Editing includes Song Combine, Song Divide, and cue list-style playback.
- Disc and song titling for easy identification.
- Repeat modes include One Song, All Song, A–B, and Auto Punch Rehearse.
- FF CUE and Review at 2X and 4X playback speed.
- Variable pitch of approximately  $\pm 6.5\%$ .
- Clear FLD (Fluorescent Display) shows signal levels, mode, status, and Total, Remaining, and Elapsed times.
- MTC (MIDI Timecode) or MIDI Clock (with Tempo Map) output for synchronization within a MIDI-based system.

For some more quick answers on MD4, see the *Q&A Section* on page 64.

## Buying Discs for MD4

It's important that you buy the correct type of disc for use with your MD4. For 4-track recording and playback, you must use MD DATA discs. Normal MiniDiscs can only be used for 2-track recording and playback.

MD DATA discs are used as a storage media for computers. MD4 uses the MD DATA audio format. MiniDiscs are also referred to as MD discs, although they are used only for music.

Type	Logo	Description
MD DATA		MD DATA discs are for computer data storage applications. You can purchase them at computer stores. This is the type of disc you should buy for 4-track recording and playback with your MD4. Note that there are two types available: <i>playback only</i> and <i>rewritable</i> . You should buy the rewritable type.
MiniDisc		MiniDiscs are used only for music. Two types are available: <i>playback only</i> and <i>recordable</i> . MD4 can record up to two tracks on the <i>recordable</i> type and play the <i>playback only</i> type.

MD DATA discs that have been used to store computer data must be formatted before they can be used with MD4. See *Erasing Songs* on page 48.

Normal MiniDisc decks cannot play MD DATA discs.

MiniDiscs recorded on MD4 can be played on a normal MiniDisc deck.

MiniDisc recordings made on a normal MiniDisc deck can be edited on MD4. MiniDiscs that contain songs that were digitally copied from a commercial CD, however, cannot be edited due to the SCMS protection system.

## MD4 TOC

TOC refers to the Table Of Contents area on a disc. The TOC contains information about what is recorded on the disc, the disc title, song titles, and so on. The TOC EDIT indicator lights up when the TOC needs to be updated, usually after a new recording or edit. You must update the TOC before ejecting a disc or turning off MD4. It's also a good idea to update the TOC at regular intervals just in case of a power failure. Failure to update the TOC can result in data being lost. Even if you've recorded something correctly, if the TOC isn't updated and MD4 is turned off, the power cord accidentally disconnected, or a power failure occurs, that data will be lost.

*Note:* If you press the EJECT button while TOC EDIT is shown on the display, the disc will not eject. Press [TOC WRITE] to update the TOC, and then eject the disc.

# 2 Touring MD4

This chapter takes you on a tour of MD4, identifying the various parts to help you become familiar with your new recorder.

## Topside View

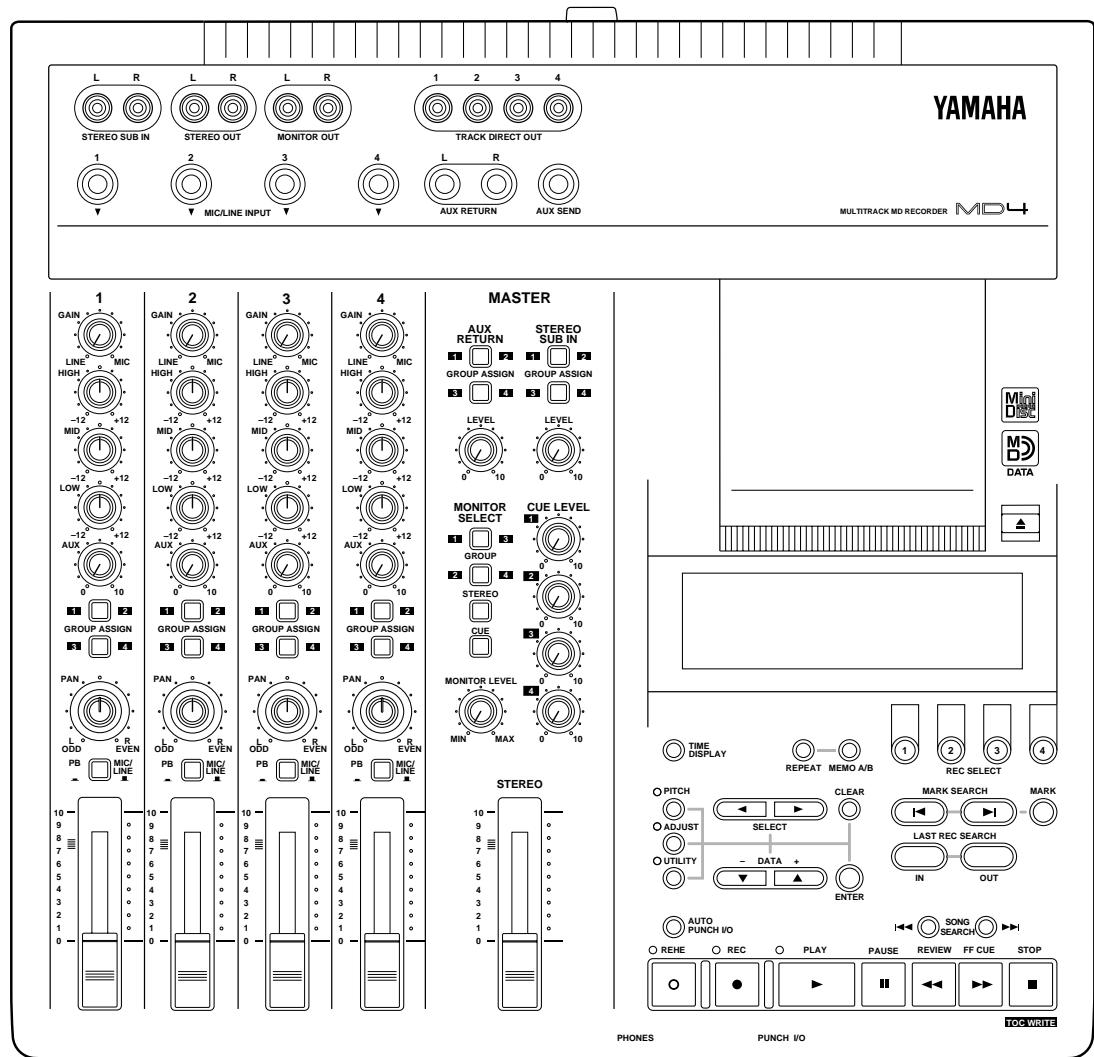

The individual sections of MD4 are explained on the following pages.

# Input Channels

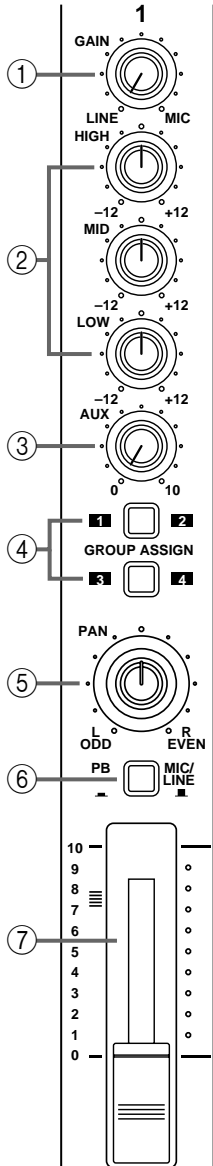

## ① GAIN control

This rotary control adjusts the sensitivity of the MIC/LINE input so that both microphone and line-level signals can be handled with ease.

## ② EQ controls

These rotary controls are used to boost and cut the high, middle, and low frequency bands independently. A flat setting (i.e., no boost or cut) can be set quickly using the control's center detent.

HIGH  $\pm 12$  dB at 12 kHz—shelving type

MID  $\pm 12$  dB at 1 kHz—peaking type

LOW  $\pm 12$  dB at 80 Hz—shelving type

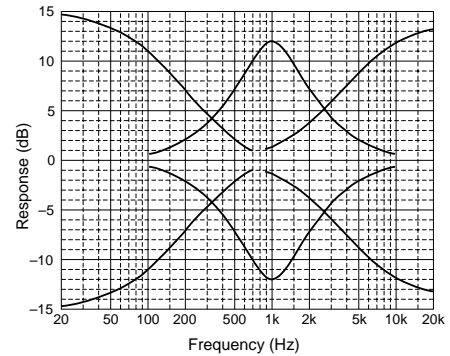

## ③ AUX control

This rotary control is used to send the input channel signal to the AUX SEND output for processing by an external effects processor.

## ④ GROUP ASSIGN switches

These switches are used to assign (i.e., send) the input channel signal to the recorder's tracks. They work in conjunction with the PAN control. For example, with GROUP ASSIGN switch [1–2] ON and the PAN control set midway, the channel signal is sent equally to Tracks 1 and 2. With the PAN control turned fully counterclockwise (L/ODD), however, the channel signal is sent only to Track 1. Likewise, when it is set fully clockwise, the signal is sent only to track 2. The same principle applies to GROUP ASSIGN switch [3–4].

## ⑤ PAN control

This rotary control has two functions: For recording it's used in conjunction with the GROUP ASSIGN switches to assign the input channel signal to even and odd numbered tracks. For mixdown it's used to pan (i.e., position) the signal in the stereo mix.

## ⑥ Input source selector switch

This switch is used to select the signal source for the input channel: MIC/LINE input or PB (disc playback signal).

## ⑦ Fader

This fader has two functions: For recording it's used to adjust the level of the input channel signal that's recorded to a track. For mixdown it's used to balance the input channel signal relative to the other input channel signals. For optimum performance, faders should be positioned about the 7–8 mark.

# Master Section

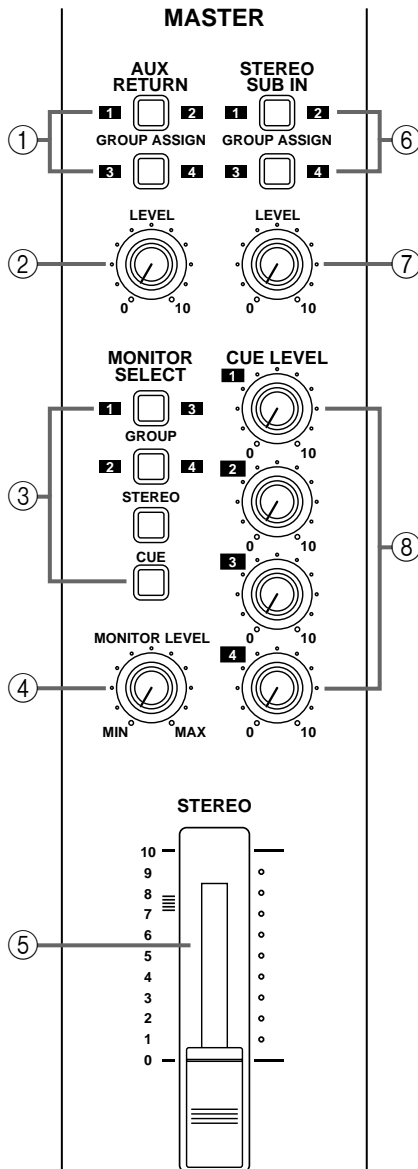

## ① AUX RETURN GROUP ASSIGN switches

These switches are used to assign (i.e., send) the Aux Return signals to the recorder's tracks. The left-channel signal is sent to odd buses 1 and 3. While the right-channel signal is sent to even buses 2 and 4. The Aux Return signals are typically the processed signals returned from a stereo effects processor. Note that the Aux Return signals are always sent to the Stereo bus for mixing regardless of these switch settings.

## ② AUX RETURN LEVEL control

This rotary control adjusts the level of the Aux Return signals that are sent to the Stereo bus for mixing. It's also used in conjunction with the AUX RETURN GROUP ASSIGN switches to adjust the level of the Aux Return signals that are assigned to the recorder's tracks.

## ③ MONITOR SELECT switches

These switches are used to select the signal source for the MONITOR OUT and headphones.

**GROUP**—These switches select the Group buses as the monitor source. This allows you to monitor signals assigned to tracks. When only the [1–3] or [2–4] switch is pressed, the monitor signal is mono. Press both switches to monitor stereo signals.

**STEREO**—This switch selects the Stereo bus as the monitor source. This allows you to monitor the STEREO OUT signal and is typically used during mixdown.

**CUE**—This switch selects the CUE bus as the monitor source. This allows you to monitor track signals, which is useful for punch in/out.

## ④ MONITOR LEVEL control

This rotary control adjusts the level of the monitor signal that is sent to the MONITOR OUT and headphones.

## ⑤ STEREO fader

This fader is used to adjust the level of the stereo signal that is sent to the STEREO OUT. For optimum performance this fader should be positioned about the 7–8 mark.

## ⑥ STEREO SUB IN GROUP ASSIGN switches

These switches are used to assign (i.e., send) the Stereo Sub In signals to the recorder's tracks. The left-channel signal is sent to odd buses 1 and 3. While the right-channel signal is sent to even buses 2 and 4. The Stereo Sub In signals are typically the stereo output signals from another mixer. Note that the Stereo Sub In signals are always sent to the Stereo bus for mixing regardless of these switch settings.

## ⑦ STEREO SUB IN LEVEL control

This rotary control adjusts the level of the Stereo Sub In signals that are sent to the Stereo bus for mixing. It's also used in conjunction with the STEREO SUB IN GROUP ASSIGN switches to adjust the level of the Stereo Sub In signals that are assigned to the recorder's tracks.

## ⑧ CUE LEVEL controls

These controls adjust the level of the CUE signal for each track. During recording, or when no disc is inserted, the CUE source is the signal assigned to a track. During playback, the CUE source is the disc playback signal.

## Display

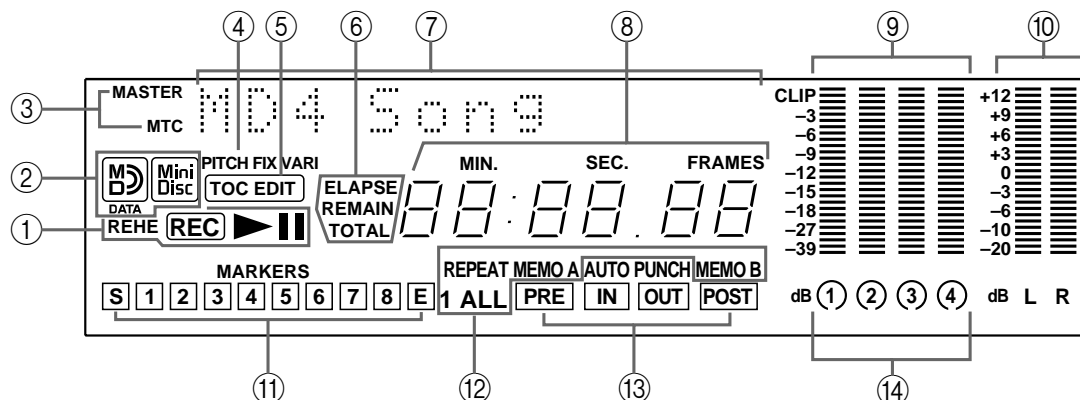

*Note:* For explanation purposes, the illustration above shows most of the available indicators. During normal operation, however, you will not see so many indicators on the display at the same.

### ① Status indicators

These indicators show the current operating mode.

Indicator	Meaning
▶	Normal playback Cue or Review
	Playback is paused
REHE	Rehearse Pause mode
REHE ▶	Rehearsal in progress
REC	Record Pause mode
REC ▶	Recording in progress

### ② Disc type indicators

These indicators show the type of disc loaded: MD DATA Disc or MiniDisc.

### ③ MASTER and MTC indicators

These indicators light up when MIDI synchronization is used. MASTER appears when the MD4 is generating MIDI Clock, and MTC appears when it is generating MIDI Timecode.

### ④ Pitch indicators

These indicators show the current Pitch mode: FIX (fixed) or VARI (variable).

### ⑤ TOC EDIT indicator

The TOC EDIT indicator lights up when the TOC needs to be updated, usually after a new recording or edit.

- 
- ⑥ **Time Counter mode**  
 These indicators show the Time Counter mode.
- ELAPSE**—This mode shows the time position within a song.
- REMAIN**—This mode shows the time remaining for a song or when you are recording a new song, it shows the available time remaining for the song.
- TOTAL**—This mode shows the time position within the entire disc.
- ⑦ **Title and function display**  
 Disc titles, song titles, functions, messages, and other information appear here.
- ⑧ **Time counter**  
 The time counter shows the disc time in minutes, seconds, and frames.
- ⑨ **Track level meters**  
 These track level meters show group signal levels from  $-39$  dB to  $-3$  dB in 9 steps. A CLIP indicator warns of possible distortion caused by signal clipping. With no disc loaded, the meters display group signal levels.
- ⑩ **Stereo level meters**  
 These level meters show the STEREO OUT signal levels from  $-20$  dB to  $+12$  dB in 9 steps.
- ⑪ **Markers**  
 These indicators show the status of the Start, End, and eight markers in between. When a song is recorded, Start and End markers are recorded automatically. You can also add up to eight markers per song while recording is in progress or during subsequent playback. When a song is positioned on or after a marker (stopped, playing, paused, or recording) that marker flashes. When the beginning of a song is located, the Start marker flashes. When the end is located, the End marker flashes.
- ⑫ **Repeat mode indicators**  
 These indicators show the Repeat modes.
- REPEAT 1**—The current song is played repeatedly (One Song Repeat).
- REPEAT ALL**—All songs are played repeatedly (All Song Repeat).
- REPEAT MEMO A–MEMO B**—Playback cycles between memo points A and B (A–B Repeat).
- REPEAT Auto Punch I/O**—Auto Punch In/Out is rehearsed repeatedly.
- ⑬ **AUTO PUNCH, PRE, IN, OUT & POST indicators**  
 The AUTO PUNCH indicator shows that the AUTO PUNCH In/Out function is ON. The IN and OUT indicators light up when the LAST REC IN and OUT points have been set. When a song is positioned on or after the PRE, IN, OUT, or POST point, the corresponding indicator flashes.
- PRE**—This indicator flashes when a song is at the Pre-Roll point.
- IN**—This indicator lights up when the LAST REC IN point has been set and it disappears when a song is located on or after the specified IN point.
- OUT**—This indicator lights up when the LAST REC OUT point has been set and it disappears when a song is located on or after the specified OUT point.
- POST**—This indicator flashes when the song is located at the Post-Roll point.
- ⑭ **Track record indicators**  
 These indicators show which tracks are selected for recording.
-

## Disc Transport Section

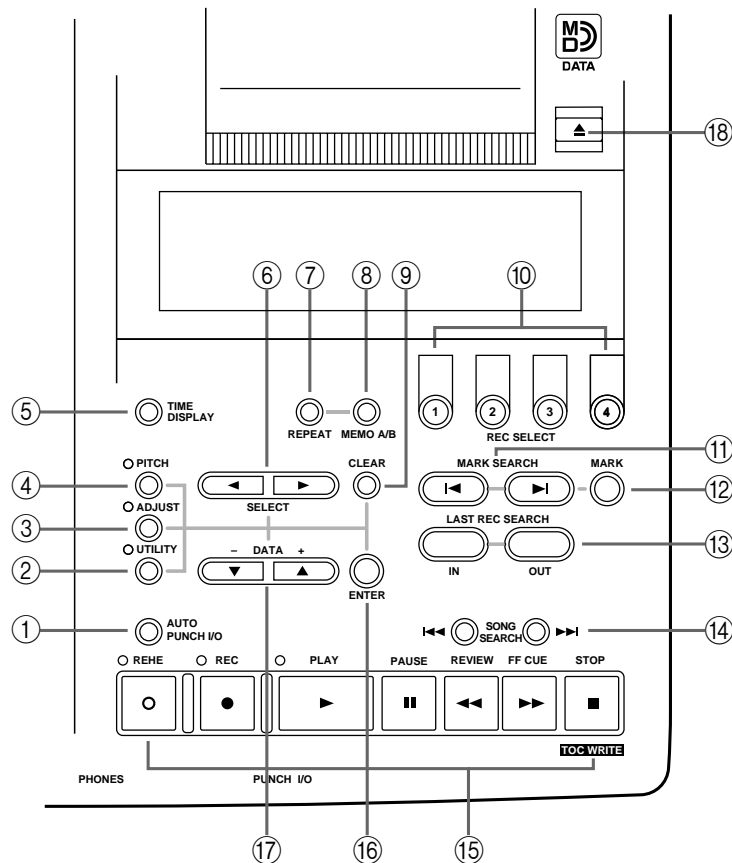

- ① **AUTO PUNCH I/O button**  
This button is used to turn on the Auto Punch In/Out function.
- ② **UTILITY button**  
This button is used to access the following functions: Rec Mode, Text, PrePost Roll, OffLinePunch, Track Erase, Song Erase, Song Copy, Song Divide, Song Combine, Cue List, PRG Play, and MIDI Sync.
- ③ **ADJUST button**  
This button is used to adjust the position of markers and the LAST REC IN and OUT points.
- ④ **PITCH button**  
This button is used to set the Pitch mode: FIX (fixed) or VARI (variable).
- ⑤ **TIME DISPLAY button**  
This button is used to select the Time Counter mode: ELAPSE, REMAIN, or TOTAL.
- ⑥ **SELECT buttons**  
These buttons are used to select items on the display.
- ⑦ **REPEAT button**  
This button is used to select the One Song, All Song, A–B, and Auto Punch Rehearse Repeat modes. It's also be used to cancel A–B Repeat mode.
- ⑧ **MEMO A/B buttons**  
These buttons are used to enter the A and B points for A–B Repeat.



- ⑨ **CLEAR button**  
This button is used to cancel functions and delete characters in disc and song titles.
- ⑩ **REC SELECT buttons**  
These buttons are used to select tracks for recording.
- ⑪ **MARK SEARCH buttons**  
These buttons are used to locate song markers.
- ⑫ **MARK button**  
This button is used to enter markers during recording or playback.
- ⑬ **LAST REC SEARCH IN/OUT buttons**  
These buttons are used to locate the LAST REC IN and OUT points.
- ⑭ **SONG SEARCH buttons**  
These buttons are used to search for songs.
- ⑮ **Disc Transport buttons**
- REHE**—This button is used to enter Rehearse mode. The REHE indicators flash in Rehearse Pause mode and stay on continuously while rehearsal is in progress.
- REC**—This button is used to enter Record mode. The REC indicators flash in Record Pause mode and stay on continuously while recording is in progress.
- PLAY**—This button is used to start normal playback, start rehearsal, and start recording. It can also be used to cancel rehearsal and recording. In this case, normal playback continues from the point at which the [PLAY] button is pressed. The PLAY indicators light up while playback is in progress and flash when playback is paused.
- PAUSE**—This button is used to pause playback, recording, or rehearsal.
- REVIEW**—This button is used to start review (i.e., review the song at a speed higher than normal playback). One press reviews at 2-times normal speed, while two presses review at 4-times normal speed. The review speed is shown on the display: REV X2 or REV X4. You can toggle between the X2 and X4 review speeds by pressing the [REVIEW] button. Review can be started from stop, pause, or while playback is in progress.
- FF CUE**—This button is used to start FF CUE (i.e., preview the song at a speed higher than normal playback). One press cues at 2-times normal speed, while two presses cue at 4-times normal speed. The cue speed is shown on the display: FF X2 or FF X4. You can toggle between X2 and X4 cue speeds by pressing the [FF CUE] button. FF CUE can be started from stop, pause, or while playback is in progress.
- When using the review or FF CUE function, the time counter may occasionally stop. This is not a fault.
- STOP/TOC WRITE**—This button is used to stop playback, review, cue, rehearsal, and recording. It's also used to write the TOC data to disc when MD4 is stopped.
- ⑯ **ENTER button**  
This button is used to set functions.
- ⑰ **DATA -/+ buttons**  
These buttons are used to set parameters.
- ⑱ **EJECT button**  
This button is used to eject the disc.

*Note:* If you press the EJECT button while TOC EDIT is shown on the display, the disc will not eject. Press [TOC WRITE] to update the TOC, and then eject the disc.

## Topside Connectors

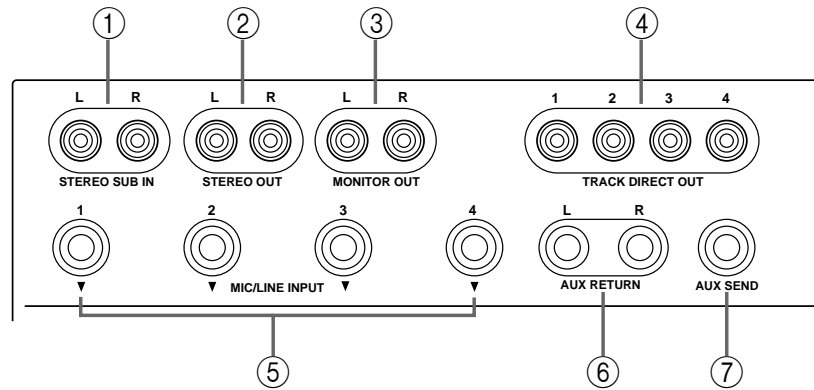

### ① STEREO SUB IN

These phono jacks are used to connect another mixer to MD4 to increase the number of available input channels. The stereo output signals from the other mixer can be mixed into the MD4 stereo mix or recorded to MD4 tracks. Connect them to the other mixer's stereo outputs.

### ② STEREO OUT

These phono jacks are used to connect a stereo master recorder for recording the final mix. The master recorder could be a DAT recorder, MiniDisc recorder, or cassette tape deck. Connect them to your master recorder's stereo inputs.

### ③ MONITOR OUT

These phono jacks are used to send the monitor signals to a stereo monitor amplifier and speakers. This could be a dedicated monitor amplifier and speakers or your hi-fi system. Connect them to the monitor amplifier's stereo inputs. The MONITOR OUT signal is the same as the headphone signal.

### ④ TRACK DIRECT OUTs

These phono jacks are used to send the disc playback signals to another mixer. This is useful when you use MD4 in conjunction with a larger mixer. Connect them to the line inputs on the other mixer. With no disc loaded, the DIRECT OUTs output the group signals.

### ⑤ MIC/LINE INPUTs

These 1/4-inch phono jacks are used to connect microphones, electronic musical instruments, and other line-level sound sources to MD4.

### ⑥ AUX RETURN

These 1/4-inch phono jacks are used to return the processed stereo signals from an external effects processor. The processed signals can then be mixed into the MD4 stereo mix or recorded to tracks. Connect them to the effects processor's stereo outputs.

### ⑦ AUX SEND

This 1/4-inch phono jack is used to send the Aux Send signal to an external effects processor. Connect it to the effects processor's input.

## Front Connectors

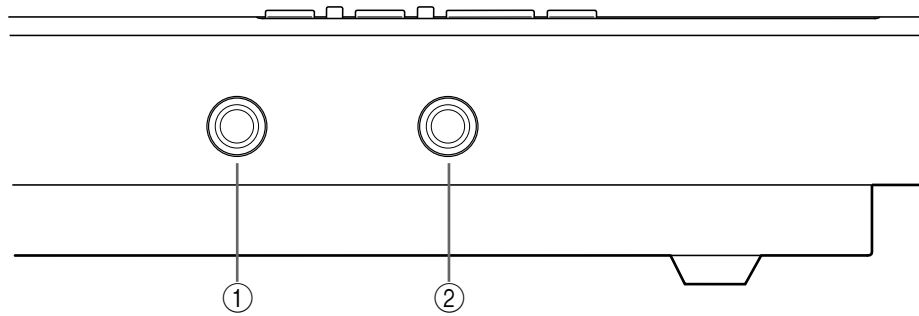

① **PHONES**

A pair of stereo headphones can be connected here for monitoring. The headphone signal is the same as the MONITOR OUT signal.

② **PUNCH I/O**

An optional footswitch, such as the Yamaha FC5, can be connected here for foot-controlled playback, rehearsal, recording, or punch in/out.

## Rear

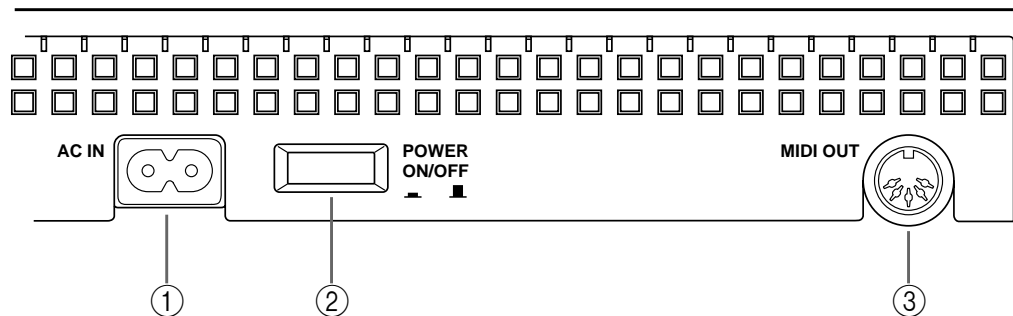

**CAUTION**

TO PREVENT ELECTRIC SHOCK,  
MATCH WIDE BLADE OF PLUG TO  
WIDE SLOT, FULLY INSERT.

① **AC IN**

Connect the supplied power cord here.

② **POWER ON/OFF switch**

This switch is used to turn on and off MD4.

③ **MIDI OUT**

This connector is used to send MTC (MIDI Timecode) or MIDI Clock to a MIDI sequencer for synchronized operation. Connect it to the MTC or MIDI IN connector on your MIDI sequencer.

# 3 The First Session

This chapter explains how to record and mix your first MD4 session. If this is your first time with a multitrack recorder, we recommend that you start with this chapter and follow all the procedures closely. When you've completed this chapter, have a look at subsequent chapters, which explain more advanced MD4 functions and require a basic knowledge of MD4 and multitrack recording techniques.

## Quick-Start System

The following illustration shows the basic equipment necessary to start recording with MD4.

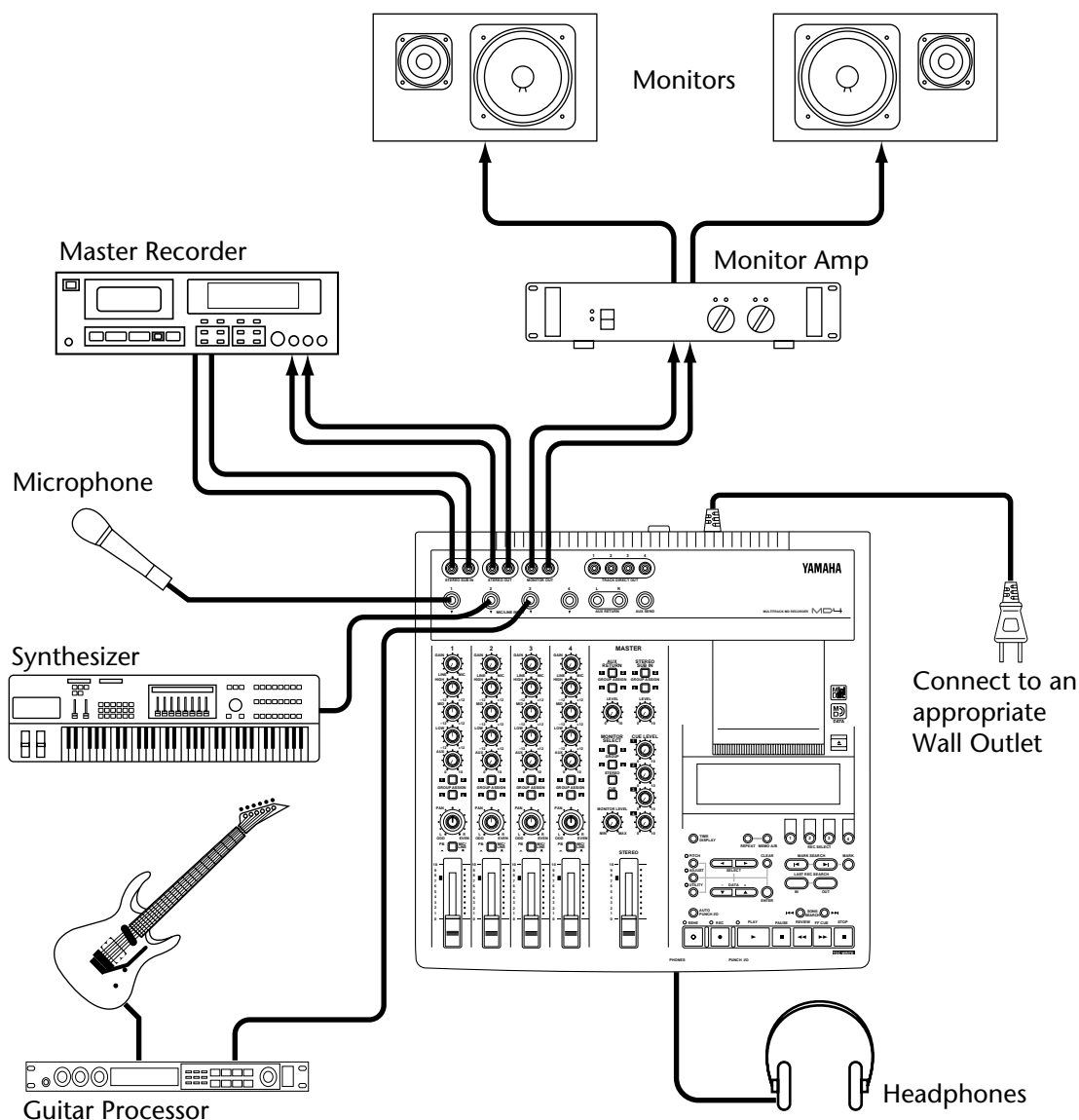

The microphone, synthesizer, and guitar are examples of the kind of sound sources that can be connected to MD4. For monitoring, you can use either headphones or a monitor amp and speakers. Alternatively, you could use your hi-fi amp and speakers. The master recorder is required for mixdown.

## Connecting the Power Cord

1. Connect the supplied power cord to the AC IN socket on the rear of MD4.
2. Plug the other end of the power cord into a suitable AC wall outlet.

## Turning On MD4

1. Press the POWER switch at the rear of MD4. The display lights up.

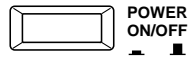

To turn off MD4, press the POWER switch again.

## Loading a Disc

1. Press the EJECT button to open the disc compartment.
2. Insert the disc into the compartment with the arrow pointing forward.  
The disc should slide easily into the compartment and click into place. If it doesn't, make sure you've inserted it the right way around (arrow forward).
3. Close the disc compartment.  
When a disc is loaded, MD4 reads the TOC to see what the disc contains. If it's a new disc, the message `Blank Disc` appears. If the disc contains some songs, the disc title appears for a few seconds and then scrolls off the display. After that, the total number of songs on the disc is shown. For example, `Total 004`

## Recording the First Track





1. Connect a sound source to MIC/LINE INPUT 1.
2. If you connect a line-level source, set the GAIN control to LINE (i.e., fully counterclockwise). If you connect a microphone, set the GAIN control mid-way. The GAIN control is adjusted again later on in this procedure.
3. Set the input selector switch on Input Channel 1 to MIC/LINE.
4. Press the GROUP ASSIGN [1–2] switch on Input Channel 1.  
This assigns the Channel 1 signal to Tracks 1 and 2.

The following table show the relationship between Groups and Tracks.

Assigned to...		Destination Track
Group 1	→	Track 1
Group 2	→	Track 2
Group 3	→	Track 3
Group 4	→	Track 4

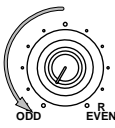
5. Turn the PAN control to L/ODD.  
This sends the signal to just Track 1.

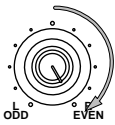
The following table show the relationship between the PAN control and Group/Tracks.

GROUP ASSIGN	PAN	Destination Group/Track
		Group/Track 1
		Group/Track 3
		Group/Track 2
		Group/Track 4

6. **Press the MONITOR SELECT [1–3] switch.**  
This sets the monitor source to Track 1.
7. **Set the MONITOR LEVEL control midway.**
8. **Raise Channel 1 fader to the 7–8 mark.**  
You should now be able to hear the sound source. If you don't hear anything, recheck the preceding steps.
9. **Press REC SELECT button [1].**  
A circle flashes around track indicator 1.
10. **Press the [REC] button.**  
The REC indicators flash, indicating Record Pause mode. Track 1 meter shows the signal level.
11. **Adjust the GAIN control on Channel 1 so that the loudest sounds cause the meter to reach the –3 position. If the meter goes beyond the –3 position into CLIP, back off the GAIN control a little.**  
It is important that you set this level correctly to achieve the best sound. Too low a level does not make full use of the sonic capabilities of your MD4. Too high a level may cause distortion.  

*Tip:* If the level of the sound source varies greatly, making it difficult to find an optimum setting for the GAIN control, you can use an external compressor to even out the signal level.
12. **Press the [PLAY] button to start recording.**  
Recording starts and the time counter shows the recording time.
13. **Press the [STOP] button to stop recording.**  
You've now recorded your first track.

## Listening to the First Track

1. **Press the LAST REC SEARCH [IN] button.**  
This returns to the point at which recording started. For the first recording, this is always 00:00.00.

2. Press the MONITOR SELECT [1–3] switch.
3. Press the [CUE] MONITOR SELECT switch.
4. Set CUE LEVEL 1 midway.
5. Press the [PLAY] button to start playback.  
You should now be able to hear what was recorded. Adjust CUE LEVEL 1 as required. If you don't hear anything, recheck the preceding steps.

## Overdubbing

Overdubbing is the technique used to record new sounds to empty tracks while listening to the sounds already recorded on other tracks. The following overdubbing procedure can be used to record on Tracks 2, 3, and 4.

1. On the input channel previously used for recording, set the fader to zero and set the GROUP ASSIGN switches to OFF.
  2. Press the [REC SELECT] button of the track previously recorded so that track is not overwritten.  
The flashing circle around the track indicator disappears.
  3. Press the LAST REC SEARCH [IN] button.  
This returns to the point at which recording started.
  4. Connect a sound source to MIC/LINE INPUT 2, 3, or 4.
  5. If you connect a line-level source, set the GAIN control to LINE (i.e., fully counterclockwise). If you connect a microphone, set the GAIN control midway. The GAIN control is adjusted again later on in this procedure.
  6. Press the [GROUP ASSIGN] switch on the Channel being used.  
Select Group 2, 3, or 4. We've already recorded onto Track 1, so we cannot use Group 1.
  7. Use the PAN control to assign the signal to odd or even numbered group.
  8. Press the [GROUP] MONITOR SELECT switch for the group being used.  
This sets the monitor source to the track that will be recorded.
  9. Raise the Channel fader to the 7–8 mark.  
You should now be able to hear the sound source.
  10. Press the [REC SELECT] button of the track that you want to record.  
A circle around the number of the selected track flashes.
  11. Press the [REC] button.  
The REC indicators flash, indicating Record Pause mode. The track meter shows the signal level.
- Note:* You could press the [REHE] button instead to rehearse the overdub.
12. Adjust the GAIN control on the input channel so that the loudest sounds cause the meter to reach the –3 position. If the meter goes beyond the –3 position into CLIP, back off the GAIN control a little.
  13. Press the [PLAY] button to start recording (or Rehearsal).  
Recording (or Rehearsal) starts and the time counter shows the recording time.
  14. Use the CUE LEVEL controls corresponding to previously recorded tracks to balance the levels between what was previously recorded on other tracks

and what you are recording now.

15. **Press the [STOP] button to stop recording (or Rehearsal).**
16. **Press the LAST REC SEARCH [IN] button.**

This returns to the point at which recording (or Rehearsal) started.
17. **Press the [PLAY] button to play back what you've recorded.**

If you just rehearsed the overdub, there won't be anything to play back yet.
18. **Use the CUE level controls to adjust the monitor level of each track.**

Repeat this procedure until you've recorded all tracks. Then you're ready for mixdown.

## Mixdown

Mixdown is the final technique in multitrack recording. Here you mix the sounds from all four tracks, with EQ and effects, into a balanced stereo mix and record it to a stereo master recorder, such as a DAT, MiniDisc, or cassette tape machine.

1. **Make sure that all [GROUP ASSIGN] switches are off, including the MONITOR SELECT [GROUP] switches.**
2. **Set the input select switch on each input channel to PB.**
3. **Set the PAN control on each input channel to its center position.**
4. **Set the fader on each input channel and the STEREO fader to the 7–8 mark.**
5. **Press the MONITOR SELECT [STEREO] switch and set the MONITOR LEVEL control midway.**
6. **Use the Song Search buttons to locate the start of the song.**

If the LAST REC IN point is still 00:00, you can use the LAST REC SEARCH [IN] button. Alternatively, you can use the MARK SEARCH buttons.
7. **Press the [PLAY] button to start playback.**

You should now be able to hear all four tracks playback. If you don't hear anything, recheck the preceding steps.
8. **Mix and refine your music as follows:**
  - Balancing Levels**—Use the input channel faders to balance the levels of the four tracks.
  - Pan**—Use the PAN controls to position sounds between the left and right speakers.
  - EQ**—Use the three-band EQ to shape the tone of each track.
  - Applying Effects**—Use the AUX SEND and AUX RETURN functions to patch in an external effects processor. See *Applying Effects* on page 34 for more information.

See *Mixdown* on page 63 for a more detailed look at mixdown techniques.
9. **Record the Final Mix to your stereo master recorder.**

That's it! You've completed your first session with MD4.



---

# An Overview of Multitrack Recording

This section describes the fundamental principles of multitrack recording.

## Basic Multitracking

**Monitoring**—This is the process of listening to a sound as it's being recorded or listening to recorded sounds as new sounds are recorded to other tracks. See *About Monitoring* on page 18 for more information.

**Recording the First Track**—The first track to be recorded is typically the drum track. A drum track that starts before other instruments makes a good timing and count-in reference. If your song starts with several instruments on the first bar, you may find it helpful to record a temporary count-in on another track, which can be erased later. See *Recording the First Track* on page 13 for more information.

**Overdubbing**—This is the technique of recording new sounds to empty tracks while listening to the sounds that you've already recorded on the other tracks. Essentially, songs are recorded track-by-track. This technique is used for most modern studio recording. See *Overdubbing* on page 15 for more information.

**Mixdown**—This is the final technique in multitrack recording. Here you mix the sounds from all four tracks, with EQ and effects, into a balanced stereo mix and record it to a stereo master recorder, such as a DAT, MiniDisc, or cassette tape machine. See *Mixdown* on page 16 for more information.

## Advanced Multitracking

**One-Take Recording**—With this technique, all tracks are recorded in one take. This is useful for live recording and recording bands that like to record with all members playing together. Punch in/out and ping-pong techniques can be used after the one-take recording to add and correct sections. See *One-Take Recording* on page 57 for more information.

**Punch In/Out**—This technique allows you to rerecord specific sections of a track. It's often used to rerecord a not so perfect guitar solo or vocal phrase. Punch in/out can be rehearsed before actually recording to disc. Punch in/out on MD4 can be performed manually or automatically, which is useful when you are playing or singing and operating MD4 all at the same time. See *Manual Punch In/Out* on page 21 for more information.

**Ping-Pong**—This technique allows you to mix and record several tracks onto another track. This is often used to free up tracks for more recording. So although MD4 is a four-track recorder, you can record more than just four tracks using the ping-pong technique. You can also combine ping-pong with overdub recording. For example, Tracks 1 and 2 are mixed and recorded onto Track 4 along with a new signal coming from Input Channel 3. Ping-pong can be rehearsed before actually recording to disc. See *Ping-Pong Recording* on page 29 for more information.

**Synchronization**—This technique enables MD4 and a MIDI sequencer to work together as a unified recording tool: MD4 for acoustic sounds and MIDI sequencer for MIDI instrument sounds. See *MD4 & MIDI* on page 49 for more information.

## About Monitoring

MD4 features a flexible monitoring system, allowing you to monitor signals at various points. You can monitor sounds through a pair of stereo headphones connected to the PHONES jack, or through a monitor amplifier and speakers connected to the MONITOR OUT jacks. The MONITOR SELECT switches are used to select the monitor source, and the MONITOR LEVEL control is used to adjust the level.

**GROUP**—These switches select the Group buses as the monitor source. This allows you to monitor signals that are assigned from input channels, AUX RETURN, or the STEREO SUB IN to tracks for recording. Use these switches to monitor what will be recorded. For example, if you're recording the sounds from three input channels to one track simultaneously, you'll need to listen to a mix of the three sounds in order to balance the levels correctly. You can do this using the GROUP switches.

When only the [1–3] or [2–4] MONITOR SELECT GROUP switch is pressed, the monitor signal is set as mono. This ensures that the signal being monitored appears in both the left and right monitor speakers. So even when you monitor a single group signal, it will be heard through both speakers. When both the [1–3] and [2–4] MONITOR SELECT GROUP switches are pressed, however, the monitor signal is set as stereo. So you can monitor stereo signals on Groups 1 and 2 or Groups 3 and 4.

**STEREO**—This switch selects the Stereo bus as the monitor source. This allows you to monitor the STEREO OUT signals and is typically used during mixdown. It can also be used to monitor signals that are not going to be recorded by MD4, such as a MIDI tone generator that is controlled by a MIDI sequencer. In this case, the tone generator is only monitored while other sounds are recorded on MD4. Then for the final mixdown, the tone generator sounds are mixed with the sounds recorded on MD4 and mixed down to a stereo master recorder.

**CUE**—This switch selects the CUE bus as the monitor source. This allows you to monitor track signals. Unlike the other monitor sources, the CUE monitor source changes when MD4 starts recording or rehearsing. For example, during normal playback CUE allows you to monitor the sounds recorded on disc. Obviously, if nothing is recorded, there's nothing to monitor. When either record or rehearse is started, however, CUE allows you to monitor the sounds that are assigned to tracks for recording. The application of this may not appear very obvious at the moment, but all will become clear in the punch in/out and ping-pong recording sections.

*Note:* Although you can monitor GROUP, STEREO, and CUE all at the same time, there is a possibility that you'll monitor the same signal from two different points in the signal flow. At first, you may find it less confusing to select just one monitor source at a time.

# 4 Recording & Mixing Techniques

This chapter explains MD4 recording and mixing techniques.

## Recording a New Song

The NEW REC function is used to record new songs on a disc. Songs are recorded sequentially, as shown below. With a blank disc, simply pressing the [REC] button engages New Record mode. For a disc that already contains some songs, however, you must first locate the Blank Top area of the disc, as explained below.

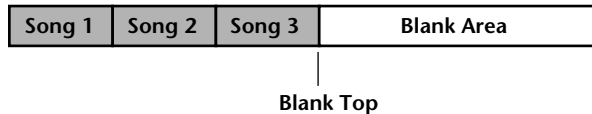

## Searching for the Blank Top

“Blank Top” is the top part of the largest unrecorded area on a disc. To locate the Blank Top, press the [▶▶] button repeatedly until BLANK TOP appears on the display. When the BLANK TOP is located, MD4 is ready to record a new song.

Since nothing is recorded at the BLANK TOP, you cannot use the Play, Review, and FF CUE functions. Press the [◀◀] SONG SEARCH button if you want to return to the previous song.

So long as a blank area exists on a disc, recording beyond the end of a song is possible. This means that songs can be made longer. At the point where recording continues into the blank area, NEW REC appears on the display. For punch in/out recording, you can select the REMAIN Time Counter mode to check how much recording time, including the blank area, is available. For rehearsal, MD4 always stops at the end of a song.

If you have erased a song that was in between other songs, there will be a new blank area on the disc. Searching for the Blank Top will locate the Blank Top, that is the top position of the largest blank area, which will be used to record the new song. The REMAIN time will be shown automatically.

If you record over an existing song, the total recording time will be the same as the total time of the song being overwritten. If the next existing song is erased, however, the total time for the new recording will be the sum of both songs. For example, Song 1 is three minutes and Song 2 is two minutes. Erasing Song 2 provides a total time of 5 minutes for the new recording.

## Setting the Recording Mode

The following table shows the three MD4 Recording modes. Songs on the same disc can be recorded in different modes, but you cannot change the mode while recording. These modes allow you to use disc space efficiently. Audio quality is the same for all three modes.

Rec Mode	Tracks Used	Recording Time (minutes)	MD DATA Disc	MiniDisc
4TR	1, 2, 3, 4	37	O	X
2TR	1, 2	74	O	O
MONO	1	148	O	O

Normal MiniDisc decks cannot play MD4 MD DATA discs. They can, however, play MiniDiscs containing 2TR and MONO mode songs. When a recordable MiniDisc is loaded into MD4, the 2TR Recording mode is selected automatically. For subsequent 4-track recording onto an MD DATA disc, set the Recording mode to 4TR. The Recording mode setting is not stored when MD4 is turned off, and it always defaults to 4TR when it's turned on.

1. To set the Recording mode, press the [UTILITY] button and use the [◀] and [▶] SELECT buttons to select the Rec Mode function.
2. Press the [ENTER] button.  
The display shows 4TR 2TR MONO
3. Use the [◀] and [▶] SELECT buttons to select a Recording mode.  
Only the 2TR and MONO modes can be selected when a MiniDisc is loaded.
4. Press the [UTILITY] button to exit the Rec Mode function.

## Recording

1. Press the [REC] button to engage Record Pause mode.  
The display shows the number of the new song and NEW REC. This is Record Pause mode.  
Initially, all tracks that can be recorded in the current Recording mode are selected, as shown by the flashing circles around the track indicators. You cannot deselect all tracks for a new recording. At least one track is always selected.
2. Use the REC SELECT buttons to select tracks for recording.  
You can check the available recording time using the REMAIN Time Counter mode. Press the [TIME DISPLAY] button repeatedly until REMAIN appears on the display.
3. Press the [PLAY] button to start recording.  
Recording starts and the Time Counter starts counting.
4. When you've finished, press the [STOP] button.  
Recording stops. Recording stops automatically when all available disc space is used up.
5. Press the [TOC WRITE] button to update the TOC.  
The TOC is updated.

## Titling Discs & Songs

When a disc with a title is first loaded into MD4, the title appears on the display for a few seconds and then scrolls off to the left. When a song with a title is selected, the title appears on the display next to the song number. Titles make it easy to identify discs and songs.

1. Press the [UTILITY] button and use the [◀] and [▶] SELECT buttons to select the Text function.
2. Press the [ENTER] button.
3. Use the [-] and [+] DATA buttons to select the disc title (DSC) or a song.
4. Press the [▶] SELECT button.
5. Use the [-] and [+] DATA buttons to set characters and the [◀] and [▶] SELECT buttons to position the cursor within the title.

The following characters are available.

```

ABCDEFGHIJKLMN OPQRSTUVWXYZ
abcdefghijklmnopqrstuvwxyz
()<>!;:*+-=/' , . " ` % & ! ? #
0123456789

```

Spaces are available between character rows. Use the [CLEAR] button to delete characters.

6. When you've finished, press the [TOC WRITE] button to update the TOC.

## Manual Punch In/Out

Punch in/out techniques allows you to rerecord specific sections of a track. This can be used to correct mistakes or record something new into silent sections of a track. If you're operating MD4 and playing or singing the part to be recorded, you'll find it much easier to use the Auto Punch In/Out function, which performs the punch in/out automatically. See *Auto Punch In/Out* on page 24 for more information.

Manual punch in/out can be performed in three different ways: 1) using the [REC] button. 2) using the individual [REC SELECT] buttons. 3) using an optional footswitch. The Rehearsal function can be used with all three methods.

### Using the REC Button

- 1. Locate to a position before the point at which you want to punch in.**
- 2. Press the [REC SELECT] button of the track that you want to record.**  
A circle flashes around the corresponding track indicator.
- 3. Press the [PLAY] button to start playback.**  
Playback starts and the PLAY indicators light up.
- 4. At the point where you want to punch in, press the [REC] button.**  
Recording starts. The REC indicators light up. The circle around the track indicator stops flashing and lights up continuously. And the LAST REC IN indicator lights up, indicating that the IN point has been stored.  
  
If you're monitoring the track via CUE, you'll hear the existing sound playback until the [REC] button is pressed. After which you'll hear the new sound that's being recorded.  
  
Instead of pressing the [REC] button you could have pressed the [REHE] button to engage Rehearse mode. Rehearse allows you to have a dry run before actually recording. In Rehearse mode, the REHE indicators light up, not the REC indicators.
- 5. At the point where you want to punch out, press the [PLAY] button.**  
Recording stops. The REC indicators go off. The circle around the track indicator flashes. And the LAST REC OUT indicator lights up, indicating that the OUT point has been stored.  
  
Through the CUE monitor you'll hear the existing sound playback.
- 6. Press the [STOP] button to stop playback.**  
The following illustration shows how punch in/out works with the [REC] button.

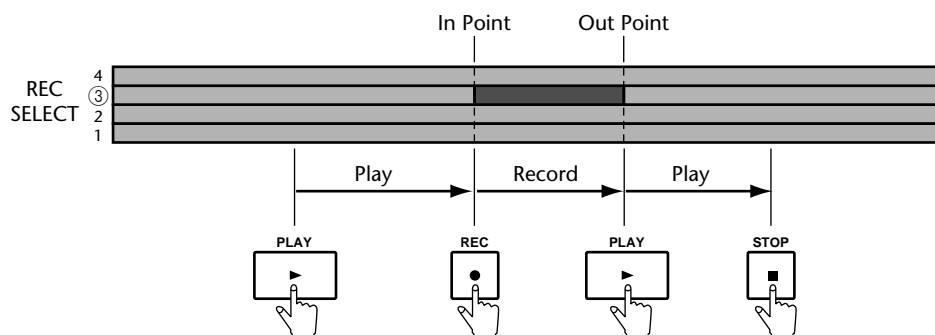

## Using the REC SELECT buttons

1. **Locate to a position before the point at which you want to punch in.**
2. **Make sure that all track indicators are off (i.e., no tracks selected).**
3. **Press the [REC] button.**

The REC indicators flash, indicating Record Pause mode is engaged.

Instead of pressing the [REC] button you could have pressed the [REHE] button to engage Rehearse Pause mode. Rehearse allows you to have a dry run before actually recording. The rest of this procedure can be used with the Rehearsal function. Instead of the REC indicators, however, the REHE indicators are used.

4. **Press the [PLAY] button to start playback.**

Playback starts and the PLAY indicators light up. The REC indicators continue to flash, indicating Play Record Wait mode.

5. **At the point where you want to punch in, press a [REC SELECT] button.**

Recording starts. The REC indicators stop flashing and light up continuously. A circle appears around the corresponding track indicator. And the LAST REC IN indicator lights up, indicating that the IN point has been stored.

If you're monitoring the track via CUE, you'll hear the existing sounds playback until the [REC SELECT] button is pressed. After which you'll hear the new sound that's being recorded.

6. **At the point where you want to punch out, press the [PLAY] button.**

Recording stops. The REC indicators go off. The circle around the track indicator flashes. And the LAST REC OUT indicator lights up, indicating that the OUT point has been stored.

Through the CUE monitor you'll hear the existing sounds playback.

Instead of pressing the [PLAY] button you could have pressed the [REC SELECT] button to punch out. In this case MD4 remains in Play Record Wait mode, so you can punch in again using the [REC SELECT] buttons.

7. **Press the [STOP] button to stop playback.**

The following illustration shows how punch in/out works with the [REC SELECT] buttons.

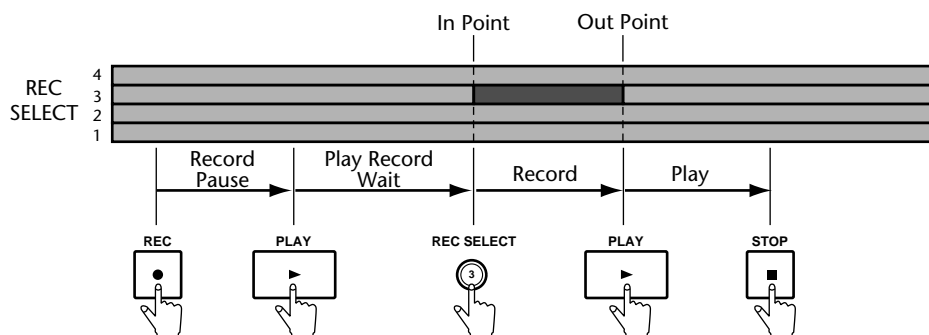

## Using a Footswitch

1. **Connect an optional footswitch to the PUNCH I/O jack.**
2. **Locate to a position before the point at which you want to punch in.**
3. **Press the [REC SELECT] button of the track that you want to record.**  
A circle flashes around the corresponding track indicator.
4. **Press the [REC] button.**  
The REC indicators flash, indicating Record Pause mode is engaged.
5. **Press the footswitch to start playback.**  
Playback starts and the PLAY indicators light up. The REC indicators continue to flash.
6. **At the point where you want to punch in, press the footswitch again.**  
Recording starts. The REC indicators light up. The circle around the track indicator stops flashing and lights up continuously. And the LAST REC IN indicator lights up, indicating that the IN point has been stored.  
  
If you're monitoring the track via CUE, you'll hear the existing sounds playback until the footswitch is pressed. After which you'll hear the new sound that's being recorded.
7. **At the point where you want to punch out, press the footswitch again.**  
Recording stops. The REC indicators go off. The circle around the track indicator flashes. And the LAST REC OUT indicator lights up, indicating that the OUT point has been stored.  
  
Through the CUE monitor you'll hear the existing sounds playback.
8. **Press the footswitch again to enter Pause mode.**
9. **Press the [STOP] button to finish.**  
The following illustration shows how punch in/out works with a footswitch.

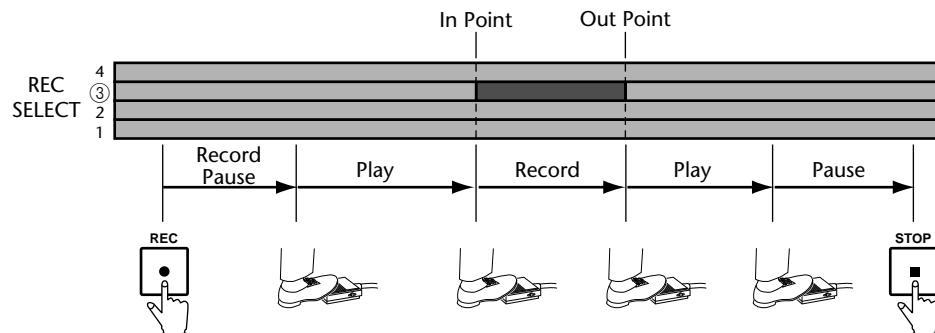

A footswitch can also be used to control other MD4 functions. See *Using a Footswitch* on page 33 for more information.

## Auto Punch In/Out

The Auto Punch In/Out function automates the punch in/out procedure, allowing you to concentrate on your playing or singing. Auto Punch In/Out uses the LAST REC IN and OUT points as the punch in and punch out points. So you must set these points first. Once set, you can rehearse the punch in/out repeatedly with accuracy.

### Setting the In/Out Points “On-the-Fly”

1. **Locate to a position before the point at which you want to punch in.**
2. **Press the [REC SELECT] button of the track that you want to record.**  
A circle flashes around the corresponding track indicator.
3. **Press the [PLAY] button to start playback.**  
Playback starts and the PLAY indicators light up.
4. **At the point where you want to set the IN point, press the [REHE] button.**  
The IN indicator appears, indicating that the IN point has been set, and the REHE indicators light up. Playback continues.
5. **At the point where you want to set the OUT point, press the [PLAY] button.**  
The OUT indicator appears, indicating that the OUT point has been set, and the REHE indicators go out. Playback continues.
6. **Press the [STOP] button to stop playback.**  
The following illustration shows how the IN and OUT points are set.

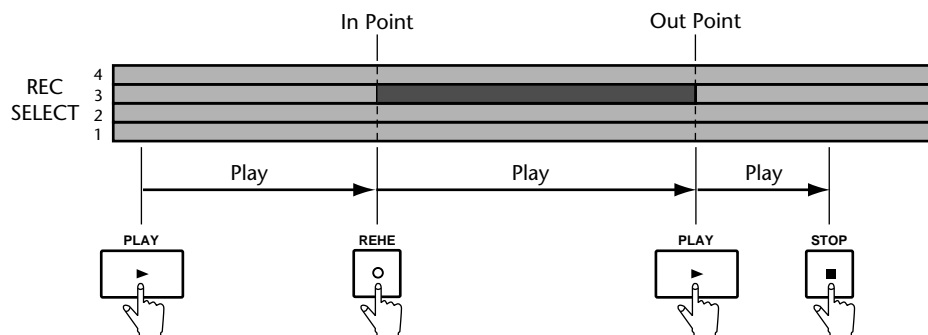

The positions of the LAST REC IN and OUT points can be adjusted manually using the Adjust function. See *Adjusting Markers* on page 38 for more information.

### Another Way to Set the IN/OUT Points

The IN and OUT points can also be set when MD4 is stopped or paused by holding down the LAST REC SEARCH [IN] or LAST REC SEARCH [OUT] button, respectively, until *Stored* appears on the display. Normally during playback, MD4 locates to the IN or OUT point when these buttons are pressed.

The above procedures can also be used to set the IN and OUT points for use with the Off Line Punch function. See *Track-to-Track Copy* on page 47 for more information.



## Rehearsing Auto Punch

1. Press the [REC SELECT] button of the track that you want to record.

A circle flashes around the corresponding track indicator.

2. Press the [AUTO PUNCH I/O] button.

The Pre-Roll point is located automatically and the PRE indicator flashes. The REHE indicators flash and the display shows A. PUNCH REHE. The AUTO PUNCH and POST indicators appear. This is Auto Punch Rehearse Standby mode.

If you're monitoring the track via CUE, you'll hear the signal that is assigned to the selected track.

If you want to rehearse the Auto Punch In/Out repeatedly, press the [REPEAT] button. REPEAT appears on the display.

3. Press the [PLAY] button to start the Auto Punch In/Out sequence.

Playback starts and the PLAY indicators light up. The REHE indicators continues to flash, indicating Play Rehearse Wait mode.

At the specified IN point, punch in occurs (i.e., rehearsal starts). The REHE indicators stop flashing and lights up continuously. The IN indicator disappears.

If you're monitoring the track via CUE, you'll hear the existing sounds playback until the IN point. After which you'll hear the new sound that's being recorded.

At the specified OUT point, punch out occurs (i.e., rehearsal stops). The REHE indicators go out and the OUT indicator disappears.

Playback continues up to the Post-Roll point. Then the Pre-Roll point is located automatically, and MD4 waits in Auto Punch Rehearse Standby mode. You can press the [PLAY] button again for another rehearsal or move on to the next section to perform the Auto Punch In/Out for real.

If you pressed the [REPEAT] button in Step 2, MD4 will rehearse the Auto Punch In/Out repeatedly until you press the [STOP] button.

The following illustration shows the Auto Punch Rehearse sequence.

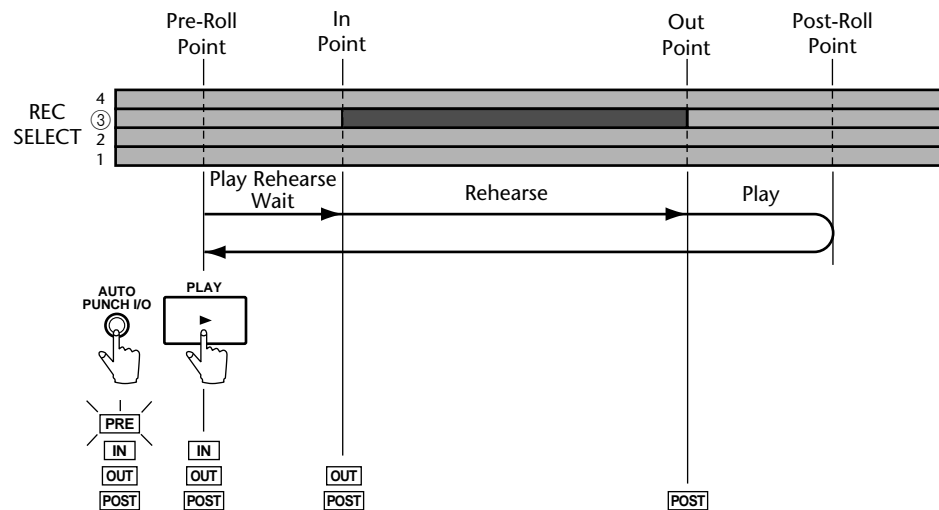

## Performing Auto Punch for Real

1. Press the [REC SELECT] button of the track that you want to record.

A circle flashes around the corresponding track indicator.

2. Press the [AUTO PUNCH I/O] button.

The Pre-Roll point is located automatically and the PRE indicator flashes. The REHE indicators flash and the display shows **A. PUNCH REHE**. The AUTO PUNCH and POST indicators appear. This is Auto Punch Rehearse Standby mode.

3. Press the [REC] button.

The REC indicators flash and the display shows **A. PUNCH**. This is Auto Punch Record Standby mode.

If you're monitoring the track via CUE, you'll hear the signal that is assigned to the selected track.

4. Press the [PLAY] button to start the Auto Punch In/Out sequence.

Playback starts and the PLAY indicators light up. The REC indicators continue to flash, indicating Play Record Wait mode.

At the specified IN point, punch in occurs (i.e., recording starts). The REC indicators stop flashing and light up continuously. The IN indicator disappears.

If you're monitoring the track via CUE, you'll hear the existing sounds playback until the IN point. After which you'll hear the new sound that's being recorded.

At the specified OUT point, punch out occurs (i.e., recording stops). The REC indicators go out and the OUT indicator disappears.

Playback continues up to the Post-Roll point. Then the Pre-Roll point is located automatically, and MD4 waits in Play Pause mode. Press the [PLAY] button to audition the punch in/out.

The following illustration shows the Auto Punch Record sequence.

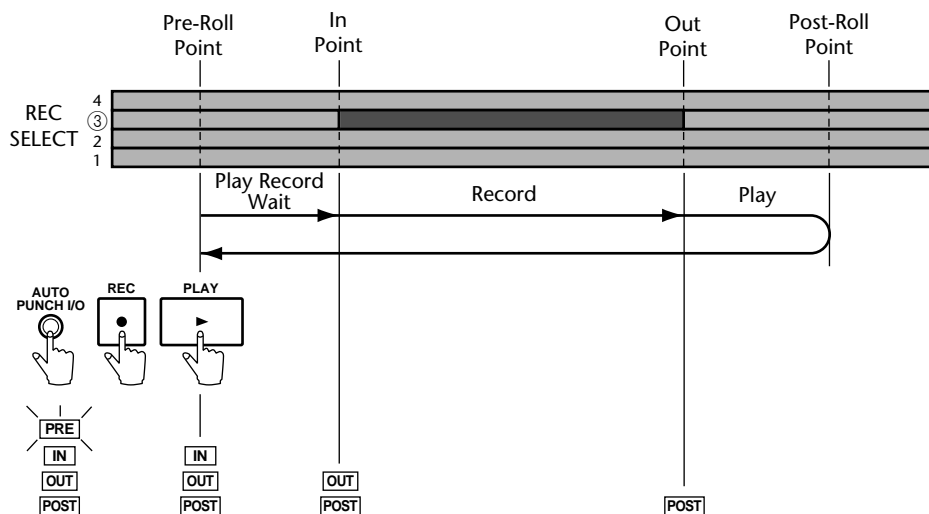

## Auto Punch with a Footswitch

An optional footswitch can be used to start the Auto Punch In/Out sequence.

1. **Press the [REC SELECT] button of the track that you want to record.**

A circle flashes around the corresponding track indicator.

2. **Press the [AUTO PUNCH I/O] button.**

The Pre-Roll point is located automatically and the PRE indicator flashes. The REHE indicators flash and the display shows **A. PUNCH REHE**. The AUTO PUNCH and POST indicators appear. This is Auto Punch Rehearse Standby mode.

3. **Press the [REC] button.**

The REC indicators flash and the display shows **A. PUNCH**. This is Auto Punch Record Standby mode.

4. **Press the footswitch to start the Auto Punch In/Out sequence.**

Playback starts and the PLAY indicators light up. The REC indicators continue to flash, indicating Play Record Wait mode.

At the specified IN point, punch in occurs (i.e., recording starts). The REC indicators stop flashing and light up continuously. The IN indicator disappears.

If you're monitoring the track via CUE, you'll hear the existing sounds playback until the IN point. After which you'll hear the new sound that's being recorded.

At the specified OUT point, punch out occurs (i.e., recording stops). The REC indicators go out and the OUT indicator disappears.

Playback continues up to the Post-Roll point. Then the Pre-Roll point is located automatically, and MD4 waits in Play Pause mode. Press the [PLAY] button to audition the punch in/out.

The following illustration shows the Auto Punch Record sequence with a footswitch.

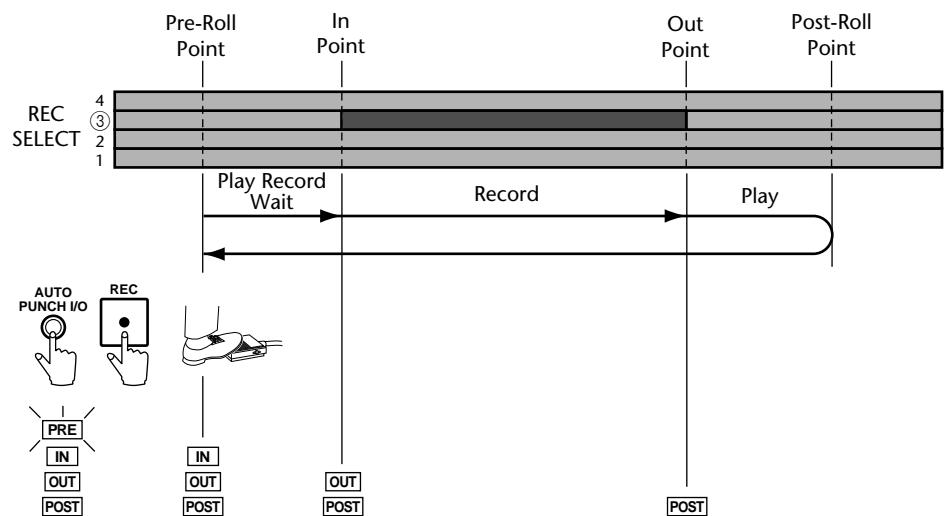

## Setting the Pre-Roll & Post-Roll Times

Pre-Roll and Post-Roll are used in conjunction with the Auto Punch In/Out function. Pre-Roll refers to the time before the IN point at which playback starts. Post-Roll refers to the time after the OUT point at which playback stops. The default time for both Pre-Roll and Post-Roll is 5 seconds. You can change the values independently using the PrePost Roll function, as explained below. These settings are not stored when MD4 is turned off.

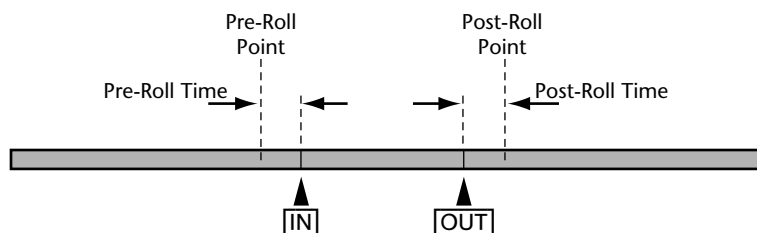

1. Press the [UTILITY] button and use the [◀] and [▶] SELECT buttons to select the PrePost Roll function.
2. Press the [ENTER] button.  
The display shows Pre 5sec
3. Use the [-] and [+] DATA buttons to set the Pre-Roll time from 0 to 9 seconds.
4. Press the [ENTER] button.  
The display shows Post 5sec
5. Use the [-] and [+] DATA buttons to set the Post-Roll time from 0 to 9 seconds.
6. Press the [UTILITY] button to finish.

## Ping-Pong Recording

The ping-pong recording technique (also known as bounce down) is used to free up tracks for further recording. This is accomplished by bouncing down (i.e., mixing and recording) one or two existing tracks to an unused track. Those tracks are then used for further recording. Although MD4 is a four-track recorder, effectively you can record more than just four tracks using this technique. The only drawback is that once several tracks have been bounced, you cannot adjust the individual sounds. You can, however, balance the levels and apply EQ and effects during the actual ping-pong operation. The following illustration shows the ping-pong technique.

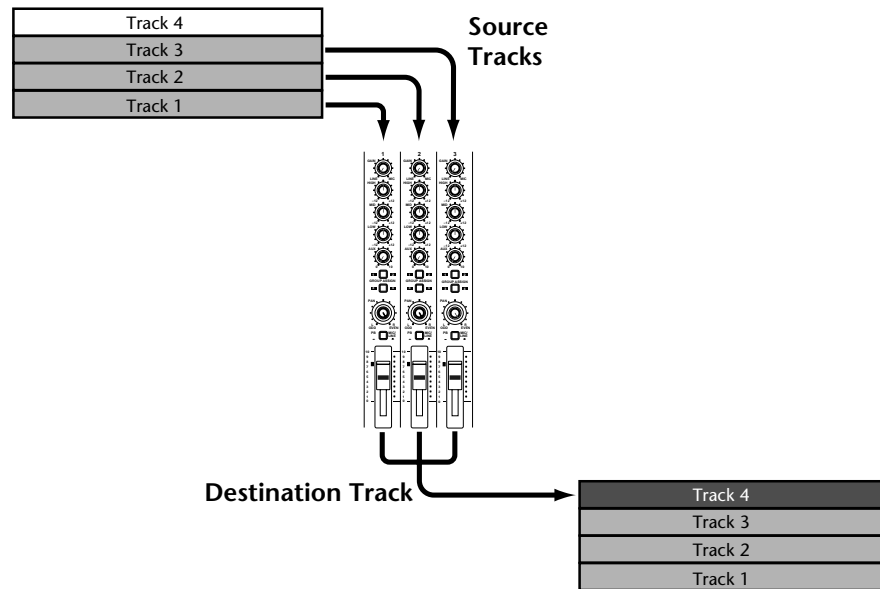

Tape-based multitrackers always need at least one unused track for ping-pong operations. MD4, however, provides four-track playback with ping-pong. So you can record on all four tracks and then bounce them down to one of those tracks. This is possible because MD4 is able to read audio data from a track before writing new audio data to it. When the ping-pong operation is complete of course, the previous audio data in that track is lost. However, you can rehearse ping-pong operations. The following illustration shows four-track playback with ping-pong.

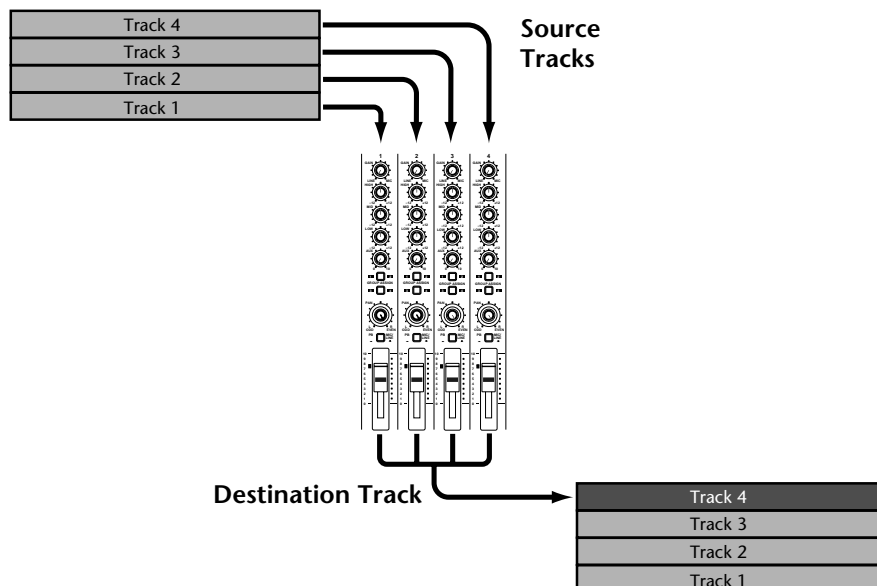

## Preparing for Ping-Pong

1. **Press the [I◀◀] SONG SEARCH button to locate the beginning of the song.**
2. **Set the input select switches on the source track channels to PB.**  
This sets the disc playback signal as the source for the channels.
3. **Set the faders on the source channels to the 7–8 mark.**
4. **Use the ASSIGN switches and PAN controls on the source track channels to assign the signals to the destination track.**  
See *Recording the First Track* on page 13 for information about using the ASSIGN switches and PAN controls to assign signals to tracks.
5. **Press the [REC SELECT] button of the destination track.**  
A circle flashes around the corresponding track indicator.
6. **Press the MONITOR SELECT [GROUP] switch for the destination track.**  
This sets the monitor source to the destination track.
7. **Set the MONITOR LEVEL control as required.**

## Rehearsing the Ping-Pong

8. **Press the [REHE] button.**  
The REHE indicators flash.
9. **Press the [PLAY] button to start the rehearsal.**  
The rehearsal starts and the PLAY indicators light up. The REHE indicators stop flashing and light up continuously.  
You should now be able to hear the source tracks combined.
10. **Use the faders to balance the source track levels and apply EQ as required.**  
To monitor individual tracks, press the MONITOR SELECT [CUE] button and use the individual CUE LEVEL controls.  
Repeat the ping-pong rehearsal until you are satisfied with the combined sound.

## Performing the Ping-Pong for Real

11. **Press the [I◀◀] SONG SEARCH button to locate the beginning of the song.**
12. **Press the [REC] button.**  
The REC indicators flash.
13. **Press the [PLAY] button to start recording.**  
The ping-pong operation starts and the PLAY indicators light up. The REC indicators stop flashing and light up continuously.
14. **When the song has finished, press the [STOP] button.**

## Checking the Ping-Pong Operation

15. Press the [I<<<] SONG SEARCH button to locate the beginning of the song.
16. Press the MONITOR SELECT [GROUP] switch that you pressed previously to monitor the destination track.
17. Press the MONITOR SELECT CUE switch.
18. Set the CUE LEVEL control corresponding to the destination track to mid-way.
19. Press the [PLAY] button to start playback.  
You should now be able to hear the new combined track.

## Ping-Pong with Overdub

The ping-pong technique can be combined with overdub recording. This allows you to bounce down tracks and record a new sound source simultaneously. In the following illustration, for example, Tracks 1, 2, and 3 are bounced to Track 4 along with a new signal coming from Input Channel 4.

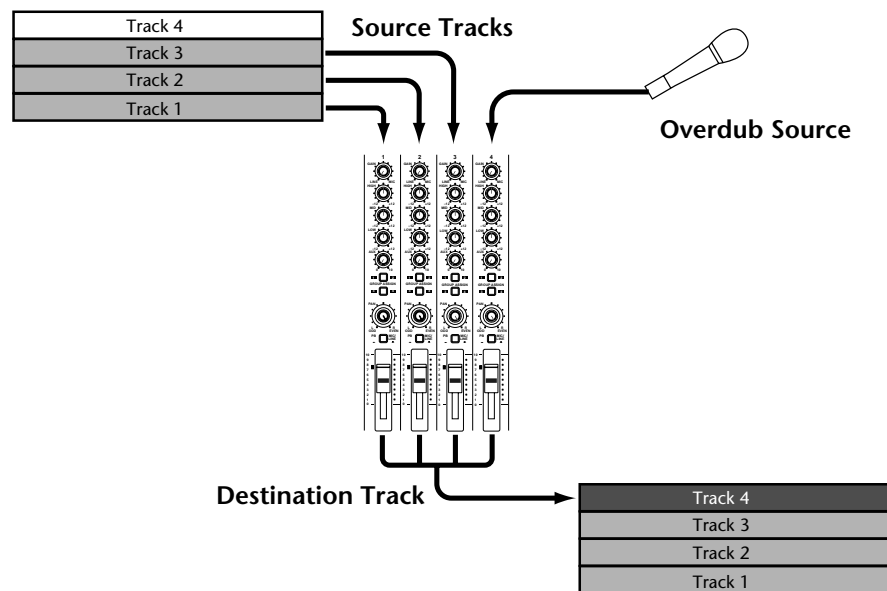

1. Connect a sound source to an unused input channel (i.e., one that's not used with an existing source track).
2. Set the GAIN control as appropriate.
3. Set the input select switch to MIC/LINE.
4. Set the fader to the 7–8 mark.
5. Use the ASSIGN switches and PAN control to assign the signal to the destination track.
6. Continue with *Preparing for Ping-Pong* on page 30.  
During rehearsal, balance the level of the new source with the existing tracks.

## Pitch

The Pitch function allows you to adjust the pitch for playback and recording. The pitch can be adjusted approximately  $\pm 6\%$ . Normally, the Pitch function should be set to Fix, which means the pitch is fixed for normal operation.

See *Pitch* on page 62 for some advanced applications of the Pitch function.

When normal pitch is selected, PITCH FIX is shown on the display. When variable pitch is selected, PITCH VARI is shown.

### Adjusting the Pitch

**1. Press the [PITCH] button.**

The display shows Fix +00.00%

**2. Press the [▶] SELECT button to select VARI.**

VARI appears on the display.

**3. Use the [-] and [+] DATA buttons to adjust the pitch.**

To set the pitch to 0.0%, press the [CLEAR] button.

**4. When you've finished, press the [PITCH] button.**

Playback and recording is now performed at the specified pitch. To achieve the pitch change, MD4 simply plays slower for pitch down and faster for pitch up. So if you record something at a different pitch you'll have to play it at a different speed. Be aware of this.

*Tip:* When you've finished recording at a different pitch, remember to set the pitch back to normal (i.e., Fix). Otherwise, you might record something at the wrong pitch by mistake.

### Resetting the Pitch

**1. Press the [PITCH] button.**

**2. Press the [◀] SELECT button to select Fix.**

FIX appears on the display.

**3. Press the [PITCH] button.**

Playback and recording is now performed at normal pitch.



## Using a Footswitch

An optional footswitch can be used to control MD4. Apart from a few small differences, footswitch operation is essentially the same as pressing the MD4 [PLAY] button. Connect the footswitch to the PUNCH I/O jack at the front of MD4.

The following is a summary of footswitch operations.

**Normal playback:** Play Pause → Play → Play Pause → Play →

**Auto Punch In/Out:** Record Pause → Play Record Wait → Record → Play → Play Pause

**New Recording:** New Record Pause → New Record → Stop

The following table shows footswitch operation for all MD4 modes. It also shows the status of the REHE, REC, and PLAY indicators for the various modes.

● On      ✨ Flashing

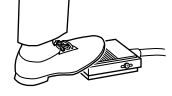
Mode Before					Mode After			
	Indicators			→		Indicators		
	REHE	REC	PLAY			REHE	REC	PLAY
Stop	—	—	—	→	Play	—	—	●
Play	—	—	●		Play Pause <sup>1</sup>	—	—	✨
Play Pause	—	—	✨		Play	—	—	●
Cue/Review	—	—	●	→	Play	—	—	●
Record Pause	—	✨	—		Play Record Wait	—	✨	●
Rehearse Pause	✨	—	—		Play Rehearse Wait	✨	—	●
Play Record Wait	—	✨	●	→	Record <sup>2</sup>	—	●	●
Play Rehearse Wait	✨	—	●		Rehearse	●	—	●
Record	—	●	●	→	Play	—	—	●
Rehearse	●	—	●		Play	—	—	●
New Record Pause	—	✨	—		New Record	—	●	●
New Record	—	●	●		Stop <sup>3</sup>	—	—	—
Auto Punch Record Standby	—	✨	—	→	Auto Punch Record Wait <sup>4</sup>	—	✨	●
Auto Punch Rehearse Standby	✨	—	—		Auto Punch Rehearse Wait <sup>4</sup>	✨	—	●

1. [PAUSE] button operation.
2. Effective only when a [REC SELECT] button is pressed.
3. [STOP] button operation.
4. After locating the Pre-Roll point, the Auto Punch In/Out sequence starts.

For the optional Yamaha FC5 Footswitch, operation is initiated when the footswitch is pressed, not when it's released. This may differ, however, with other footswitches.

## Applying Effects

The AUX SEND and AUX RETURN allow you to connect an external effects processor and apply effects to MD4 signals. Effects can be applied when recording tracks, using ping-pong, or during mixdown. Typically, reverb and delay type effects, which are often applied to several sounds in a mix, are used with this type of connection.

The input channel AUX controls are used to send signals to the effects processor. The processed signal is returned to MD4 and mixed with the original, unprocessed signal to achieve a balance before being recorded to an MD4 track, or the master recorder during mixdown.

The signal for the AUX control is sourced post-fader. So as well as turn up the AUX control, you must also raise the fader. This has the advantage that the level of the processed signal from the external effects processor is controlled in unison with the unprocessed signal that is controlled by the fader.

1. **Connect the MD4 AUX SEND jack to the external effects processor's input.**
2. **Connect the MD4 AUX RETURN jacks to the external effects processor's stereo outputs.**

The Left AUX RETURN signal is fed to the Left Stereo bus and Groups 1 and 3. The Right AUX RETURN signal is fed to the Right Stereo bus and Groups 2 and 4. So if you want to send the processed signal to both the left and right channels during mixdown, or both odd and even groups when recording tracks, you must connect to both AUX RETURN jacks.

The following illustration shows how to connect an external effects processor to MD4. Other equipment has been removed for clarity.

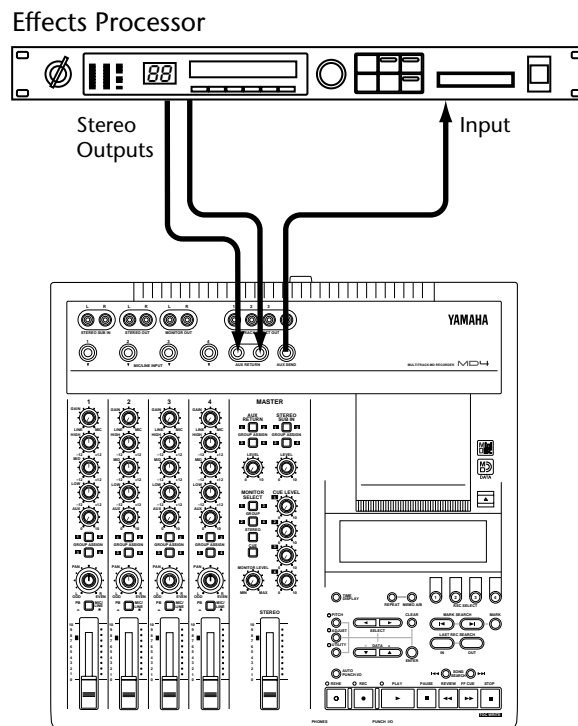

## Applying Effects at Mixdown

1. **To send a signal to the effects processor, set the input channel fader to the 7–8 mark and turn up the AUX control.**

The input channel signal is sent to the effects processor and the Stereo bus.

2. **Set the effects processor as required.**
3. **To mix the processed signal back into the stereo mix, turn up the AUX RETURN LEVEL control.**

Use the AUX RETURN LEVEL control to balance the processed signal with the dry, unprocessed signal that is coming directly from the input channel. Use the input channel fader to adjust the level of the unprocessed signal.

You can apply the same effect to other channels using the corresponding AUX controls.

## Applying Effects when Recording

1. **To send an input channel signal to the effects processor, set the fader to the 7–8 mark and turn up the AUX control.**

The input channel signal is sent to the effects processor.
2. **Use the GROUP ASSIGN switches to assign the input channel signal to a track.**

The input channel signal is sent to the specified track.
3. **Set the effects processor as required.**
4. **To send the processed signal to the track, press the AUX RETURN GROUP ASSIGN switch corresponding to the GROUP ASSIGN switch pressed in Step 2, and then turn up the AUX RETURN LEVEL control.**

Use the AUX RETURN LEVEL control to balance the processed signal with the unprocessed signal that is coming directly from the input channel. Use the input channel fader to adjust the level of the unprocessed signal.

With the balance set, you're ready to record.

## Applying Effects with Ping-Pong

1. **To send an input channel signal to the effects processor, set the fader to the 7–8 mark and turn up the AUX control.**

The input channel signal is sent to the effects processor.
2. **Use the GROUP ASSIGN switches to assign the input channel signal to the destination track.**

The input channel signal is sent to the destination track.
3. **Set the effects processor as required.**
4. **To send the processed signal to the track, press the AUX RETURN GROUP ASSIGN switch corresponding to the GROUP ASSIGN switch pressed in Step 2, and then turn up the AUX RETURN LEVEL control.**

Use the AUX RETURN LEVEL control to balance the processed signal with the unprocessed signal that is coming directly from the input channel. Use the input channel fader to adjust the level of the unprocessed signal.

With the balance set, you're ready to perform the ping-pong operation.

# 5 Quick Search Functions

This chapter explains the quick search functions.

## Searching for Songs

The [◀◀] and [▶▶] SONG SEARCH buttons can be used at any time except recording to locate songs. The [◀◀] SONG SEARCH button locates the previous song and the [▶▶] SONG SEARCH button locates the next song. When the [◀◀] SONG SEARCH button is pressed in the middle of a song, the beginning of that song is located.

When the SONG SEARCH buttons are used during playback, the song is located and then playback continues. When they are used in Stop mode, the song is located and then Pause mode is engaged.

## Searching by Time

You can locate specific points within a song or disc by entering the exact time position in minutes and seconds. When the time counter is set to either ELAPSE or REMAIN, a point within the current song can be located. When the time counter is set to TOTAL, a point on the entire disc can be located.

- 1. In Stop or Pause mode, press the [-] and [+] DATA buttons together.**  
The time counter digits flash.

- 2. Use the [-] and [+] DATA buttons to enter a time.**  
Press the [-] and [+] DATA buttons together to reset the time to 00:00.

- 3. Press the [PLAY] button.**  
The specified time is located and playback starts.

To locate to the specified point and have MD4 wait in Pause mode, press the [ENTER] button instead of the [PLAY] button.

## Searching for the Last Rec IN and OUT Points

When you record or rehearse, the start and end points of the recording are automatically stored as the LAST REC IN and OUT points. When the IN and OUT points have been set, IN and OUT appear on the display. You can use the LAST REC SEARCH [IN] and [OUT] buttons to locate these points. This is useful for checking these points. You can adjust the position of the IN and OUT points in one frame steps. See *Adjusting Markers* on page 38 for more information. The IN and OUT points are not remembered when a disc is ejected or MD4 is turned off.

The LAST REC IN and OUT points are used with the Auto Punch In/Out function and the Off Line Punch function. See *Auto Punch In/Out* on page 24 and *Track-to-Track Copy* on page 47, respectively.

## Searching for Markers

The [◀] and [▶] MARK SEARCH buttons are used to search for markers within a song. The [◀] MARK SEARCH button locates the previous marker and the [▶] MARK SEARCH button locates the next marker. For a song with no markers inserted, you can only locate to the Start and End markers.

## Inserting Markers

You can insert up to eight markers in a song during recording or playback. Markers are a convenient way to locate specific points within a song. They can be adjusted and erased. The Start and End markers, which are inserted automatically when recording, cannot be adjusted or erased.

Markers can also be used to arrange sections of a song into a Cue List. See *Cue List Playback & Copy* on page 42 for more information.

1. **To insert a marker, press the [MARK] button during recording or playback.** MARK X appears on the display for a few seconds and the corresponding marker box flashes. Press the [MARK] button again to insert further markers.
2. **When you've finished, press the [TOC WRITE] button to update the TOC.** If a new marker is inserted between two existing markers, subsequent markers are renumbered, as shown below.

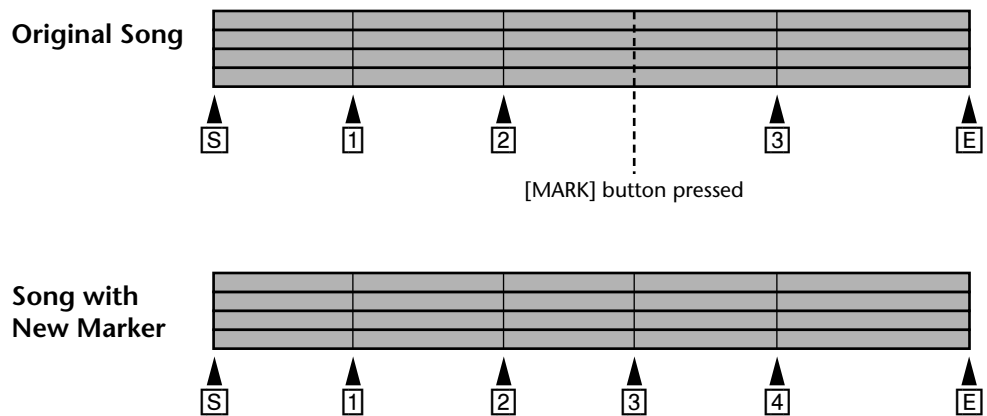

## Marker Indicators

Marker indicators show the current song position relative to markers. When a song is positioned on or after a marker, the corresponding marker indicator flashes. When the song position moves to the next marker, the next marker indicator flashes. The following illustration shows this.

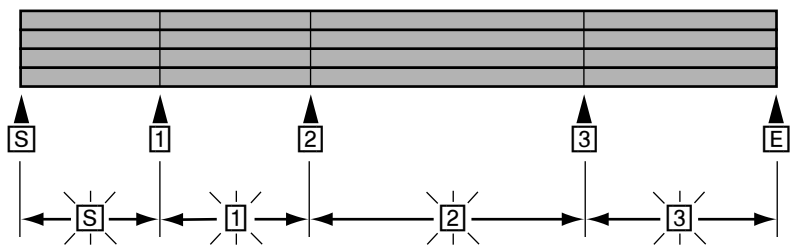

## Adjusting Markers

Once inserted, markers can be finely adjusted in one frame steps. The LAST REC IN and OUT points can also be adjusted. The Start and End markers cannot be adjusted.

**1. Press the [ADJUST] button.**

The display shows ADJUST: MARK 1

**2. Use the [◀] and [▶] SELECT buttons to select the marker that you want to adjust.**

IN and OUT refer to the LAST REC IN and OUT points.

**3. Press the [ENTER] button.**

The display shows ADJUST Load. . . and ten seconds of sound data (five seconds either side) of the marker is loaded into memory for quick playback.

When loading is complete, the sound data plays from 1.5 seconds before the marker to 1.5 seconds after the marker, as shown below.

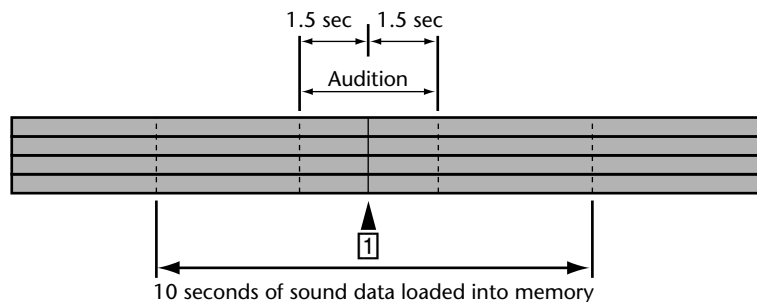

The 1.5 seconds of sound data before the marker is played at a lower volume level, so you can hear exactly where the marker occurs. To play the first 1.5 seconds at normal volume and the remaining sound data at a lower level, press the [◀] SELECT button. You can toggle between these two playback modes using the [◀] and [▶] SELECT buttons. Each time you press a SELECT button the sound data is played.

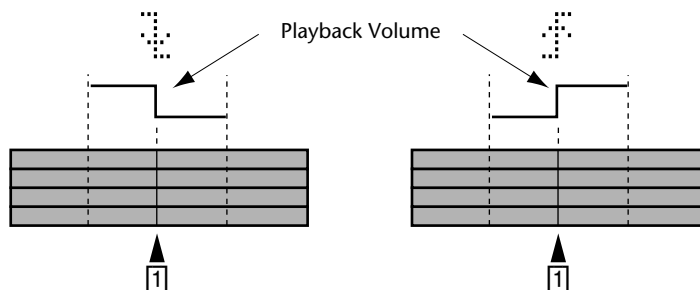

**4. Use the [-] and [+] DATA buttons to adjust the marker and the [PLAY] and [◀] and [▶] SELECT buttons to audition the new marker position.**

The marker can be adjusted in one frame steps to a new position within the 10 seconds of sound data loaded into memory. If you want to move the marker to a position beyond this range, you must use the Adjust functional several times. You cannot move a marker beyond the previous or next marker.

**5. Press the [ENTER] button to store the new position.**

Press the [STOP] button if you don't want to store the new marker position.

**6. When you've finished, press the [TOC WRITE] button to update the TOC.**

---

## Erasing Markers

1. Press the [ADJUST] button.  
The display shows ADJUST: MARK 1
2. Use the [◀] and [▶] SELECT buttons to select the marker that you want to erase.
3. Press the [CLEAR] button.  
The display shows CLR MARK 1?
4. Press the [ENTER] button to erase the marker.  
The marker is erased and existing subsequent markers are renumbered, as shown below.

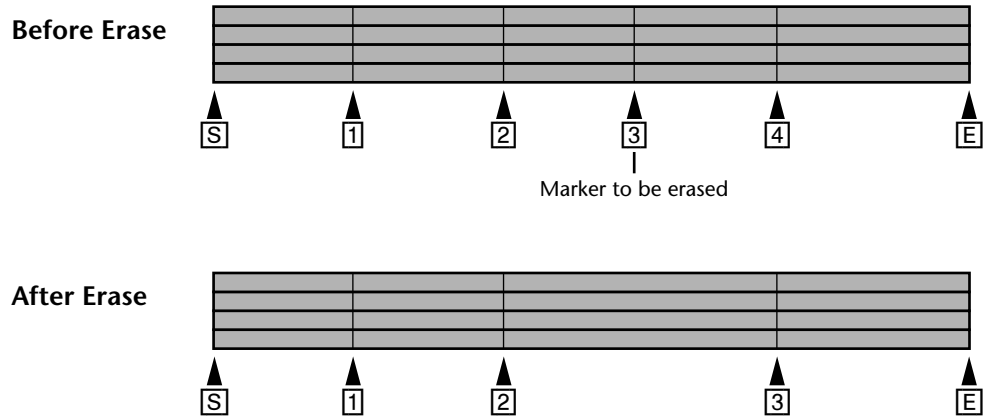

5. When you've finished, press the [TOC WRITE] button to update the TOC.

# 6 Repeat, Cue List & Program Play

This chapter explains the Repeat, Cue List, and Program Play functions.

## One Song Repeat

One Song Repeat playback allows you to play one song repeatedly.

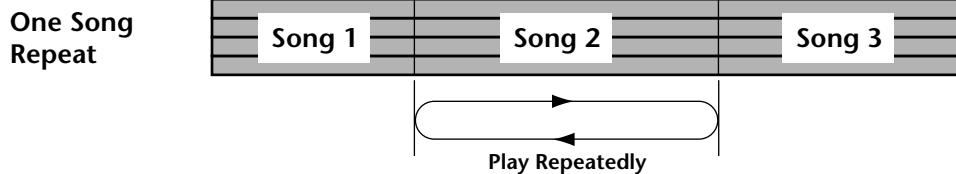

1. Use the [SONG SEARCH] buttons to select the song for repeat playback.
2. Press the [REPEAT] button.  
REPEAT 1 appears on the display.
3. Press the [PLAY] button to start playback.  
The selected song plays repeatedly.  
You can also start One Song Repeat during Play or Pause mode.
4. Press the [REPEAT] button twice to cancel One Song Repeat playback.  
One Song Repeat playback is cancelled automatically when the [STOP] button is pressed.

## All Song Repeat

All Song Repeat playback allows you to play all songs repeatedly.

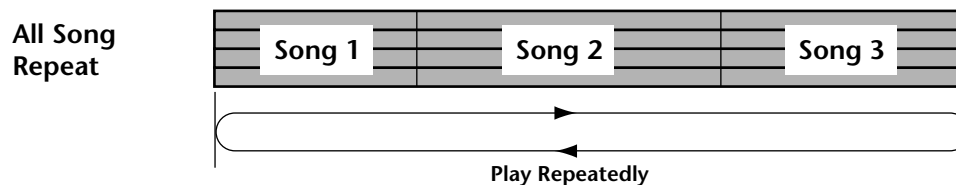

1. Press the [REPEAT] button twice.  
REPEAT ALL appears on the display.
2. Press the [PLAY] button to start playback.  
All songs play repeatedly.  
You can also start All Song Repeat during Play or Pause mode.
3. Press the [REPEAT] button to cancel All Song Repeat playback.  
All Song Repeat playback is cancelled automatically when the [STOP] button is pressed.



## A–B Repeat

A–B Repeat playback allows you to play a specific section of a song repeatedly. Playback repeats between the specified A and B points.

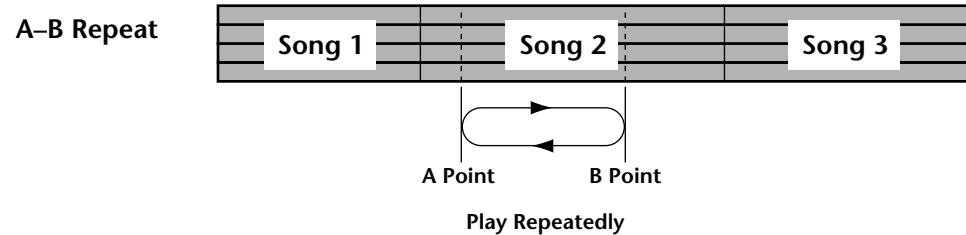

1. Press the [PLAY] button to start playback.
2. Press the [MEMO A/B] button when you hear the beginning of the section that you want to repeat.  
REPEAT MEMO A appears on the display. Point A has been entered.
3. Press the [MEMO A/B] button again when you hear the end of the section that you want to repeat.  
MEMO B appears on the display. Point B has been entered.  
The section between points A and B is played repeatedly.
4. Press the [REPEAT] button to cancel A–B Repeat.  
A–B Repeat playback is cancelled automatically when the [STOP] button is pressed.  
The specified A and B points are not remembered when A–B Repeat mode is cancelled. To keep the A–B points active, use the [PAUSE] button instead of the [STOP] button to temporarily stop A–B Repeat playback.  
The A–B Memo points are not stored when MD4 is turned off.

## Cue List Playback & Copy

The Cue List function allows you to compile a cue list (i.e., a sequence of cues for playback) using markers. Cues are loaded into memory for continuous, uninterrupted playback. The Cue List can also be copied to create a new song.

A Cue List can contain up to nine steps. You can specify the start marker, end marker, and the number of times the step is to repeat from 1 to 9.

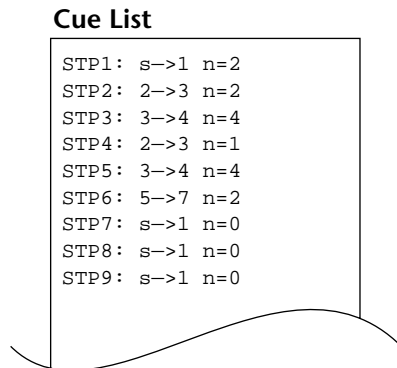

1. **Press the [UTILITY] button and use the [◀] and [▶] SELECT buttons to select the Cue List function.**
2. **Press the [ENTER] button.**  
The display shows `EDIT NEW`
3. **Use the [◀] and [▶] SELECT buttons to select EDIT or NEW.**  
EDIT allows you to edit the current Cue List. NEW resets the Cue List.
4. **Press the [ENTER] button.**  
The display shows `stp1:s→e n=0` (the lower case *stp* indicates that the Cue List is being edited).
5. **Use the [◀] and [▶] SELECT buttons to select the parameters and the [-] and [+] DATA buttons to set them.**  
To reset the number of repeats to zero, press the [CLEAR] button.
6. **When you've set all the required steps, press the [ENTER] button.**  
The display shows `CueLst PLAY?`  
To copy the Cue List to a new song, press the [+] DATA button. The display changes to `CueLst COPY?`.
7. **Press the [ENTER] button.**  
If you chose `CueLst PLAY?`, MD4 waits in Pause mode. Press [PLAY] to play the Cue List. The time counter starts at zero and counts up continuously until the last step of the Cue List has been played. The display shows the current step. For example, `STP1:1→2 n=0` (the upper case *STP* indicates that the Cue List is being played).  
If you chose `CueLst COPY?`, a new song consisting of the cues in the Cue List is created.
8. **If you are just playing the Cue List, use the [-] and [+] DATA buttons to select other steps and the [PAUSE] button to pause playback.**  
To stop Cue List Playback, press the [STOP] button.  
In rare circumstances, cue list playback may not be continuous (i.e., playback may skip between cues). Cue list settings are stored when MD4 is turned off.

## Program Playback

The Program Play function allows you to compile a program of songs for custom playback. The Program may contain up to 36 steps.

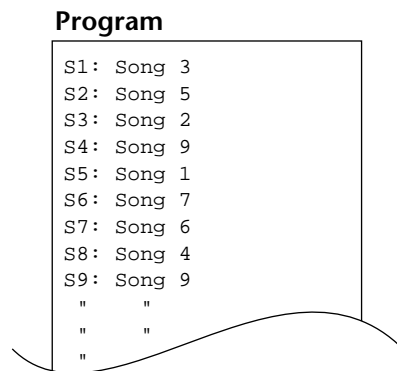

1. Press the [UTILITY] button and use the [◀] and [▶] SELECT buttons to select the PRG Play function.
2. Press the [ENTER] button.  
The display shows EDIT NEW
3. Use the [◀] and [▶] SELECT buttons to select EDIT or NEW.  
EDIT allows you to edit the current Program. NEW resets the Program.
4. Press the [ENTER] button.  
The display shows s1: \*+ \*+ (the lower case s indicates that the Program is being edited).
5. Use the [◀] and [▶] SELECT buttons to select steps and the [-] and [+] DATA buttons to select a song for each step.  
To reset a step, press the [CLEAR] button.
6. When you've set all the required steps, press the [ENTER] button.  
The display shows S1: 1+ 2 and MD4 waits in Pause mode (the upper case S indicates that the Program is being played).
7. Press the [PLAY] button to start Program playback.  
The songs play back in the order specified in the Program.
8. Use the [◀◀] and [▶▶] SONG SEARCH buttons to select other steps in the Program and the [PAUSE] button to pause playback.  
To stop playback, press the [STOP] button.

When Program Playback is paused, selecting the TOTAL Time Counter mode allows you to search for a specific point within the Program. See *Searching by Time* on page 36 for more information.

Program Play settings are stored when MD4 is turned off.

# 7 Editing Songs & Tracks

This chapter explains the edit functions that can be used with songs and tracks.

## Copying a Song

The Song Copy function allows you to duplicate a song, including title, markers, and Tempo Map. This is useful for making a backup copy before performing a ping-pong or punch in/out operation. If the ping-pong or punch doesn't turn out as expected, you can always go back to the duplicate version and try again.

1. Press the [UTILITY] button and use the [◀] and [▶] SELECT buttons to select the Song Copy function.

2. Press the [ENTER] button.

The display shows `COPY ** 3` (in this example, there are two songs recorded, so the new duplicate will be Song 3).

3. Use the [-] and [+] DATA buttons to select the Song that you want to copy.

For example: `COPY 1+ 3`

4. Press the [ENTER] button.

The display shows `COPY EXE?`

5. Press the [ENTER] button to proceed or the [CLEAR] button to cancel.

The display shows `COPYTo 3`

Songs are copied at normal play speed. You can abort the song copy operation at anytime by pressing the [STOP] button. Data up to the point that you press the [STOP] button will not be copied.

6. Press the [TOC WRITE] button to update the TOC.

The following illustration shows how the Song Copy function works.

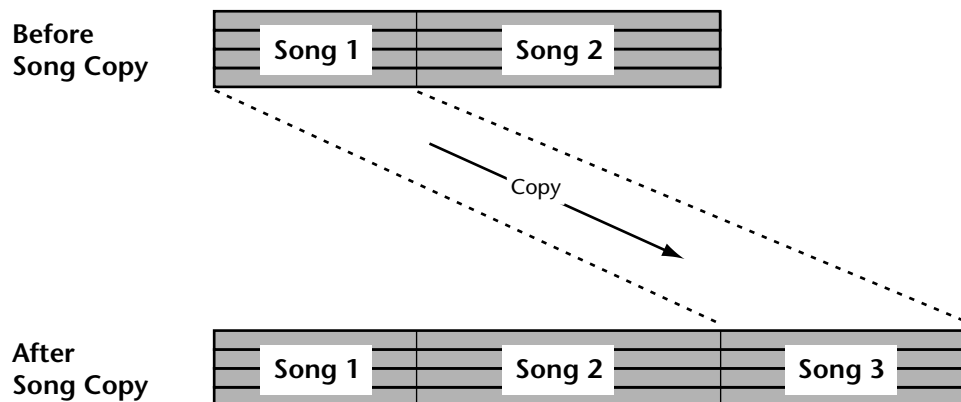

## Dividing a Song

The Song Divide function allows you to divide songs into several independent songs. Songs can also be arranged as a program for playback. See *Program Playback* on page 43 for more information.

1. **Locate the position where you want to divide the song and press the [PAUSE] button.**  
The PLAY indicators flash.
2. **Press the [UTILITY] button and use the [◀] and [▶] SELECT buttons to select the Song Divide function.**
3. **Press the [ENTER] button.**  
The display shows `Divide EXE?`
4. **Press the [ENTER] button to proceed or the [CLEAR] button to cancel.**  
The song is divided in to two. `Writing TOC` appears on the display as the TOC is updated.

If the song contained markers, those markers before the divide point stay with the original song and those markers after the divide point are renumbered and moved to the new song, as shown below.

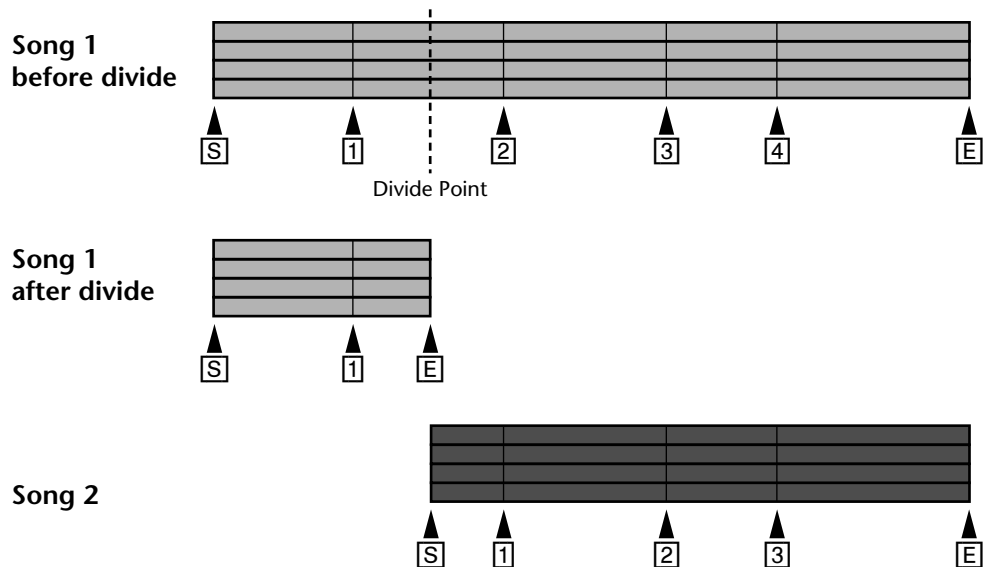

When a song is divided, subsequent songs are renumbered. For example, Song 1 is divided into Song 1 and Song 2. The previous Song 2 then becomes Song 3, and so on.

## Combining Songs

The Song Combine function allows you to combine adjacent songs that were divided using the Song Divide function. Songs that were recorded separately cannot be combined.

1. Press the [UTILITY] button and use the [◀] and [▶] SELECT buttons to select the Song Combine function.  
The display shows `Cmbn ** *`
2. Press the [ENTER] button.  
The display shows `Cmbn 1+ 2`
3. Use the [-] and [+] DATA buttons to select the Songs that you want to combine.  
For example: `Cmbn 1+ 2`
4. Press the [ENTER] button.  
The display shows `Cmbn EXE?`
5. Press the [ENTER] button to proceed or the [CLEAR] button to cancel.  
The songs are combined into one. `WritingUTOC` appears on the display as the TOC is updated.

A marker is added at the point where the songs are combined and existing markers from both songs remain valid.

If the total number of markers including the new marker at the join point exceeds eight, you will not be able to access markers above Marker number 8. These higher markers are still stored, however. So if you delete one or more of the first eight markers, they will reappear successively.

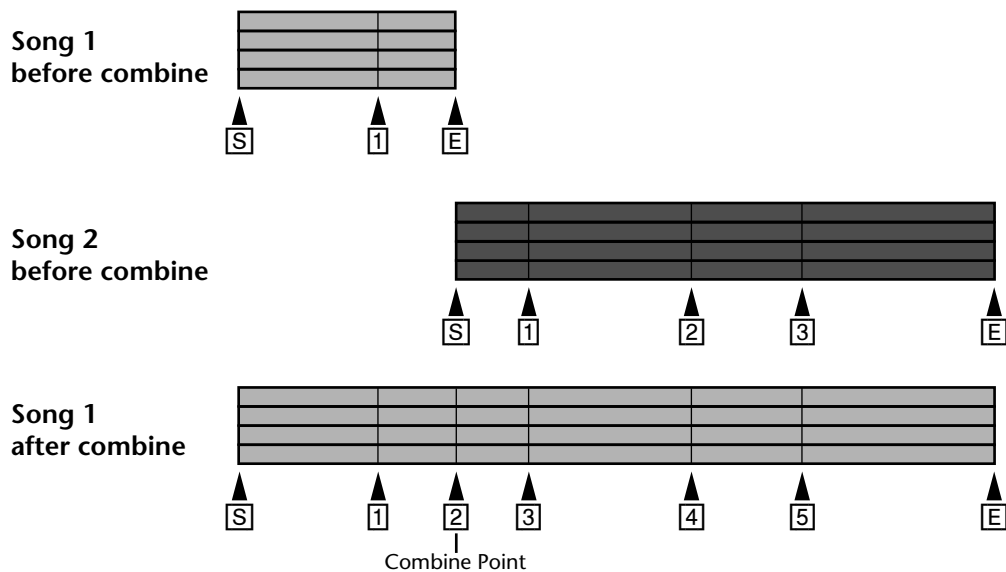

When songs are combined, subsequent songs are renumbered. For example, Song 1 and Song 2 are combined into Song 1. The previous Song 3 then becomes Song 2, and so on.

## Track-to-Track Copy

The Off Line Punch function allows you to perform track-to-track copies. The section of the source track to be copied is determined by the LAST REC IN and OUT points, and you must set these points before trying to use this function. As the copy operation is performed by the recorder, the mixer settings have no effect. The copy is recorded at the same volume level as the original. You can monitor the destination track while the copy is in progress. The Off Line Punch function also includes a rehearsal option, so you can perform a dry run before performing the actual copy.

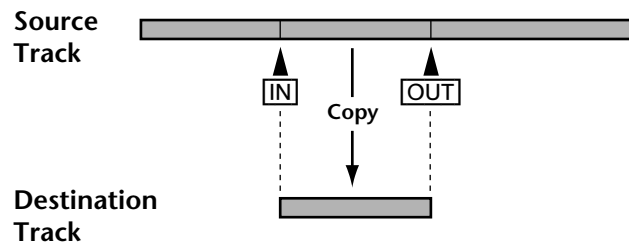

1. Press the [UTILITY] button and use the [◀] and [▶] SELECT buttons to select the OffLinePunch function.
2. Press the [ENTER] button.  
If nothing happens, you haven't yet set the LAST REC IN and OUT points. See *Setting the In/Out Points "On-the-Fly"* on page 24 for more information.  
If you have set the IN and OUT points, the display shows `PNCH *Tr→*Tr`.
3. Use the [-] and [+] DATA buttons to select the source track.  
For example: `PNCH 1Tr→*Tr`.
4. Press the [▶] SELECT button.
5. Use the [-] and [+] DATA buttons to select the destination track.  
For example: `PNCH 1Tr→4Tr`  
Existing data between the IN and OUT points on the destination track is overwritten.
6. Press the [ENTER] button.  
The display shows `PNCH REHE?`  
At this point you have the choice of performing the copy or just rehearsing it.
7. Use the [-] and [+] DATA buttons to select `PNCH REHE?` or `PNCH EXE?`.
8. Press the [ENTER] button.  
If you selected `PNCH REHE?`, the copy operation is rehearsed. You can monitor the destination track while the rehearsal is in progress. The REC SELECT indicator for the destination track lights up during the rehearsal.  
If you selected `PNCH EXE?`, the copy operation is performed. Tracks are copied at normal play speed. So copying a 1-minute section, for example, takes 1 minute.  
You can abort the track copy operation at anytime by pressing the [STOP] button. Data up to the point that you pressed the [STOP] button is copied.

## Erasing Tracks

The Track Erase function allows you to erase individual tracks.

1. **Press the [UTILITY] button and use the [◀] and [▶] SELECT buttons to select the Track Erase function.**
2. **Press the [ENTER] button.**  
The display shows `Erase ****Tr`
3. **Use the [◀] and [▶] SELECT buttons to select tracks and the [-] and [+] DATA buttons to set tracks to be erased.**  
For example: `Erase *2**Tr`
4. **Press the [ENTER] button.**  
The display shows `Erase EXE?`
5. **Press the [ENTER] button to proceed or the [CLEAR] button to cancel.**  
Tracks are erased at normal play speed. So erasing a four-minute track, for example, takes 4 minutes. You can abort the track erase operation at anytime by pressing the [STOP] button.

## Erasing Songs

The Song Erase function allows you to erase individual songs or all songs together. Erasing all songs formats a disc. A disc that has been used to store computer data must be formatted using this function before it can be used with MD4.

1. **Press the [UTILITY] button and use the [◀] and [▶] SELECT buttons to select the Song Erase function.**
2. **Press the [ENTER] button.**  
The display shows `Song No. 1`
3. **Use the [-] and [+] DATA buttons to select a single song or ALL.**  
For example: `Song No. 3`
4. **Press the [ENTER] button.**  
The display shows `Erase EXE?`
5. **Press the [ENTER] button to proceed or the [CLEAR] button to cancel.**  
The selected song is erased and subsequent songs are renumbered. `Writing TOC` appears on the display as the TOC is updated.  
The erased area becomes a recordable blank area. However, you cannot use that area for recording until it becomes the largest blank area, since only the largest blank area can be used for recording.



---

# 8 MD4 & MIDI

MIDI sequencers and MIDI controlled musical instruments have become essential tools for modern recording. It's common these days not to record MIDI instruments to tape until the final mixdown. This has the benefit of freeing up tracks for acoustic sounds and reduces the need for recorders with many tracks. MD4 is ideal for recording vocal, guitar, and other acoustic sounds and can easily be integrated into a MIDI system using either MTC (MIDI Timecode) or MIDI Clock.

MTC and MIDI Clock are MIDI messages used to synchronize MIDI devices. MD4 only transmits these messages, it does not receive them. So MD4 must be used as the master device in a synchronized MIDI system. This means that the MIDI sequencer responds to MTC or MIDI Clock information coming from the MD4. MD4 does not receive MTC or MIDI Clock from the sequencer.

## Using MD4 in a Synchronized MIDI System

The MD4 MIDI OUT jack should be connected to the MTC input of your MIDI sequencer if you are using MTC, or a normal MIDI IN if you are using MIDI Clock. MD4 transmits MTC or MIDI Clock during play, record, and rehearsal. When the MIDI sequencer receives MTC or MIDI Clock from MD4, it locates to the same time position as MD4 and plays along in synchronization.

Each MD4 song starts at 00:00.00. So you should start the MIDI sequencer song at 00:00:00:00. Your MIDI sequencer may allow you to specify a timecode offset. This allows you to start the MIDI sequencer song at a different time.

## About Tempo Maps

For use with MIDI Clock, a Tempo Map allows you to specify song tempo and meter (time signature). Each Tempo Map allows up to 26 tempo and 26 meter changes. Tempo and meter changes are organized in steps from A to Z. You can insert and delete steps as you like and they are automatically sorted. If your song does not contain any tempo or meter changes, the Tempo Map contains only a tempo and meter setting on the first beat of the first measure, which is step A.

One Tempo Map can be saved with each song. When you select a different song, you must load its Tempo Map. The Tempo Map is not stored when MD4 is turned off. You must load a Tempo Map each time MD4 is turned on.

A Tempo Map Chart is provided on page 56 to help you organize your Tempo Maps. Please feel free to photocopy it.

## Setting Up a Synchronized MIDI System

The following illustration shows how MD4 can be integrated into a MIDI-based recording system. In this example, acoustic sounds are recorded to the MD4 and MIDI devices are controlled by the MIDI sequencer, which receives MTC or MIDI Clock from MD4.

This example also shows how the MD4 DIRECT TRACK OUTs can be used to output signals directly from the MD4 tracks. The individual track sounds are sent to the other mixer for mixing with the sounds from the sequencer controlled MIDI instruments.

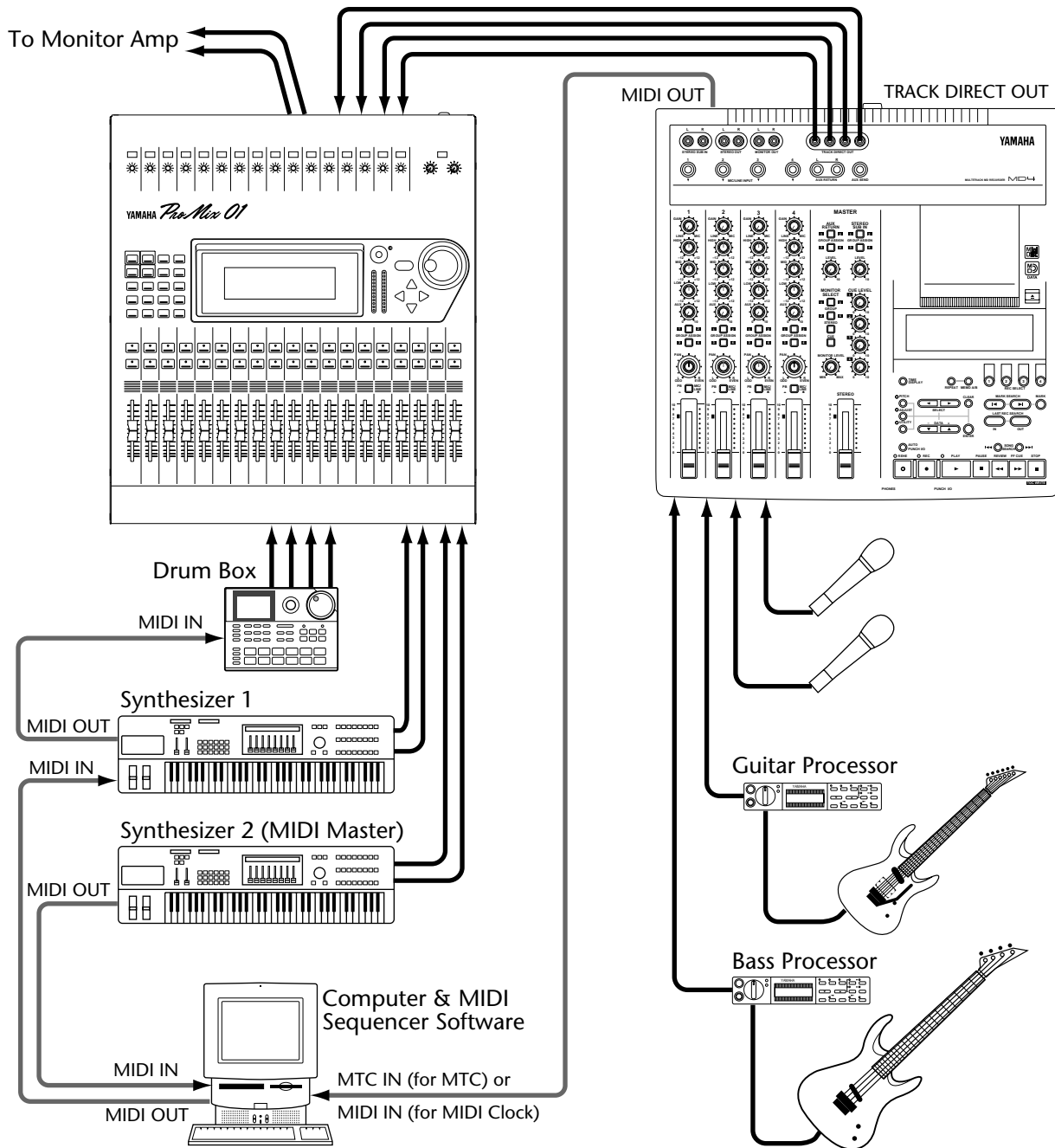

## Using MTC

### Setting MD4 for MTC Operation

1. Press the [UTILITY] button and use the [◀] and [▶] SELECT buttons to select the MIDI Sync function.
2. Press the [ENTER] button.  
The display shows OFF MTC CLK
3. Press the [▶] SELECT button to select MTC.  
MTC appears on the display.
4. Press the [UTILITY] button.  
MD4 is now ready for synchronized operation.  
When MTC is on, MD4 stops playback at the end of each song.  
MTC is turned off automatically if the Cue List or Program Play function is used.  
MD4 generates MTC at 30 frames/second.

### Setting the MIDI Sequencer

The MIDI sequencer must be set to receive and synchronize to MIDI Timecode at 30 frames/second. Refer to your MIDI sequencer's user manual for more information.

### MTC Cabling Note

The *Setting Up a Synchronized MIDI System* illustration on page 50 shows the MIDI cable from MD4 connecting to a dedicated MTC input on the MIDI sequencer. That's because MTC is best kept separate from normal MIDI data. If your MIDI sequencer does not have a dedicated MTC input, however, you may be able to merge the MTC signal with other MIDI data and connect that to the MIDI sequencer's normal MIDI input. If your MIDI data is very busy (i.e., contains a lot of real-time Control Changes), however, you may experience synchronization delay problems. For reliable operation, keep normal MIDI data and MTC separate.

## Using MIDI Clock

### Setting the MIDI Sequencer

The MIDI sequencer must be set to receive and synchronize to an external MIDI Clock source. Refer to your MIDI sequencer's user manual for more information. Exact MIDI Clock operation depends on what external synchronization features your MIDI sequencer supports. If it supports only basic MIDI Clock messages, then it will start playback at 00:00:00, but will not be able to continue playback if the song is started from a position other than 00:00:00. In this case, you will have to return to the beginning of the song each time you start playback on the MD4. If your MIDI sequencer supports MIDI Clock and MIDI Song Position Pointers, you'll be able to start playback at any point in the song. In this case, your MIDI sequencer will locate to current song position and play along in synchronization. Because MD4 can locate quickly, some MIDI sequencers may not be able to synchronize immediately with MD4, especially when MD4 is playing in A-B Repeat mode.

When MIDI Clock is on, MD4 stops playback at the end of each song.

MIDI Clock is turned off automatically if the Cue List or Program Play function is used.

### Adding Meter Changes to a Tempo Map

1. **Press the [UTILITY] button and use the [◀] and [▶] SELECT buttons to select the MIDI Sync function.**
2. **Press the [ENTER] button.**  
The display shows `OFF MTC CLK`
3. **Use the [▶] SELECT button to select CLK.**
4. **Press the [ENTER] button.**  
The display shows `Meter Tempo>`
5. **Press the [ENTER] button.**  
The display shows `EDIT NEW`
6. **Use the [◀] and [▶] SELECT buttons to select EDIT or NEW.**  
EDIT allows you to edit the current Tempo Map. NEW resets all meter steps in the Tempo Map.
7. **Press the [ENTER] button.**  
If you selected NEW, the display shows `A 001 4/4`. This is the first meter step in the Tempo Map. If your song uses the same meter all the way through, you only need to set step A.
8. **Use the [◀] and [▶] SELECT buttons to select the measure and time signature parameters, and the [-] and [+] DATA buttons to set them.**  
The measure can be set from 1 to 999. Pressing the [+] and [-] buttons together resets the measure to 000. Step A is always set to measure 1. When the measure parameter of a new step is selected (000), pressing the [-] button selects the highest measure already in the Tempo Map.  
The number of beats in a measure can be specified from 1 to 99. The type of beat can be specified as 2, 4, 8, or 16. Pressing the [+] and [-] buttons together resets the number of beats or beat type to 4.
9. **Press the [ENTER] button.**  
The Tempo Map is sorted automatically and the cursor moves to the step letter. MASTER appears on the display, indicating that MD4 is ready to generate MIDI Clock information.
10. **Use the [-] and [+] DATA buttons to select other steps and set them as expla-**

nined in step 8.

To go to the tempo section of the Tempo Map, press the [CLEAR] button, press the [▶] SELECT button, and then press the [ENTER] button.

**11. Press the [UTILITY] button.**

The Tempo Map is not stored when MD4 is turned off, so you should save it to disc. See *Saving a Tempo Map* on page 55 for more information.

## Adding Tempo Changes to a Tempo Map

**1. Press the [UTILITY] button and use the [◀] and [▶] SELECT buttons to select the MIDI Sync function.**

**2. Press the [ENTER] button.**

The display shows OFF MTC CLK

**3. Use the [▶] SELECT button to select CLK.**

**4. Press the [ENTER] button.**

The display shows Meter Tempo>

**5. Press the [▶] SELECT button to select Tempo.**

**6. Press the [ENTER] button.**

The display shows EDIT NEW

**7. Use the [◀] and [▶] SELECT buttons to select EDIT or NEW.**

EDIT allows you to edit the current Tempo Map. NEW resets all tempo steps in the Tempo Map.

**8. Press the [ENTER] button.**

If you selected NEW, the display shows A 001-1 |120. This is the first tempo step in the Tempo Map. If your song uses the same tempo all the way through, you only need to set step A.

**9. Use the [◀] and [▶] SELECT buttons to select the measure, beat, and tempo parameters, and the [-] and [+] DATA buttons to set them.**

The measure can be set from 1 to 999. The beat parameter is dependent on the number of beats in a measure, which is specified by the meter setting. For example, for a meter setting of 4/4, this beat parameter can be set from 1 to 4. For a meter setting of 6/8, this beat parameter can be set from 1 to 6. Step A is always set to measure 1-beat 1 (001-1). Pressing the [+] and [-] buttons together resets the measure and beat to 000-1. When the measure-beat parameter of a new step is selected (000-0), pressing the [-] button selects the highest measure-beat already in the Tempo Map.

The tempo can be set from 20 to 300. Pressing the [+] and [-] buttons together resets the tempo to 120.

**10. Press the [ENTER] button.**

The Tempo Map is sorted automatically and the cursor moves to the step letter. MASTER appears on the display, indicating that MD4 is ready to generate MIDI Clock information.

**11. Use the [-] and [+] DATA buttons to select other steps and set them as explained in step 9.**

To go to the meter section of the Tempo Map, press the [CLEAR] button, press the [▶] SELECT button, and then press the [ENTER] button.

**12. Press the [UTILITY] button.**

The Tempo Map is not stored when MD4 is turned off, so you should save it to disc. See *Saving a Tempo Map* on page 55 for more information.

## Inserting Steps in a Tempo Map

The Tempo Map is sorted automatically when you press the [ENTER] button. So you can insert new meter or tempo steps in any order. The following example shows how sorting works when a new meter step is inserted.

Current Tempo Map	New Meter Step	Sorted Tempo Map
A 001 2/4		A 001 2/4
B 010 3/4		B 005 6/8
C 000 4/4	C 005 6/8	C 010 3/4

The following example shows how sorting works when a new tempo step is inserted.

Current Tempo Map	New Tempo Step	Sorted Tempo Map
A 001-1 ♩120		A 001-1 ♩120
B 005-1 ♩125		B 003-1 ♩123
C 000-0 ♩120	C 003-1 ♩123	C 005-1 ♩125

## Deleting Steps in a Tempo Map

Steps that are set to measure 000 are ignored. So if you want to delete a step, set its measure to 000. When you press the [ENTER] button, the Tempo Map is sorted automatically. The following example shows how sorting works when a meter step is deleted.

Current Tempo Map	Meter Step For Deletion	Sorted Tempo Map
A 001 2/4		A 001 2/4
B 005 6/8	B 000 6/8	B 010 3/4
C 010 3/4		C 000 4/4

The following example shows how sorting works when a tempo step is deleted.

Current Tempo Map	Tempo Step For Deletion	Sorted Tempo Map
A 001-1 ♩120		A 001-1 ♩120
B 003-1 ♩123	B 000-0 ♩123	B 005-1 ♩125
C 005-1 ♩125		C 000-0 ♩120

---

## Saving a Tempo Map

1. Press the [UTILITY] button and use the [◀] and [▶] SELECT buttons to select the MIDI Sync function.
2. Press the [ENTER] button.  
The display shows OFF MTC CLK
3. Use the [◀] and [▶] SELECT buttons to select CLK.
4. Press the [ENTER] button.  
The display shows Meter Tempo>
5. Press the [▶] SELECT button twice.  
The display shows < Save Load
6. Press the [ENTER] button.  
The display shows Save EXE?
7. Press the [ENTER] button to save the Tempo Map or the [CLEAR] button to cancel.  
The Tempo Map is saved to disc.  
The disc area that is used to store Tempo Map data can hold several Tempo Maps that use all 26 steps. If not all steps in a Tempo Map can be saved, the message *SaveWarn!* appears.

## Loading a Tempo Map

1. Press the [UTILITY] button and use the [◀] and [▶] SELECT buttons to select the MIDI Sync function.
2. Press the [ENTER] button.  
The display shows OFF MTC CLK
3. Use the [◀] and [▶] SELECT buttons to select CLK.
4. Press the [ENTER] button.  
The display shows Meter Tempo>
5. Press the [▶] SELECT button three times.  
The display shows < Save Load
6. Press the [ENTER] button.  
The display shows Load EXE?
7. Press the [ENTER] button to load the Tempo Map or the [CLEAR] button to cancel.  
The Tempo Map is loaded and MASTER appears on the display.  
MD4 is now ready for synchronized MIDI Clock operation.

## Tempo Map Chart

Meter		
Step	Measure	Time Signature
A	001	/
B		/
C		/
D		/
E		/
F		/
G		/
H		/
I		/
J		/
K		/
L		/
M		/
N		/
O		/
P		/
Q		/
R		/
S		/
T		/
U		/
V		/
W		/
X		/
Y		/
Z		/

Tempo		
Step	Measure -Beat	Tempo
A	001-1	
B		
C		
D		
E		
F		
G		
H		
I		
J		
K		
L		
M		
N		
O		
P		
Q		
R		
S		
T		
U		
V		
W		
X		
Y		
Z		



# 9 MD4 Applications

This chapter shows how MD4 can be used for various applications.

## One-Take Recording

The One-Take recording technique is ideal for live recording or recording bands that like to record with all members playing together. In the following system example, vocals, guitar, and drums are recorded using microphones, while the bass is connected via a DI connection. With the optional footswitch connected to the PUNCH I/O jack, one of the musicians can stop and start MD4 recording. A stereo pair of headphones is used for monitoring.

For one-take recording, the [REC SELECT] buttons on all four tracks are set to ON. Up to eight markers can be inserted while recording by pressing the [MARK] button. Markers make it easy to locate specific points in a song.

When one-take recording is finished, the ping-pong technique can be used to make tracks available for further recording. See *Ping-Pong Recording* on page 29 for more information. Mistakes can be corrected using the punch in/out functions. See *Manual Punch In/Out* on page 21 and *Auto Punch In/Out* on page 24 for more information. Finally, EQ and effects can be applied during mixdown and transfer to a stereo master recorder.

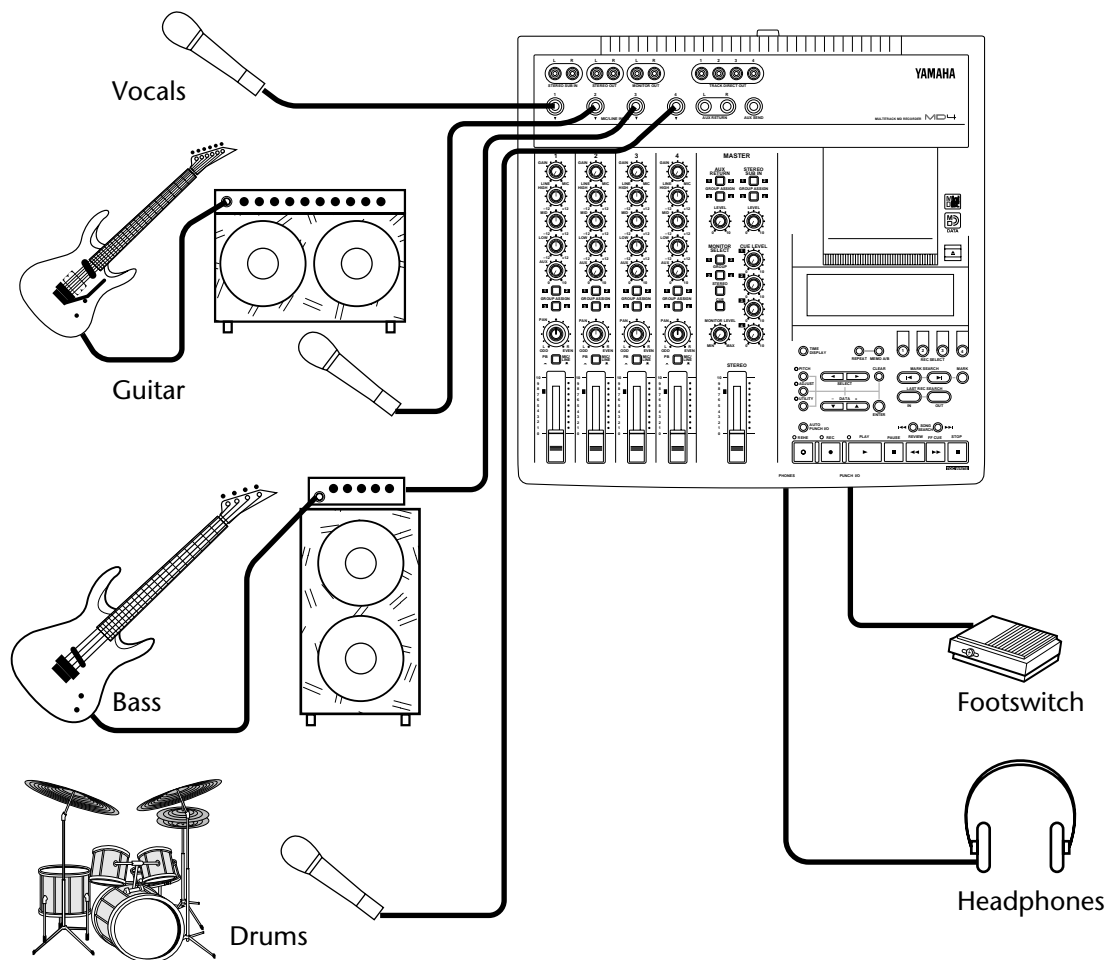

## MIDI Home Studio

In the following MIDI home studio system example, all instruments are recorded to MD4. Recording the MIDI instruments could be left until the final mixdown, since the MIDI sequencer provides repeatable playback and is synchronized to MD4 using MIDI Timecode. Having the entire project on an MD4 disc, however, does simplify media management.

A monitor amp and speakers are used for monitoring, supplemented with a pair of stereo headphones. An optional footswitch provides *hands free* recording and playback control. An external effects processor is connected to the AUX SEND and AUX RETURN jacks for effects processing. Finally, EQ and effects are applied during mixdown and transfer to the stereo master recorder.

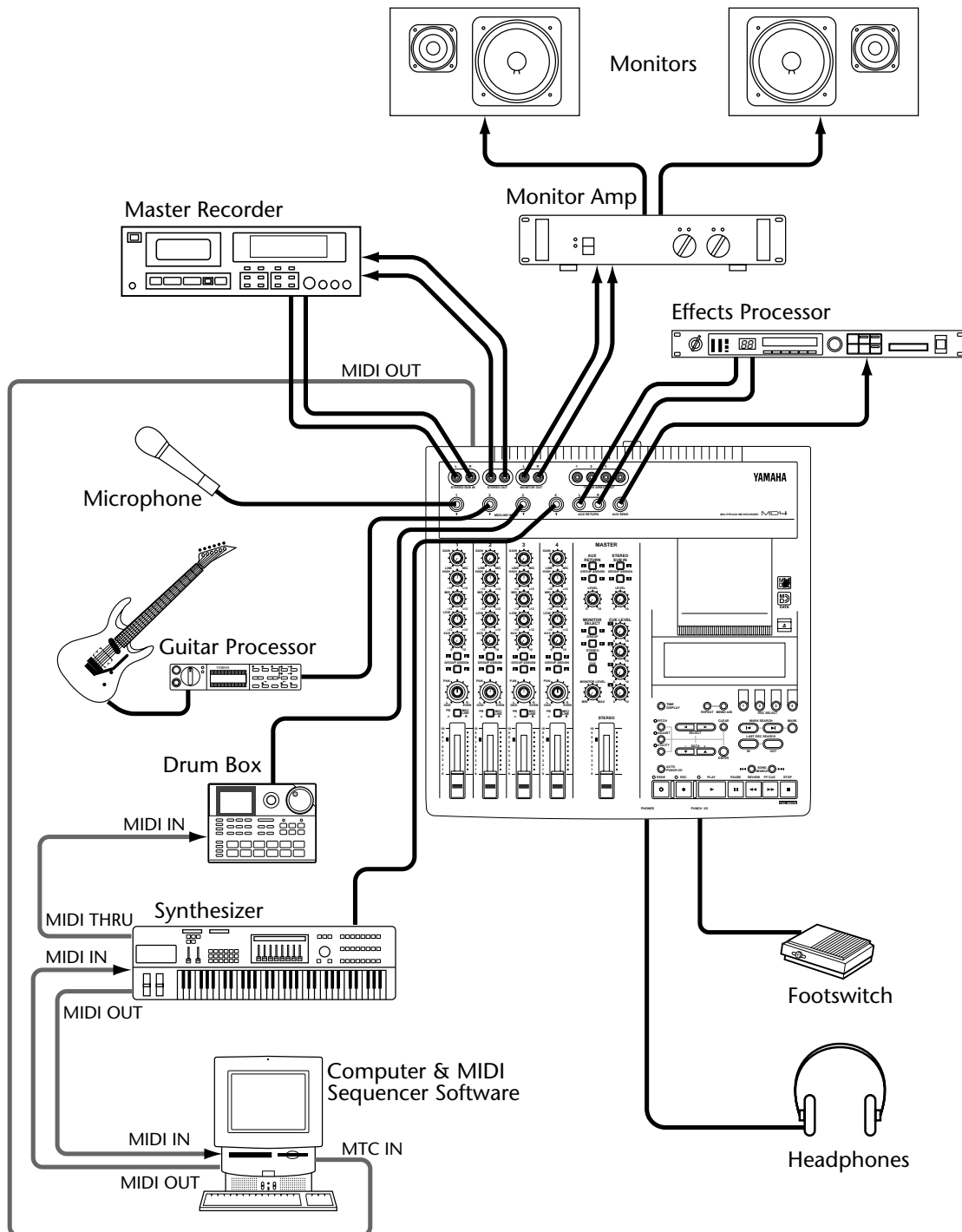

## Using MD4 with a Sub-Mixer

The MD4's four-channel mixer is flexible enough to handle most applications. If you need to expand the number of simultaneously available inputs, however, an external sub-mixer can be used. The stereo outputs of the sub-mixer can be connected to the MD4's STEREO SUB IN jacks. The STEREO SUB IN signals can then be sent to the Stereo bus for mixdown or assigned to tracks for recording. The following illustration shows how to connect a sub-mixer.

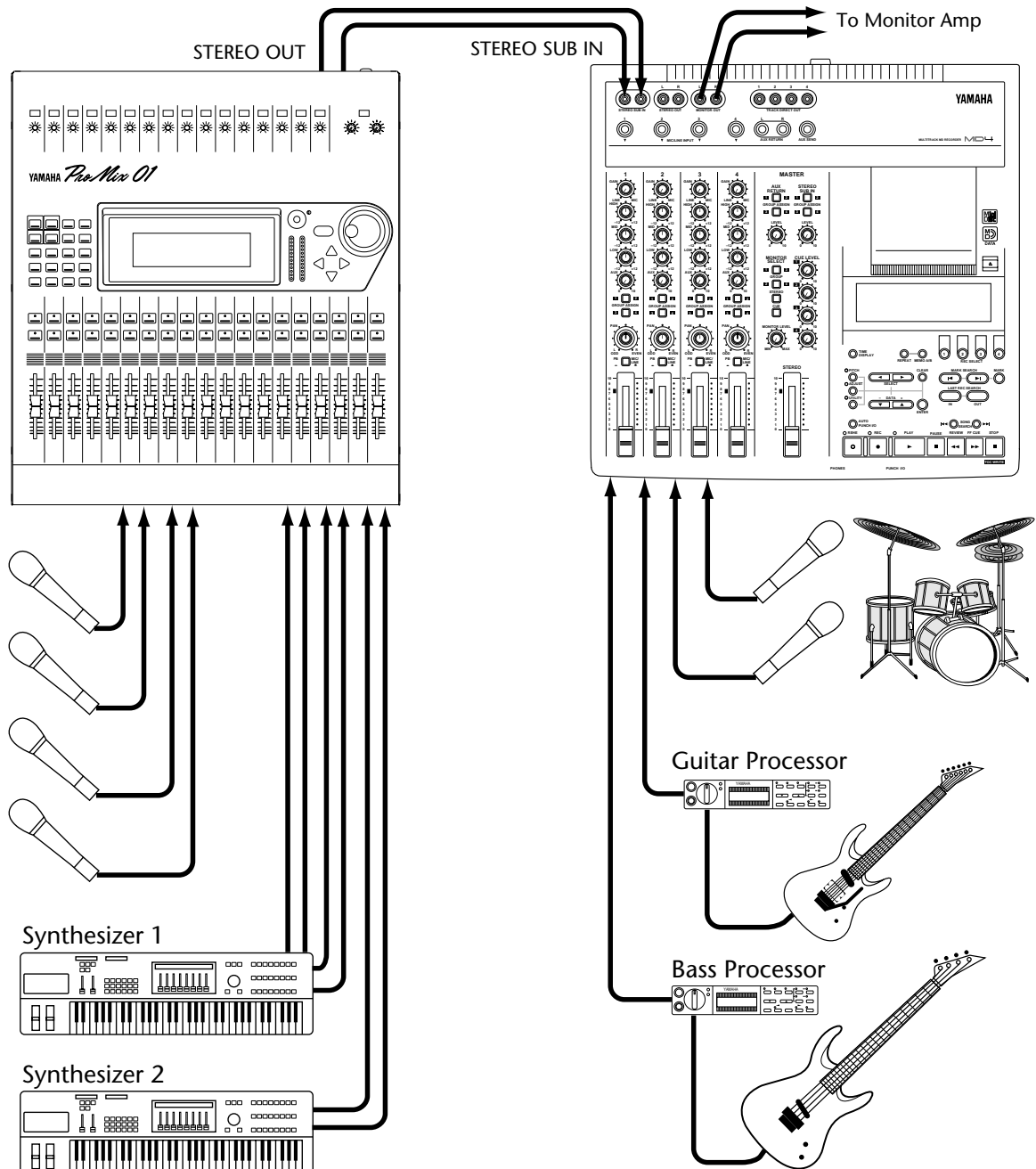

The *Quick-Start System* illustration on page 12 shows the STEREO SUB IN jacks connected to a master recorder. Note, however, that this connection is only required to play back the final mix from the master recorder. Until that time, the STEREO SUB IN jacks can be used for other applications, such as the one shown above.

## Recording a Stereo Source

For stereo recording, MD4 can be set to the Stereo recording mode. This provides a total recording time of 74 minutes. See *Setting the Recording Mode* on page 19 for more information.

The following system example shows two microphones being used for stereo recording. The actual source, however, could be any stereo device. For example, a stereo cassette deck could be connected for audio transfer from cassette tape to MD4. With an infinite life span and zero signal degradation, MD DATA discs are an excellent audio backup and archive media. If required, you can apply EQ and effects during the transfer.

Up to eight markers can be inserted while recording by pressing the [MARK] button. Markers make it easy to locate specific points in a song.

In the Stereo recording mode, MD4 uses Tracks 1 and 2. So in the following example, Input Channel 1 is assigned to Track 1 and Input Channel 2 is assigned to Track 2. See *Recording the First Track* on page 13 for information about assigning input channels to tracks. To monitor the Track 1 and Track 2 signals in stereo, press the [1–3] and [2–4] MONITOR SELECT GROUP switches. See *About Monitoring* on page 18 for more information.

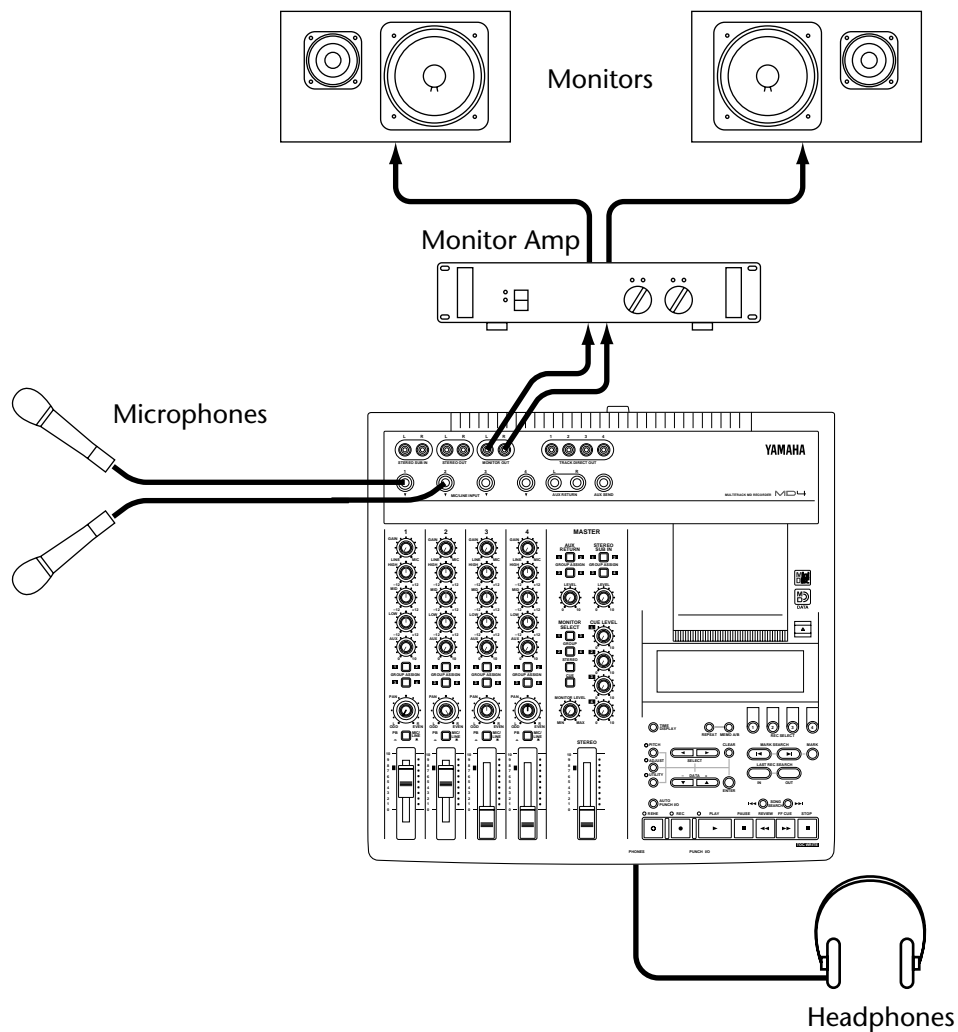

# 10 Beyond the Basics

This chapter provides some advanced tips and techniques for MD4 recording.

## AUX RETURN

You don't have to use the AUX RETURN with an external effects processor. It can be used as an extra stereo input. It accepts line-level signals that can be assigned to tracks or sent to the stereo mix. Likewise, the STEREO SUB IN can be used as an extra stereo input. It also accepts line-level signals and has GROUP ASSIGN switches and a LEVEL control. In combination with the input channels, this provides up to eight simultaneous inputs.

## EQ

EQ is not only for use during mixdown. If you are sure that a sound source requires some tone-shaping, you can use EQ for recording too. Be aware, however, that the sound will be recorded to disc that way and you cannot remove the EQ later on.

## Markers

Markers can be used to arrange sections of a song into a Cue List. This allows you to experiment with song arrangements. For example, you could use markers to identify the verse, chorus, and middle eight sections and try different arrangements using the Cue List function. You can then create a new song based on the Cue List. This allows you to create new songs just like using a sequencer. The following illustration shows how a Cue List can be used to create a new song by rearranging an existing song.

### Original Song Arrangement

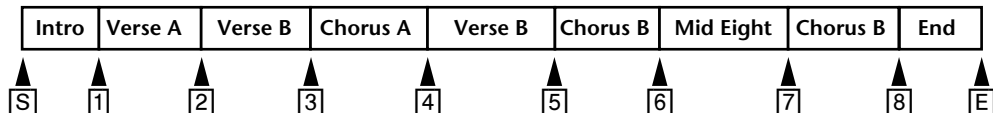

### Cue List

```
STP1: s->1 n=2 (start song with double-length Intro)
STP2: 1->2 n=2 (repeat Verse A twice)
STP3: 2->4 n=1 (Verse B to Chorus A as original)
STP4: 6->7 n=1 (have Middle Eight early)
STP5: 5->6 n=2 (back in with Chorus B twice)
STP6: 8->e n=2 (repeat Ending twice for fade out)
```

### New Song after Cue List Copy

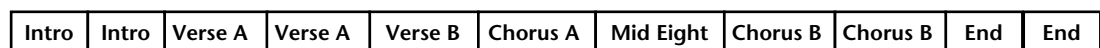

## Pitch

Adjusting the pitch is a common multitrack technique. It's useful when recording instruments that are slightly out of tune. For example, you've recorded the drum and bass parts and now it's time to record the acoustic piano part. However, the piano is a little flat. The easy way around this problem is to record the piano part at a lower pitch with the pianist playing a little slower. When you play back the recording at normal pitch, the piano part is in tune with everything else.

The Pitch function can also be used when recording a vocal phrase with high notes that a vocalist cannot quite reach. For example, drums, bass, guitar, and lead vocals have already been recorded. Now it's time to record the vocal harmonies. The vocalist, however, cannot quite reach some of the high notes. The easy way around this is to record the harmony part at a reduced pitch with the vocalist singing a little slower. When you play back the recording at normal pitch, you have the high notes of the harmony and they're in tune with everything else.

A more advanced pitch technique that can be used to capture a *super-fast* guitar solo, which is difficult to play repeatedly, is to detune your guitar so that it matches the reduced pitch of MD4. Then record the solo at the slower speed and pitch. When you play back the recording at normal pitch, you have a *super-fast* guitar solo that's in tune with everything else.

## Monitoring

Whether you use CUE or STEREO for monitoring depends on your recording method. For example, if after recording the first track you do not intend to use Input Channel 1 again (i.e., other sounds will be recorded via other channels), you can use STEREO to monitor Track 1. This allows you to pan the track and apply some EQ. Essentially, you can start building up your final mix. If, however, you intend to use Input Channel 1 again to record another music source, it's best to use CUE to monitor Track 1. If you to use the punch in/out functions, you must use CUE for monitoring.

---

## Mixdown

This section provides tips and techniques for achieving the perfect MD4 mix.

- **Balance levels**—you should already have some idea of how you want your mix to sound. This will, obviously, depend on the application and the instruments being mixed. Start with all faders positioned at the 7–8 mark. This is an optimum setting with regard to mixer performance and leaves you with some headroom to increase levels later. If one particular instrument is too quiet, rather than increasing its level it may be better to try reducing the levels of some of the other instruments. If you keep raising faders bit-by-bit, you'll soon end up with some faders set at maximum and no room for further adjustment. Vocal and instrument levels should be balanced to create an agreeable sound mix. Nothing too loud, nothing too quiet. What needs to be heard (i.e., vocals, solo instruments) can be, and backing instruments are where they belong—in the background.
- **Pan the sounds**—pan allows you to position sounds from left to right in the stereo field. This is often used to provide space for individual instruments. Bass instruments and lead vocals are usually panned around center. Rhythm guitar maybe panned to the left and lead guitar or piano, to the right.
- **Balance tonal content**—you can use EQ to filter out any unwanted hiss, hum, or frequency abnormalities in a sound. Instruments with overlapping frequencies often cause peaks at certain points in the audio spectrum when mixed. Using the EQ you can cut back some of these overlapping frequencies. This will improve the separation between instruments and provide a more tonally balanced mix. The overall sound should be tonally balanced so that the low, mid, and high bands of the audio spectrum contain an equal amount of sound energy. Too much bass or treble leads to listening fatigue. With EQ, it is often better to cut than boost.
- **Individual track monitor**—when several instruments are mixed, it can be difficult to make individual judgements about them. By temporarily setting the input selector switches on other input channels to MIC/LINE, you can monitor an individual track. If you can hear noise or other unwanted sounds, use this technique to listen to each track in isolation and correct as necessary.
- **Apply effects**—vocal and percussion sounds always benefit from the addition of a little reverb. Reverb adds that professional *sparkle* that you hear on most modern recordings. If you don't yet have an effects processor, a reverb unit is probably the most useful type of effects processor to start with. MD4 has stereo AUX RETURNS, so a reverb unit with stereo outputs works best.

# 11 Q&A Section

This section is intended to answer your questions about MD4 and MD DATA discs.

## **What's the difference between MiniDiscs and MD DATA Discs?**

MiniDiscs were designed to store mono and stereo sound data. MD DATA discs were originally designed to store computer data. Ideal for use with digital cameras. However, they can also be used to store mono, stereo, and four-channel sound data. That's how MD4 uses them.

## **Can MD4 use normal MiniDiscs?**

Yes, but only for 2-track or mono recording and playback. MiniDiscs recorded on MD4 can be played on normal MiniDisc decks.

## **What happens if I insert an MD DATA Disc into a MiniDisc deck?**

The disc will not be recognized. MiniDisc decks cannot use MD DATA discs.

## **How does MD4 know what type of disc I insert?**

MiniDiscs and MD DATA discs have a different shape on one corner. Also, the TOC on the disc contains information related to disc type.

## **How long is the life of an MD DATA disc?**

So long as the disc is not damaged physically, it has an infinite life span. Even after one million record and playback operations there is no signal degradation.

## **Do I need to format an MD DATA Disc before recording with MD4?**

No. MD4 uses MD DATA discs straight out of the wrapper. No fuss. An MD DATA disc that has been used to store computer data, however, must be formatted before use with MD4. See *Erasing Songs* on page 48 for more information.

## **Can I protect my MD4 recordings against accidental erasure?**

Yes. MD DATA discs have a write protect tab.

## **What is the available recording time?**

This depends on the Recording mode: 37 minutes for four-track (4TR), 74 minutes for stereo (2TR), and 148 minutes for mono (MONO).

## **What is the frame counter?**

A frame is an integral part of the MD DATA disc format. One frame can hold 11.6 ms of data (i.e., 512 samples of ATRAC sound data at 44.1 kHz). There are approximately 86 frames in a second.

## **Is the sound quality affected by repeated ping-pong operations?**

No—thanks to digital recording technology. Note, however, that the MD4 mixer is analog, so after many ping-pong operations slight signal degradation may occur. Although this is still insignificant when compared to tape-based analog recorders.

## **Do I have to sacrifice one track to record timecode?**

No. MD4 generates MTC (MIDI Timecode) or MIDI Clock from the disc's internal sync signals. So even in a synchronized MIDI system, all four tracks are available for sound recording.

## **How many songs can I store on an MD DATA disc?**

Up to 254.



**Is MD4 sensitive to knocks and vibration?**

Within reason, no. MD4 features a three-second sound buffer for uninterrupted operation.

**Do I have to clean the MD4 heads?**

No. In a cassette tape recorder, the head touches the tape. The MD4 heads, however, do not contact the disc. The MD4 heads are very sophisticated electronic devices. Do not interfere with them.

# Troubleshooting

If you're having difficulty operating MD4 or it doesn't seem to work as expected, look up the symptoms in the following table and follow the advice provided.

Symptom	Advice
<b>MD4 cannot be turned on!</b>	Make sure the power cord is connected to a suitable AC wall outlet and plugged into the AC IN connector at the rear of MD4.
	Make sure that the MD4 POWER switch is set to the ON position.
	If you still cannot turn on your MD4, contact your Yamaha dealer.
<b>Cannot listen to a connected music source!</b>	Make sure that the input selector switch is set to MIC/LINE. Raise the input channel fader. Assign the input channel to a track using the GROUP ASSIGN switches. Press the corresponding MONITOR SELECT GROUP switch. Turn up the MONITOR LEVEL control.
<b>Cannot record four tracks!</b>	Make sure that you are using an MD DATA disc, not a MiniDisc.
<b>Cannot record!</b>	Make sure the disc's write protect tab is set to unprotect.
	Be sure to press a [REC SELECT] button to select a track for recording?
	Make sure that you have actually assigned the signal that you want to record to the track. Use the CUE monitor controls to see if the signal is actually being sent to the track.
<b>The level meters do not indicate signal levels!</b>	Normally, the level meters indicate disc signal levels. To see the level of a group signal you must press the [REC] button to engage Record Pause mode and press the corresponding [REC SELECT] button. With no disc loaded the meters indicate group signal levels.
<b>Cannot use the Auto Punch In/Out function!</b>	You must set the LAST REC IN and OUT points to access this function.
<b>Cannot rehearse!</b>	You cannot rehearse the first recording on a blank disc. Record something first, then use the Rehearse function.
<b>Recordings play back at the wrong pitch!</b>	You may have adjusted the pitch prior to recording a track. Reset the pitch as required.
<b>Cannot access the Punch Off Line function!</b>	You must set the LAST REC IN and OUT points to access this function.
<b>Cannot use the Punch In/Out or Ping-Pong functions!</b>	If a song was edited on another MD device, MD4 may not be able to use these functions. In this case, try copying the song with the Song Copy function and then try and edit the copy.
	Songs recorded on other MD equipment may be protected by the SCMS protection system. In this case, editing is not allowed.
<b>Cannot send a channel signal to the AUX SEND!</b>	As well as turn up the AUX control you must raise the channel fader. This is because the AUX SEND signal is sourced post-fader (i.e., after the fader).
<b>Cannot make a Cue List !</b>	Make sure that the selected song contains some markers.
<b>Cannot play the Cue List!</b>	Make sure all steps in the Cue List are not set for zero repeats (n=0).
	Make sure that cues are entered in the correct order (e.g., "s->e" or "3->4", not "e->s" or "4->3").
<b>MIDI sequencer does not synchronize to MD4!</b>	Make sure that your MIDI sequencer supports MTC or MIDI Clock.
	Make sure that the MD4's MTC or CLK function is turned on. MTC appears on the display when MTC is used and MASTER appears when MIDI Clock is used.
	Make sure your MIDI sequencer is set to synchronize to an external MTC or MIDI Clock source. Refer to the MIDI sequencer's user manual.
	MD4 can locate quickly, so some MIDI sequencers may not be able to synchronize immediately, especially when MD4 is in A-B Repeat mode.
<b>A disc is loaded but the display shows No Disc!</b>	Make sure that the disc is loaded correctly.
<b>Cannot eject a disc!</b>	Press [TOC WRITE] to write the TOC data to disc. Then eject the disc.

Symptom	Advice
REMAIN (available recording time) does not increase when a song is erased!	REMAIN does not indicate the total amount of blank area on the disc (see "Searching for the Blank Top), and erasing a song does not necessarily increase the REMAINing time. However, if you erase a song, you can extend the previous song. You can also record data in the erased area if that area is the largest blank area.

## Appendix

### MD4 Transport Modes

● On      ✱ Flashing

Mode	Indicators			MD4 Status
	REHE	REC	PLAY	
Stop	—	—	—	No activity.
Play	—	—	●	Normal playback
Play Pause	—	—	✱	Playback is paused.
Cue FF	—	—	●	Quick preview at either 2X or 4X play.
Review	—	—	●	Quick review at either 2X or 4X play.
Record Pause	—	✱	—	Recording is paused.
Record	—	●	●	Recording in progress.
Rehearse Pause	✱	—	—	Rehearsal is paused.
Rehearse	●	—	●	Rehearsal in progress.
New Record	—	●	●	A new song is being recorded.
New Record Pause	—	✱	—	New song recording is paused.
Auto Punch Record Standby	—	✱	—	The Auto Punch In/Out function has been activated and MD4 is standing by to start the Auto Punch recording sequence.
Play Record Wait	—	✱	●	The Auto Punch recording sequence has started and is currently between the Pre-Roll point and the Punch IN point.
Auto Punch Rehearse Standby	✱	—	—	The Auto Punch In/Out Rehearse function has been activated and MD4 is standing by to start the Auto Punch rehearsal sequence.
Play Rehearse Wait	✱	—	●	The Auto Punch rehearsal sequence has started and is currently between the Pre-Roll point and the Punch IN point.

## Display Messages

Message	Meaning
ADJST Abort	The [STOP] button was pressed, so the Adjust function was cancelled.
A.PNCH Abort	The [STOP] button was pressed, so the Auto Punch In/Out function was cancelled.
Blank Disc	The disc is blank.
BLANK TOP	MD4 is located at the Blank Top position.
CLK OFF !	MIDI Clock was turned OFF automatically because you selected the Program Play or Cue List function.
CmbnProhibit	MD4 cannot combine these two songs because they were not split using the Song Divide function, or MD4 cannot edit this type of song.
Copy Abort	The [STOP] button was pressed, so the Song Copy function was cancelled.
CopyProhibit	This song cannot be copied because it's copy protected.
CueList Err	The Cue List is not valid.
CueLst Abort	The [STOP] button was pressed, so the Cue List Copy function was cancelled.
Disc FULL	The disc is full. You cannot record any more data.
Disc Locked	You cannot eject the disc because MD4 is recording or the TOC needs updating.
DiscErr xx	A disc scratch or defect was discovered while recording. Replace the disc.
Erase Abort	The [STOP] button was pressed, so the Track Erase function was cancelled.
Erase Warn!	This song has been write protected by another recorder. Press [ENTER] to erase or [CLEAR] to cancel.
Error xx	A fatal error occurred. Contact your Yamaha dealer.
IN/OUT Err	The IN or OUT point is not valid, so you cannot use Auto Punch In/Out.
Invalid Song	This song is not compatible, so MD4 cannot play it.
Load Err	There is no Tempo Map for this song on the disc.
LoadProhibit	The data area for the Tempo Map (UTOC sector 4) is formatted differently.
Load Warn !	Not all the Tempo Map steps could be loaded. The Tempo Map data was probably saved by another recorder.
MARK Failed	No more markers can be inserted because the song contains the maximum of eight, or you tried to insert a marker at the position of an existing marker.
MTC OFF !	MTC was turned OFF automatically because you selected the Program Play or Cue List function.
No Blank	No blank area can be found for further recording.
No Disc	No disc is loaded.
OPEN	The disc compartment is open.
PNCH Abort	The [STOP] button was pressed, so the OffLine Punch function was cancelled.
Read Cancel	TOC reading was cancelled because you pressed the Eject button.
Reading TOC	MD4 is reading the TOC from disc.
REC Prohibit	MD4 cannot record over this type of song, so you cannot overwrite this song.
REHEProhibit	MD4 does not have permission to record in this mode, so you cannot rehearse a recording that would overwrite this song.
Reload Disc	MD4 is waiting for you to reload the disc.
Save Err	No song is selected. You cannot save Tempo Map data in the Blank Top area.
SaveProhibit	The song is write protected or data area for the Tempo Map (UTOC sector 4) is formatted differently.
Save Warn !	Not all the Tempo Map steps can be saved because the data area is full.
UTOC FULL	The TOC area is full, so not all of the song title or Tempo Map could be saved.
Write Protect	The disc's write protect tab is set to protect, so you cannot record.
Writing TOC	MD4 is writing the TOC to disc.

# Signal Flow Chart

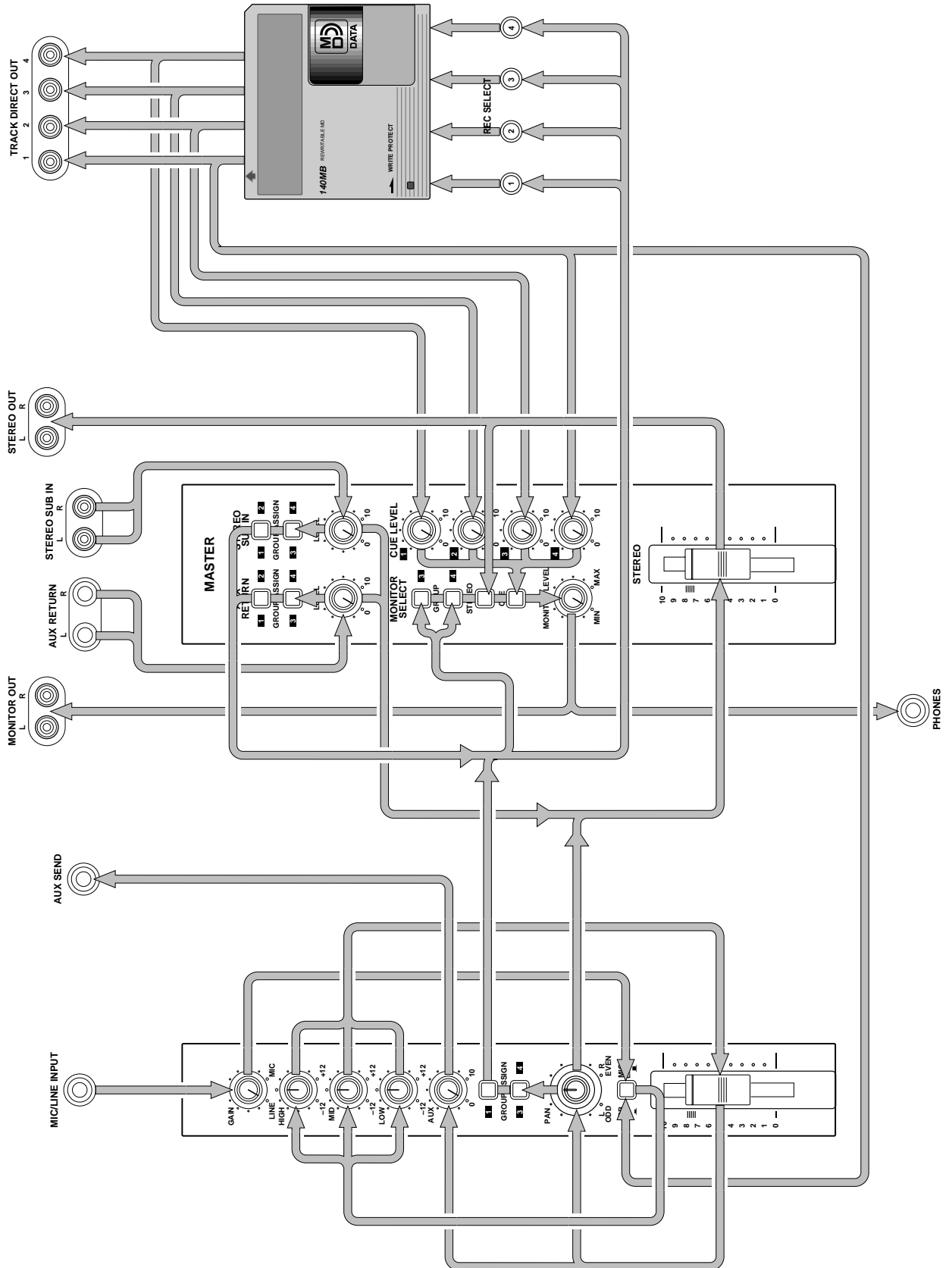

# Specifications

## Recorder

<b>Digital/Audio</b>	Sampling Frequency: 44.1 kHz	Compression: ATRAC
	Frequency Response: 20 Hz–20 kHz	
	THD+N: 0.01% typ. (1 kHz)	
	S/N: 85 dB typ.	
<b>Rec/Play</b>	4-track independent simultaneous record/play (Recording time: 37 min)	
	Dubbing with 4-track playback	
	Auto & Manual Punch In/Out (11.6 ms accuracy)	
	Stereo or Mono record/play (Stereo: 74 min. Mono: 148 min)	
	Repeat play A-B, Single song, All song	
	Vari-pitch ( $\pm 6\%$ )	
<b>Locate</b>	Start and End point of Song	Direct Time Locate
	8 mark locate points for each song	Last Recording In/Out point
<b>Cue &amp; review</b>	2- & 4-times play speed	
<b>Song Editing</b>	All Erase	
	Divide, Combine, Erase	
	Cue List-style playback for each song using Mark Search function	
<b>Title Editing</b>	Disc title, Song title	
<b>Panel Controls</b>	REC SELECT buttons 1–4	
	Transport buttons: PLAY, STOP, PAUSE, REC, REHEARSAL, CUE, REVIEW, SONG SEARCH	
	Mode buttons: AUTO PUNCH I/O, PITCH, TIME DISPLAY, ADJUST, UTILITY	
	Cursor buttons: SELECT, DATA (–, +)	
	Locate buttons: MARK, MARK SEARCH, LAST REC (IN/OUT), REPEAT, MEMO A/B	
<b>MIDI</b>	MIDI OUT	
<b>Display</b>	FLD (Fluorescent Display)	

## Mixer

<b>Inputs</b>	MIC/LINE INPUT x4	Phone jack (–50 to –10 dB)
	AUX RETURN (L, R) x1	Phone jack (–10 dB)
	STEREO SUB IN (L, R) x1	Phono (–10 dB)
<b>Outputs</b>	TRACK DIRECT OUT x4	Phono (–10 dB)
	STEREO OUT (L, R) x1	Phono (–10 dB)
	MONITOR OUT (L, R) x1	Phono (–10 dB)
	AUX SEND x1	Phone jack (–10 dB)
	PHONES OUT x1	Stereo phone jack (100 mW per 40 $\Omega$ )
<b>EQ</b>	3-band, $\pm 12$ dB (LOW: 80 Hz shelving. MID: 1 kHz Peaking. HIGH: 12 kHz Shelving)	
<b>MASTER Channel Features</b>	Stereo Fader (45 mm)	
	Playback Cue Level Control 1–4	
	Monitor/Phone monitor select, Level Control	
<b>Aux Return</b>	Level Control	
<b>Stereo Sub In</b>	Level Control	

0 dB is referenced to 0.775 V r.m.s.

## General

<b>Power Requirements</b>	Local AC Current	
<b>Power Consumption</b>	26 W	
<b>Dimensions (W x H x D)</b>	37.6 x 7.23 x 36.4 cm (14.8" x 2.8" x 14.3")	
<b>Weight</b>	4.9 kg (10.8 lbs)	
<b>Operating Conditions</b>	<b>Temperature</b>	5°C–35°C (41°F–95°F)
	<b>Humidity</b>	10%–95%
<b>Supplied Accessories</b>	AC power cord, <i>Owner's Manual</i> , MD DATA disc	
<b>Optional Accessories</b>	FC5 Footswitch	

# Block Diagram

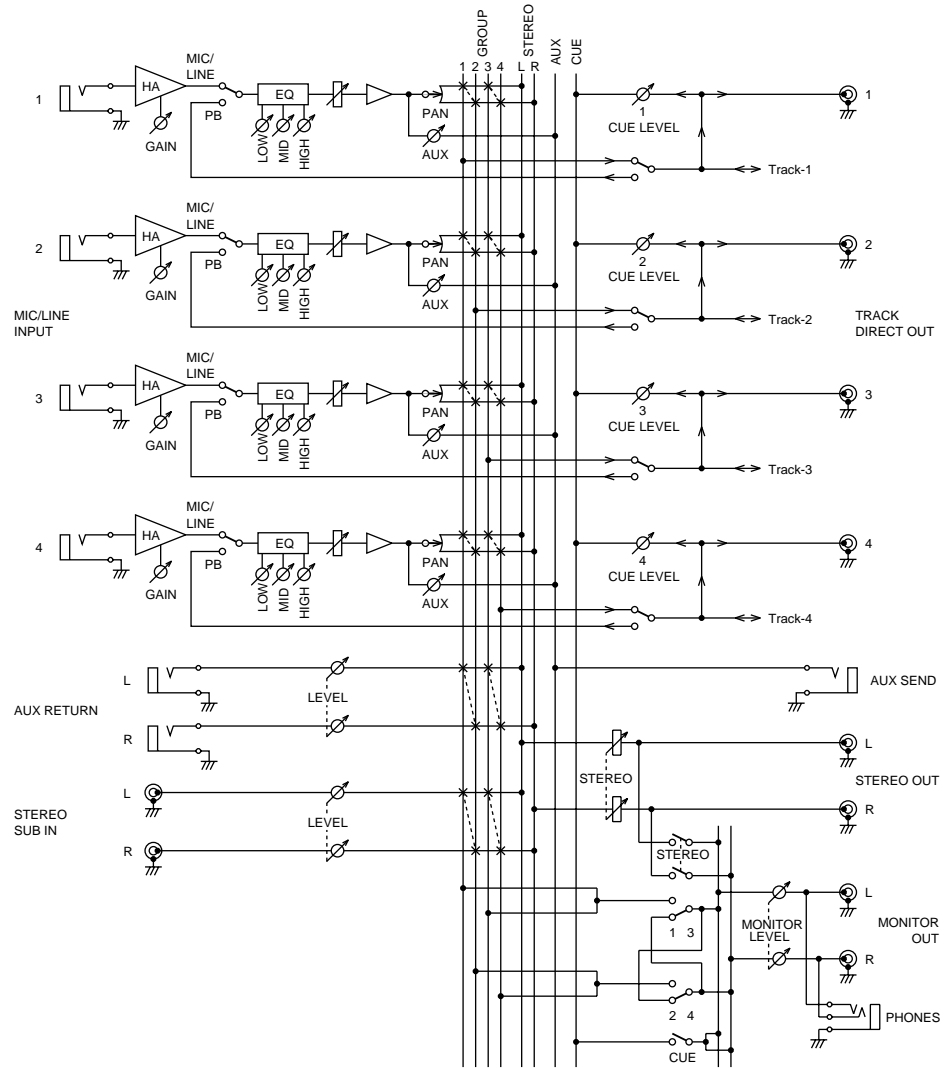

# Dimensions

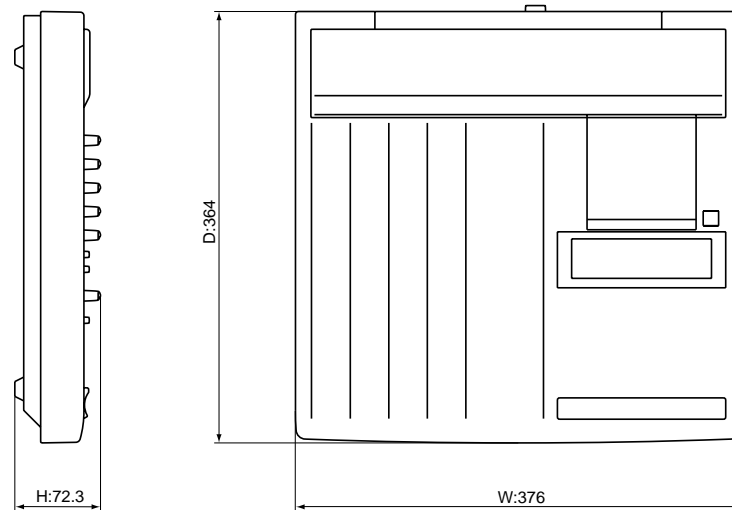

• Specifications subject to change without notice.

---

# Glossary

**ATRAC**—An acronym for Adaptive Transform Acoustic Coding. This is the compression technique used to fit the same amount of data as that of a 120 mm CD on a 64 mm MiniDisc. Using the ATRAC system, the MD4 provides a four-track recording time of 37 minutes. ATRAC uses established psychoacoustic principles to compress audio data to approximately one-fifth of its original size, with virtually no loss in sound quality. The *threshold of hearing* principle states that the sensitivity of the human ear is frequency dependent. Two tones of the same level but at different frequencies will not be heard at the same loudness. Another principle used is the *masking effect*. That is, softer sounds become inaudible when louder sounds at similar frequencies are present.

**Blank Top**—This is the start point of the largest unrecorded area on a disc. To record a new song on a disc that already contains some songs, you must first locate the Blank Top. See *Searching for the Blank Top* on page 19 for more information.

**Bouncing**—See Ping-Pong.

**Bus**—A common conductor used to collect and distribute audio signals. MD4 has four Group buses that feed the tracks, a Stereo bus consisting of left and right channels, an AUX bus for the AUX SEND, and a CUE bus for the cue monitor.

**Clipping**—The unwanted distortion effect of overloading an audio circuit with a signal that is too large. Care must be taken when setting MD4 GAIN controls so as not to overload the recording circuits. See *Recording the First Track* on page 13 for more information.

**Cue**—There are three kinds of cue on MD4. 1) Monitor CUE. 2) Cue List cue. 3) FF CUE See Monitor CUE, Cue List, and FF CUE.

**Cue List**—The Cue List function allows you to compile a cue list (i.e., a sequence of cues for playback) using markers. Cues are loaded into memory for continuous, uninterrupted playback. A new song can be created from the Cue List using the Cue List Copy function. See *Cue List Playback & Copy* on page 42 for more information.

**DAT**—An acronym for Digital Audio Tape. DAT recorders are especially popular in recording studios for recording the final stereo mix.

**DI (Direct Inject)**—A technique for connecting an electric guitar or bass guitar directly to a mixer. The high output impedance of the guitar is matched with the low impedance of the mixer input using a DI Box. Some instrument amplifier's feature a DI connection.

**EQ**—An acronym for an audio equalizer. MD4 input channels feature three-band EQ.

**EXE**—An abbreviation for Execute. This appears on the MD4 display when you are prompted to confirm a function.

**FF CUE**—This is the name of the disc transport button that allows you to preview at X2 or X4 normal playback speed.

**Footswitch**—A foot operated switch. Several MD4 transport functions and the punch in/out function can be controlled using an optional footswitch.

**Frame**—An integral unit of the MD DATA disc format. One frame can hold 11.6 ms of data (i.e., 512 samples of ATRAC sound data at 44.1 kHz). There are approximately 86 frames in a second.

**Group**—A group is essentially the same as a track on MD4. That is, when an input channel is assigned to Group 3, the signal is sent to Track 3 for recording.

**Line-Level Signal**—A signal in the range from -20 dB to +20 dB. These are essentially high-level signals. Most audio equipment outputs signals at line level. All MD4 inputs and outputs support line-level signals. *Contrast with* Low-Level Signal.



---

**Low-Level Signal**—A signal in the range from  $-100$  dB to  $-20$  dB. Microphone and electric guitar signals are in this range. MD4 MIC/LINE inputs support low-level signals. *Contrast with Line-Level Signal.*

**MiniDisc**—A compact data storage medium designed to store music. MiniDiscs come in two varieties: playback only and recordable. MiniDiscs can only be used for 2-track or mono recording with MD4. MiniDiscs recorded on MD4 can be played on a normal MiniDisc deck. *See also Random Access, ATRAC, and MD DATA Disc.*

**MD DATA Disc**—A compact data storage medium designed to store computer-type data. Although similar to MiniDiscs, they are not interchangeable. MD DATA discs come in two varieties: playback only and rewritable. MD4 uses the rewritable type for recording. *See Buying Discs for MD4 on page 2 for more information.*

**MIDI**—An acronym for Musical Instrument Digital Interface. An internationally agreed standard that allows electronic musical instruments and audio equipment to communicate.

**MIDI Clock**—A clock signal transmitted as MIDI data. MIDI Clock refers to a timing signal and Start, Continue, and Stop commands. MD4 can supply MIDI Clock to a MIDI sequencer for synchronized operation.

**MIDI Song Position Pointer**—A type of MIDI message that is used to derive position information from a MIDI Clock signal. The MD4 generates MIDI Song Position Pointers. So no matter where you start playback in a song, your MIDI sequencer will locate to that point and then play along in synchronization.

**MIDI Timecode**—*See MTC.*

**Mixdown**—The process of mixing the individual track signals into a well-balanced stereo mix. Mixdown is the final stage of the multitrack recording process.

**Monitor CUE**—The cue monitor allows you to monitor individual tracks as they are being recorded or played back. In Record Pause mode and during recording, the CUE monitor source is the signal being recorded (i.e., the input signal). For playback the CUE monitor source is from disc (i.e., the signal that was recorded to disc). This is useful with the punch in/out functions, because you can monitor the recorded signal up to the specified IN point, and then the new signal that's being recorded up to the OUT point.

**MTC (MIDI Timecode)**—An addition to the MIDI Standard that allows audio equipment to be synchronized. MIDI Timecode contains clock and position information. MD4 can supply MTC to a MIDI sequencer for synchronized operation.

**Multitracker**—An all-in-one recording and mixing device usually with four or eight tracks. MD4 is the first multitracker to use the MD DATA disc format.

**Nominal Level**—*See Operating Level.*

**One-Take Recording**—A recording technique in which all sounds are recorded in one go (i.e., no overdubs). This is used for live recording.

**Operating Level**—This is the signal level at which a piece of audio equipment is designed to operate. The two most common operating levels are  $-10$  dBV (316 mV), which is used for semi-professional equipment, and  $+4$  dBu (1.23 V), which is used for professional equipment.

**Overdub Recording**—The process of recording additional sounds while listening to previously recorded sounds. It allows songs to be built up track-by-track.

**Panning**—A technique used to position sounds in a stereo mix.

**PB**—An abbreviation for Playback. This abbreviation appears next to the input selector switch on each input channel and is used to select the disc signal as the source for the input channel.

**Phone Jack**—A 1/4-inch socket commonly used on audio equipment.

**Phono Jack**—Also known as an RCA jack, this type of connector is often used on semiprofessional audio and video equipment.

**Ping-Pong**—A recording technique used to transfer (i.e., mix and rerecord) one or more tracks to other tracks to free up those tracks for further recording. MD4 allows you to record on all four tracks and then ping-pong (i.e., four-track playback with ping-pong). A feature unique to MD4.

**Pre-Roll Time**—For Auto Punch In/Out, this is the time before the IN point at which playback starts. See *Setting the Pre-Roll & Post-Roll Times* on page 28 for more information.

**Post Fader**—A point in the signal path after a fader. The signals for the MD4 AUX controls are sourced post-fader. So as well as turn up the AUX control, you must also raise the fader. This has the advantage that the level of the processed signal from the external effects processor is controlled in unison with the unprocessed signal that is controlled by the fader.

**Post-Roll Time**—For Auto Punch In/Out, this is the time after the OUT point at which playback stops. See *Setting the Pre-Roll & Post-Roll Times* on page 28 for more information.

**Program**—A compilation of songs for custom playback. See *Program Playback* on page 43 for more information.

**Punch In/Out**—A recording technique that allows you to rerecord specific sections of an existing track. MD4 provides both manual and automatic punch in/out operations.

**Random Access**—The ability to access data instantly. The MD4 quick locate functions allow you to locate any point instantly. Tape-based recorders do not have random access capabilities because they have to wind a tape, which takes time.

**SCMS (Serial Copy Management System)**—A protection system intended to prevent illegal copying of music. SCMS allows one-time serial copying of copy-protected material. If the source is not copy protected, it's possible to make any number of digital-to-digital copies of the material. If the source is copy protected, however, it's possible to make a first-generation copy, but further copies cannot be made from the first-generation copy. SCMS is only effective when copying via digital connections. Recordings made via analog connections are not affected.

**Signal**—Sounds travel through audio equipment as electrical signals.

**Signal to Noise Ratio (S/N)**—In an audio system, the difference between the nominal signal level and the residual noise floor, usually expressed as a ratio in decibels. It's used as a measure of an audio system's noise performance.

**Tempo Map**—A map containing the tempo and meter information for a song.

**TOC**—An acronym for Table Of Contents. An area of the MD DATA disc used to store information about what is recorded on the disc, the disc title, song titles, and so on.

**Tracking**—The process of recording sounds to tracks on a audio recorder. Also know as *laying down tracks* and just plain simple *recording*. Tracking is the first stage of the multitrack recording process.

**Unity Gain**—A gain of one. That is, the signal is output from a circuit at the same level at which it entered. Once passed the MIC/LINE amplifier, a unity gain system minimizes signal noise and distortion. The unity gain position for MD4 faders is at the 7–8 mark.

# Index

## A

A.PNCH Abort, message 68  
 A–B repeat 41  
 AC IN connector 11  
 ADJUST Abort, message 68  
 ADJUST button 8  
 Adjusting markers 38  
 Advanced multitracking 17  
 All song repeat 40  
 Applications  
   MIDI home studio 58  
   one-take recording 57  
   stereo recording 60  
 Assign, *see* Group assign  
 ATRAC, definition 72  
 Auto punch  
   indicator 7  
   operation 26  
   rehearsal 25  
   using footswitch 27  
 AUTO PUNCH I/O button 8  
 AUTO PUNCH indicator 7  
 Auto Punch Record Standby mode 67  
 Auto Punch Rehearse Standby mode 67  
 AUX control 4  
 AUX RETURN  
   beyond the basics 61  
   connecting 34  
   connectors 10  
   GROUP ASSIGN switches 5  
   LEVEL control 5  
 AUX SEND connector 10

## B

Basic multitracking 17  
 Beyond the basics 61  
 Blank Disc, message 68  
 Blank top, definition 72  
 BLANK TOP, message 68  
 Block diagram 71  
 Bouncing tracks 29  
 Bus, definition 72  
 Buying discs 2

## C

Channel inputs 4  
 CLEAR button 9  
 Clipping, definition 72  
 CLK OFF!, message 68  
 CmbnProhibit, message 68  
 Combining Songs 46  
 Compiling a program 43  
 Connectors  
   AC IN 11  
   AUX RETURN 10  
   AUX SEND 10  
   MIC/LINE INPUTs 10  
   MIDI OUT 11  
   MONITOR OUT 10  
   PHONES 11  
   POWER ON/OFF switch 11  
   PUNCH I/O 11  
   STEREO OUT 10  
   STEREO SUB IN 10  
   TRACK DIRECT OUT 10  
 Copy Abort, message 68  
 Copying  
   cue list 42  
   songs 44  
   tracks 47  
 CUE  
   level controls 5  
   MONITOR SELECT switch 5  
 Cue FF 67  
 Cue list  
   copy 42  
   definition 72  
   playback 42  
 Cue, definition 72  
 CueList Err, message 68  
 CueLst Abort, message 68

## D

DAT, definition 72  
 DATA buttons 9  
 Dimensions 71  
 Direct outputs 10  
 Disc format indicators 6  
 Disc FULL, message 68  
 Disc Locked, message 68  
 Disc Transport buttons 9  
 DiscErr, message 68  
 Discs  
   buying 2

  how many songs 64  
   loading 13  
   title display 7  
   titling 20  
   write protect 68  
 Display  
   disc format indicators 6  
   marker indicators 7  
   MASTER indicator 6  
   MTC indicator 6  
   pitch indicator 6  
   repeat mode indicators 7  
   status indicators 6  
   stereo level meters 7  
   time counter 7  
   time counter modes 7  
   TOC EDIT indicator 6  
   track level meters 7  
   track record indicators 7  
 Display messages 68  
 Dividing a Song 45  
 Duplicating tracks 47

## E

Effects  
   applying 34  
   mixdown 34  
   ping-pong 35  
   recording 35  
 EJECT button 9  
 ELAPSE, time counter 7  
 ENTER button 9  
 EQ  
   beyond the basics 61  
   controls 4  
   response graph 4  
   specs 4  
 Erase Abort, message 68  
 Erase Warn!, message 68  
 Erasing  
   markers 39  
   songs 48  
   tracks 48  
 Error, message 68  
 EVEN, pan 14  
 EXE, definition 72

## F

Fader

input channel 4  
 master section 5  
 FF CUE button 9  
 First session 12  
 First track recording 13  
 FIX 6  
 Flow chart 69  
 Footswitch  
 auto punch in/out 27  
 connector 11  
 definition 72  
 operation table 33  
 punch in/out operation 23  
 Frame, definition 72

## G

GAIN control  
 about 4  
 setting 14  
 Group assign  
 AUX RETURN 5  
 input channels 4  
 STEREO SUB IN 5  
 GROUP ASSIGN switches 4  
 GROUP MONITOR SELECT  
 switches 5  
 Group, definition 72

## H

Headphone connector 11  
 Headphone volume control 5  
 HIGH EQ 4

## I

IN indicator 7  
 IN point setting 24  
 IN/OUT Err, message 68  
 Input channels  
 AUX control 4  
 EQ controls 4  
 fader 4  
 GAIN control 4  
 GROUP ASSIGN switches 4  
 Input source selector switch 4  
 PAN control 4  
 Inserting discs 13  
 Inserting markers 37

Invalid Song, message 68

## J

Joining songs 46

## L

LAST REC  
 search 36  
 SEARCH buttons 9  
 Level fader 4  
 Level meters  
 stereo outputs 7  
 tracks 7  
 Line-level signal, definition 72  
 Load Err, message 68  
 Load Warn !, message 68  
 loading a disc 13  
 LoadProhibit, message 68  
 LOW EQ 4  
 Low-level signal, definition 73

## M

Manual punch in/out 21  
 MARK button 9  
 MARK Failed, message 68  
 MARK SEARCH buttons 9  
 Markers  
 adjusting 38  
 beyond the basics 61  
 erasing 39  
 indicators 7, 37  
 inserting 37  
 searching 36  
 Master section  
 AUX RETURN GROUP  
 ASSIGN switches 5  
 AUX RETURN LEVEL control  
 5  
 CUE LEVEL controls 5  
 MONITOR LEVEL control 5  
 MONITOR SELECT switches  
 5  
 STEREO fader 5  
 STEREO SUB IN GROUP  
 ASSIGN switches 5  
 STEREO SUB IN LEVEL  
 control 5

MD DATA

buying discs 2  
 definition 73  
 disc indicators 6  
 disc life 64  
 titling discs 20

MD4

applications 57  
 as a sub mixer 59  
 block diagram 71  
 connectors 10  
 dimensions 71  
 discs 2  
 display 6  
 features 1  
 input channels 4  
 master section 5  
 MIDI 49  
 signal flow chart 69  
 specifications 70  
 topside view 3  
 touring 3  
 transport section 8  
 MEMO A/B buttons 8  
 Meter, Tempo Map 52  
 MIC/LINE  
 INPUT connectors 10  
 input source switch 4  
 MID EQ 4  
 MIDI  
 definition 73  
 home studio setup 58  
 implementation chart 79  
 MASTER indicator 6  
 MTC indicator 6  
 OUT connector 11  
 synchronization 49  
 MIDI Clock  
 definition 73  
 indicator 6  
 sequencer setting 52  
 system setup 50  
 using 52  
 MIDI Timecode *see* MTC  
 MiniDisc  
 definition 73  
 disc indicators 6  
 types 2  
 Mixdown  
 beyond the basics 63  
 definition 73  
 effects 34  
 operation 16  
 overview 17

**MONITOR**

- LEVEL control 5
- OUT connectors 10
- SELECT switches 5

**Monitoring**

- about 18
- beyond the basics 62
- overview 17

**MTC**

- cabling notes 51
- definition 73
- indicator 6
- sequencer setting 51
- system setup 50
- using 51

MTC OFF!, message 68

Multitrack recording overview 17

Multitracker, definition 73

**Multitracking**

- advanced 17
- basics 17

**N**

Naming discs & songs 20

New Record mode 67

New Record Pause mode 67

No Blank, message 68

No Disc, message 68

Nominal Level, definition 73

**O**

ODD, pan 14

OffLinePunch function 47

ON/OFF switch 11

One song repeat 40

One-take recording 57

OPEN, message 68

Opening the disc compartment 13

Operating level, definition 73

OUT indicator 7

Out point setting 24

**Overdubbing**

- definition 73
- operation 15
- overview 17
- with ping-pong 31

Overview of multitrack recording 17

**P**

PAN control 4

Panning, definition 73

PAUSE button 9

PB, input source switch 4

Phone jack, definition 73

PHONES connector 11

Phono jack, definition 73

**Ping-pong**

- about 29
- definition 74
- effects 35
- operation 30
- overview 17
- preparation 30
- rehearsing 30
- with simultaneous overdub 31

**Pitch**

- adjusting 32
- beyond the basics 62
- indicator 6
- resetting 32

PITCH button 8

PLAY button 9

Play Pause mode 67

Play Record Wait mode 67

Play Rehearse Wait mode 67

**Playback**

- cue list 42
- play 67
- program 43
- starting 9

PNCH Abort, message 68

Post fader, definition 74

POST indicator 7

Post-roll setting 28

**Power cord**

- connecting 13
- connector 11

POWER ON/OFF switch 11

Powering up MD4 13

PRE indicator 7

PrePost Roll 28

Pre-roll setting 28

PRG Play 43

Program playback 43

Project studio setup 58

Protecting MD4 recordings 64

**Punch in/out**

- manual operation 21
- overview 17
- using a footswitch 23
- using REC button 21

using REC SELECT buttons 22

PUNCH in/out connector 11

**Q**

Quick search functions 36

Quick-Start System 12

**R**

Random access, definition 74

Read Cancel, message 68

Reading TOC, message 68

REC button 9

Rec Mode 19

REC Prohibit, message 68

REC SELECT buttons 9

Record mode 67

Record Pause mode 67

**Recording**

- available time 19
- disc protection 64
- effects 35
- modes 19
- new song 19
- one-take 57
- operation 20
- overview 17
- ping-pong 29
- stereo source 60
- the first track 13
- track record indicators 7

REHE button 9

Rehearse Pause mode 67

**Rehearsing**

- auto punch 25
- mode 67
- ping-pong 30

REHEProhibit, message 68

Reload Disc, message 68

REMAIN, time counter 7

**Repeat**

- A–B 41
- all songs 40
- indicators 7
- one song 40

REPEAT 1 indicator 7

REPEAT ALL indicator 7

REPEAT button 8

REPEAT MEMO indicators 7

Resetting the pitch 32

REVIEW button 9  
Review mode 67

## S

Save Err, message 68  
Save Warn !, message 68  
SaveProhibit, message 68  
Searching  
  by time 36  
  for blank top 19  
  for last rec IN/OUT 36  
  for markers 36  
  for Songs 36  
SELECT buttons 8  
Setting  
  GAIN control 14  
  IN/OUT points 24  
  pitch 32  
  post-roll time 28  
  pre-roll time 28  
Signal flow chart 69  
Signal to noise ratio, definition 74  
Song Combine 46  
Song Copy 44  
Song Divide 45  
Song Erase 48  
Song Position Pointers, definition 73  
SONG SEARCH buttons 9  
Songs  
  combining 46  
  copying 44  
  dividing 45  
  erasing 48  
  how many on a disc 64  
  searching 36  
  title display 7  
  titling 20  
Specifications 70  
Splitting a song 45  
Status indicators 6  
STEREO fader 5  
Stereo level meters 7  
STEREO MONITOR SELECT switch 5  
STEREO OUT connectors 10  
Stereo source recording 60  
STEREO SUB IN  
  connecting 59  
  connectors 10  
  GROUP ASSIGN switches 5  
  LEVEL control 5

Stop 67  
STOP button 9  
SUB IN level control 5  
Sub mixer operation 59  
Switching on MD4 13  
Synchronization  
  operation 49  
  overview 17  
  system setup 50

## T

Tempo Map  
  about 49  
  chart 56  
  definition 74  
  deleting steps 54  
  inserting steps 54  
  loading 55  
  meter 52  
  saving 55  
  tempo 53  
Time counter 7  
Time counter modes 7  
TIME DISPLAY button 8  
Time search 36  
Titling discs & songs 20  
TOC  
  definition 74  
  updating 2  
TOC EDIT indicator 6  
TOC WRITE button 9  
Total, song count 13  
TOTAL, time counter 7  
TRACK DIRECT OUT connectors 10  
Track Erase function 48  
Tracking, definition 74  
Tracks  
  copying 47  
  erasing 48  
  level meters 7  
  record indicators 7  
Track-to-Track Copy 47  
Transport  
  ADJUST button 8  
  AUTO PUNCH I/O button 8  
  CLEAR button 9  
  DATA buttons 9  
  EJECT button 9  
  ENTER button 9  
  FF CUE button 9  
  LAST REC SEARCH buttons 9

MARK button 9  
MARK SEARCH buttons 9  
MEMO A/B buttons 8  
modes 67  
PAUSE button 9  
PITCH button 8  
PLAY button 9  
REC button 9  
REC SELECT buttons 9  
REHE button 9  
REPEAT button 8  
REVIEW button 9  
SELECT buttons 8  
SONG SEARCH buttons 9  
STOP button 9  
TIME DISPLAY button 8  
TOC WRITE button 9  
UTILITY button 8  
Turning on MD4 13

## U

Unity gain, definition 74  
Updating the TOC 2  
UTILITY button 8  
UTILITY functions  
  Cue List 42  
  MIDI Sync 49  
  OffLinePunch 47  
  PrePost Roll function 28  
  PRG Play function 43  
  Rec Mode function 19  
  Song Combine 46  
  Song Copy 44  
  Song Divide 45  
  Song Erase 48  
  Track Erase 48  
UTOOC FULL, message 68

## V

VARI 6  
Varying the pitch 32

## W

Write Protect, message 68  
Writing TOC, message 68

## MIDI Implementation Chart

Function...		Transmitted	Recognized	Remarks
Basic Channel	Default Changed	X X	X X	
Mode	Default Messages Altered	X X *****	X X X	
Note Number	True Voice	X *****	X X	
Velocity	Note On Note Off	X X	X X	
After Touch	Keys Ch's	X X	X X	
Pitch bend		X	X	
Control Change		X	X	
Prog Change	:True#	X *****	X X	
System Exclusive		X	X	
System Common	:Song Pos :Song Sel :Tune	O X X	X X X	
System Real Time	:Clock :Commands	O O	X X	
Aux Messages	:Local ON/OFF :All Notes OFF :Active Sense :Reset	X X X X	X X X X	
Notes	MTC quarter frame message is transmitted			

### Mixer Setup

Source:	Source:	Source:	Source:
1	2	3	4

### Track List

1	2	3	4

### Cue List

Step	Section	Repeat	Title
1	→		
2	→		
3	→		
4	→		
5	→		
6	→		
7	→		
8	→		
9	→		

### Session Info

Title: \_\_\_\_\_

Date: \_\_\_\_\_

Step: \_\_\_\_\_

Process: \_\_\_\_\_

Notes: \_\_\_\_\_

# MOL Tracking Sheet

### Marker Log

S	1	2	3	4	5	6	7	8	E
---	---	---	---	---	---	---	---	---	---