

YAMAHA

POWER AMPLIFIER
AMPLIFICATEUR DE PUISSANCE
ENDSTUFE

PC3000A

OPERATION MANUAL
MODE D'EMPLOI
BEDIENUNGSANLEITUNG

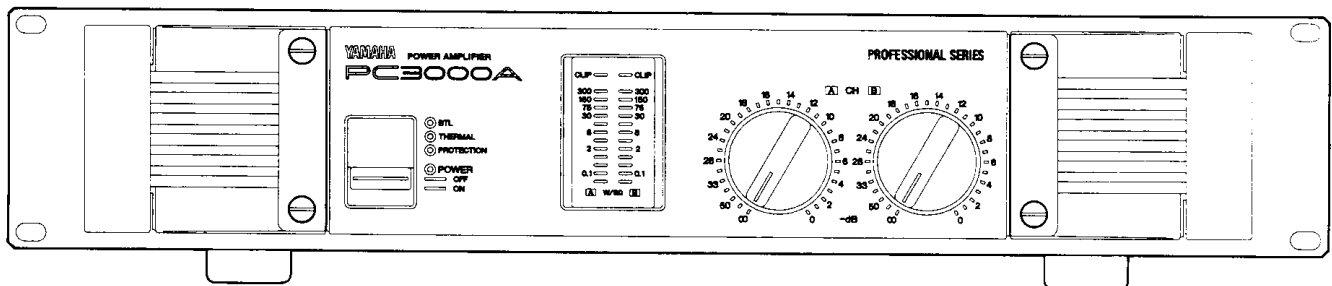

Dette apparat overholder det gældende EF-direktiv vedrørende radiostøj.

Cet appareil est conforme aux prescriptions de la directive communautaire 87/308/CEE.

Diese Geräte entsprechen der EG-Richtlinie 82/499/EWG und/oder 87/308/EWG.

This product complies with the radio frequency interference requirements of the Council Directive 82/499/EEC and/or 87/308/EEC.

Questo apparecchio è conforme al D.M.13 aprile 1989 (Direttiva CEE/87/308) sulla soppressione dei radiodisturbi.

Este producto está de acuerdo con los requisitos sobre interferencias de radio frecuencia fijados por el Consejo Directivo 87/308/CEE.

YAMAHA CORPORATION

IMPORTANT NOTICE FOR THE UNITED KINGDOM

Connecting the Plug and Cord

IMPORTANT. The wires in this mains lead are coloured in accordance with the following code:

BLUE : NEUTRAL
BROWN : LIVE

As the colours of the wires in the mains lead of this apparatus may not correspond with the coloured markings identifying the terminals in your plug proceed as follows:

The wire which is coloured BLUE must be connected to the terminal which is marked with the letter N or coloured BLACK.

The wire which is coloured BROWN must be connected to the terminal which is marked with the letter L or coloured RED.

Making sure that neither core is connected to the earth terminal of the three pin plug.

* This applies only to products distributed by YAMAHA - KEMBLE MUSIC (U.K.) LTD.

Thank you for purchasing the Yamaha PC3000A Power Amplifier. The PC3000A is a fine example of the experience and skill Yamaha has developed for the production of superior audio and PA equipment. The PC3000A Power Amplifier not only has high power and high quality, but is highly reliable and stable as well. The small design and continuous power output (330W + 330W for stereo 8 ohm loads and 900W for monaural 8 ohm loads) ensure convenient, high-powered performance in any application.

In addition to the powerful amplification capability of the PC3000A, safe operation is assured through extensive protection circuitry: an automatic fan provides variable rate cooling depending on the internal temperature of the amplifier; DC detection circuitry continuously monitors for harmful DC voltages in the power output; a PC limiter circuit prevents excessive power output levels and signal distortion; and a POWER ON MUTE protects valuable speakers.

Read this operation manual thoroughly in order to take full advantage of the PC3000A's performance capabilities and to ensure continued enjoyment in years to come.

CONTENTS

PRECAUTIONS	2
OPERATION	3
INSTALLATION DETAILS	6
CAUTION FOR SPEAKER CONNECTION	8
CLEANING THE FILTER ELEMENTS	9
TROUBLESHOOTING	9
SPECIFICATIONS	10
PERFORMANCE GRAPHS	11
BLOCK DIAGRAM	12
DIMENSIONS	13

PRECAUTIONS

1. Avoid Excessive Heat, Humidity, Dust and Vibration

Keep the unit away from locations where it is likely to be exposed to high temperatures or humidity — such as near radiators, stoves, etc. Also avoid locations which are subject to excessive dust accumulation or vibration which could cause mechanical damage.

2. Amplifier Ventilation

The power amplifier is equipped with cooling fans. It is important to ensure that proper air flow can be maintained. Position the amplifier so that the front and rear ventilation airflow paths are not blocked. For details about rack mount ventilation, refer to the “INSTALLATION DETAILS” section on page 6.

3. Air Filter Maintenance

This unit uses two fans for taking in cool air from the outside. To prevent dust from penetrating the interior, the air inlets are equipped with filters. When the filter elements becomes clogged, the cooling efficiency will be impaired. For this reason, the filter elements should be checked periodically, and rinsed if necessary. For details, refer to page 9, “CLEANING THE FILTER ELEMENTS”.

4. Avoid Physical Shocks

Strong physical shocks to the unit can cause damage. Handle it with care.

5. Do Not Open The Case Or Attempt Repairs Or Modifications Yourself

This product contains no user-serviceable parts. Refer all maintenance to qualified Yamaha service personnel. Opening the case and/or tampering with the internal circuitry will void the warranty.

6. Make Sure Power Is Off Before Making Or Removing Connections

Always turn the power OFF prior to connecting or disconnecting cables. This is important to prevent damage to the unit itself as well as other connected equipment.

7. Handle Cables Carefully

Always plug and unplug cables — including the AC cord — by gripping the connector, not the cord.

8. Clean With a Soft Dry Cloth

Never use solvents such as benzine or thinner to clean the unit. Wipe clean with a soft, dry cloth.

9. Always Use the Correct Power Supply

Make sure that the power supply voltage specified on the rear panel matches your local AC mains supply. Also make sure that the AC mains supply can deliver more than enough current to handle all equipment used in your system.

OPERATION

FRONT PANEL

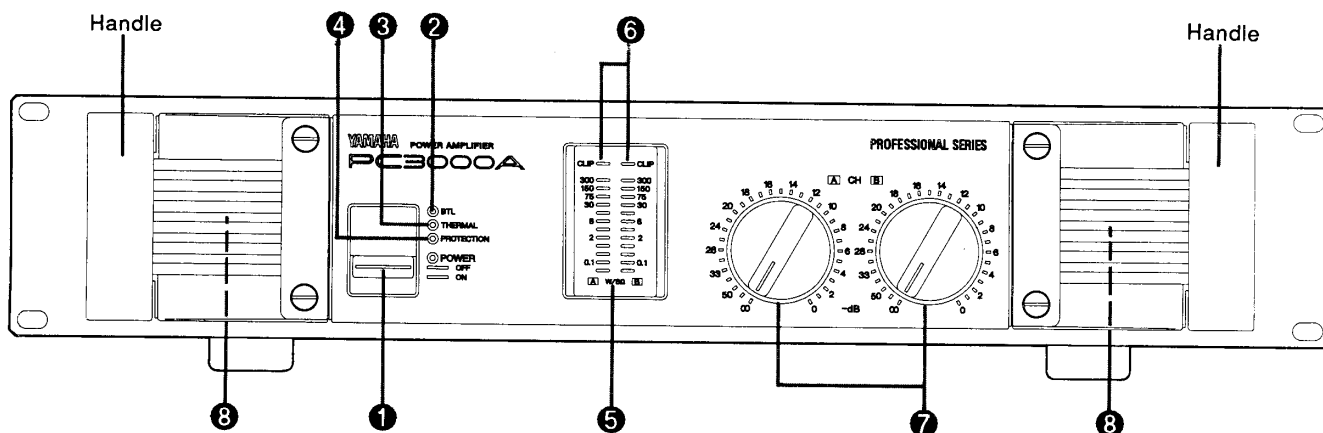

1 POWER Switch & Indicator

Pressing this switch turns the power ON, and pressing again turns the power OFF. The indicator lights when the power is ON.

2 BTL Indicator

The BTL indicator will be lit when the amplifier is operating in monaural (BTL) and the rear panel MODE switch has been set to MONO.

3 THERMAL Indicator

When the heat sink temperature exceeds 80 degC, the cooling fan will operate at high speed and the thermal indicator will light. If the indicator remains lit for a long time, check for cooling problems such as blocked air vents. For proper ventilation details, refer to the "Installation Details" on page 6.

4 PROTECTION Indicator

The PROTECTION indicator lights for approximately 6 seconds after the POWER switch is pressed to indicate that the protection circuitry is operating. No sound is output from the speakers while this indicator is lit. This indicator will also light and sound will be cut off to the speakers if the protection circuitry is activated at any other time during amplifier operation due to factors such as overheating or the detection of excessive DC voltage at the outputs. When the problem is corrected, the protection circuitry is automatically deactivated, the indicator goes out, and the amplifier resumes normal operation.

5 OUTPUT Level Meter

The amplifier power output level is indicated by a 12 point LED display. When the speaker impedance is 8 ohms, the power level is indicated directly. However, when speaker impedance is 4 ohms, the actual power output level is double the value indicated by the LED meter.

6 CLIP Indicators

The CLIP indicators light if the output distortion exceeds approximately 1%. These indicators, which are independently provided for each channel, indicate that an excessively large input signal is being applied to the amplifier causing clipping to occur.

7 Input Attenuators

The input attenuators are 31-position click-stop controls used for adjusting input sensitivity. The sensitivity can be set from 0 dB to -20 dB in 1 dB increments. Rotating fully in the clockwise direction sets the attenuator at 0 dB, while rotating fully in the counterclockwise direction provides infinite attenuation.

8 Cooling Fans

The amplifier is cooled with a variable rate, cooling fans.

When there is no output signal, or when the heat sink temperature is low, the fan is stopped. When the heat sink temperature exceeds 60 degC, the fan will begin to rotate. The fan speed will increase as the heat sink temperature increases.

9 Knob Locks (supplied)

Push these locks over the attenuation controls to prevent accidental resetting of the levels. Pull them off again if you need to reset the levels.

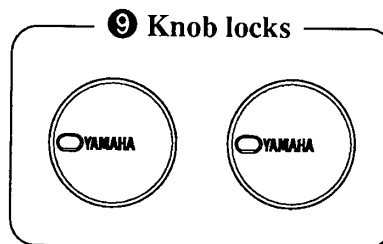

REAR PANEL

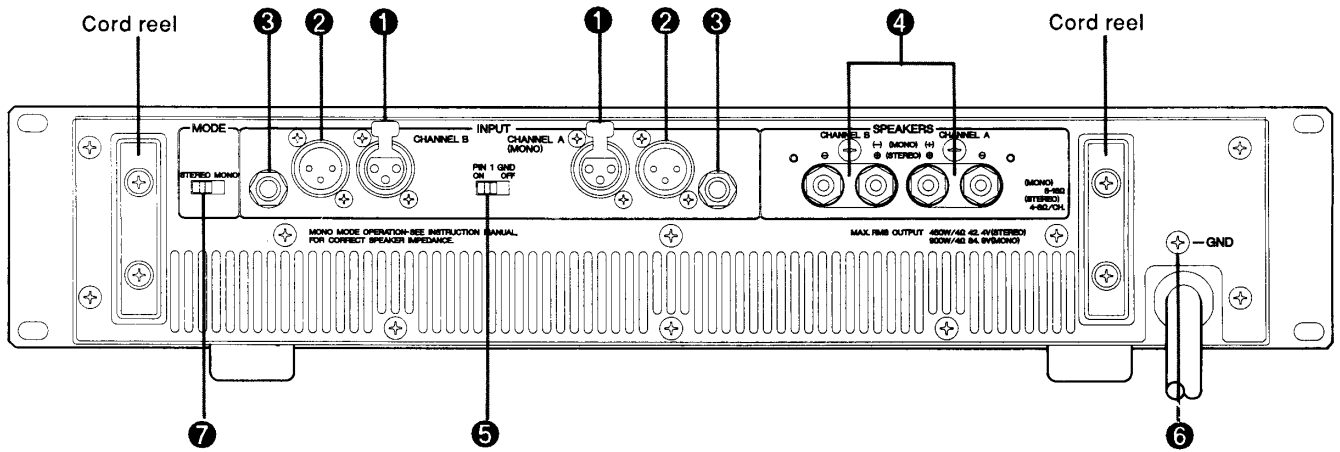

U.S. model

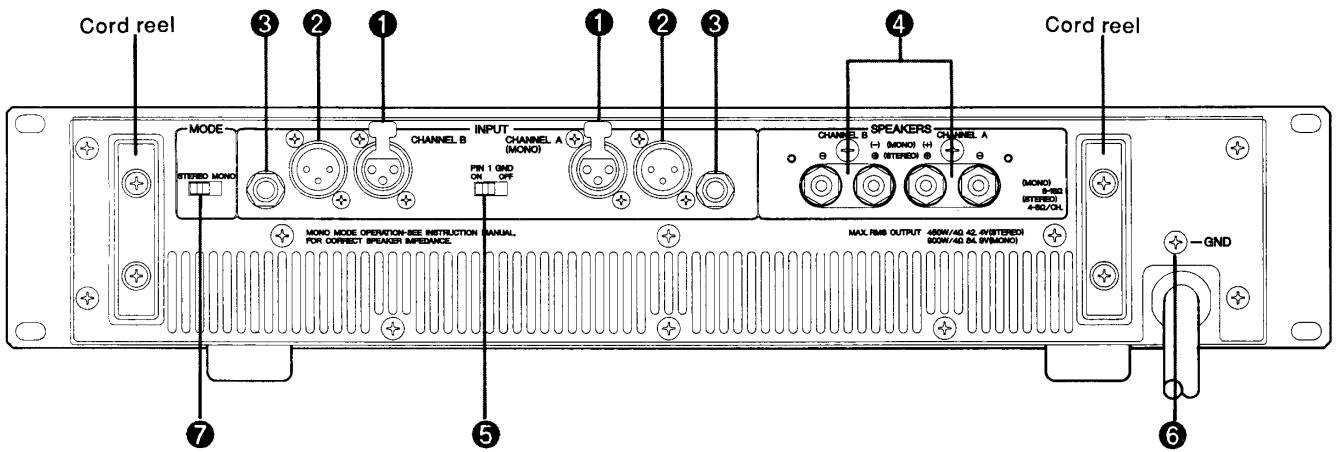

Canadian model

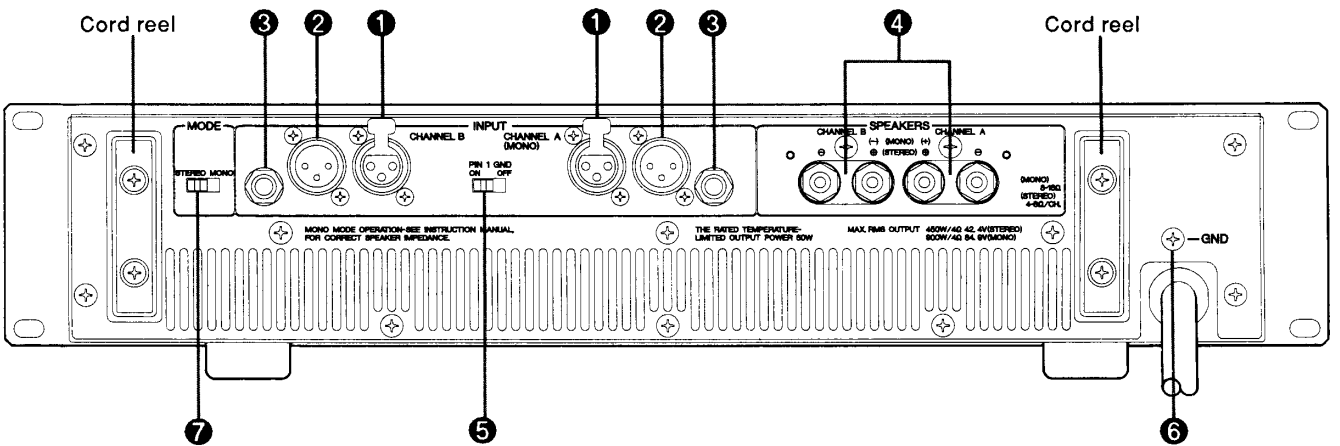

General model

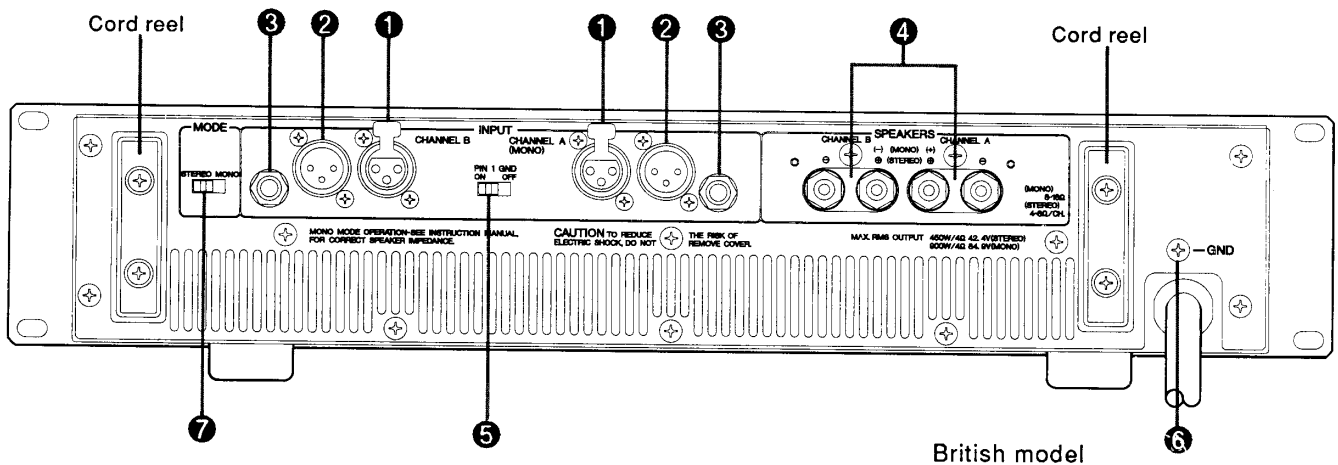

British model

1 INPUT Connectors (XLR-3-31 type)

These are balanced XLR-3-31 type connectors. Generally, XLR-3-31 type connectors are used as the standard for inputs. The pin-out conforms to IEC specifications as follows: Pin 1 = Shield (ground); Pin 2 = Hot; Pin 3 = Cold. Compatible connectors include the Cannon XLR-3-12C and Switchcraft 5C-1055A.

2 INPUT Connectors (XLR-3-32 type)

These are balanced XLR-3-32 type connectors. Compatible connectors include the Cannon XLR-3-11C and Switchcraft 5C-1055A. These connectors are convenient for retransmitting the input signal to other power amplifiers.

3 INPUT Connectors (TRS Phone type)

These 1/4-inch balanced TRS connectors accept balanced and unbalanced input signals.
Tip=hot, Ring=cold, Sleeve=ground.

4 SPEAKER Terminals

These are used for connecting the speakers. The red terminal is connected to the speaker's "+" connector and the black terminal is connected to the "-" connector.

Refer to page 8 for details on speaker connection.

5 GND Switch

The GND Switch connects or isolates the Cannon connector earth line (XLR Pin 1: Shield) with the chassis. This switch is usually left ON, but if a "hum" develops in the earth line loop, it is necessary to turn the switch OFF to interrupt the loop and reduce the hum.

6 GND Terminal

The GND terminal is used to make a physical connection to earth. In cases of hum or other abnormal noise, connect the GND terminal to the chassis of a mixer or pre-amplifier.

7 MODE Switch

This switch sets the amplifier for stereo or monaural operation. Make sure the switch is correctly set for the mode in which the amplifier is to operated.

— Monaural (BTL) Connection —

Although the PC3000A is normally used as a stereo amplifier with two independent input and output channels A and B, it is possible to combine the two channels to transform the amplifier into a BTL-connected monaural power amplifier.

— Monaural Operation —

- 1) Turn the POWER switch OFF.
- 2) Set the rear panel MODE switch to MONO.
- 3) Connect the channel A input connector to the signal input source. (The channel B input connector cannot be used.)
- 4) Adjust the input level with the channel A input attenuator.
- 5) Connect the "+" speaker lead to the "+" speaker terminal of channel A, and connect the "-" speaker lead to the "+" speaker terminal of channel B. The "-" speaker terminals on the amplifier are not used.

Note: Use speakers with an impedance of 8 ohms or greater.

INSTALLATION DETAILS

Make sure that the amplifier has adequate ventilation. The unit is equipped with a twin fan cooling system. For this reason the airflow to the front and rear panels should not be blocked.

■ Permanent Rack Mounting

When high-powered amplifiers are rack mounted, the heat generated from each amplifier can build up inside the rack causing excessive temperatures. This is especially true if there is no rear opening in the rack mount enclosure. To lower the interior temperature, it is necessary to improve the ventilation of the rack mount. Since warm air rises to the top of the rack mount, cooling will be most effective if air can be expelled from the top directly.

1. When the amplifier is rack mounted, sufficient ventilation to the inside of the rack must be provided. For best ventilation results, the rear of the rack should be kept fully open. If a rear panel must be installed, it will be necessary to provide one 1U-size blank panel with ventilation slots for every four amplifiers at the uppermost installation space in the front or rear panel of the rack. (See Figure 1.) The optional Yamaha VP1 Ventilation Panel is recommended for use as a blank panel.
2. Make sure that a space of at least 100 mm exists between the power amplifier's rear panel and the rear of the rack.
3. Place the rack in a well-ventilated location.
4. When a power amplifier is mounted in a rack with other types of components, be careful that the heat generated by the power amplifier does not affect the other components.

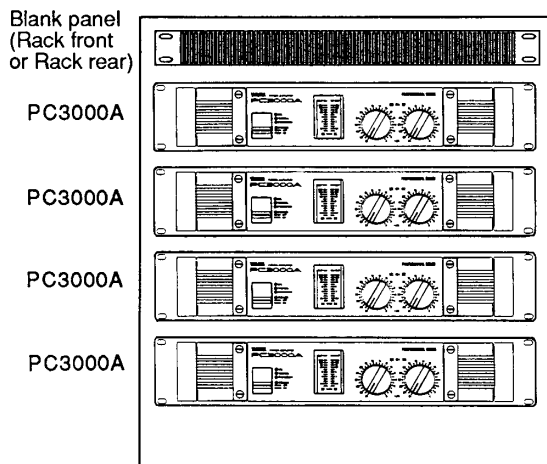

Ventilated Panel

Yamaha VP1 ventilation panel may be provided as an optional accessory (open area should be at least 35% of total area).

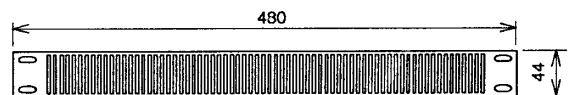

unit: mm

Fig. 1; Rack mounting with ventilated panel

■ Portable Rack Mounting

The amplifier intakes cool air through the front panel and exhausts warm air out the rear panel. When mounting amplifiers in a portable rack, make sure the rear panel is completely open for ventilation.

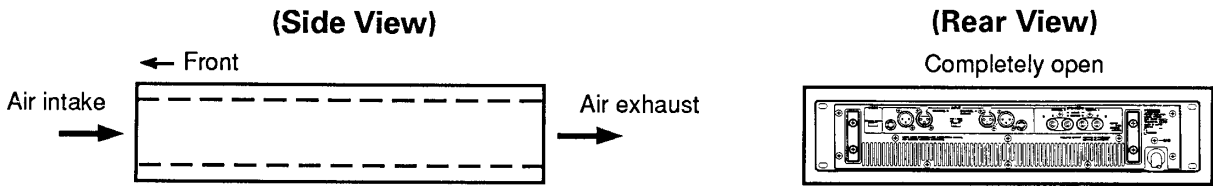

■ Positioning the housed amplifier

Place the case so that the ventilation airflow paths are not blocked.

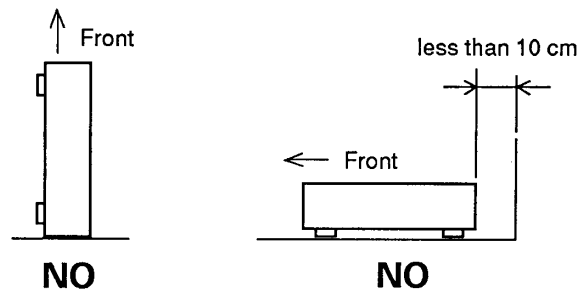

■ Rear support

▲ Screw holes are provided in the rear of the amplifier for use in supporting the rear of the amplifier.

* See the dimensions (page 13) for screw hole positions.

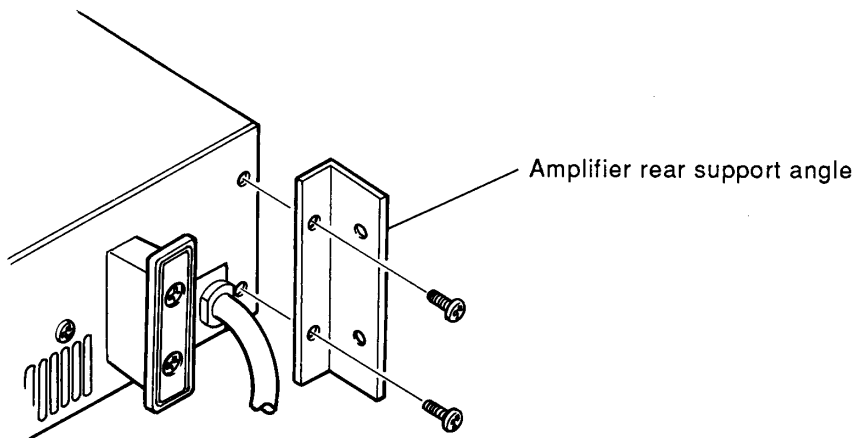

CAUTION FOR SPEAKER CONNECTION

1. Turn off the POWER switch.
2. Remove the cover attachment screws and remove the protective cover from the speaker terminals.
* The protective cover is equipped with British model and general model.

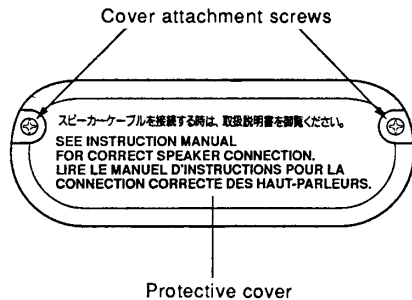

3. After removing approx. 10 mm of covering insulation from the ends of the speaker cables, pass the bare ends of the speaker wires through the holes in the corresponding speaker terminals and tighten the terminals to securely clamp the wires.

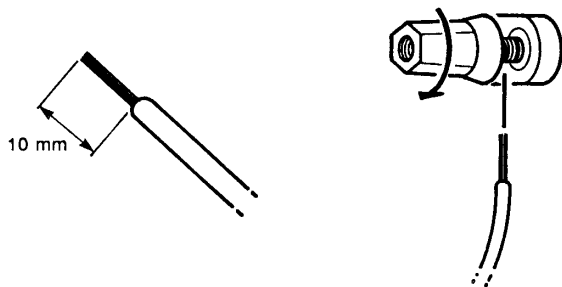

At this time make sure that the bare ends of the speaker cables do not extend from the terminals in such a way that they touch the chassis or protective cover.

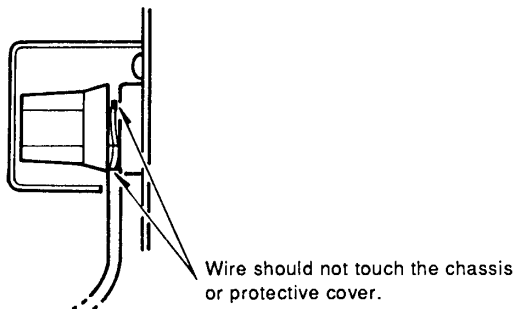

4. Reattach the protective cover over the speaker terminals.

— Speaker output terminals —

Connect the amplifier's A channel and B channel speaker terminals to the corresponding speakers. Make sure that the red terminals on the amplifier are connected to the "+" terminals on the speakers, and that the black terminals are connected to the "-" terminals on the speakers.

Take care that the end of each speaker cable does not short with another end of the speaker cable or with the chassis or protective cover, and then secure the wire in place by tightening down the terminal. Also, always make sure that the power is OFF before attaching or removing speaker wires.

- If long speaker cables are required, use cables with as heavy a gauge as possible to protect against degradation caused by the damping factor and to prevent power loss inside the speaker cables.
- Since PC3000A can provide a high power output of up to 330 W + 330 W with 8 ohm load when operating as a stereo amplifier, and up to 900 W with 8 ohm load when operating as a monaural amplifier, it is necessary to use a speaker system with sufficient power handling capabilities. If the allowable input power of the speaker system is lower than the rated output power of the amplifier, you can protect the speakers by connecting an in-line fuse between each speaker and the amplifier.

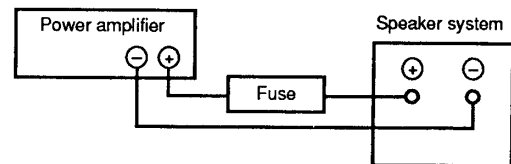

- * You can use the following formula to determine the size of fuse needed for your system.

$$P_o = I^2 R \rightarrow I = \sqrt{\frac{P_o}{R}}$$

P_o : Continuous allowable input power of speaker (noise or RMS)

R : Nominal impedance of speaker

I : Necessary fuse capacity (A)

Example: Speaker continuous allowable input power ; 100 W
Speaker impedance ; 8 ohm
Using these values.

$$I = \sqrt{\frac{100}{8}} = 3.5$$

Necessary fuse capacity (A) = 3.5

CLEANING THE FILTER ELEMENTS

To ensure adequate cooling air intake, the filter element must be cleaned when it has become clogged. The following points describe the cleaning procedure:

1. Make sure the power to the amplifier is OFF.
2. Remove the power plug from the AC mains socket.
3. Remove the two stoppers that secure the front filter grilles to the amplifier.
4. Remove the filter elements, and wash in plain water. If the filter elements are exceptionally dirty, detergent (washing-up liquid) may be used.
5. Dry the filter elements thoroughly.
NEVER REPLACE THE FILTER ELEMENTS WHILE THEY ARE STILL WET!
 Replace the elements and front filter grilles. (The replacement part number of the filter element is VL86960.)

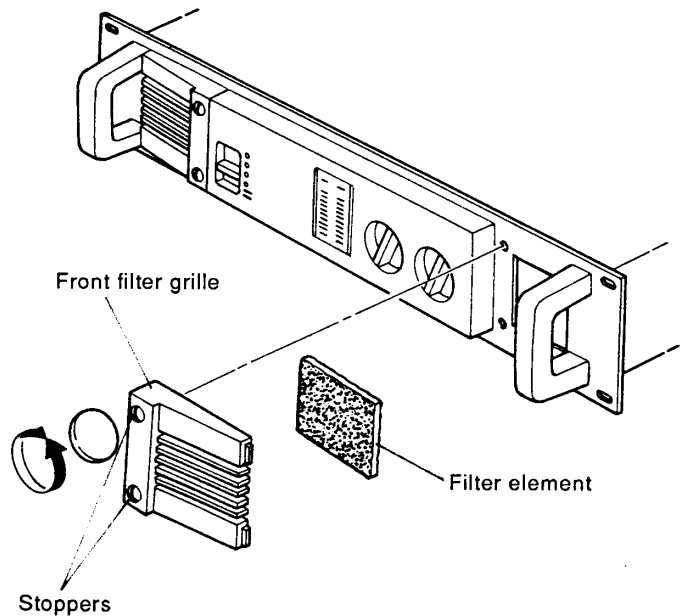

TROUBLESHOOTING

The following table lists the main causes of abnormal operation and the corrective measures required, as well as the protective circuit operation in each case.

Indicator display	Probable cause	Remedy	Protective circuit operation
CLIP indicator lights.	There is a short at a speaker terminal, amplifier terminal, or wire.	Locate and correct the cause of the short.	The PC limiter circuit operates to protect the power transistors.
	The amplifier load is excessive.	Use a speaker system with an impedance of at least 4 ohms (stereo) or 8 ohms (monaural).	Same as above.
PROTECTION indicator lights.	The heat sink temperature has exceeded 100°C.	Check the amplifier ventilation conditions and take appropriate measures to improve airflow around the amplifier.	The thermal protection circuit operates to protect the power transistors.
	A DC voltage of +/-2V or greater was generated in the power amplifier's output circuit.	Consult your dealer or nearest Yamaha service center.	The relay operates to protect the speaker system.

SPECIFICATIONS

POWER OUTPUT LEVEL

STEREO:

330W + 330W; RL = 8 ohms, f = 20 Hz — 20 kHz, THD \leq 0.1 %
450W + 450W; RL = 4 ohms, f = 20 Hz — 20 kHz, THD \leq 0.1 %

MONO:

900W; RL = 8 ohms, f = 20 Hz — 20 kHz, THD \leq 0.1 %

FREQUENCY RESPONSE

0 dB +0,-1 dB; f = 10 Hz — 50 kHz, RL = 8 ohms, Po = 1 W

POWER BANDWIDTH

STEREO:

10 Hz — 40 kHz; Po = 165 W, RL = 8 ohms, THD = 0.1 %
10 Hz — 40 kHz; Po = 225 W, RL = 4 ohms, THD = 0.1 %

MONO:

10 Hz — 40 kHz; Po = 450 W, RL = 8 ohms, THD = 0.1 %

TOTAL HARMONIC DISTORTION (THD)

STEREO:

\leq 0.02%; Po = 165 W, RL = 8 ohms, f = 20 Hz — 20 kHz
 \leq 0.03%; Po = 225 W, RL = 4 ohms, f = 20 Hz — 20 kHz

MONO:

\leq 0.03%; Po = 450 W, RL = 8 ohms, f = 20 Hz — 20 kHz

INTERMODULATION DISTORTION (IMD)

STEREO:

\leq 0.01%; Po = 165 W, RL = 8 ohms, f = 60 Hz : 7 kHz, 4 : 1
 \leq 0.01%; Po = 225 W, RL = 4 ohms, f = 60 Hz : 7 kHz, 4 : 1

MONO:

\leq 0.01%; Po = 450 W, RL = 8 ohms, f = 60 Hz : 7 kHz, 4 : 1

CHANNEL SEPARATION

ATT max, Input 600 ohms shunt

\geq 70 dB; Po = 165 W, RL = 8 ohms, f = 20 Hz — 20 kHz
 \geq 85 dB; Po = 165 W, RL = 8 ohms, f = 1 kHz

RESIDUAL NOISE

\leq -75 dBm; ATT min, fc = 12.7 kHz -6 dB/oct LPF
 \leq -80 dBm; ATT min, IHF-A network

SIGNAL-TO-NOISE RATIO

\geq 104 dB; Input 600 ohms shunt, fc = 12.7 kHz -6 dB/oct LPF
 \geq 106 dB; Input 600 ohms shunt, IHF-A network

DAMPING FACTOR

$>$ 200; RL = 8 ohms, f = 1 kHz

SLEW RATE

\pm 50 V/ μ sec; Stereo, RL = 8 ohms, Full Swing
 \pm 60 V/ μ sec; Mono, RL = 8 ohms, Full Swing

SENSITIVITY

+ 4 dBm; Po = 330 W, 8 ohms, ATT max, f = 1 kHz

VOLTAGE GAIN

32.5 dB; ATT max, f = 1 kHz, RL = 8 ohms

INPUT IMPEDANCE

\geq 13 kohms; Balance or Unbalance, ATT max

INDICATORS

POWER (Red)	turns on when Power is On
BTL (Green)	turns on when MODE switch is "MONO"
THERMAL (Red)	turns on when Fan Speed is "HIGH"
PROTECTION (Red)	turns on when protection or muting is On
CLIP (Red)	turns on when THD \geq 1 %
LED Power Meter	12 point

PROTECTION CIRCUITS

OUTPUT MUTING	6 sec. \pm 2 sec.; after power is on
DC sense	DC \pm 2 V; output shut off
THERMAL	\geq 100 degree C.; heat sink temp.
PC LIMITER	RL \leq 1 ohms

CONTROLS

FRONT

POWER switch ; push on/ push off
INPUT attenuator; 31-position

REAR

MODE switch ;Stereo/Mono (BTL)
PIN-1 GND switch; on/off

POWER REQUIREMENTS

U.S. & Canadian Models; 120 V, 60 Hz
British Model; 240 V, 50/60 Hz
General Model; 230 V, 50/60 Hz

POWER CONSUMPTION

U.S. Model; 1000 W
Canadian Model; 1000 W/1100 VA
British Model; 1000 W
General Model; 1000 W

DIMENSIONS (W x H x D)

480 x 100 x 464.2 mm (18-7/8" x 3-15/16" x 18-1/4")

WEIGHT

19.5 kg (43 lbs.)

* 0 dB = 0.775 Vr.m.s.

* Specifications and appearance subject to change without notice.

PERFORMANCE GRAPHS

FREQUENCY RESPONSE

Load Impedance: 8Ω
 Input Attenuators: Max
 Mode: STEREO

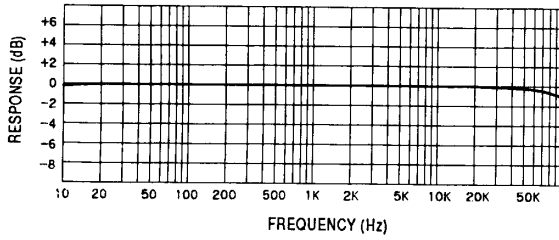

CHANNEL SEPARATION

Load Impedance: 8Ω
 0 dB = 165W
 Measuring Channel
 Input 600Ω Shunt, ATT. Max.

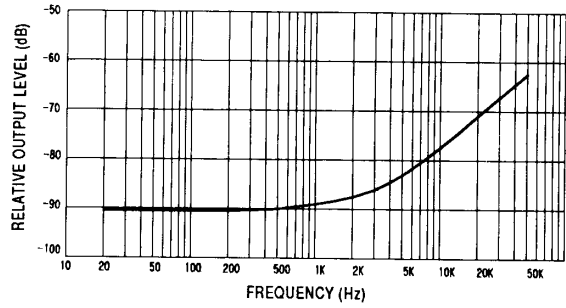

THD vs OUTPUT POWER

Load Impedance: 8Ω
 Mode: STEREO
 Both Channels Driven

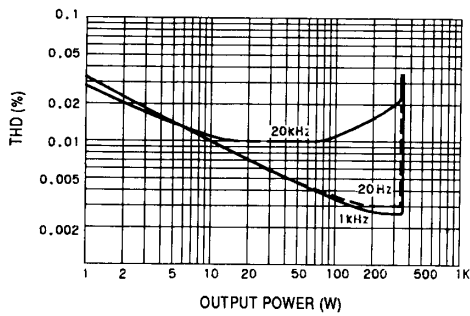

DAMPING FACTOR

Load Impedance: 8Ω

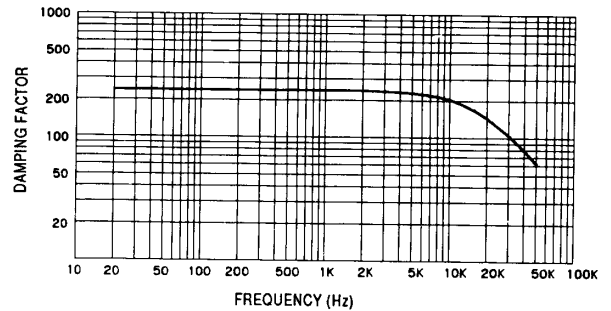

THD vs OUTPUT POWER

Load Impedance: 8Ω
 Mode: MONO (BTL)

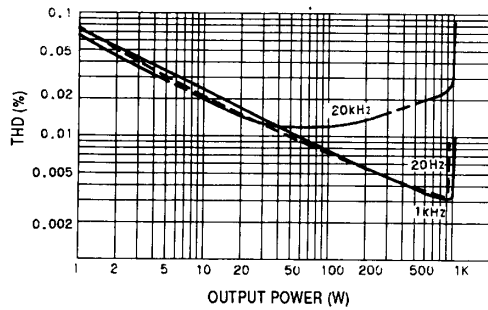

OUTPUT POWER vs POWER CONSUMPTION

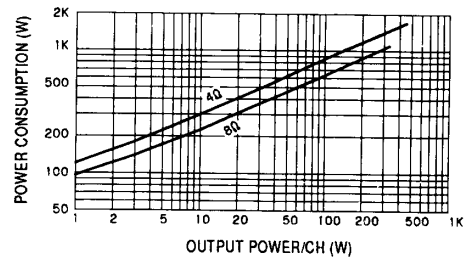

THD vs FREQUENCY

Load Impedance: 8Ω
 Mode: STEREO
 Both Channels Driven
 Output Power: 165W constant

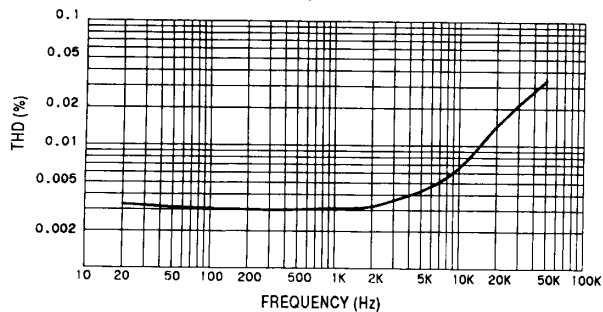

BLOCK DIAGRAM

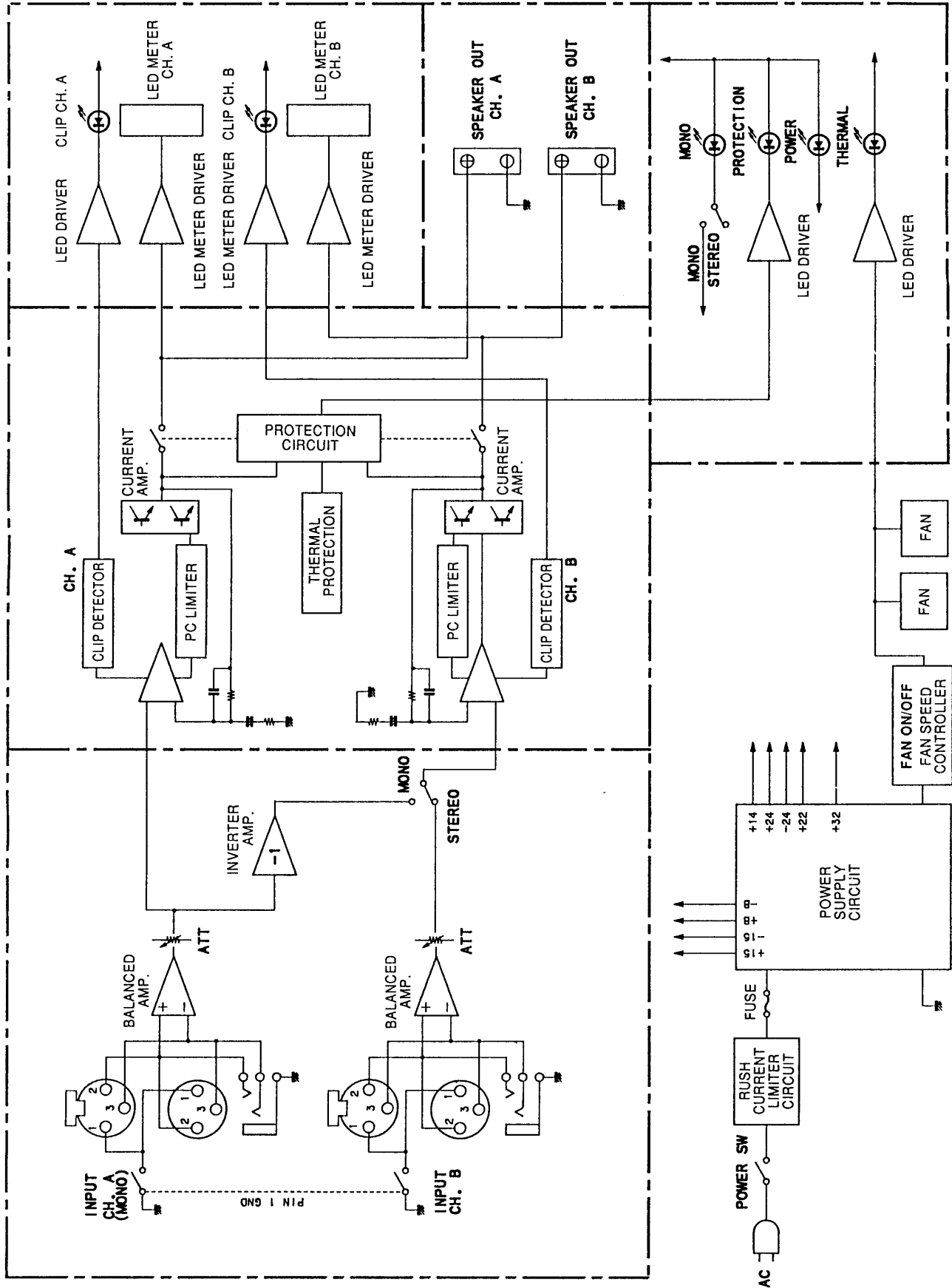

CAUTION

The power switch does not disconnect the complete apparatus from the mains line.

ATTENTION

L'appareil reste toujours sous tension lorsque la touche secteur est en position arrêt.

ACHTUNG

Das Gerät steht auch bei der Netzschalter-Stellung "Aus" noch unter Spannung.

OBSERVERA

Apparaten kopplas inte bort från växelströmskällan (nätet) så länge som den är ansluten till vägguttaget, även om själva apparaten har stängts av.

ADVARSEL

Netspændingen til dette apparat er IKKE afbrudt, så længe netledningen sidder i en stikkontakt, som er t endt - også selvom der er slukket på apparatets afbryder.

VAROITUS

Laitteen toisiopiiriin kytketty käyttökytkin ei irroita koko laitetta verkosta.

AVVERTENZA

L'apparecchio rimane sotto tensione anche quando è spento tramite l'interuttore principale.

SERVICE

This product is supported by YAMAHA's worldwide network of factory trained and qualified dealer service personnel. In the event of a problem, contact your nearest YAMAHA dealer.

ENTRETIEN

L'entretien de cet appareil est assuré par le réseau mondial YAMAHA de personnel d'entretien qualifié et formé en usine des concessionnaires. En cas de problème, prendre contact avec le concessionnaire YAMAHA le plus proche.

KUNDENDIENST

Für dieses Gerät steht das weltweite YAMAHA Kundendienstnetz mit qualifiziertem, werksgeschultem Personal zur Verfügung. Bei Störungen und Problemen wenden Sie sich bitte an Ihren YAMAHA-Händler.

YAMAHA

YAMAHA CORPORATION
P.O.Box 1, Hamamatsu, Japan