



# DTXTREME II S

DRUM TRIGGER MODULE

## OWNER'S MANUAL



# SPECIAL MESSAGE SECTION

This product utilizes batteries or an external power supply (adapter). DO NOT connect this product to any power supply or adapter other than one described in the manual, on the name plate, or specifically recommended by Yamaha.

## **WARNING:**

Do not place this product in a position where anyone could walk on, trip over, or roll anything over power or connecting cords of any kind. The use of an extension cord is not recommended! IF you must use an extension cord, the minimum wire size for a 25' cord (or less) is 18 AWG. NOTE: The smaller the AWG number, the larger the current handling capacity. For longer extension cords, consult a local electrician.

This product should be used only with the components supplied or; a cart, rack, or stand that is recommended by Yamaha. If a cart, etc., is used, please observe all safety markings and instructions that accompany the accessory product.

## **SPECIFICATIONS SUBJECT TO CHANGE:**

The information contained in this manual is believed to be correct at the time of printing. However, Yamaha reserves the right to change or modify any of the specifications without notice or obligation to update existing units.

This product, either alone or in combination with an amplifier and headphones or speaker/s, may be capable of producing sound levels that could cause permanent hearing loss. DO NOT operate for long periods of time at a high volume level or at a level that is uncomfortable. If you experience any hearing loss or ringing in the ears, you should consult an audiologist.

**IMPORTANT:** The louder the sound, the shorter the time period before damage occurs.

Some Yamaha products may have benches and / or accessory mounting fixtures that are either supplied with the product or as optional accessories. Some of these items are designed to be dealer assembled or installed. Please make sure that benches are stable and any optional fixtures (where applicable) are well secured BEFORE using. Benches supplied by Yamaha are designed for seating only. No other uses are recommended.

## **NOTICE:**

Service charges incurred due to a lack of knowledge relating to how a function or effect works (when the unit is operating as designed) are not covered by the manufacturer's warranty, and are therefore the owners responsibility. Please study this manual carefully and consult your dealer before requesting service.

## **ENVIRONMENTAL ISSUES:**

Yamaha strives to produce products that are both user safe and environmentally friendly. We sincerely believe that our products and the production methods used to produce them, meet these goals. In keeping with both the letter and the spirit of the law, we want you to be aware of the following:

## **Battery Notice:**

This product MAY contain a small non-rechargeable battery which (if applicable) is soldered in place. The average life span of this type of battery is approximately five years. When replacement becomes necessary, contact a qualified service representative to perform the replacement.

This product may also use "household" type batteries. Some of these may be rechargeable. Make sure that the battery being charged is a rechargeable type and that the charger is intended for the battery being charged.

When installing batteries, do not mix batteries with new, or with batteries of a different type. Batteries MUST be installed correctly. Mismatches or incorrect installation may result in overheating and battery case rupture.

## **Warning:**

Do not attempt to disassemble, or incinerate any battery. Keep all batteries away from children. Dispose of used batteries promptly and as regulated by the laws in your area. Note: Check with any retailer of household type batteries in your area for battery disposal information.

## **Disposal Notice:**

Should this product become damaged beyond repair, or for some reason its useful life is considered to be at an end, please observe all local, state, and federal regulations that relate to the disposal of products that contain lead, batteries, plastics, etc. If your dealer is unable to assist you, please contact Yamaha directly.

## **NAME PLATE LOCATION:**

The name plate is located on the bottom panel of the product. The name plate lists the product's model number, power requirements, and other information. The serial number is located on the bottom panel. Please record the model number, serial number, and date of purchase in the spaces provided below, and keep this manual as a permanent record of your purchase.

**Model**

---

**Serial No.**

---

**Purchase Date**

---

# PLEASE KEEP THIS MANUAL

## FCC INFORMATION (U.S.A.)

### 1. IMPORTANT NOTICE: DO NOT MODIFY THIS UNIT!

This product, when installed as indicated in the instructions contained in this manual, meets FCC requirements. Modifications not expressly approved by Yamaha may void your authority, granted by the FCC, to use the product.

### 2. IMPORTANT:

When connecting this product to accessories and/or another product use only high quality shielded cables. Cable/s supplied with this product MUST be used. Follow all installation instructions. Failure to follow instructions could void your FCC authorization to use this product in the USA.

### 3. NOTE:

This product has been tested and found to comply with the requirements listed in FCC Regulations, Part 15 for Class "B" digital devices. Compliance with these requirements provides a reasonable level of assurance that your use of this product in a residential environment will not result in harmful interference with other electronic devices. This equipment generates/uses radio frequencies and, if not installed and used according to the instructions found in the users manual, may cause interference harmful to the operation of other electronic devices. Compliance with FCC regulations does not guarantee that interference will not occur in all installations. If this

product is found to be the source of interference, which can be determined by turning the unit "OFF" and "ON", please try to eliminate the problem by using one of the following measures:

Relocate either this product or the device that is being affected by the interference.

Utilize power outlets that are on different branch (circuit breaker or fuse) circuits or install AC line filter/s.

In the case of radio or TV interference, relocate/reorient the antenna. If the antenna lead-in is 300 ohm ribbon lead, change the lead-in to co-axial type cable.

If these corrective measures do not produce satisfactory results, please contact the local retailer authorized to distribute this type of product. If you can not locate the appropriate retailer, please contact Yamaha Corporation of America, Electronic Service Division, 6600 Orangethorpe Ave, Buena Park, CA90620

The above statements apply ONLY to those products distributed by Yamaha Corporation of America or its subsidiaries.

\* This applies only to products distributed by YAMAHA CORPORATION OF AMERICA.

(class B)

### NEDERLAND / THE NETHERLANDS

- Dit apparaat bevat een lithium batterij voor geheugen back-up.
- This apparatus contains a lithium battery for memory back-up.
- Raadpleeg uw leverancier over de verwijdering van de batterij op het moment dat u het apparaat aan het einde van de levensduur afdankt of de volgende Yamaha Service Afdeling:  
Yamaha Music Nederland Service Afdeling  
Kanaalweg 18-G, 3526 KL UTRECHT  
Tel. 030-2828425
- For the removal of the battery at the moment of the disposal at the end of the service life please consult your retailer or Yamaha Service Center as follows:  
Yamaha Music Nederland Service Center  
Address : Kanaalweg 18-G, 3526 KL UTRECHT  
Tel : 030-2828425
- Gooi de batterij niet weg, maar lever hem in als KCA.
- Do not throw away the battery. Instead, hand it in as small chemical waste.

(lithium disposal)

### ADVARSEL!

Lithiumbatteri—Eksplodingsfare ved fejlagtig håndtering. Udskiftning må kun ske med batteri af samme fabrikat og type. Levér det brugte batteri tilbage til leverandoren.

### VARNING

Explosionsfara vid felaktigt batteribyte. Använd samma batterityp eller en ekvivalent typ som rekommenderas av apparattillverkaren. Kassera använt batteri enligt fabrikantens instruktion.

### VAROITUS

Paristo voi räjähtää, jos se on virheellisesti asennettu. Vaihda paristo ainoastaan laitevalmistajan suosittelemaan tyyppiin. Hävitä käytetty paristo valmistajan ohjeiden mukaisesti.

(lithium caution)

### Caution

Always use the supplied Yamaha AC Adaptor to power DTXTREME. The use of an incompatible adaptor may cause a serious shock hazard.

# PRECAUTIONS

## PLEASE READ CAREFULLY BEFORE PROCEEDING

\* Please keep this manual in a safe place for future reference.



### WARNING

Always follow the basic precautions listed below to avoid the possibility of serious injury or even death from electrical shock, short-circuiting, damages, fire or other hazards. These precautions include, but are not limited to, the following:

#### Power supply/AC power adaptor

- Only use the voltage specified as correct for the instrument. The required voltage is printed on the name plate of the instrument.
- Use the specified adaptor (PA-5C or PA-5D or an equivalent recommended by Yamaha) only. Using the wrong adaptor can result in damage to the instrument or overheating.
- Check the electric plug periodically and remove any dirt or dust which may have accumulated on it.
- Do not place the AC adaptor cord near heat sources such as heaters or radiators, and do not excessively bend or otherwise damage the cord, place heavy objects on it, or place it in a position where anyone could walk on, trip over, or roll anything over it.

#### Do not open

- Do not open the instrument or attempt to disassemble the internal parts or modify them in any way. The instrument contains no user-serviceable parts. If it should appear to be malfunctioning, discontinue use immediately and have it inspected by qualified Yamaha service personnel.

#### Water warning

- Do not expose the instrument to rain, use it near water or in damp or wet conditions, or place containers on it containing liquids which might spill into any openings.
- Never insert or remove an electric plug with wet hands.

#### Fire warning

- Do not put burning items, such as candles, on the unit. A burning item may fall over and cause a fire.

#### If you notice any abnormality

- If the AC adaptor cord or plug becomes frayed or damaged, or if there is a sudden loss of sound during use of the instrument, or if any unusual smells or smoke should appear to be caused by it, immediately turn off the power switch, disconnect the adaptor plug from the outlet, and have the instrument inspected by qualified Yamaha service personnel.



### CAUTION

Always follow the basic precautions listed below to avoid the possibility of physical injury to you or others, or damage to the instrument or other property. These precautions include, but are not limited to, the following:

#### Power supply/AC power adaptor

- When removing the electric plug from the instrument or an outlet, always hold the plug itself and not the cord.
- Unplug the AC power adaptor when not using the instrument, or during electrical storms.
- Do not connect the instrument to an electrical outlet using a multiple-connector. Doing so can result in lower sound quality, or possibly cause overheating in the outlet.

#### Location

- Do not expose the instrument to excessive dust or vibrations, or extreme cold or heat (such as in direct sunlight, near a heater, or in a car during the day) to prevent the possibility of panel disfiguration or damage to the internal components.
- Do not use the instrument in the vicinity of a TV, radio, stereo equipment, mobile phone, or other electric devices. Otherwise, the instrument, TV, or radio may generate noise.
- Do not place the instrument in an unstable position where it might accidentally fall over.
- Before moving the instrument, remove all connected adaptor and other cables.
- Use only the rack stand specified for the instrument. When attaching the stand or rack, use the provided screws only. Failure to do so could cause damage to the internal components or result in the instrument falling over.
- Do not place objects in front of the instrument's air vent, since this may prevent adequate ventilation of the internal components, and possibly result in the instrument overheating.

## Connections

- Before connecting the instrument to other electronic components, turn off the power for all components. Before turning the power on or off for all components, set all volume levels to minimum. Also, be sure to set the volumes of all components at their minimum levels and gradually raise the volume controls while playing the instrument to set the desired listening level.

## Maintenance

- When cleaning the instrument, use a soft, dry cloth. Do not use paint thinners, solvents, cleaning fluids, or chemical-impregnated wiping cloths.

## Handling caution

- Never insert or drop paper, metallic, or other objects into the gaps on the panel. If this happens, turn off the power immediately and unplug the power cord from the AC outlet. Then have the instrument inspected by qualified Yamaha service personnel.
- Do not place vinyl, plastic or rubber objects on the instrument, since this might discolor the panel.
- Do not rest your weight on, or place heavy objects on the instrument, and do not use excessive force on the buttons, switches or connectors.
- Do not operate the instrument for a long period of time at a high or uncomfortable volume level, since this can cause permanent hearing loss. If you experience any hearing loss or ringing in the ears, consult a physician.

## Backup battery

- This instrument has a built-in lithium backup battery. When you unplug the power cord from the AC outlet, the internal data is retained. However, if the backup battery fully discharges, this data will be lost. When the backup battery is running low, the LCD indicates "Battery voltage is low." In this case, immediately save the data to a Memory Card (SmartMedia)/external media such as the Yamaha MDF3 MIDI data filer, then have qualified Yamaha service personnel replace the backup battery.

## Saving data

### Saving and backing up your data

- DRAM data is lost when you turn off the power to the instrument. Save the data to a Memory Card (SmartMedia)/external media such as the Yamaha MDF3 MIDI data filer.

### Backing up the Memory Card (SmartMedia)/external media

- To protect against data loss through media damage, we recommend that you save your important data onto two Memory Cards (SmartMedia)/external media.

Yamaha cannot be held responsible for damage caused by improper use or modifications to the instrument, or data that is lost or destroyed.

Always turn the power off when the instrument is not in use.

Even when the power switch is in the "STANDBY" position, electricity is still flowing to the instrument at the minimum level. When you are not using the instrument for a long time, make sure you unplug the AC power adaptor from the wall AC outlet.

Make sure to discard used batteries according to local regulations.

# Introduction

Thank you for purchasing the Yamaha DTXTREME IIs Drum Trigger Module. The new DTXTREME IIs incorporates the highly acclaimed AWM2 tone generator and music sequencer. In addition to the functions of its predecessor, DTXTREME IIs provides full support of the current Yamaha trigger products and also sports a new USB port for MIDI connections (in addition to traditional MIDI ports) — and has a built-in sampling feature that allows you to create your own drum voices. With all these features, DTXTREME IIs makes an ideal trigger-based music system, offering the drummer one of the best solutions for practicing at home, rehearsing in the studio, and performing on stage. To fully enjoy your new instrument, please read this manual thoroughly. Also, keep this manual in a convenient location for future reference.



## How to Use This Manual

This manual describes all features and aspects of the DTXTREME IIs — for **Playing** (page 22), **Editing** (page 33), and global, or **Utility functions** (page 73). To familiarize yourself with the Instrument, refer to the following:

- **Table of Contents** (page 9) — for searching topics and features
- **Panel Map** (page 10) — for understanding each function on the panels at a glance
- **Index** (page 97) — for looking up a specific feature using keywords and parameter names
- **Cross-references** throughout the text — for related information on specific topics

In addition, the following Icons are used to indicate specific types of Important information:

 **NOTE** Describes additional detailed information on a topic.



Indicates special cautions and Information to avoid loss of data, damage to the instrument, etc.

## Contents of the Package

- DTXTREME IIs
- AC power adapter (PA-5C or PA-5D)
- Owner's Manual
- Data List
- DTXTREME IIs Installation Guide
- USB-MIDI driver (CD-ROM)

# Features

The DTXTREME II is designed for professional drummers and has a comprehensive variety of flexible drum-triggering features, a 64-note polyphonic tone generator compatible with the GM System Level 1 standard, as well as a built-in music sequencer that enables recording and playback of rhythm or accompaniment patterns, and even lets you create an entire song. The instrument is ideal for virtually any application — live performance, rhythm training, music creation and studio recording.

## Drum Triggering

---

- Flexible external controls via 16 trigger inputs (total of 12 jacks), hi-hat controller jack, and footswitch jack. These jacks can connect to any Yamaha triggering gear including traditional DTX/DTXPRESS drum pads, DT-series trigger pickups, and the latest drum pads.
- Combined with the latest drum pads, DTXTREME II enables manual control of the drum voice tone with a built-in knob.
- Freely adjustable trigger inputs. Each trigger input can be edited to suit the input device (type) connected to the jack, letting you determine the sensitivity and other settings.
- Freely assignable voices. Using MIDI note numbers, each trigger input can be assigned a specific voice from the internal tone generator. A set of trigger-to-voice configurations can be stored as a drum kit. DTXTREME II stores up to 40 drum kits internally and up to 99 externally on convenient memory cards. Also, DTXTREME II comes with 90 preset drum kits.
- Each trigger input can be set to play several MIDI note numbers simultaneously or sequentially, enabling the playing of chords or melodic phrases, or even entire drum patterns with a single pad.

## Tone Generator

---

- A variety of high-quality sounds (voices) in a 64-note polyphonic AWM2 (PCM) tone generator compatible with the GM System Level 1 standard.
- Preset voices include 2,174 drum or percussion sounds and 128 keyboard sounds. DTXTREME II offers dynamic drum voices, including high-quality Yamaha drum sounds, plus the latest samples and looped sounds — guaranteed to inspire you as you play and create.
- An all-new sampling feature that lets you easily add your own samples to the drum kit. DTXTREME II can also import samples (audio files) from the computer using memory cards.
- Each drum voice can be edited using various parameters for effects, volume, pan, pitch, and so on.

## Effects

---

- High-quality digital reverb and chorus are provided as System effects. A versatile pair of separate Insertion effects is also provided with 44 effect types.
- The Localizer provides a three-dimensional (3D) stereo effect that simulates natural sound when monitored with stereo headphones.

## Music Sequencer

---

- A wide variety of Preset songs. Also, the DTXTREME IIs has internal memory space for up to 32 User songs.
- Song playback. In addition to a main song that is controlled by the panel transport buttons or external MIDI events, DTXTREME IIs can play up to four pad-controlled songs assigned to a drum kit (pad songs). These songs can be freely selected from the Preset and User songs.
- Groove check feature that measures timing accuracy when hitting the pads. This is especially useful for practicing and learning purposes.
- Click feature for playing with the sequencer. You can choose a click sound separately from the drum kit settings.
- Simple and easy two-track sequencer that can be used for real-time recording of your performances or for recording external sequence data as User songs. Each track can contain several MIDI channels (1 to 16). Since the DTXTREME IIs can sync with an external sequencer, you can start recording by simply hitting a drum pad or Start button on the top panel or an external sequencer. The sequencer also offers step recording so that you can manually create or edit a song step-by-step, using the DTXTREME IIs LCD display.
- Selective playback feature. Since you can simply mute the drum or any other part in a song while controlling the volume of each part, this is ideal for “minus-one” practice and so on.

## Easy Operations and Useful Controls

---

- Backlit LCD display and LED display that provide clear visual information in any performing and editing situation.
- Data entry knobs. These five knobs on the top panel provide easy accessibility to parameters shown in the LCD display.
- Chain play feature that can play drum kits and songs in a specified order.
- Built-in mixing features. Top-panel volume slider controls let you easily adjust the volume balance between instruments or parts (drum kit, accompaniment, and click). These slider controls can even adjust the reverb return level for an entire drum kit, as well as the reverb send level for each instrument in the kit. This simplifies the process of adjusting the reverb settings to suit the acoustics of your surroundings. Two more dedicated slider controls are also provided for adjusting headphones and click (metronome) volumes.

## Interfaces and Expandability

---

- MIDI (IN, OUT, THRU) and USB ports offer connectivity between the DTXTREME IIs and external MIDI devices — such as a computer or sequencer — for advanced recording and data storage applications.
- Versatile sound outputs. In addition to the stereo outputs, there are six individual outputs for separately sending specific sounds (snare drum, bass drum, tom, etc.) to an external mixer for further processing. Also, the new digital output (S/PDIF) is useful to transfer the DTXTREME IIs stereo sounds with digital quality.
- External sound input. Use the AUX IN stereo jack to connect an audio player (CD, MD, tape, etc.) — and play the drum kit along with playback of your favorite songs. This jack can also be used for sampling from the connected audio source.
- External storage using the memory card (SmartMedia). You can use the memory card to store and read data including drum kits, songs, and chains. The memory card can also be used to supply a waveform sample (audio file) for sound expansion.



# Table of Contents

<b>Introduction</b> .....	<b>6</b>	<b>Edit Section</b> .....	<b>33</b>
<b>How to Use This Manual</b> .....	<b>6</b>	<b>DTXTREME IIs as Drum System</b> .....	<b>33</b>
<b>Contents of the Package</b> .....	<b>6</b>	From Trigger Input to Sound Output . . .	33
<b>Features</b> .....	<b>7</b>	<b>Memory, Buffer, and Store Operation</b> .	<b>35</b>
<b>Panel Map</b> .....	<b>10</b>	<b>Trigger Settings</b> .....	<b>36</b>
Top Panel .....	10	Edit Pages and Basic Operations .....	36
Rear Panel .....	12	<b>Voice Settings</b> .....	<b>48</b>
<b>Setup</b> .....	<b>14</b>	Edit Pages and Basic Operations .....	48
<b>Pads and Triggers</b> .....	<b>14</b>	<b>Effect Settings</b> .....	<b>55</b>
Compatible Products .....	14	Reverb .....	55
Peripherals .....	17	Chorus .....	55
MIDI Connections .....	18	Insertion Effects 1 and 2 .....	55
<b>Power</b> .....	<b>19</b>	Localizer .....	55
Connecting to a Power Source .....	19	<b>Song Recording and Editing</b> .....	<b>60</b>
Power-On Sequence .....	19	<b>Features of the Two-track Sequencer</b> .	<b>60</b>
<b>Basic Operations</b> .....	<b>20</b>	<b>Preparation for Recording</b> .....	<b>60</b>
Matching Trigger Inputs		<b>Recording Operations</b> .....	<b>62</b>
with Connected Pads .....	21	<b>Song Job Features</b> .....	<b>65</b>
<b>Play Section</b> .....	<b>22</b>	Edit Pages and Basic Operations .....	65
<b>Basic Items</b> .....	<b>23</b>	<b>Utility Features</b> .....	<b>73</b>
<b>Playback Controls</b> .....	<b>24</b>	Edit Pages and Basic Operations .....	73
Click Playback .....	24	Sampling Feature .....	82
Song Playback .....	24	Memory Card Feature .....	85
Slider Controls .....	26	<b>Appendix</b> .....	<b>90</b>
<b>Tap Tempo Feature</b> .....	<b>28</b>	<b>Handling the Memory Card</b>	
<b>Groove Check Feature</b> .....	<b>29</b>	<b>(SmartMedia™*)</b> .....	<b>90</b>
<b>Chain Feature</b> .....	<b>30</b>	<b>Troubleshooting</b> .....	<b>91</b>
Switching the Chain Display .....	30	<b>Error Messages</b> .....	<b>94</b>
Creating or Editing a Chain .....	30	<b>Specifications</b> .....	<b>96</b>
Playing a Chain .....	32	<b>Index</b> .....	<b>97</b>

Panel Map

Setup

Basic Operations

Play Section

Edit Section

Song Recording and Editing

Utility Features

Appendix

The illustrations and LCD screens as shown in this Owner's Manual are for instructional purposes only, and may appear somewhat different from those on your instrument.

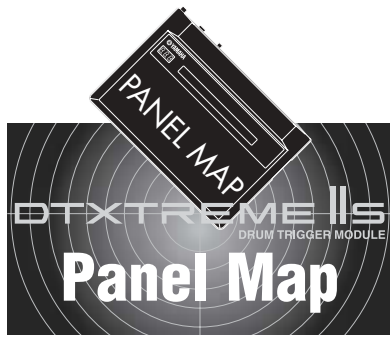

## Top Panel

## Basic Operations

### 1 SHIFT button

Use this button to modify the original function of specific panel controls (button, knob, and slider).

### 2 Page buttons (▲/▼)

While editing each function, use these buttons to go to the next page (▼) or the previous page (▲). Hold down either button to scroll forward or backward between pages. By simultaneously holding down the SHIFT button and pressing each button, you can move to the first (▲) or last (▼) page very quickly.

### 3 Displays

The LCD shows information and data for various DTXTREME II's operations, and the LED display indicates the current drum kit or tempo value.

## Selecting Playback Parts

### 6 RHYTHM/INS button

During song playback, pressing this button activates or cancels playback of the rhythm part. During step recording, it is used to insert data at the cursor point.

### 7 BASS/DEL button

During song playback, pressing this button activates or cancels playback of the bass part. During step recording, it is used to delete data at the cursor point.

### 8 OTHERS button

During song playback, pressing this button activates or cancels playback of parts other than the rhythm and bass parts.

### 9 CLICK button

Pressing this button activates or cancels playback of the click (metronome) sound. By simultaneously holding down the SHIFT button and pressing this button, you can use the Tap Tempo feature (page 28).

## Transport Controls

### 10 Reset button (⏮)

Pressing this button while the song is stopped moves the playback point to the beginning of a song (unavailable during song playback). By simultaneously holding down the SHIFT button and pressing this button, you can use the Groove Check feature (page 29).

### 11 Rewind button (⏪)

Pressing this button moves the playback point to the previous measure (unavailable during song playback).

### 12 Start/Stop button (▶/■)

Pressing this button starts or stops playback or recording of a song. Pressing this button during song playback pauses playback. Pressing the button a second time resumes song playback from the stopped point.

### 13 Forward button (▶▶)

Pressing this button moves the playback point to the next measure (unavailable during song playback).

### 14 Record button (●)

Pressing this button enables recording standby.

## Front Panel

### 35 PHONES jack

Connect headphones here to monitor the stereo mix of the DTXTREME II's sounds.

### 36 AUX IN jack

Connect the line output from an external audio device here. You can play along with an external audio source (page 17), as well as record external audio as a waveform sample (page 83).

### 37 AUX IN VOL control

Adjusts the input level of an audio source connected to the AUX IN jack.

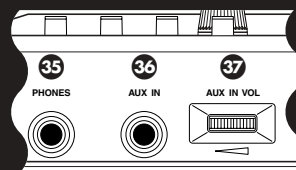

## Master Volume Controls

### 15 MAIN OUT slider

Adjusts the output volume of the stereo mix from the OUTPUT L/MONO and R jacks.

### 16 PHONES slider

Adjusts the output volume of the stereo mix from the PHONES jack. This is independent from the MAIN OUT slider setting.

### 17 CLICK slider

Adjusts the output volume of the click sound from the specified output jack (page 81).

### 18 ACCOMP/REVERB slider

Adjusts the output volume except for rhythm sounds (MIDI channel 10). Moving this slider while holding down the SHIFT button lets you control the entire return level of the reverb effect.

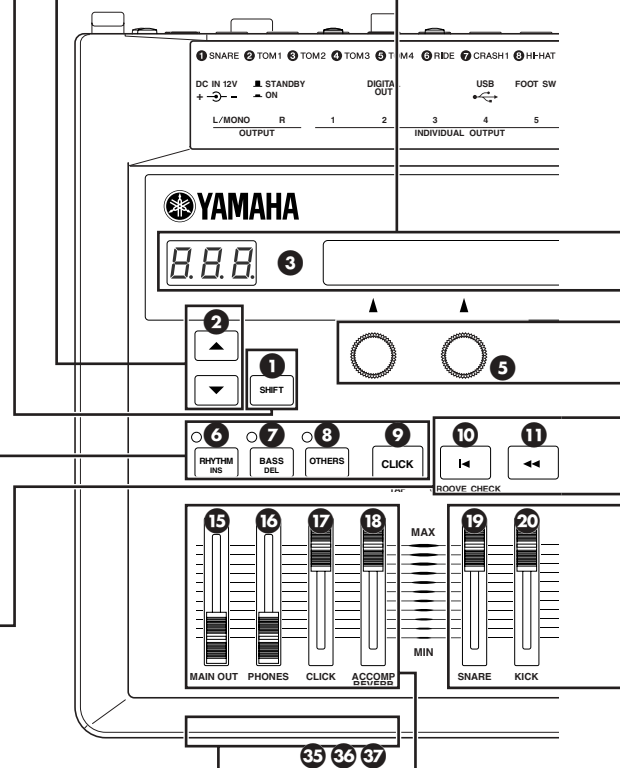

#### 4 Audition button

Press this button to audition a target voice while editing a drum kit, just like hitting a pad for that voice. Pressing this button while holding down the SHIFT button can stop playback of a looped voice or a pad song.

#### 5 Data entry knob

Use each knob to set the corresponding parameter value shown above it in the LCD. By simultaneously holding down the SHIFT button and turning the knob, you can increase or decrease the value in large jumps.

## Side Panel

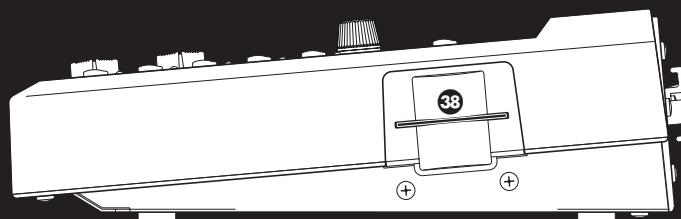

#### CARD slot

Insert an optional SmartMedia (3.3V) here for use as a memory card (page 90).

## Function Modes

#### 25 PLAY button

Press this button to select and play a drum kit or song (basic operation mode).

#### 26 CHAIN button

Press this button to play different drum kits and songs sequentially in a chain.

#### 27 UTILITY button

Press this button for system settings, sampling feature, and memory card functions.

#### 28 SONG JOB button

Press this button to edit a User song.

#### 29 TRIGGER button

Press this button to edit trigger parameters for a drum kit.

#### 30 VOICE button

Press this button to edit voice parameters for a drum kit.

#### 31 EFFECT button

Press this button to edit effect parameters for a drum kit.

## Other Operations

#### 32 STORE button

Press this button to store a drum kit or a chain.

#### 33 EXIT/NO button

Press this button to exit from each function mode, or to cancel an operation when a confirmation message is shown in the LCD.

#### 34 ENTER/YES button

Press this button to determine a parameter value, or execute an operation when a confirmation message is shown in the LCD.

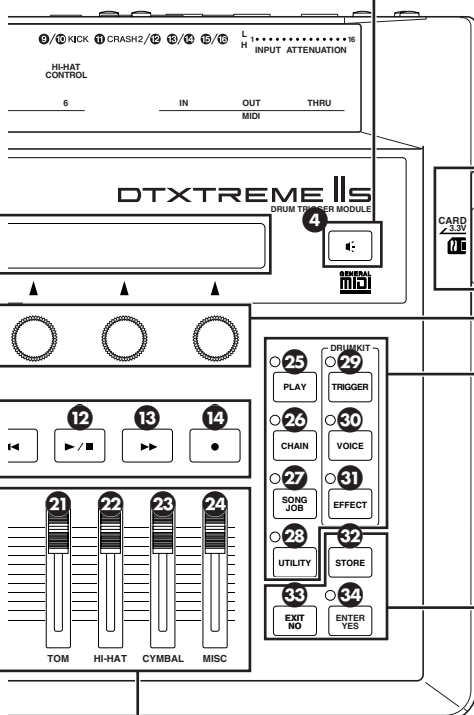

## Volume Controls of Rhythm & Drum Instruments

#### 19 SNARE slider

Adjusts the snare drum volume.

#### 20 KICK slider

Adjusts the bass drum volume.

#### 21 TOM slider

Adjusts the volume of the toms.

#### 22 HI-HAT slider

Adjusts the hi-hat volume.

#### 23 CYMBAL slider

Adjusts the cymbal volume.

#### 24 MISC slider

Adjusts the volume of miscellaneous rhythm or percussion sounds — other than snare and bass drums, toms, hi-hats, and ride and crash cymbals.

**NOTE** By simultaneously holding down the SHIFT button and moving the slider controls 19 to 24, you can adjust the reverb send level or the output level from the INDIVIDUAL OUTPUT jack for the corresponding instrument (page 27).

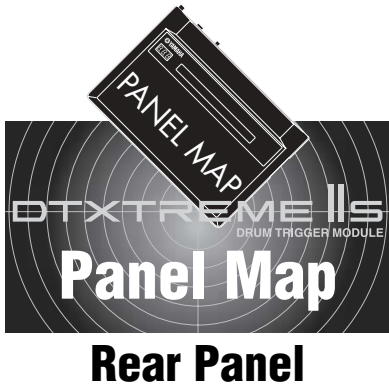

## MIDI I/O

### MIDI IN, OUT, and THRU terminals

Use the MIDI terminals to transfer MIDI events between the DTXTREME IIs and an external device such as sequencer or tone generator, for an extended MIDI system (page 18).

### USB port

By simply connecting the DTXTREME IIs to a computer with a single USB cable, you can transfer MIDI events between these two devices. You do not need additional MIDI cables, MIDI interface, or a serial port on the computer (page 18).

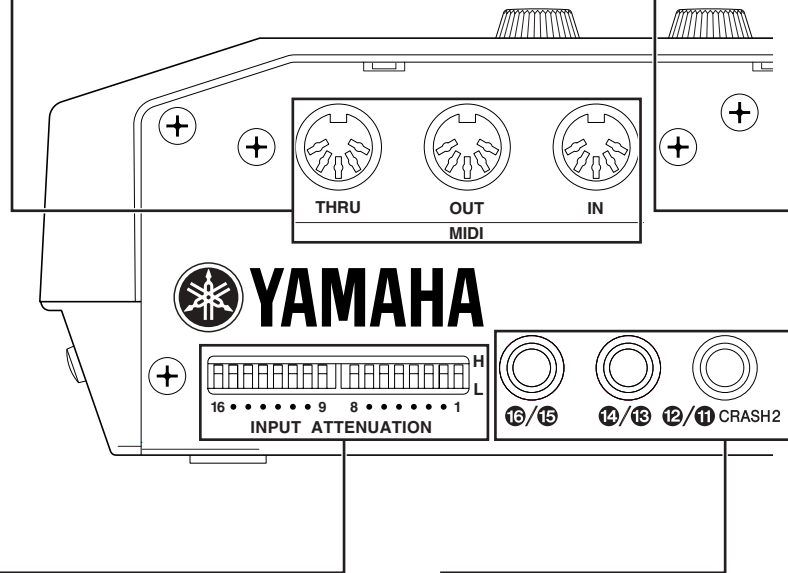

### INPUT ATTENUATION switches

Each DIP switch corresponds to a trigger input jack and adjusts its sensitivity. This is useful when connecting pads and trigger sensors with a lower trigger signal. Set the DIP switch to the **H** position to boost (increase) the trigger signal level.

### 9/10 KICK to 15/16

Each of these trigger input jacks is designed to accept two separate trigger signals from two mono (single) pad connected using a Y-shaped cable with a stereo phone plug at the trigger input end and two mono plugs at the pads' ends. If connected using a mono cable (a shielded cable with a mono phone plug at each end), the trigger signal will be routed only to odd-numbered trigger inputs (**9**, **11**, **13**, or **15**). See "Compatible Products" (page 14) for a recommended pad product for each trigger input.

## Trigger Inputs

## Audio Outputs

### INDIVIDUAL OUTPUT 1 to 6 jacks

Each of these jacks can separately output any specified drum voice (page 53) or click sound (page 81)—useful for sending each instrument signal to an external mixer for live performance or recording session.

### DIGITAL OUTPUT jack

Connect to a coaxial digital input (S/P DIF) on an external audio device. This jack digitally outputs stereo audio signals identical to those from the OUTPUT L/MONO and R jacks, but not affected with the MAIN OUT **15** volume slider setting (the digital jack always outputs audio signals at a maximum volume level).

### OUTPUT L/MONO and R jacks

Outputs line level stereo-mixed audio signals from the DTXTREME IIs to other audio equipment (amp, mixer, etc.). Use a pair of shielded cables with a 1/4-inch phone plug on one or both ends. Connect those cables to both L/MONO and R jacks if you want to output in stereo. Connect only to the L/MONO jack if you want to output in mono.

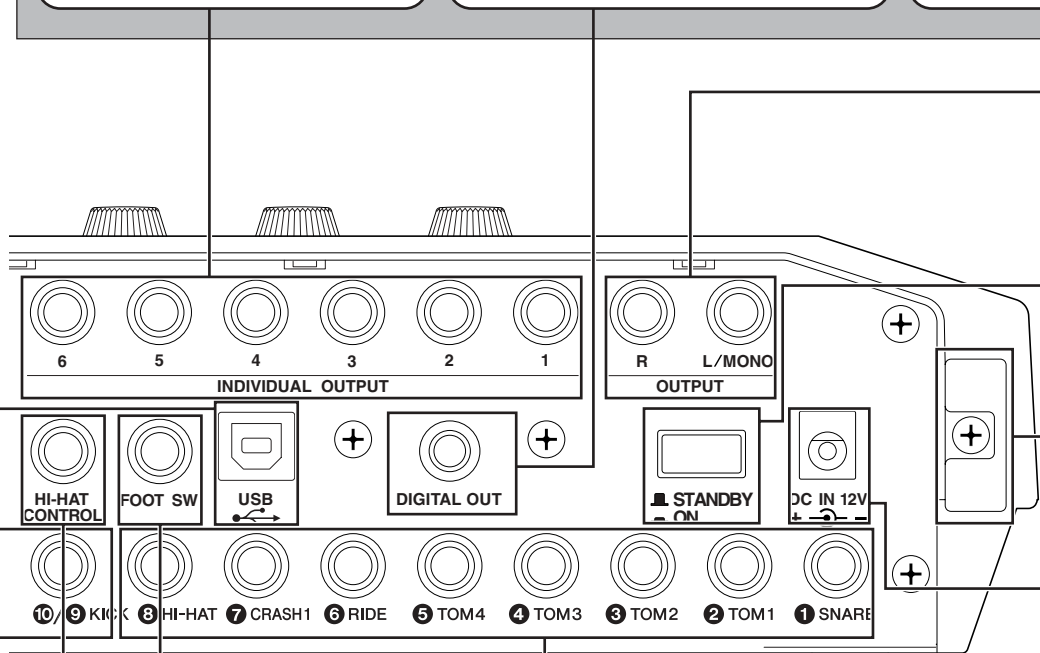

## Power

### STANDBY/ON switch

Turns the DTXTREME IIs on or off.

### Cable hook

Fix the DC power cord of the supplied AC power adapter here to ensure the plug will not come loose.

### DC IN jack

Connect the supplied AC power adapter (PA-5C or PA-5D) here.

### HI-HAT CONTROL jack

Connect a foot controller for hi-hats (Yamaha HH series) here. You can also use this controller as a MIDI controller (page 45).

### FOOT SW jack

Connect a foot switch (Yamaha FC4 or FC5) here. You can assign various functions to the foot switch (page 46).

### 1 SNARE to 8 HI-HAT

Each of these trigger input jacks is designed to accept two separate trigger signals from a stereo (dual) pad connected using a stereo cable (a shielded cable with a stereo phone plug at each end). If you connect a mono pad, only the head-generated trigger signal can be used.

# Setup

## Pads and Triggers

### Compatible Products

You can use the DTXTREME IIs with any currently available Yamaha pad products. Since each pad is designed for a specific purpose and has its own specifications, you'll need to check which product is most suitable for connecting to a specific DTXTREME IIs trigger input. When you purchase additional pads for your kit, refer to the following table for optimum compatibility.

**NOTE** For detailed information on Yamaha pad products, refer to the DTXTREME IIs product brochure or your local Yamaha website.

#### Drum Pad (TP100/TP120SD)

A new series of drum pads that adopt a newly developed rubber head. When used for the snare drum and toms, these pads can produce real continuous tone change by three-zone position sensing. These pads also employ a new pad controller for adjusting the snare or tom tone (such as tuning) while playing the kit.

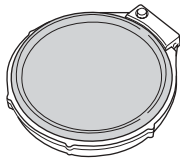

#### Real Head Pad (RHP/KP series)

These pads feature a wooden drum shell made of plied birch and mahogany, and a real drum head — just as on acoustic drums. This series include three different pads for bass drum, snare drum, and toms and designed especially for use with Yamaha System Drums.

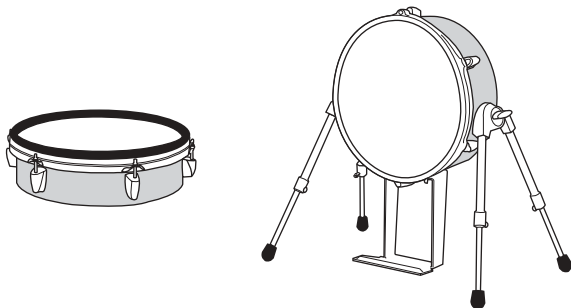

#### Rubber Pad (TP/PCY/KP/BP series)

Standard lineup of drum and trigger pads made of rubber material. In addition to traditional dual and single trigger pads (dual pads have a rim switch), several new pads with three-zone position sensing feature are also available. These pads are convenient for triggering pad songs or switching a drum kit or song in chain play.

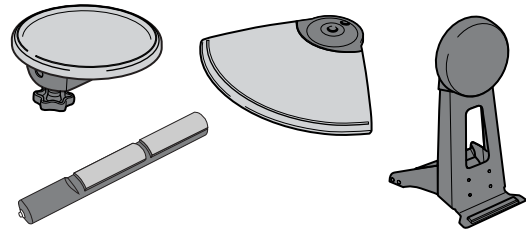

#### Hi-hat Controller (HH/RHH series)

Indispensable for subtle hi-hat work with a DTXTREME IIs drum kit. Choose your favorite combination of the hi-hat "pedal and cymbals," such as HH-series controller and TP-series pad. You can even choose a real hi-hat stand (such as Yamaha HS series) and an RHH130 pad with two zone position sensing.

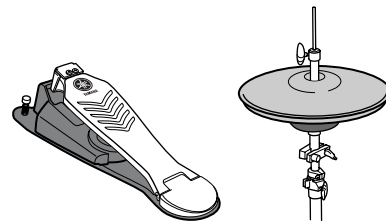

#### Drum Trigger (DT series)

These trigger pickups are designed for attaching to acoustic drums, making them ideal for expanding the capabilities of your acoustic drum kit with the DTXTREME IIs electronic sounds. Each pickup can produce a single trigger. Keep in mind that attaching two drum triggers to a single snare drum will not produce the same effect as using a dual trigger pad.

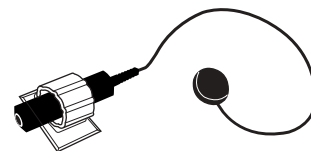

## Attaching a Drum Trigger

To use an acoustic drum as a triggering device, you will need to attach a Yamaha DT-series drum trigger. Observe the following precautions and attach the trigger properly as described in the diagrams below.

- First remove dust or oily dirt from the batter head or drum shell to which you will apply the sensor using a cloth dampened with water or an alcohol (use no chemical solvents), then apply the sensor.
- Cover the sensor and cord with tape to avoid accidental disconnection that may be caused by drum vibrations.
- Double triggering may occur if the drum head produces a sustained sound or irregular vibrations. If this is the case, change the tuning or mute the head to avoid unnecessary vibrations. It is recommended to use the ring mute.

### Attaching to a Bass Drum

Attach the sensor portion of the trigger near the rim on the batter head. Ensure that the sensor does not touch the rim.

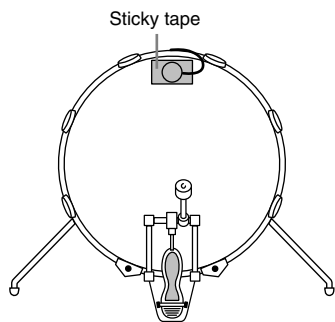

### Attaching to a Snare Drum

Attach the sensor portion of the trigger near the rim at the opposite end to the player, on the batter head. Ensure that the sensor does not touch the rim.

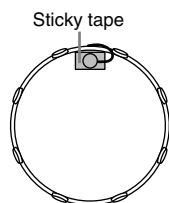

### Attaching to a Tom

Attach the sensor portion of the trigger near the rim on the shell. Ensure that the sensor does not touch the rim or other parts in the drum kit (snare drum, other toms, percussion instruments, etc.).

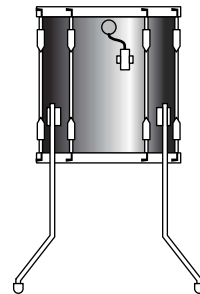

### Detaching a Drum Trigger

You'll need to detach the trigger when replacing the drum head. Before removing the head, remove the sensor portion of the trigger carefully using a knife or similar object. Be careful not to pull the cord.

**NOTE** When replacing the sensor, remove any remnants of the old tape completely and then re-attach it using new tape. Such remnants may cause problems regarding trigger sensitivity (poor or no triggering, double triggering, etc.).

# Trigger Connections

Referring to the following table, connect each pad to the appropriate trigger input jack on the DTXTREME IIs rear panel. Appropriate names are printed beside each jack, making it easy to make the relevant pad connections.

## Pad-to-Input Matching Chart

Y=Yes, N=No

Trigger input	1 Snare	2, 3, 4, 5 Tom	6, 7 Cymbal	8 Hi-Hat	9/10 Kick	11/12 to 15/16 Cymbal & others
Rim configurations	switch & piezo	switch & simple piezo	switch only	switch only	piezo only	piezo only
3-zone detection	Y	Y	Y	Y	N	N
Pad controller compatibility	Y	Y	N	N	N	N

New	Model No.	Model Name	1	2, 3, 4, 5	6, 7	8	9/10	11/12 to 15/16
	TP60	Tom Pad	▲	▲	(▲)	▲	(▲)	▲
	TP65	Tom Pad	●	●	(●)	●	(▲)	▲
	TP65S	Tom Pad	●	●	(●)	●	(▲)	▲
	TP80	Tom Pad	▲	▲	(▲)	▲	(▲)	▲
	TP80S	Tom Pad	■	■	(■)	■	(▲)	▲
✓	TP100	Tom Pad	●	●	(●)	(●)	(▲)	▲
✓	TP120SD	Snare Pad	●	●	(●)	(●)	(▲)	▲
	RHP80	Real Head Pad	■	■	(▲)	▲	(■)	■
	RHP100	Real Head Pad	■	■	(▲)	▲	(■)	■
	RHP120	Real Head Pad	■	■	(▲)	▲	(■)	■
	RHP120SD	Real Head Pad	■	■	(▲)	▲	(■)	■
✓	RHH130	Hi-hat Pad	(■)	(■)	(■)	●	(▲)	(▲)
	PCY10	Cymbal Cap Pad	(▲)	(▲)	▲	(▲)	(▲)	▲
	PCY60	Cymbal Pad	(▲)	(▲)	▲	(▲)	(▲)	▲
	PCY65	Cymbal Pad	(▲)	(▲)	▲	(▲)	(▲)	▲
	PCY65S	Cymbal Pad	(■)	(■)	■	(■)	(▲)	▲
	PCY80	Cymbal Pad	(▲)	(▲)	▲	(▲)	(▲)	▲
	PCY80S	Cymbal Pad	(■)	(■)	■	(■)	(▲)	▲
✓	PCY130	Cymbal Pad	(▲)	(▲)	▲	(▲)	(▲)	▲
✓	PCY130S	Cymbal Pad	(■)	(■)	■	(■)	(▲)	▲
✓	PCY150S	Cymbal Pad	(●)	(●)	●	(●)	(▲)	▲
	KP60	Kick Pad	(▲)	(▲)	(▲)	(▲)	(▲)	▲
	KP65	Kick Pad	(▲)	(▲)	(▲)	(▲)	▲	▲
	KP80	Kick Pad	(▲)	(▲)	(▲)	(▲)	▲	▲
	KP80S	Kick Pad	(▲)	(▲)	(▲)	(▲)	▲	▲
	KP120	Real Kick Head Pad	(▲)	(▲)	(▲)	(▲)	▲	▲
	BP80	Bar Pad	(▲)	(▲)	(▲)	(▲)	(■)	■
	DT10	Drum Trigger	▲	▲	▲	▲	▲	▲
	DT20	Drum Trigger	▲	▲	▲	▲	▲	▲
	DT30	Drum Trigger	▲	▲	▲	▲	▲	▲
	HH80A	Hi-hat Controller						
	HH60	Hi-hat Controller						
	HH65	Hi-hat Controller						

●..... Three voices available from pad, rim 1 and rim 2.

■..... Two voices available from pad and rim.

▲..... One voice available from pad.

\* Bracketed combinations indicate that they do not match the preset voice.

**NOTE** An HH-series hi-hat controller connected to the FOOT SW jack can be used as a second kick pedal (page 46).

**NOTE** For trigger input jacks connected with drum triggers, set their INPUT ATTENUATION switches to the **H** position (otherwise, set to the **L** position) and set their trigger sensitivity for the drum trigger (page 36).



# Peripherals

In addition to the built-in triggering system, DTXTREME IIs also features a built-in MIDI tone generator, built-in music sequencer, and mixing functions with various effects. This all-in-one self-contained system makes it possible to play the DTXTREME IIs system right out of the box — once you finish pad connections and turn the system on. What's more, the system can easily be expanded with other peripheral devices since the instrument supports various types of connections. Here we'll show you some typical audio and MIDI connections so that you can learn how to fit the DTXTREME IIs system into your own working environment.

## Audio Connections

When recording your performance on a DTXTREME IIs drum kit or sending its sounds to a mixer, connect your equipment as follows (Yamaha AW4416 works in both situations as mixer and recorder):

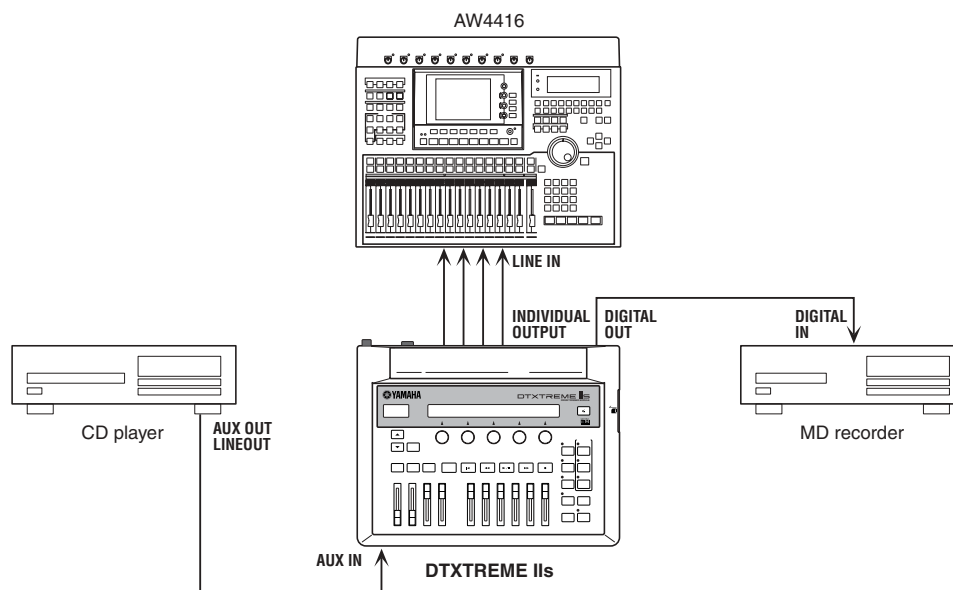

The OUTPUT (L/MONO and R) and INDIVIDUAL OUTPUT (1 to 6) jacks produce line level audio signals regardless of whether headphones are connected or not. These jacks are mono phone type. To make audio connections via these jacks, use cables with a mono phone plug for the DTXTREME IIs and an appropriate plug for the other device.

Use both of OUTPUT jacks (L/MONO and R) for stereo output. If the other device has a mono input, use the L/MONO jack only.

Connect a set of headphones to the PHONES jack for monitoring the stereo output (identical to that of the OUTPUT jacks). The sounds output from the INDIVIDUAL OUTPUT jacks cannot be heard from the headphones connected to the PHONES jack.

The DIGITAL OUTPUT terminal allows you to output the stereo signal as digital audio to an audio device that has a coaxial-type digital input (S/PDIF). The stereo output from the DIGITAL OUTPUT jack is identical to that output from the OUTPUT jacks.

External audio signals input to AUX IN can be monitored together with the DTXTREME IIs sounds via headphones connected to the PHONES jack (page 75), and can be recorded as a waveform sample for an additional drum voice (page 83). In either case, you can adjust the AUX IN input level using the AUX IN VOL control.

# MIDI Connections

DTXTREME IIs has USB and MIDI (IN/OUT/THRU) ports, and you can use these to transfer MIDI events to/from external MIDI-equipped devices.

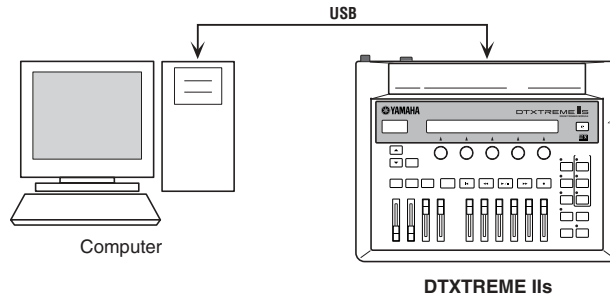

The USB port allows bi-directional transfer of MIDI events between the DTXTREME IIs and a personal computer with a single USB cable. With a USB connection, you can record your performance on the drum kit — and even the song playback of the Instrument — with MIDI sequencer software on your computer. You can also play the internal tone generator of the DTXTREME IIs with a MIDI sequence from the computer or capture it to the Instrument as a DTXTREME IIs song.

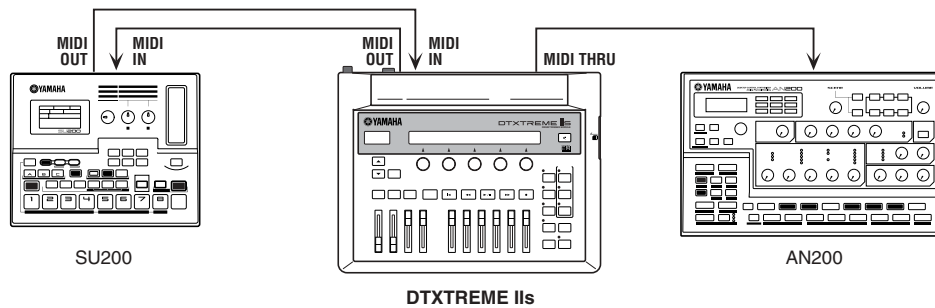

The MIDI ports offer one-way transfer of MIDI events. Use MIDI OUT to play an external sound module with a DTXTREME IIs drum kit or song. Use MIDI IN to control the internal tone generator from an external device. You can use MIDI THRU to connect an additional external sound module, controlling it from a MIDI controller connected to MIDI IN. If you want to share an external sound module with DTXTREME IIs and an external controller, connect the controller to MIDI IN, connect the module to MIDI OUT, and use the MIDI merge function (page 79).

**NOTE** You cannot use USB and MIDI ports simultaneously. When you connect a USB cable to the DTXTREME IIs, the MIDI ports are automatically disabled. If you make MIDI and USB connections at the same time, external devices connected to any MIDI port will not function. However, if you want to make a temporary USB connection to a computer for some reason, you can keep the MIDI devices connected to the DTXTREME IIs, since the USB connection does not affect or harm the MIDI devices at all.

# Power

## Connecting to a Power Source

Make sure that the STANDBY/ON switch is in the STANDBY position. Plug the supplied AC power adapter to the DC IN jack on the DTXTREME IIs rear panel. Fix the power cord to the cable hook, ensuring that the adapter plug does not come loose. Connect the adapter to an AC outlet.

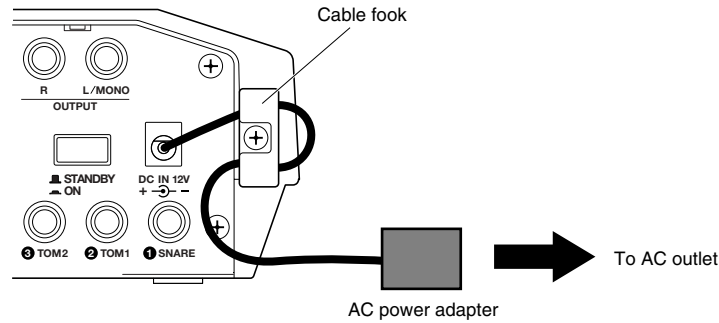

Always use the supplied AC power adapter (PA-5C or PA-5D). Use of a power adapter other than the type specified may cause a malfunction or result in damage to the DTXTREME IIs. Also, unplug the power adapter from the AC outlet if the DTXTREME IIs is not used for an extended period of time.

## Power-On Sequence

After you've made all necessary connections (trigger, audio, MIDI), turn down all volume controls of the DTXTREME IIs and other audio equipment. Turn on your system in the order of the audio signal flow (first the mixer, then the amplifier or powered speakers).

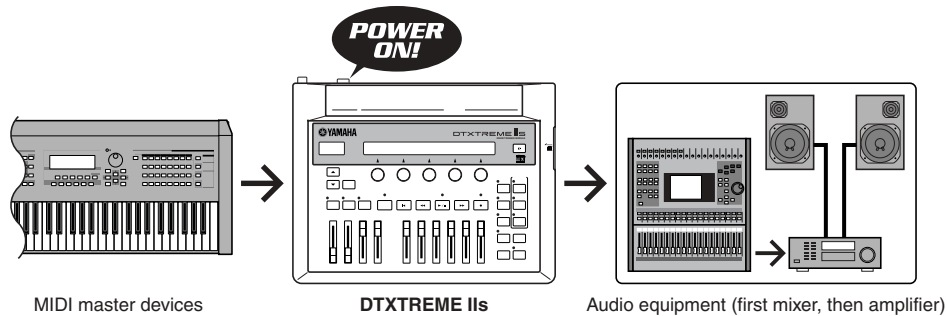

The DTXTREME IIs displays a splash screen, and then shows PLAY mode screen. Now you can start playing.

```
KIT=P1  SONG=P1  TEMPO  BEAT  CLICK  
Kit name Songname  ↓=107  4/4  ↓
```

If you are ready, see the next page for detailed explanations on how to use the DTXTREME IIs system.

**NOTE** When turning off your system, first turn down all volume controls for the audio equipment, then turn off devices in the reverse order of the audio signal flow.

# Basic Operations

All of the DTXTREME IIs operations are done using the various panel controls and the two displays. In this section, we'll explain how to use these controls.

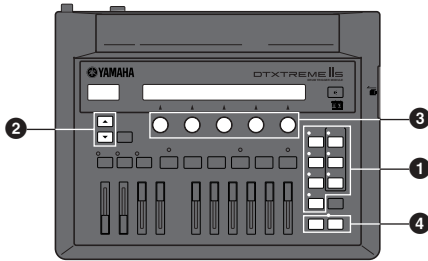

**1** The DTXTREME IIs has seven function modes. You can select each mode by simply pressing the corresponding mode button. An indicator light shows which mode you are currently working in. When you turn the unit on or exit from the other six modes, the DTXTREME IIs will go into PLAY mode and the PLAY indicator will light (you cannot exit from this basic mode).

**2** Use the Page buttons (▲/▼) to switch among the available setting pages (LCD screens).

**3** There are five knobs beneath the LCD display. Each knob corresponds to a parameter shown above in the LCD screen and can be used to set the value. To advance rapidly or jump through the available values, simultaneously hold down the SHIFT button and turn the appropriate knob.

When you are editing a drum kit and want to set the same parameters for different targets (trigger inputs 1 to 16, etc.), you can use the leftmost knob to conveniently switch the target without changing the screen you are working in.

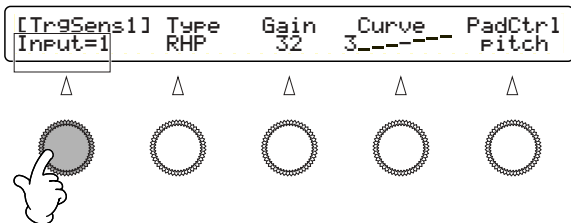

**4** If you are working in a specific page or performing a specific operation, and the ENTER/YES indicator flashes, this is a prompt indicating you should answer YES or NO. Simply press the ENTER/YES button to execute the operation, or press the EXIT/NO button to cancel it. Pressing the STORE button to save edited data also causes the ENTER/YES indicator to flash. In this case, press the ENTER/YES button to save the data, or press the EXIT/NO button to cancel the store operation.

**NOTE** Since most settings are automatically stored into the memory of the DTXTREME IIs, you do not need to execute the store operation unless prompted.

Basically, this is all you need to know to start working with and playing your DTXTREME IIs. Any crucial operations are preceded by a confirmation display that allows you to cancel the operation as needed. However, you must first complete one very important setting before actually playing with the DTXTREME IIs. Here is a chance to put into practice some of the things you've just learned...

# Matching Trigger Inputs with Connected Pads

Since each drum pad has its own characteristics, you need to appropriately set the trigger inputs to make most of the connected pads. The DTXTREME IIs features six different trigger sets for typical combinations of pads. Select the set that best matches your drum kit.

1. Press the UTILITY button. Then press the Page button (▼) several times until the [UT 6] SYSTEM TRIGGER page appears.
2. Select a trigger set (TrgSet) from the six presets. If you purchased DTXTREME IIs with a recommended pad set, one of the six presets (type1 to type6) will perfectly match your setup.

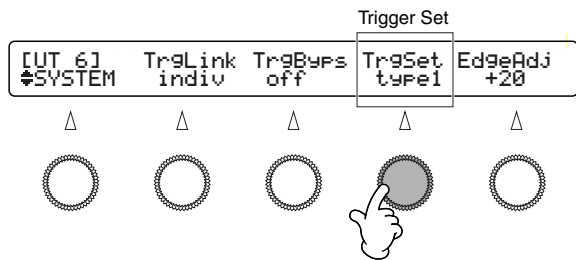

Trigger Input Jack	Trigger Set						
	Type1	Type2	Type3	Type4	Type5	Type6	
SNARE	1	TP 120SD	TP 120SD	any RHP	any RHP	TP 65S	any TP
TOM1	2	TP 100	TP 65S	any RHP	any TP	any TP	any TP
TOM2	3	TP 100	TP 65S	any RHP	any TP	any TP	any TP
TOM3	4	TP 100	TP 65S	any RHP	any TP	any TP	any TP
TOM4	5	TP 100	TP 65S	any RHP	any TP	any TP	any TP
RIDE	6	PCY 150S	PCY 150S	PCY 150S	any PCY	any PCY	any PCY
CRASH1	7	any PCY	any PCY	any PCY	any PCY	any PCY	any PCY
HI-HAT	8	RHH 130	RHH 130	RHH 130	any TP	any TP	any TP
KICK	9	any KP	any KP	KP 120	KP 120	any KP	any KP
(reserved)	10	any KP	any KP	KP 120	KP 120	any KP	any KP
CRASH2	11	any PCY	any PCY	any PCY	any PCY	any PCY	any PCY
(reserved)	12	any TP					
(reserved)	13	any PCY					
(reserved)	14	any TP					
(reserved)	15	any TP					
(reserved)	16	any TP					

**NOTE** “Any” specified pad will not always produce all sounds available. For more information, refer to “Trigger Connections” (page 16).

3. When you complete the setting, press the EXIT/NO button and return to PLAY mode.

Now you are ready to start playing with the DTXTREME IIs drum kit. Go to the Play Section to learn some of the performance functions of the DTXTREME IIs.

**NOTE** Preset trigger sets (type1 to type6) are used for the Preset kits (P1 to P90). When you play one of the User kits (U1 to U40 or C1 to C99), use your own trigger set copied from a preset or created from scratch. For details, refer to Trigger Settings (page 36).

# Play Section

---

The DTXTREME II conveniently always enters the Play mode when it is turned on. The Play mode is where you can start working and playing with the DTXTREME II — simply select a drum kit and song to play (or edit in other modes). Other features related to performance are also accessible in Play mode.

You can play any drum kit chosen from 90 Preset kits (P1 to P90) and 40 User kits (U1 to U40) that you can create and store in the DTXTREME II's memory. You can also select a main song from a variety of Preset songs (song numbers starting with P, Q and R) and 32 User songs that can be recorded into the DTXTREME II's memory (page 60). By using an optional memory card to store your User kits (C1 to C99), you can have a virtually unlimited number of drum kits at your disposal.

Use any combination of a drum kit and a song for rehearsals, jam sessions, etc. You can even create a complex drum solo by controlling playback of up to four songs using the pads (see Pad song, page 25).

In this section, we'll introduce you to some of the Play mode features, such as:

- Basic items
- Playback controls
  - Click playback
  - Song playback
  - Slider control
- Tap tempo
- Groove check
- Chain

# Basic Items

From this default screen, you can select and set basic parameters such as drum kit, song, tempo, beat, and click count. These parameters can be freely changed while you are playing the drum kit, click, or song.

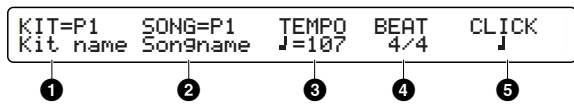

## 1 KIT

Selects a drum kit. The name and number of the drum kit is displayed. P1 to P90 are Preset kits, and U1 to U40 are User kits. C1 to C99 are User kits stored to memory card. (These are available only when an appropriate card is inserted in the CARD slot; otherwise “No Card” will be shown for these numbers.)

□ **Settings:** P1-P90, U1-U40, C1-C99

## 2 SONG

Selects the desired main song for playing with the current drum kit. The name and number of the song is displayed. Song numbers starting with the letter, P, Q, and R are Preset songs. P songs are demo, Q songs are suitable for practice, R songs are suitable for pad songs, and U1 to U32 are User songs. C1 to C99 are User songs stored to memory card. (These are available only when an appropriate card is inserted in the CARD slot; otherwise “No Card” will be shown for these numbers.)

□ **Settings:** Preset or User song

## 3 TEMPO

Sets the playback tempo of the song or click.

□ **Settings:** 30-300

**NOTE** TEMPO is not adjustable when “J=ext” is displayed, or in other words, when DTXEXTREME IIs is synchronized to an external clock (page 82).

**NOTE** Since every song contains information about the playback tempo, your tempo setting might be overwritten when you start or select a song or reset the playback position to the song beginning. If this is inconvenient, you can set to ignore the song-native tempo, giving priority to your custom tempo setting (page 82).

## 4 BEAT

Sets the time signature of the song or click.

□ **Settings:** 1/4-16/4, 1/8-16/8, 1/16-16/16

**NOTE** If your beat setting is different from the song-native one, the click count specified with CLICK 5 will not match at every first beat of the measure. This is not a malfunction, but is a useful technique for counting into a difficult phrase — for example, using a 3/8 count to lead into a 4/4 song. The click count and beat will sync together when you reset the playback position to the song beginning, or when the song-native beat setting is changed during playback.

## 5 CLICK

Sets the beat of the metronome (click count).

□ **Settings:** For a BEAT 4 setting of 3/8, 6/8, 9/8, 12/8, 15/8:

Dotted quarter note, 8th note, 16th note

**For other BEAT 4 settings:**

Quarter note, quarter note triplet, 8th note, 8th note triplet, 16th note, 16th note triplet

**NOTE** You can specify the click tone and its output jack (page 81).

# Playback Controls

Use the transport control for playback of the song or click.

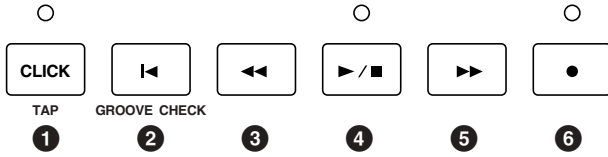

## Click Playback

You can play the metronome click sound solo, or in sync with the current song.

1. Press the **CLICK** button ① to start click playback at the current tempo. The Click indicator will also blink at this tempo.

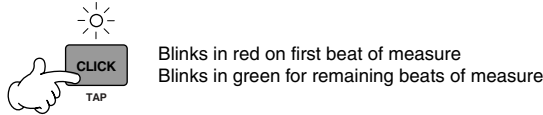

2. Press the **CLICK** button again to stop the metronome click.

**NOTE** If you press the **CLICK** button during song playback, the click will sound in time with the song. If you start song playback while playing the click, the click will start in sync with song playback.

## Song Playback

In addition to the basic start/stop control of the song, the DTXXTREME II's lets control how the song is played, which part is played, and so on.

### Transport Control

1. Press the Start/Stop button ④ to start playback of the current song. The Start/Stop indicator will also light up.
2. Press the Start/Stop button again to stop song playback. The Start/Stop indicator will turn off. If you press the Start/Stop button once more, playback will resume from the stopped point.

While the song is stopped, you can use the following transport buttons to move the playback point:

- 2 **Reset** — to the beginning of the song.
- 3 **Rewind** — to the first beat of the previous measure.
- 4 **Forward** — to the first beat of the next measure.

**NOTE** You can use the Record button ⑥ when you start recording a User song (page 60).

## Song Settings

For specific song settings, you can switch to the song setting display from the default display by pressing the Page button (▼). Here you can specify how you want to play each track, and check other song-related information.

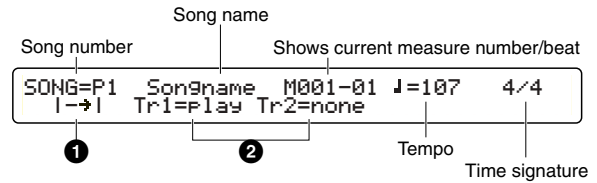

**NOTE** Song-related information is shown in the upper row of the display. Tempo and beat settings are contained in the song. You can temporarily change them from the default screen.

### 1 Playback Method

Determines how the song plays back. In normal playback, the song plays from beginning to end and stops automatically. Repeated playback repeats song playback from beginning to end until you stop it manually.

**Settings:** |→| (normal playback), |↺| (repeated playback)

### 2 TRACK 1 & TRACK 2

Determines whether specific tracks of the song of the song are played or muted. If a track is empty, "none" is displayed and the setting cannot be changed.

**Settings:** play, mute



## About Songs

A song consists of two sequence tracks (Tracks 1 and 2) and header data. The header data at the beginning of the song contains general song information such as tempo and time signature, as well as program change and volume data for each MIDI channel. The data is automatically loaded when you select a song. Each sequence track can contain performance information for MIDI channels 1 to 16, just as with conventional MIDI sequencers. When song playback is started, this data is sent to the built-in tone generator for the sounds to be played back.

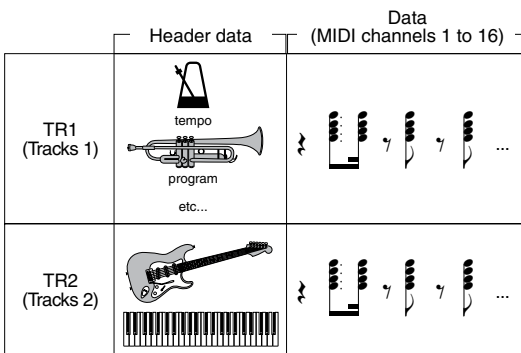

Each song can be played back as a main song or pad song. A main song is a song selected in the default screen and played back with the transport control buttons. A pad song is a song assigned to a trigger input and started or stopped when you hit a pad that is set specifically for that control. Each drum kit can contain pad songs as part of the sound program (page 40), and some Preset kits are provided with pad songs. Since the DTXTREME IIs can play one main song and up to four pad songs at a time, you can play a guitar phrase or a chorded brass hit by hitting pads while playing the drum kit along with the main song.

## Playback Parts

Part selection buttons allows you to enable or disable playback of a specific part (MIDI channel) in the song. For example, you could mute the rhythm part to play rhythms yourself using the pads, or you could play along with just the bass part sounding, or you could jam with an actual bass player with all other accompaniment parts enabled. Indicators for the following buttons show that the corresponding part is enabled (lit) or disabled (unlit). The part is alternately enabled or disabled each time you press the corresponding button.

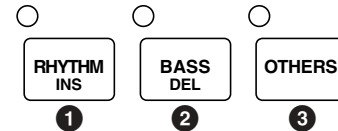

### 1 RHYTHM/INS button

Enables or disables playback of the rhythm part (MIDI channel 10) in track 1 of the song. The rhythm part in track 2 is unaffected.

### 2 BASS/DEL button

Enables or disables playback of the bass part (MIDI channel 3) in the song.

### 3 OTHERS button

Enables or disables playback of parts other than rhythm and bass parts.

**NOTE** DTXTREME IIs uses MIDI channel 10 for the rhythm part, channel 3 for the bass part, and the rest (channels 1, 2, 4 to 9, 11 to 16) for other parts. When the part selection buttons are used to disable the parts, performance data on the corresponding MIDI channels (including data from MIDI IN or USB port) will not be sent to the built-in tone generator.

## Slider Controls

DTXTREME IIs incorporates a simple but powerful mixer. There are ten sliders on the top panel for adjusting the volume balance, reverb effect, and the levels of the Individual Outputs.

### Adjusting the Volume Balance

The following sliders let you control the volume balance between rhythm instruments in the drum kit, and control the volume balance among the drum kit, accompaniment, and click sounds. You can also adjust the output volume of the stereo-mixed sounds independently for the OUTPUT jacks and headphones.

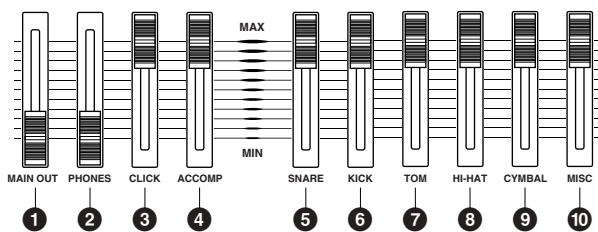

#### 1 MAIN OUT slider

Adjusts the output volume of the stereo-mixed sounds for the OUTPUT (L/MONO & R) and DIGITAL OUT jacks.

#### 2 PHONES slider

Adjusts the output volume of the stereo-mixed sounds for the PHONES jack. The identical stereo signal can be adjusted independently from the MAIN OUT slider 1.

#### 3 CLICK slider

Adjusts the output volume of click sounds from the specified output jack (page 81).

#### 4 ACCOMP slider

Adjusts the output volume of the accompaniment parts (other than MIDI channel 10) in the song. This allows you to adjust the volume balance between the drum kit and accompaniment parts when you play the drum kit along with song playback.

#### 5 SNARE slider

Adjusts the output volume of the snare drum.

#### 6 KICK slider

Adjusts the output volume of the bass drum.

#### 7 TOM slider

Adjusts the output volume of the toms.

#### 8 HI-HAT slider

Adjusts the output volume of the hi-hat cymbals.

#### 9 CYMBAL slider

Adjusts the output volume of other cymbals (ride, crash, etc.).

#### 10 MISC slider

Adjusts the output volume of rhythm sounds other than those listed above.

**NOTE** Each slider control on the top panel works like the fader on a mixer. You can specifically adjust the volume of each accompaniment part as song data (page 72), and the volume of each drum or percussion sound as drum voice data (page 49). You can use the ACCOMP and MISC sliders then to adjust the overall volume for the rest of the parts, while maintaining the volume balance specified in the song and drum kit.

## Adjusting the Reverb Effect

You can control the amount of reverb (system effect) applied to a rhythm instrument by moving the associated volume slider while holding down the SHIFT button. The relevant sliders must be set appropriately to control reverb beforehand (page 75).

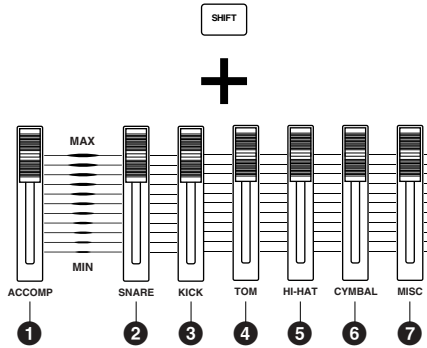

### 1 SHIFT button + ACCOMP/REVERB slider

Adjusts the master return level of the reverb effect.

### 2 SHIFT button + SNARE slider

Adjusts the reverb send level for the snare drum.

### 3 SHIFT button + KICK slider

Adjusts the reverb send level for the bass drum.

### 4 SHIFT button + TOM slider

Adjusts the reverb send level for the toms.

### 5 SHIFT button + HI-HAT slider

Adjusts the reverb send level for the hi-hat cymbals.

### 6 SHIFT button + CYMBAL slider

Adjusts the reverb send level for other cymbals (ride, crash, etc.).

### 7 SHIFT button + MISC slider

Adjusts the reverb send level for rhythm sounds other than those listed above.

**NOTE** Keep in mind that the various settings described above are interdependent; changing a setting may not have the expected effect. For example, there may be little or no reverb sound if you set too small a value for one of the drum voice reverb send level settings (page 53), or if the master send or return level to the system reverb (page 57) is set too low.

## Adjusting the Individual Output levels

You can control the output level from INDIVIDUAL OUTPUT (1 to 6) jacks by simultaneously holding down the SHIFT button and moving the appropriate volume slider. The relevant sliders must be set appropriately to control individual output levels beforehand (page 53).

**NOTE** Drum sounds routed to the Individual Outputs are excluded from the stereo mix, and thus are not output from any of the stereo outputs (PHONES, OUTPUT L&R, DIGITAL OUT).

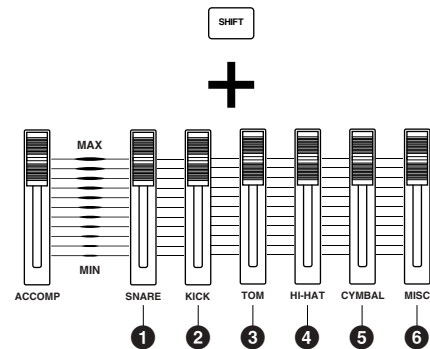

### 1 SHIFT button + SNARE slider

Adjusts the output level for INDIVIDUAL OUTPUT 1.

### 2 SHIFT button + KICK slider

Adjusts the output level for INDIVIDUAL OUTPUT 2.

### 3 SHIFT button + TOM slider

Adjusts the output level for INDIVIDUAL OUTPUT 3.

### 4 SHIFT button + HI-HAT slider

Adjusts the output level for INDIVIDUAL OUTPUT 4.

### 5 SHIFT button + CYMBAL slider

Adjusts the output level for INDIVIDUAL OUTPUT 5.

### 6 SHIFT button + MISC slider

Adjusts the output level for INDIVIDUAL OUTPUT 6.

**NOTE** Since each drum instrument can be freely assigned to any output (page 75), you can adjust the master output level for multiple instruments with a single slider. For example, the CYMBAL slider can become the master fader for all cymbals including hi-hats or only for the snare drum, depending on their output settings.

# Tap Tempo Feature

This convenient function lets you automatically set the tempo by tapping out the beats on a pad or the Audition button. This is especially useful when you want to intuitively set the tempo by “feel” during song playback or click playback.

1. Open the Tap Tempo screen by simultaneously holding down the SHIFT button and pressing the TAP (CLICK) button. While using the Tap tempo feature, the current tempo value is shown in the LED display.

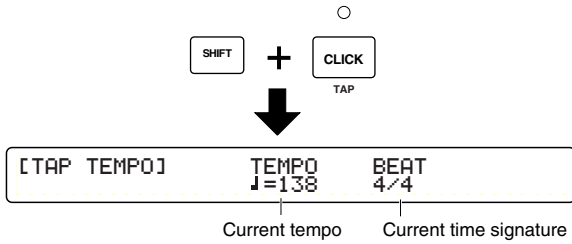

2. Use the knob under the BEAT parameter to set the time signature of a measure. The tempo will be detected for one measure of the time signature specified here.

Settings: 1/4-16/4, 1/8-16/8, 1/16-16/16

3. Count the beat by hitting a pad or the Audition button at a steady tempo, for one measure. If you set a tempo for a 4/4 measure, hit a pad 5 times to count 1st to 4th beat, plus 1st beat of the next measure. Similarly, for a 3/4 measure, hit 4 times to count 1st to 3rd beat, plus 1st beat of the next measure. The tempo is detected from the timing at which you hit the pad, and is shown in the LED display and indicated as a TEMPO value (blinks) in the LCD screen.

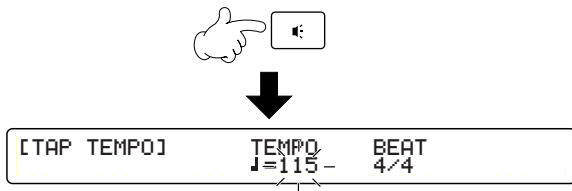

Recognized Tempo Range: 30-300

Tempo detection is done between every other beat to the 1st beat of the next measure. In this way, if you continue tapping, the tempo is determined on every 1st beat of the measure in the 2nd pass and after.

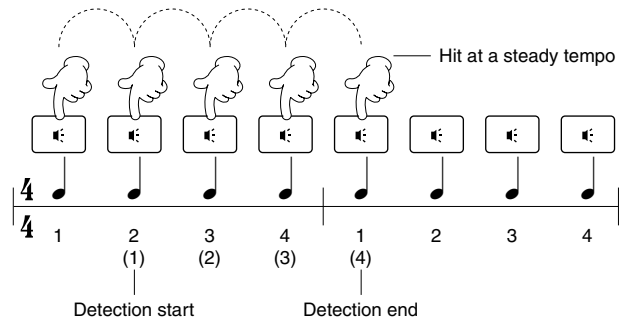

**NOTE** If you do not hit the pad for a certain period, the tempo count is reset. In this case, start counting from scratch (hit 5 times for a 4/4 measure).

4. Press the ENTER/YES button to apply the calculated tempo. The TEMPO value will stop blinking and remain lit.
5. Repeat steps 2 to 4 if you want to restart tempo detection.
6. Press the EXIT/NO button to finish the tempo setting and return to the Play mode display.

**NOTE** The Tap Tempo feature cannot be used during recording or in recording standby.

# Groove Check Feature

When playing the drum kit or tapping the Audition button along with a song or click, you can check how far off your timing is. Specify the length of the note — this is used as the basis for measuring the timing accuracy of your play, to a resolution of 1/96 quarter note.

**NOTE** The Groove Check feature functions only during playback of the song or click.

1. Open the Groove Check display by simultaneously holding down the SHIFT button and pressing the GROOVE CHECK (Reset) button.

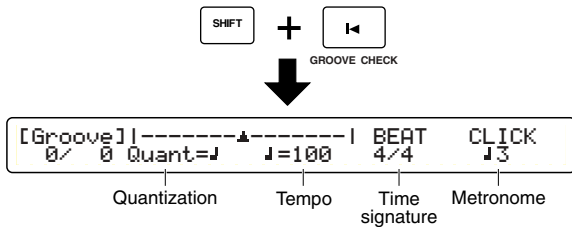

2. Set the desired quantize resolution (expressed as a note length) for the basis of the Groove Check timing. Possible settings are same as the CLICK beat (page 23).

**NOTE** You can check the accuracy of your phrase with complicated subdivisions by setting a different note length from the CLICK beat.

3. If necessary, set the TEMPO, BEAT and CLICK values as in the default display (page 23).

4. Play the drum kit or hit the Audition button in time with song playback or click count. The timing difference for each hit is displayed both graphically and as a numerical value.

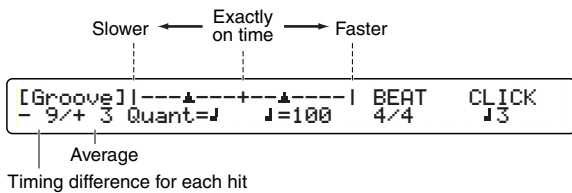

**Timing difference for each hit:** The difference in timing accuracy each time you hit a pad or drum is displayed as a number in the range of -48 to +48 (slower to faster).

A negative value means you are playing slower than the song tempo, and a positive value means you are playing faster. A value of zero means you are playing exactly on time. This is useful to measure the timing tightness of a specific instrument such as the snare or bass drum.

**Average:** The difference in timing accuracy is measured as an average and displayed as a number in the range of -48 to +48 (slower to faster). A negative value means you are playing slower than the song tempo, and a positive value means you are playing faster. A value of zero means you are playing exactly on time. This is useful for checking the overall tightness of your drumming.

5. Press the EXIT/NO button to finish groove checking and return to the Play mode display.

# Chain Feature

A Chain is a series of drum kits and songs arranged in the order you want. For example, you can arrange different drum kits to be selected in a specific order — for example, to match that of a set list in a live performance, or to use with a series of practice songs arranged in order of difficulty. The DTXTREME IIs can memorize up to 32 chains for instant recall them whenever you want them.

## Switching the Chain Display

When pressing the CHAIN button, the Chain Play display appears first, allowing you to play existing chains. Pressing the CHAIN button again calls up the Chain Edit display, from which you can create a new chain or edit an existing one. Every press of the CHAIN button toggles between these two displays. When you finish using this feature, simply press the EXIT/NO button to return to the default display.

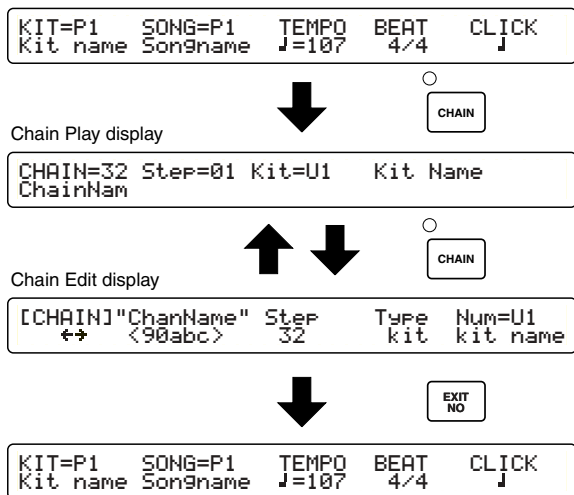

# Creating or Editing a Chain

The first step in using chains is to create one. You can also freely edit an existing chain at any time. Once you create or edit a chain, you'll need to store it BEFORE you start working with another chain.

**NOTE** Select a target chain in the Chain Play screen beforehand (page 32).

## Chain Edit Screen

Here you can arrange drum kits or songs one by one to each step in a chain. A chain can contain up to 32 steps, and you can link a chain to another if you want a long chain that exceeds 32 steps or a looped chain that repeats a specific series.

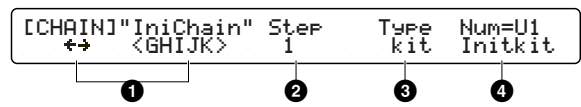

### 1 Chain Name

Enter the desired name for the current chain, using up to eight characters. Use the leftmost knob to move the entry position (cursor) for each character. Then, use the second-to-left knob to enter a character at that position. Repeat this step and specify the chain name (maximum of eight characters).

#### Available characters:

!	"	#	\$	%	&	'	(	)	*	+	,	-	.	/	0	1	2	3	
4	5	6	7	8	9	:	;	<	=	>	?	@	A	B	C	D	E	F	G
H	I	J	K	L	M	N	O	P	Q	R	S	T	U	V	W	X	Y	Z	[
¥	]	^	_	`	a	b	c	d	e	f	g	h	i	j	k	l	m	n	o
p	q	r	s	t	u	v	w	x	y	z	{		}	→	←				

### 2 Step

Select a step number (1 to 32) to which a drum kit or song is to be assigned. You can set up to 32 steps for a chain.

### 3 Type

Specify what you want to assign to the currently selected step (in Step 2 above). Available settings are: drum kit (kit), song (song), linking to another chain (jump), and end mark at this step (END).

□ **Settings:** song, kit, jump, END

**NOTE** If you make a chain with a jump point on the way to the final step, the chain will not play the steps after the jump point.

**NOTE** If you specify neither jump or END within a chain, it will continue playing to the 32nd step. To effectively use the chain, set jump or END at the final step.

### 4 Num=

Specify the item according to the Type 3 setting made above. Select a drum kit for kit, a song for song, or a destination chain for jump. You can view the number in the upper row and the name in the lower row. If you set the current chain for the destination, you will have a looped chain. You do not need set anything for END, since the display shows “---” (no setting).

□ **Settings:** When Type 3 is set to song: Preset or User song  
When Type 3 is set to kit: Preset or User drum kit  
When Type 3 is set to jump: 1-32 (chain)

**NOTE** If you select a drum kit or a song on the memory card (C1-C99 for each), you'll need the appropriate memory card containing the relevant drum kit or song data for correct playback of the chain. Otherwise, “No Card” is shown in the display.

## Procedure

Create or edit a chain referring to above explanations concerning each item in the edit screen.

**NOTE** In the Chain Edit screen, a dot appears in the LED display. This means you have edited the chain but not yet stored it. If, while editing, you switch to Chain Play display and select another chain, your edits will be lost (the LED dot will go out). Be sure to save necessary edits before selecting another chain.

1. Use the two left knobs to specify the chain name.
2. Use the center knob to select a step, and then use the two right knobs to set the type and number for the step.
3. Specify other steps in the same manner.
4. Press the STORE button to save this chain.

```
Store Current Chain to chain
                        10 My Chain
```

5. Use the second-to-right knob to select a chain number (1 to 32), to which the current chain you've created or edited will be stored.
6. Press the ENTER/YES button. A confirmation message will appear in the display.

```
Store Current Chain to chain
Are You Sure ? [Yes/No]
```

7. Press the ENTER/YES button again to execute the store operation, or press the EXIT/NO button to cancel.
8. When the chain is successfully stored, the display shows “Done.” for a second and returns to the Chain Play display. When the store operation is cancelled by using the EXIT/NO button, you can continue editing if you want.

## Playing a Chain

To play back a chain, simply turn the knob to select each step. You can also select a step while playing the drum kit by increasing/decreasing the step number with a pad (page 77) or a foot switch (page 46).

### Chain Play Screen

Once you create a chain, play it from the Chain Play display.

```
CHAIN=1  Step=1  Kit=U1  Init Name
IniChain
```

#### 1 CHAIN=

Select the desired chain.

☐ **Settings:** 1-32

#### 2 Step=

Select a step number for the current chain ①, which calls up the drum kit or song assigned to that step (the name and number appears at the right).

Kit=xxx xxx, Song=xxx xxx.

☐ **Settings:** 1-32 (depending on each chain)

## Procedure

In addition to the panel knob, you can assign increment and decrement functions respectively to two different switching devices — pads (page 77), foot switches (page 46), or a combination of pad and foot switch, making it possible to select each step in the chain even while playing the drum kit.

1. Use the leftmost knob to select the chain you want to use.
2. Use the left-to-second knob, pad, or foot switch to select a step and recall a drum kit or song.
 

**NOTE** If the selected step is a jump point, it calls up the drum kit or song assigned to the first step of the linked chain.
3. Play the drum kit or song that is recalled.
4. As desired, select the next step in the same manner and call up another drum kit or song for playing.



# Edit Section

## DTXTREME IIs as Drum System

Because of their quick decay and non-pitched nature, drum and percussion instruments are ideal for electronic music. Rhythm machines and samplers make it easy to use actual instrument sounds and assemble the rhythms in authentic, dynamic ways. However, programming of drum sounds to realistically reproduce the natural energy, feel, groove and dynamics of the original is very difficult to do. Most musicians feel that there is nothing like “pounding out” the rhythm on a set of drums to get the proper quality of “comfortable randomness.” Hit and sound, and repeat this to create a rhythm — this primitively simple process produces a very humanized performance. Our research and development was focused on that point — a entirely new fusion of acoustic and electronic instruments. The answer is DTXTREME IIs. Converting what a player intends to represent through drumming into trigger signals, and linking them to MIDI, an industry standard for electronic musical instruments, DTXTREME IIs enables a creative rhythm-oriented musical performance beyond what you can expect from traditional acoustic drums.

### From Trigger Input to Sound Output

Before getting deep inside the DTXTREME IIs system, let’s take a look at its mechanism, structure, and basic ideas.

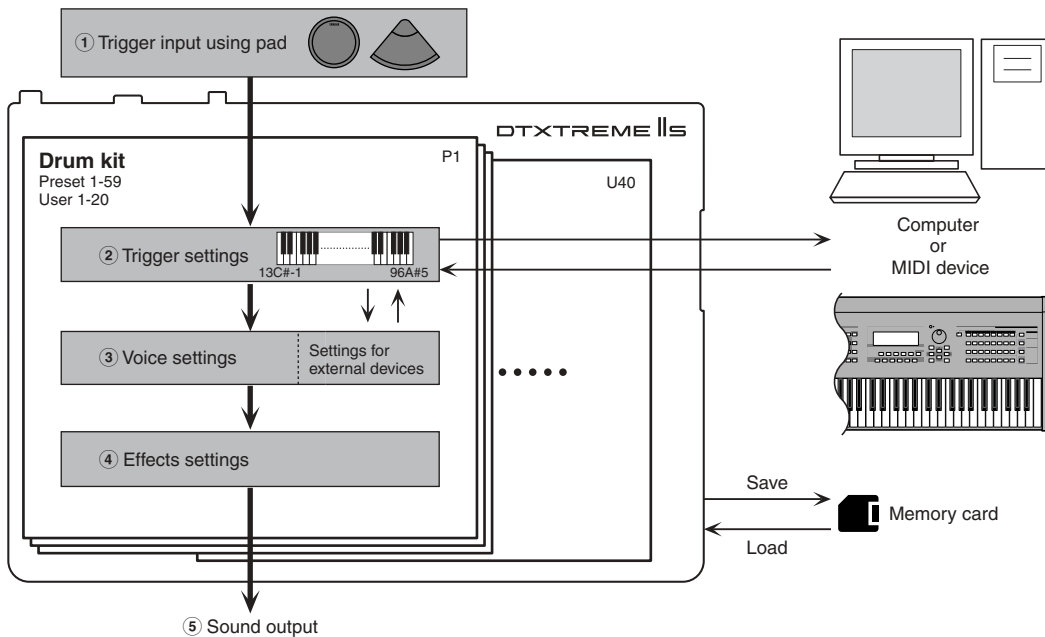

- ① Send trigger signals to the DTXTREME IIs by hitting drum pads (or drums attached with a trigger pickup) connected to the trigger input jacks 1 to 16 and the HI-HAT CONTROL and FOOT SW jacks.
- ② Set each trigger input properly so that DTXTREME IIs can receive the trigger signals, and also assign a specific function to each trigger input. You can assign songs (pad song) or note numbers other than those of MIDI channel 10 (rhythm and drum part) for a variety of performances.
- ③ Assign a drum voice to each note number of MIDI channel 10 (rhythm and drum part) so that you can play a drum voice by hitting a drum pad. You can also specify how each drum voice will sound (volume, pan, etc.) in the kit. Optionally, you can activate MIDI settings for other parts when you choose the drum kit.
- ④ Set system effects applied to the entire drum kit, and insertion effects applied to specific drum voices.
- ⑤ Sound out drum and other voices as audio signals, according to the above settings ② to ④.

The above settings ② to ④ in combination are referred to as a drum kit — just as is indicated on the panel, with the three buttons TRIGGER, VOICE, and EFFECT outlined by DRUMKIT. When you press one of these buttons, you can start editing that part of the current drum kit. Your drum kits can be stored as up to 40 User kits (U1 to U40) in the DTXTREME IIs memory, or up to 99 User kits (C1 to C99) to an external memory card.

# Memory, Buffer, and Store Operation

When editing a drum kit, you need to be aware of the relationship between the storage memory and the working buffer. Every time you select (recall) a Preset kit or a User kit from the DTXEXTREME II's internal memory or an external memory card, the drum kit data is copied to the working buffer.

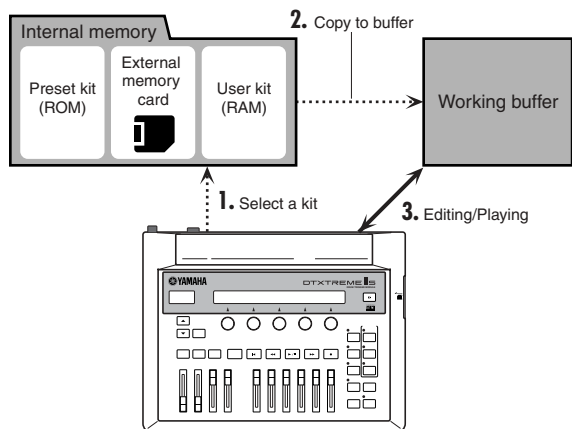

**NOTE** Because of the working buffer, you can select and edit any drum kit even when it is a Preset kit (read-only data). When creating your original drum kit, first select an existing Preset or User kit, edit it, and then store as a new User kit.

Drum kit data in the buffer will be used for everything — for your performance or for editing. Once you edit any data (change the data from its stored status), the rightmost dot in the LED display will light.



**NOTE** The LED display may show the current tempo (page 76).

If you select another drum kit at this point, the dot will go out. This means other drum kit data is newly copied to the working buffer, overwriting the drum data you were working with. If you wish to save what you edited, make sure to do so BEFORE selecting another drum kit.

To save the current drum kit data, execute the store operation by pressing the STORE button.

STORE



Store Current Drumkit to Kit  
C001 Initkit

When the above screen is shown, select the destination User kit number (U1 to U40, or C1 to C99) where your current data is stored. You do not need to select a new destination if you edit an existing User kit and overwrite it with edited data. However, if you edit one of Preset kits (P1 to P90) and want to store a new drum kit, you need to specify a User kit number in the internal memory (U1 to U40) or on the memory card (C1 to C99). After selecting the destination, press the ENTER/YES button. The following confirmation message will appear in the display.

ENTER YES



Store Current Drumkit to Kit  
Are You Sure ? [Yes/No]

**NOTE** If you select C1 to C99 with no memory card inserted to the CARD slot, "No Card" will be shown and the store operation cannot be continued. Insert a proper memory card (page 85) or store the data to internal memory.

Press the ENTER/YES button again to execute the store operation. When complete, "Done." will be shown briefly. Press the EXIT/NO button to cancel the operation. In either case, the display will return to the default Play mode screen. Note that the dot in the LED display goes out after you execute the store operation.

You can store the current drum kit any time during editing. Save your edits often — frequent updates ensure that your important data is maintained.

# Trigger Settings

Press the TRIGGER button on the top panel, designated by DRUMKIT, to start editing trigger settings for the drum kit you are working with.

**NOTE** Trigger settings are the most important part for your drum kit to sound various voices properly. If necessary, first copy existing trigger settings (page 44) from a Preset kit that are similar to what you want, then edit them for your original kit.



[TrgSens1]	Type	Gain	Curve	PadCtrl
Input=1	RHP	32	3_-----	Pitch

**NOTE** The first page that appears (the one last called up) may be different from the display shown above (page 76).

## Edit Pages and Basic Operations

Trigger settings are available in the following seventeen pages, categorized by purpose and function.

Page name				
[TrgSens1]	Type	Gain	Curve	PadCtrl
Input=1	RHP	32	3_-----	Pitch
[TrgSens2]	Level(100%)	Velocity(127)		
Input=16	20% to 100%	32 to 127		
[TrgSens3]	SelfRej	Rej	Spec Rej	
Input=16	6ms	4	9 from IN16	
[TrgFunc]	Func	Song	Repeat	Mode
Input=16	padsong	P1	off	cutoff
[TrgMIDI1]	Mode	TrgAltG	RimVel	
Input=16	stkmono	16	-----	
[TrgMIDI2]	Note	Note#	GateTime	Channel
Input=16	4th	*88 E5	0.3s	10
[TrgMIDI3]	Note	VelXFade		
Input=16	1st	1-		
[TrgCopy1]	Input	Kit	Input	
	from 16	to current	16	
[TrgCopy2]	Copy	Current	Trigger	to Kit
				U1
[MIDI EG]	Curve	Time	MIDI	Type
	3/4	32	10ch	Ctl 16

[FootCtl1]	Func	Sens		
	HiHat	16		
[FootCtl2]	HHInput	MIDI	Type	
	IN8	10ch	Ctl	4
[FootSw1]	Func	Velocity	MIDI	Type
	HiHat	111	10ch	Ctl127
[FootSw2]	OnValue	OffValue		
	127	127		
[COMMON1]	Volume	WaveDir		
	127	No card		
[COMMON2]	Song	Tempo	9to10	11to12
	P1	200	off	off
[KitName]	Name	"Acoustic"		
	↔	<90abc>		

In the first seven pages you can set up each trigger input on the DXTREME II's rear panel. This means you actually have seven pages for each of the sixteen inputs. However, you can easily switch to other inputs by turning the leftmost knob, while staying in the same page. This is also useful for comparing settings of the current input with others.

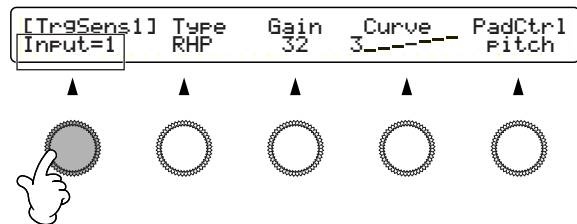

**NOTE** You can also select the target input by hitting the corresponding pad (page 76), which is more convenient if you make fine tuning settings of your drum kit while playing.

Also, refer to "Basic Operations" on page 20.

## [TrgSens1] & [TrgSens2] Trigger Basics

These two pages contain settings to set how your playing strength (trigger signal level) is converted into velocity for MIDI Note On events. In general, hitting the pad hard produces a large velocity value, and the resulting voices sound loudly.

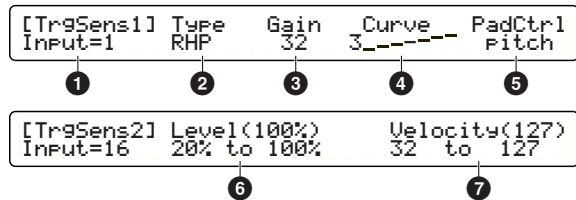

### 1 Input=

Select a target trigger input (1 to 16).

### 2 Type

Select the pad type for the target input **1**. The list below shows the pad types that can be set for the connected pads or trigger pickups.

❑ **Settings:** Refer to the following table.

#### DTXTREME IIs Pad Types

KP	KP65/60/80S/80
TP-1/Snr	TP120SD/100 (*1)
TP-1/Tom	TP120SD/100 (*1)
TP-2/Snr	TP65S (*1)
TP-2/Tom	TP65S (*1)
TP-3	TP80S/80/65/60 (*2)
RHP	RHP120SD/120/100/80
RHP Kick	KP120
PCY-1	PCY150S
PCY-2	PCY130S/130/65S/65/80S/80
PCY-3	PCY80S/80/65S/65/60/10
RHH	RHH130 (*3)
BP	BP80
DT Snare	DT10/20 drum trigger for snare drum
DT HiTom	DT10/20 drum trigger for high toms
DT LoTom	DT10/20 drum trigger for low toms
DT Kick	DT10/20 drum trigger for bass drum
TRG Snr	Generic trigger pickup for snare drum
TRG HTom	Generic trigger pickup for high toms
TRG LTom	Generic trigger pickup for low toms
TRG Kick	Generic trigger pickup for bass drum

- \*1 “TP-1/Snr” and “TP-2/Snr” set more sensitivity to the rim 2 for easy closed rimshot play.  
“TP-1/Tom” and “TP-2/Tom” set the same sensitivity to both rims 1 and 2.
- \*2 “TP-3” will produce a voice assigned to the rim 1 when the pad rim is hit.
- \*3 “RHH” also supports the TP65S pad.

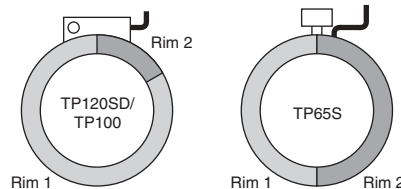

### 3 Gain

Set the input gain for the pad type **2**. The larger the value, the more sensitive the pad becomes.

❑ **Settings:** 0-63

### 4 Curve

Set the velocity curve for the change of trigger signal levels. For larger values, the pad must be hit harder to produce the loudest sound.

❑ **Settings:** 1-5

### 5 PadCtl

When using a TP120SD or TP100 pad for the snare drum or tom (connected to trigger inputs 1 to 6), you can use the pad controller to adjust the drum tone. Specify a voice parameter (page 48) adjusted by the pad controller. Select a value that ends with an “R” letter, for simultaneous control for both pad and rim 1 voices.

❑ **Settings:** off (no effect), pitch (R) (Tuning), volume (R), voice (R), pan (R), layer (R), filter (R), Q (R), attack (R), decay (R), decay R+ (see note), wave 1 (Layer 1 voice)\*, wave 2\*, XSfilter\*, XSdecay\*, balance\*

\* Controllable when Type=XtrSnr is selected in voice settings.

**NOTE** The decay+R value can continuously adjust the voice decay rate and switch to another specific voice (strainer-off tone for the snare drum, for example) at a minimum setting.

**NOTE** You can select any parameter here, but actual effect by the pad controller depends on the drum voice selected in the voice settings.

## 6 Level

Set the range of trigger levels for the target input 1, as minimum and maximum values. Trigger levels within the specified range are accordingly converted into velocity values. If the trigger signal is below the minimum level, no sound is output. If the trigger signal exceeds the maximum level, it will be converted into the maximum velocity, specified with the Velocity 7 parameter. When you hit the pad, the trigger level is displayed as a percentage to the right of Level.

Settings: Minimum level: 0-99, Maximum level: 1-100

## 7 Velocity

Set the range of velocity values that corresponds to the Level range 6, as minimum and maximum values. The drum voice will sound in the specified velocity range. When you hit the pad, the converted velocity value is displayed to the right of Velocity.

Settings: Minimum velocity: 0-126, Maximum velocity: 1-127

**NOTE** Setting a high minimum velocity will produce a loud sound when you hit the pad lightly. However, this will narrow the dynamic range and reduce the amount of expressive control you have over the volume change.

## Relationship between Trigger Level and Velocity

### Ex. 1

In this illustration, velocity values are output for trigger levels between 12% and 99%. For a trigger level of 12%, the velocity is 001. For a trigger level of 99%, the velocity is 127.

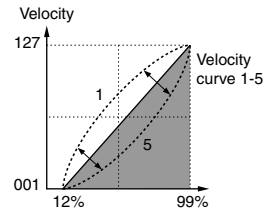

### Ex. 2

In this illustration, velocity values are output for trigger levels between 50% and 99%. For a trigger level of 50%, the velocity is 064. For a trigger level of 99%, the velocity is 127. No sound is produced (velocity value of zero) for trigger levels between 0% and 49%.

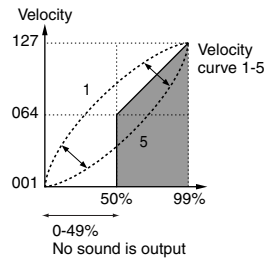

**NOTE** This “trigger level to velocity” conversion is also applied to the rim velocity (velocity output from the pad rim; page 41). When you use a pad rim for cymbal muting, the trigger level generated by holding the rim will be converted to a velocity value of zero.

## [TrgSens3] Rejection

This page contains three different settings to prevent “false hits” — such as double triggering caused by stick rebound, or crosstalk caused by pad vibration or interference between trigger inputs. Trigger signals detected as such false hits do not produce any sounds.

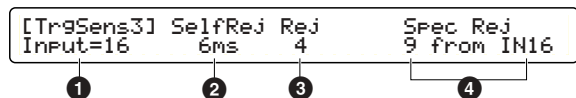

### 1 Input=

Select a target trigger input (1 to 16).

### 2 SelfRej

Use this to avoid double triggering caused by the target input **1** itself, produced by stick rebound. If there are 2 trigger signals is generated at the input **1** within the specified period here, the second signal is detected as double triggering.

□ **Settings:** 5ms (milliseconds) -10.0s (seconds)

### 3 Rej

Use this to avoid crosstalk caused by vibrations while playing the drum kit. If a trigger signal is generated at the target input **1** and its level is lower than specified here, that trigger signal is detected as crosstalk.

□ **Settings:** 0 (no rejection) -9

### 4 Spec Rej

Use this to avoid crosstalk caused when hitting a specific (interfering) pad. If a trigger signal at the target input **1** is generated with a level lower than specified here, after the trigger signal at the interfering input specified here, the trigger signal at the input **1** is detected as crosstalk.

□ **Settings:** Level: 0 (no rejection) -9, Input: IN1-IN16

**NOTE** Use the two right knobs for setting the level and interfering trigger input.

## [TrgFunc] Trigger Function

Besides triggering a drum voice, drum pads connected to the trigger inputs can be used for various controls. Since this control function can also be assigned to the pad rim, you can play the head of the pad normally while using the rim to control a parameter or function. Keep in mind that a pad rim or head that is assigned to a control function cannot also be used to trigger a drum sound.

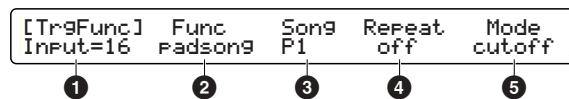

### 1 Input=

Select a target trigger input (1 to 16). For trigger inputs 1 to 8, you can select from two rims (1R1, 1R2, ..., 8R1, 8R2).

**NOTE** Rim settings are effective with a dual trigger pad. In the Pad-to-Input Matching Chart (page 16), for combinations indicated by “A (Best)” or “B (Good),” you can use up to two rims. You cannot use the pad rim for “C (Fair)” combinations.

### 2 Func

Select the function of the target input **1**. This specifies what you can trigger by hitting the drum pad or rim.

□ **Settings:**

- normal: Plays a drum voice and outputs MIDI events.
- padsong: Controls a pad song. Specify a song with the parameters **3**-**5**.
- click: Enables or disables the click.
- inc: Increment — selects the next drum kit in the Play mode display, or selects the next step in the Chain Play display.
- dec: Decrement — selects the previous drum kit in the Play mode display, or selects the previous step in the Chain Play display.
- bypass: Temporarily disables trigger inputs other than the target input **1** (page 37).
- strt/stp: Controls playback of the main song (same as Start/Stop in the transport control).
- MIDI EG: Outputs Control Change data continuously (page 44).

## Setting a Pad Song

You can play up to four pad songs from one drum kit. If you have already specified four pad songs for other trigger inputs, the following parameters ③-⑤ cannot be set and “---” is shown in the display.

### ③ Song

Select a song for the pad song. You cannot choose a song from the memory card.

**Settings:** Preset or User song

### ④ Repeat

Enable or disable repeated playback of the pad song.

**Settings:** on (enabled), off (disabled)

### ⑤ Mode

Specify how you want the pad song to play back.

**Settings:**

- play: Song playback will start or stop each time you hit the pad. Song will always play from the beginning.
- chase: Each time you hit the pad, the song will play one measure and automatically stop. If you hit the pad during playback, the song will resume playback from the next measure.
- cutoff: Song playback will start or stop each time you hit the pad. If you start a different pad song during playback, the current song will stop.

**NOTE** When you play multiple songs (main song and pad songs) with one drum kit, keep in mind the MIDI channel assignments for those songs. You may get unexpected and confusing results if different data in two or more songs share the same MIDI channel.

## [TrgMIDI1] Key On Mode

In this page you can specify how MIDI Note On events will be triggered when a pad is hit. Triggering by hitting a pad can be associated with pressing a key on the keyboard, and a triggered note will sound according to a specific rule. This rule is called the Key On mode.

[TrgMIDI1] Mode	TrgAltG	RimVel
Input=16	stkmono	16
1	2	3
		4

### ① Input=

Select a target trigger input (1 to 16). For trigger inputs 1 to 8, you can select from two rims (1R1, 1R2, ..., 8R1, 8R2).

**NOTE** Rim settings are effective with a dual trigger pad. In the Pad-to-Input Matching Chart (page 16), for combinations indicated by “A (Best)” or “B (Good),” you can use up to two rims. You cannot use the pad rim for “C (Fair)” combinations.

### ② Mode

Specify the Key On mode for note numbers (page 42) assigned to the target input ①.

Each of the trigger inputs 1 to 16 (except for rims) can be assigned to play up to six notes simultaneously (stack mode), or up to nine different notes played in turns (alternate mode). Each of these has two different modes, mono and multi. In mono mode, previously triggered notes will be muted by newly triggered ones.

**Settings for other than rims** (R1 and R2):

- stack: Stack & multi mode.
- alter: Alternate & multi mode.
- stkmono: Stack & mono mode.
- altmono: Alternate & mono mode.
- hold: A variation of stack & mono mode, letting notes triggered by hitting the pad continue sounding until you hit it a second time.

**NOTE** If you only trigger a drum voice by hitting a pad, and do not play either a chord (stacked notes) or a phrase (alternate notes), select a multi mode (stack or alter) here. If you select a mono mode, it will cut off notes triggered continuously, producing unnatural sounds.

There are three Key On modes for rims: Single mode, which is suitable for closed rimshots (cross sticking); hold mode, which is for sounding a rim voice as long as you want; and withpad mode, which is suitable for open rimshots.

**Settings for rims** (R1 and R2 only):

- single: Plays a drum voice assigned to the rim of the target input ①.
- hold: A variation of single mode, letting a rim voice triggered by hitting the rim continue sounding until you hit it again.
- withpad: Simultaneously plays a drum voice (and other stacked or alternate notes) and a rim voice for the target input ① each time you hit the rim.



**NOTE** Withpad mode does not demand that you play a real open rimshot (hitting the pad rim and head at the same time). It lets you play both the pad and rim sounds by only hitting the rim.

### 3 TrgAltG

Specify the trigger alternate group number to which the target input **1** belongs. If multiple trigger inputs are grouped with the same number assigned, only one input from that group is enabled at a time. As a result, hitting a pad from that group will mute notes triggered by other pads in the same group. This is useful to prevent an unnecessary stacking of notes.

□ **Settings:** off (not grouped, default), 1-32

**NOTE** This function works in conjunction with the RvKeyOff setting (page 52) for a drum voice associated with the trigger input (by MIDI note number). When a trigger input is enabled from a trigger alternate group, other trigger inputs from the same group respectively generate a MIDI note off event for the corresponding MIDI note number. This note off event is then sent to the internal tone generator and is used to mute a drum voice assigned to that MIDI note number. If this voice is set to receive the Note Off event (RvKeyOff=on), you can successfully mute its sound by the trigger alternate group setting. Otherwise (RvKeyOff=off), you cannot mute it even though the Note Off event is generated and sent to the tone generator.

### 4 RimVel

This parameter is available only when a rim (1R1 to 8R2) is selected for the target input **1**, and determines how to output the rim velocity. The “trigger level to velocity” conversion (page 37) for the target input **1** is applied to all settings other than the fix settings.

□ **Settings:**

- mute hi: Outputs a velocity value according to how hard you hit the rim. When you hit (hold) the rim with strength below a certain level, a velocity value of zero is output and produces the muting effect. Select this if you connect a cymbal pad to the target input **1**.
- mute lo: Same as mute hi, but the muting sensitivity is lowered. If you cannot easily get the muting effect with mute hi, select this setting.
- variable: Outputs a velocity value according to how hard you hit the rim. Select this if you connect a drum pad to the target input **1**.
- fix1-fix127: Outputs a fixed velocity value regardless of how hard you hit the pad. However, you cannot use the muting effect with one of these fixed values.

**NOTE** If you connect and specify an RHP-series real head pad to the target input **1**, mute hi or mute lo for the rim velocity **4** will be shown in brackets. This means the trigger input and the pad type do not match, therefore the muting effect is disabled.

## [TrgMIDI2] Note On Event

After you’ve specified how the trigger signal is converted into a velocity value (page 38), and how to produce a triggered sound (page 40), now go on to this page and specify the note for that sound with its pitch and length (note number and gate time), as well as the MIDI channel assignment. This determines a specific MIDI Note On event (consisting of channel, note number, and velocity) output when you hit a pad. Again, in this page, you can specify up to nine notes (including the basic note for a drum voice) according to the specified Key On mode, up to two notes for rims, and an optional note for muting respectively, by note number, gate time, and MIDI channel.

[TrgMIDI2] Input=	Note	Note#	GateTime	Channel
16	4th	*88 E5	0.3s	10

1
2
3
4
5

#### 1 Input=

Select a target trigger input (1 to 16).

#### 2 Note

Select a target note (1st to 9th for an alternate mode, 1st to 6th for the stack mode), rim notes (rim1, rim2), or a mute note.

When selecting the trigger input **1** for hi-hats (page 45), five notes are available for hi-hats instead of the 1st to 9th notes:

- open: For an open hi-hat sound by hitting the pad.
- clse: For a closed hi-hat sound by hitting the pad.
- fcls: For a foot-closed hi-hat sound.
- spls: For a foot-splashed hi-hat sound.
- clsRim: For a rim sound by hitting the pad while the hi-hat pedal is depressed.
- opRim1: For a rim1 sound by hitting the pad while the hi-hat pedal is released.
- opRim2: For a rim2 sound by hitting the pad while the hi-hat pedal is released.

**NOTE** The mute note setting is a powerful performance feature that lets you mute the sound played by the pad, simply by touching/hitting the edge or rim. More than that, it also lets you play a second sound. For example, you could perform a cymbal “choke” by grabbing the edge of a cymbal pad — and at the same time have a reverse cymbal or other sound play.

### 3 Note#

Assign a note number for the note 2 of the target input 1. Since the note number is shown with its note name (key and octave), both will change accordingly as you turn the associated knob. Also refer to the column below for more about the note number.

#### Settings:

- off: Use this as end mark for the phrase. If you play a six-note phrase by setting to an alternate mode, set the 7th note to off. This enables you repeat the phrase by continuously hitting the pad. For stack modes, this setting has no effect.
- note number: Note numbers below 13 (C#-1) or above 94 (A#5) are shown in brackets. This means they will be output as MIDI events, but will not play sounds from the built-in tone generator.
- skip: Available only for alternate modes. Use this as a rest mark for the phrase. This enables you play a phrase containing rests by repeatedly hitting the pad.

**NOTE** An asterisk (\*) displayed to the left of a note number means that the same note number for MIDI channel 10 has been assigned elsewhere, warning you that the same drum voice would be triggered from multiple pads. For your information, copying trigger settings from a Preset kit (page 44) ensures that the 1st note for each trigger input will sound a proper drum voice (e.g., bass drum for KICK, etc.).

### 4 GateTime

Set a gate time (note length) for the note number 3 to match the note length with the drumming or main song tempo, or to naturally sound a phrase containing rests. For the note on the channel 10 5 (drum voice), its note length is determined in conjunction with the voice settings (page 52).

Settings: 0.0s-9.9s (in 0.1s increments), =1st

**NOTE** For triggering a chord (multiple notes in a stack mode), you can easily set the same gate time to all notes. Set any necessary gate time to the 1st note, then set the same value to the rest of the notes.

### 5 Channel

Set a MIDI channel for the note number 3. This channel will be used for both transmission and reception. You can use this channel for playing the built-in tone generator from an external MIDI controller, as well as sending the Note On event to an external sound module by hitting the pad.

Settings: 1-16, =1st (same as GateTime, convenient for triggering a chord or a phrase)

## Setting the Note Numbers

MIDI note numbers are used to specify the pitch of a sound. Middle C, for example, is note number 60. In general, each note is indicated by its name and octave, such as C3 for middle C. So the note an octave above C3 is C4, and the note number is 72.

This standardization makes things easier when playing notes on an external sound module.

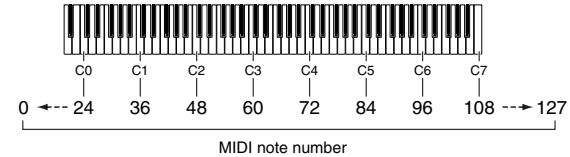

You can easily set multiple note numbers for a chord or a phrase in the [TrgMIDI2] page (only available in this screen).

## Using a Chord Name

To call up the following page, simultaneously hold down the SHIFT button and press the Rewind button.

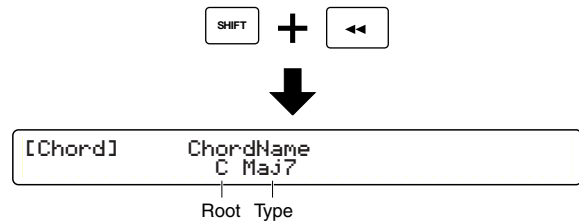

Use the second-to-left and center knobs to specify a chord by its root and type. Also, you can automatically set the chord to the current trigger input, using up to five note numbers.

#### Settings:

- Root: C, C#, D, D#, E, F, F#, G, G#, A, A#, B
- Type: Maj7, Maj, 6th, m7(11), Maj9, add9, min, min6, min7, m7(b5), mM7, min9, madd9, 7th, 7(#5), 7(b9), 7th9, 7(#9), 7(#11), 7(b13), 7(13), 7sus4, sus4, dim, aug

After you've selected a chord, press the ENTER/YES button. An "Are You Sure?" confirmation message will appear in the display. Press the ENTER/YES button again to actually set the note numbers. Press the EXIT/NO button to cancel the operation. When you return to the previous page, try hitting the pad. You can play the chord in a stack mode, or arpeggio in an alternate mode.

## Using an External MIDI Keyboard

You can assign a note or multiple notes such as a chord using an external MIDI keyboard connected to MIDI IN on the rear panel. Select the 1st note ② and then play the desired chord on the MIDI keyboard. The chord you play is automatically divided and programmed into individual numbered notes in played order (1st to 6th for stack modes, 1st to 9th for alternate modes).

**NOTE** If you select a note other than 1st, only the first note (of a chord) you play will be assigned to that note.

## Viewing the Current Assignments

Press the SHIFT and TRIGGER buttons simultaneously to call up the following page,

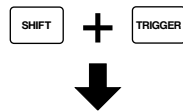

```
I=10  1. C#-2  2. D-1  3. E0  4. ---  5. ---
altm  6. ---  7. ---  8. ---  9. ---  m. E#0
```

Use the leftmost knob to specify the trigger input. Now you can view the Key mode setting (page 38) under the specified input, and note numbers for "1" to "9" and "m" (1st to 9th, mute) positions, by its name and octave.

## [TrgMIDI3] Velocity Crossfade

We've seen earlier how to convert the trigger signal into a specific velocity value, and you can guess that setting when applied to chords results in each note of the chord sounding with the same volume. In this page, you can set a velocity crossfade curve for each note triggered, applying a kind of natural randomness to the velocity of the notes in the chord.

```
[TrgMIDI3] Note  VelXFade
Input=16  1st  1
```

①            ②            ③

**NOTE** For above reasons, settings in this page are enabled when the trigger input is set to the stack mode (page 40). In the alternate mode, each note can be triggered in turn with a different velocity value.

### ① Input=

Select a target trigger input (1 to 16).

### ② Note

Select a target note (1st to 6th).

□ **Settings:** 1st, 2nd, 3rd, 4th, 5th, 6th

**NOTE** You can select other notes, but cannot set the velocity crossfade value ③ when "----" is shown.

### ③ VelXFade

Set a velocity curve (volume curve) for the note ②, to the pad playing strength (softly to hard). For example, you could set Curve 2 to the 1st note and Curve 3 to the 2nd. In this case, the 1st note will sound louder when you play more softly, and 2nd note will sound louder when you play harder.

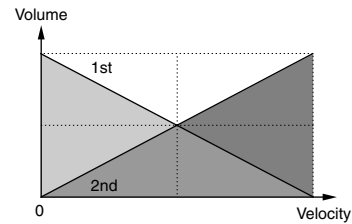

□ **Settings:** 1-10

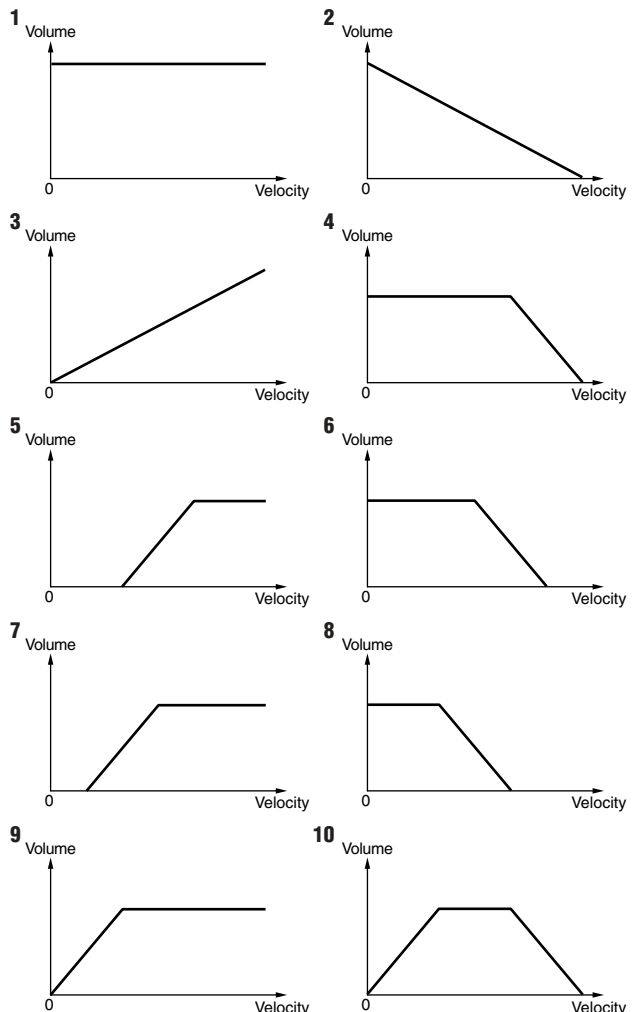

## [TrgCopy1] & [TrgCopy2] Trigger Copy

You can copy trigger settings to create a drum kit for a similar configuration of pads. Use the [TrgCopy1] page to copy settings from a specific trigger input. Use the [TrgCopy2] page to copy setting from the drum kit you are currently working (editing) with. Either copy operation is done simply by selecting a target and pressing the ENTER/YES button.

### Copying from a Trigger Input

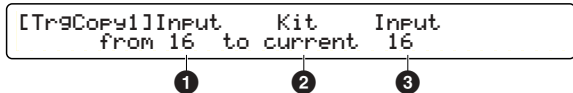

#### 1 (from) Input

Select the source trigger input.

☐ Settings: 1-16

#### 2 (to) Kit

Select the destination drum kit. Select current when copying to the current drum kit.

☐ Settings: current, U1-U40

#### 3 (to) Input

Select the destination trigger input of the drum kit 2.

☐ Settings: 1-16

### Copying from the Current Drum Kit

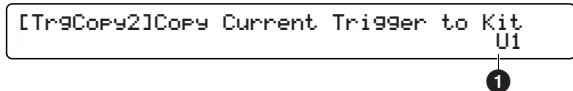

#### 1 (to) Kit

Select the destination drum kit.

☐ Settings: U1-U40

### Copy Operation

When you select the source and destination, press the ENTER/YES button. An “Are You Sure?” confirmation message will appear in the display. Press the ENTER/YES button again to actually execute the copy operation. Press the EXIT/NO button to cancel. When you return to the copy page, continue copying if desired, or resume making trigger settings.

## [MIDIEG] MIDI Envelope Generator

In this page, you can create a MIDI-controlled EG, triggered from a pad head or rim (page 39). This is a function that outputs the specified Control Change data values continuously and controls them transitionally in an envelope curve. You can use this, for example, for real-time control of the stereo panning or volume level of sustained sounds from an external synthesizer or the built-in tone generator.

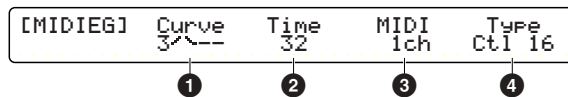

Example: Curve 3

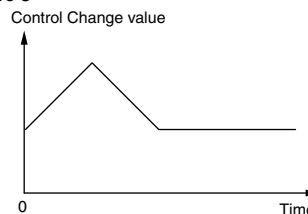

#### 1 Curve

Select from 8 different envelope curves. As shown in the diagram above, different Control Change values will be output in a transition time 2 in the envelope curve specified here.

☐ Settings: 1-8

#### 2 Time

Determines the transition time when the envelope curve 1 comes into effect. The larger the value, the longer the elapsed time.

☐ Settings: 0-127

#### 3 MIDI

Determines the MIDI channel used to output the Control Change data.

☐ Settings: 1ch-16ch

#### 4 Type

Determines the Controller number used to output the Control Change data.

☐ Settings: Ctl0-Ctl119

**NOTE** For more information on available controller numbers, refer to the Controller Number List in the separate Data List.

## [FootCtrl1] & [FootCtrl2] HH Controller Function

These two pages let you specify the function of a hi-hat controller (Yamaha HH series), connected to the HI-HAT CONTROL jack on the rear panel.

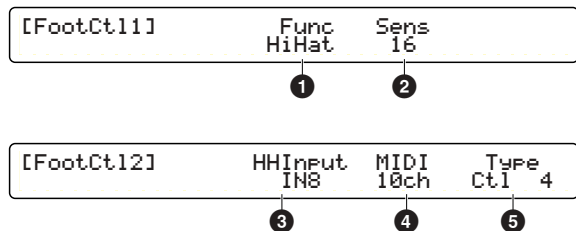

**NOTE** You may not have hi-hat sounds or lose control of them if you inadvertently change parameter values in these two pages, when using normal hi-hat settings of the hi-hat pad to the trigger input 8 (HI-HAT).

### 1 Func

Set the hi-hat controller function.

#### Settings:

- HiHatSP: Used as hi-hat controller. You can control tone changes of your drum kit by applying pressure on the pedal (default).
- HiHat: Used only as hi-hat controller.
- MIDI: Used only as MIDI continuous controller.

### 2 Sens

Adjust the sensitivity of the hi-hat controller. The larger the value, the greater the sensitivity of the controller.

Settings: 0-63

### 3 HHInput

Select the trigger input that connects the hi-hat pad. This setting internally links the hi-hat controller and the hi-hat pad when you select HiHatSP or HiHat 1 for the controller function. If you select none here, trigger inputs 1 to 16 will become identical in trigger settings (page 40) — this drum kit will not have hi-hats. In addition, you can use a foot switch for hi-hat control (page 46).

Settings: none, IN1-IN16 (default: IN8)

**NOTE** Normally, the trigger input 8 is used for hi-hats (as designated on the rear panel). This parameter lets you specify any trigger input (1 to 16) for hi-hats if you want to create a custom drum kit completely from scratch.

### 4 MIDI

Set the MIDI channel to output MIDI data 5 from the hi-hat controller. The default is channel 10 for the drum kit.

Settings: 1ch-16ch (default: 10ch)

### 5 Type

Set the type of MIDI data output from the hi-hat controller.

#### Settings:

- Ctl0-Ctl119: Controller number (default: 4)
- A/T: Aftertouch
- P/B up: Pitch Bend Up
- P/Bdwn: Pitch Bend Down

**NOTE** For more information on available controller numbers, refer to the Controller Number List in the separate Data List.

## [FootSw1] & [FootSw2] Foot Switch Function

These two pages let you specify the function of a foot switch (Yamaha FC4 or FC5) that is connected to the FOOT SW jack on the rear panel.

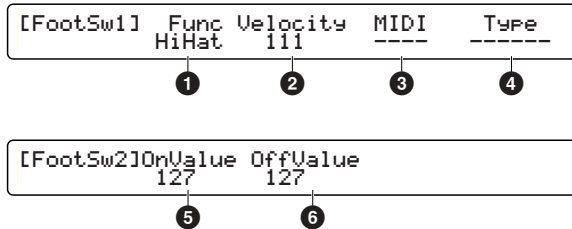

### 1 Func

Select the foot switch function.

#### Settings:

- HiHat: Acts as a hi-hat controller (switching between open and closed sounds). Make sure to set an appropriate velocity value **2** when selecting this.
- click: Enables or disables the click.
- inc: Increment — selects the next drum kit in the Play mode display, or selects the next step in the Chain Play display.
- dec: Decrement — selects the previous drum kit in the Play mode display, or selects the previous step in the Chain Play display.
- bypass: Temporarily disables trigger inputs (page 76).
- SStop: Controls playback of the main song (same as Start/Stop in the transport control).
- MIDI: Outputs Control Change data. Make sure to set the related detailed parameters **3**-**6** when selecting this.
- HH→BD: Generates a trigger signal for trigger input 9 (KICK) when the foot switch is pressed. Make sure to set an appropriate velocity value **2** when selecting this.

### 2 Velocity

Determines the velocity value output from the foot switch when HiHat or HH→BD is selected for the function **1**.

#### Settings: 1-127

### 3 MIDI

Determines the MIDI channel for the Control Change data **4** output from the foot switch when MIDI is selected for the function **1**.

#### Settings: 1ch-16ch

### 4 Type

Determines the Controller number output from the foot switch when MIDI is selected for the function **1**.

#### Settings: Ctl0-Ctl119 (controller number)

**NOTE** For more information on available controller numbers, refer to the Controller Number List in the separate Data List.

### 5 OnValue

Determines the control value output when pressing the foot switch, when MIDI is selected for the function **1**.

#### Settings: 0-127

### 6 OffValue

Determines the control value output when releasing the foot switch, when MIDI is selected for the function **1**.

#### Settings: 0-127

## [COMMON1] & [COMMON2] Kit Common Settings

These two pages let you make basic settings for the drum kit you are currently working (editing) with. For this reason, some parameters are not directly related to trigger settings.

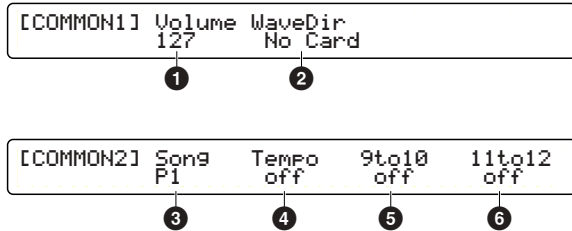

### 1 Volume

Determines the overall volume of the rhythm part including the drum kit (MIDI channel 10).

❑ **Settings:** 0-127

**NOTE** This is the same as the volume setting for MIDI channel 10 (page 54).

### 2 WaveDir

This determines the directory on the memory card (page 86), where wave samples or user voice data used together with this drum kit are stored. The next time you select this drum kit, those files will automatically be loaded. Make sure to insert the appropriate memory card into the CARD slot; otherwise, “No card” will be shown.

❑ **Settings:** Directory name on a memory card

### 3 Song

This determines the song that is automatically called up when you select this drum kit. Specify off to disable the automatic selection of a song.

❑ **Settings:** off, Preset or User song

### 4 Tempo

This determines the tempo that is automatically set when you select this drum kit. Specify off to disable the automatic tempo setting.

❑ **Settings:** off, 30-300

### 5 9to10

If you set this parameter to on, trigger signals generated at trigger input 9 (KICK) will be shared with trigger input 10. Then, set trigger input 10 to play notes in an alternate mode (for example, from a footswitch; no pad required). When you play the bass drum in this case, you can have the phrase automatically synchronized to a bass drum pattern assigned to input 9.

❑ **Settings:** off, on

### 6 11to12

If you set this parameter to on, trigger signals generated at trigger input 11 will be shared with trigger input 12. (This is used in the same way as 5 above.)

❑ **Settings:** off, on

**NOTE** Trigger inputs 9/10 and 11/12 jacks are stereo pairs. However, you can use them as four separate mono inputs if you connect four mono pads using two Y-shaped cables and setting the above two parameters 5 & 6 to off.

## [KitName] Drum Kit Name

You can enter a name of up to 8 characters for the drum kit you are now editing.

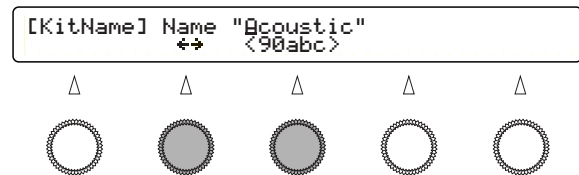

Use the second-to-left knob to move the entry position (cursor) for each character. Then, use the center knob to enter a character at that position. Repeat this step and specify the drum kit name (maximum of eight characters).

❑ **Available characters:**

	!	"	#	\$	%	&	'	(	)	*	+	,	-	.	/	0	1	2	3
4	5	6	7	8	9	:	;	<	=	>	?	@	A	B	C	D	E	F	G
H	I	J	K	L	M	N	O	P	Q	R	S	T	U	V	W	X	Y	Z	[
¥	]	^	_	`	a	b	c	d	e	f	g	h	i	j	k	l	m	n	o
p	q	r	s	t	u	v	w	x	y	z	{		}	→	←				

Once you've finished making the desired trigger settings, store this drum kit (page 35).

# Voice Settings

Press the VOICE button on the top panel, designated by DRUMKIT, to start editing voice settings for the drum kit you are currently working with.

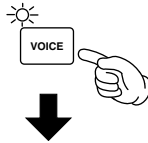

```
[Voice1] Type Voice 42* Volume Tuning
38 D1 AcSnr1 MCA55 110 - 1.00
```

**NOTE** The first page that appears (the one last called up) may be different from the display shown above (page 76).

## Edit Pages and Basic Operations

Voice settings are available in the following ten pages, categorized by purpose and function.

```
[Voice1] Type Voice 2* Volume Tuning
49C#2 XtrSnr rim 127 + 0.00
```

```
Wave1 Wave2 XFilter XDecay Balance
MaF11370 warm type1 32 0
```

```
[Voice3] Pan Layer Filter Q
49C#2 R13 +63 +63 +63
```

```
[Voice4] Attack Decay
49C#2 0 0
```

```
[Voice5] KeyMode AltGrp RvKeyOn RvKeyOff
49C#2 semi2 127 off off
```

```
[Voice6] Output RevSend ChoSend
49C#2 stereo 127 127
```

```
[VoiceCopy] Note Kit Note
from 49C#2 to current 49C#2
```

```
[MIDI1] Transmit PC# BankMSB BankLSB
Ch=10 off 001 000 000
```

```
[MIDI2] Volume Pan Ctrl# / Value
Ch=10 127 R63 127 127
```

```
[MIDI3] RevSend ChoSend
Ch=10 127 127
```

In the first six pages you can assign a drum voice for each note number contained in the rhythm and drum part (MIDI channel 10) and set up how that voice will sound. Turn the leftmost knob, and note the huge amount of target note numbers available — 82 in all (13-94). This is the total of usable notes for the rhythm and drum part, and provides more than enough to choose from in setting up a simple kit. You may also need to make adjustments to a Preset kit to suit your applications, but such settings are always minimal. In the rest of the pages, you can copy settings and make setups for other MIDI parts for playing together with a drum kit.

Settings changes

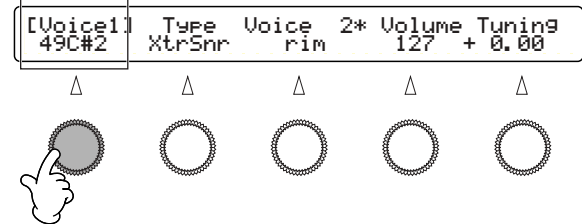

**NOTE** You can also select the target input by hitting the corresponding pad (page 76), conveniently letting you fine-tune your drum kit settings while playing.

Also, refer to Basic Operations on page 20.



## [Voice1] Voice Basics

This page lets you assign a basic drum voice and adjust its output volume and pitch. Voices are categorized by types so that you can choose them easily, while viewing the information about the voice such as whether it is two-layered, looped, and so on.

[Voice1]	Type	Voice	2*	Volume	Tuning
49C#2	XtrSnr	rim		127	+ 0.00

1                      2                      3                      4                      5

### 1 Note Number & Name

Determines the target note number (13-94: C#-1-A#5). Each note number is shown with a specific note name.

### 2 Type

Determines the voice category. You can select a voice 3 from the category specified here. Select Wave if you want to load a wave sample or audio file from a memory card. Select XtrSnr if you want an extra snare drum that can be customized in the next screen.

**Settings:** AcKick, ElKick, AcSnr1-2, EleSnr, OtrSnr, XtrSnr, AcTom1-3, EleTom, Cymbal, HiHat, Percs1-2, Efect1-3, Loop, Voice, Melody, Wave, UsrVce

**NOTE** UsrVce is a voice created using external System Exclusive parameter change data. Such voices cannot be created on the DTXTREME IIs itself, and explanations of how to use System Exclusive here are outside the scope of this manual.

### 3 Voice

Determines the voice from the specified category 2. Your selection will be shown with a number in the upper row and name in the lower row. A two-layered voice is indicated by an asterisk (\*) at the end of its number. A voice shown with a  mark at the end of its name is looped, which you can play repeatedly with a single shot (page 52). Press the Audition button while holding down the SHIFT button to stop looped playback during audition.

**Settings:** For more information on each voice, refer to the Voice List in the separate Data List.

**NOTE** If you always use a specific pad only to trigger an external sound, set NoAssign to that pad (note number) 3. However, if you normally play a voice 3 from the built-in tone generator, and sometimes replace it with an external sound, it is more convenient to temporarily mute the internal voice by disabling a specific Note On event sent to the built-in tone generator (page 80), which saves you the trouble of re-assigning NoAssign every time you need to replace a sound.

### 4 Volume

Determines the output volume of the specified voice 3. By specifically adjusting the volume for each voice, you can balance the various instruments in the drum kit.

**Settings:** 0-127

### 5 Tuning

Adjusts the pitch of the specified voice 3 by approximately one cent (1/100 semitone).

**Settings:** -24.00~+24.00

## Setting an Extra Snare Drum

Extra Snare is a special snare drum voice that you can select when you specify XtrSnr for the voice category. Moreover, you can customize the snare drum using the following parameters. (These cannot be set with other voices, and “---” is shown in the display.)

Wave1	Wave2	Xsfilter	Xsdecay	Balance
Map11370	warm	type1	32	0
1	2	3	4	5

Special snare drum is a two-layered composite voice, which is created by combining two different drum voices, adjusting the volume balance between these voices, and modifying the composite voice tone using the Filter and Decay parameters. If you use a TP120SD or TP100 pad for the snare drum, you can also use the pad controller to dynamically adjust one of the following parameters for a dynamic tone change (page 37).

### 1 Wave1

Select a drum voice for the layer 1.

- Settings: Map11370, MCAs55, MCVint55, Beech55, Maple55, Alumin55, Brass35, Brass55, Brass65, Steel65, Bamboo, FRPSnr

### 2 Wave2

Select a drum voice for the layer 2.

- Settings: warm, crisp, cool, short, punchy, BS, silky, bright, old, VOX1, VOX2, VOX3, roll, trash

### 3 Xsfilter

Specifies the filter effect.

- Settings: thru (no effect), type1, type2

### 4 Xsdecay

Adjusts the duration of your snare drum.

- Settings: off (no effect), 1-32

### 5 Balance

Adjusts the volume balance between the layer 1 and 2 sounds.

- Settings: -64-0-+63

## [Voice3] Pan & Tone

This page lets you adjust the stereo panning and filter of the voice assigned to the note number. If you selected a two-layered voice, you can also specify the volume balance between the layers.

[Voice3]	Pan	Layer	Filter	Q
49C#2	R13	+63	+63	+63
1	2	3	4	5

### 1 Note Number & Name

Determines a target note number (13-94: C#-1-A#5). Each note number is shown with a specific note name.

### 2 Pan

Determines the pan setting for the voice assigned to the note number 1. This setting determines the stereo position of the voice.

- Settings: L64-C-R63 (left to center to right)

### 3 Layer

Specify the volume balance between layers if you selected a two-layered voice for the note number 1. If the voice is not two-layered, the parameter cannot be set and “---” is shown in the display.

- Settings: -64-0-+63 (100:0-50:50-0:100)

### 4 Filter

Determines the filter setting for the voice assigned to the note number 1. This is a low-pass filter that cuts the frequencies higher than the cutoff point specified here and passes the rest, as shown in the diagram below.

- Settings: -64-+63

### 5 Q

Adjust the Q (bandwidth) factor for the filter 4. Boosting the frequencies around the cutoff point as shown in the diagram below makes the filter peak sharper and more pronounced.

- Settings: -64-+63

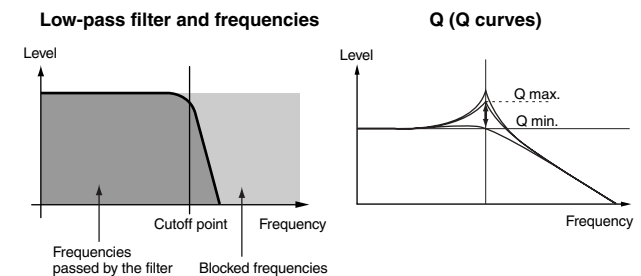

## [Voice4] Envelope

This page lets you adjust the volume envelope of the voice assigned to the note number. Every musical instrument has a unique volume envelope that helps distinguish what kind of instrument it is. For drum or percussion instruments, their unique characteristics come from the attack and decay rates (speeds) in the volume envelope. Adjusting these two factors lets you create a variety of tonal nuances in the voice.

[Voice4] Attack	Decay
49C#2	0

1                      2                      3

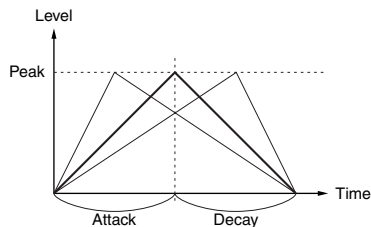

### 1 Note Number & Name

Determines a target note number (13-94: C#-1-A#5). Each note number is shown with a specific note name.

### 2 Attack

Determines the attack rate of the current voice. The larger the positive value, the faster the attack rate. The larger the negative value, the slower the attack rate. Keep in mind that if the voice originally has a fast attack rate, specifying higher values cannot make the rate faster past a certain point.

□ **Settings:** -64-+63 (slower to faster)

### 3 Decay

Determines the decay rate of the current voice. The larger the negative value, the slower the decay rate. The larger the positive value, the faster the decay rate. If you want a cymbal with a long release, set its decay rate to a large negative value. A large positive value may cause the sound to cut off unnaturally.

□ **Settings:** -64-+63 (slower to faster)

## [Voice5] Polyphony

This page lets you set how many polyphonic voices are allowed for the specified note number. The built-in tone generator can play up to 64 polyphonic notes at a time. However, there may be times when this may not be enough — particularly if you play along with many parts in a song or play the drum kit with a large number of short notes. You can prevent this by limiting the polyphony for each drum voice.

[Voice5] KeyMode	AltGrp	RvKeyOn	RvKeyOff
49C#2	semi2	125	off

1                      2                      3                      4                      5

### 1 Note Number & Name

Determines a target note number (13-94: C#-1-A#5). Each note number is shown with a specific note name.

### 2 KeyMode

Determines how the same voice is played in response to multiple notes.

#### □ Settings:

- poly: No limitation until the DTXTREME IIs tone generator reaches maximum polyphony.
- semi8: Up to eight polyphonic notes — every initial note will be muted to play the 9th note.
- semi4: Up to four polyphonic notes — every initial note will be muted to play the 5th note.
- semi3: Up to three polyphonic notes — every initial note will be muted to play the 4th note.
- semi2: Up to two polyphonic notes — every initial note will be muted to play the 3rd note.
- mono: Only a single note — each note will be muted by the subsequently played note.
- himono: Same as mono, but excluded from the last-note priority rule — notes are never muted by other notes.

**NOTE** If a note number (drum pad) is set to mono and assigned with a voice with a long release (such as cymbal), hitting that pad continuously will cut off the previous sound unnaturally. However, setting every note number to poly to prevent this situation is not a good idea, since this may “steal” polyphony from other important parts.

### 3 AltGrp

You can put multiple note numbers ❶ in a specific alternate group. By including several note numbers in the same numbered group here, prevents them from playing simultaneously. For realistic hi-hat sounds using several voices, assign HHpedal to the foot-closed voice and HHpad to other hi-hat voices triggered by the hi-hat pad and rims. This enables the foot-closed sound to mute any other hi-hat sounds when depressing the hi-hat pedal controller (HHpedal has priority over HHpad).

❑ **Settings:** off (not grouped), HHpedal, HHpad, 1-125 (group number)

📌 **NOTE** Only a single note can play at a time from one alternate group, in the last-note priority manner.

### 4 RvKeyOn

Determines whether the built-in tone generator receives Note On events for the note number ❶. This is useful when you want to output them from MIDI OUT on the rear panel, without routing to the built-in tone generator, for the purpose of triggering only external sounds. Set this to on if you want to play voices from the built-in tone generator.

❑ **Settings:** off, on

### 5 RvKeyOff

Determines whether the built-in tone generator receives Note Off events for the note number ❶. Set this to off if you want to ensure that a cymbal voice or a one-shot wave sample plays to its full duration.

❑ **Settings:** off, on

## Using Note Off with Looped Voices

Most drum voices are one-shot samples and automatically stop playing at the end of the wave data without receiving a Note Off event (RvKeyOff = off). If you set these voices to receive Note Off events (RvKeyOff = on), adjust the gate time (page 42) properly to match their release time, otherwise playback of the sound will be cut off in the middle. On the other hand, the built-in tone generator also features looped voices, and these need to be set for receiving Note Off events (RvKeyOff = on), otherwise they will not stop playback. Because of this, Note Off is crucial to effectively using looped voices. To properly use a looped voice, set its note number to generate Note Off events (RvKeyOff = on) in conjunction with the gate time setting. For example, you can hit the pad every second measure to play a looped voice endlessly if the gate time is adjusted to match two measures in the performance tempo. You may also need to limit its polyphony to a single note (KeyMode = mono).

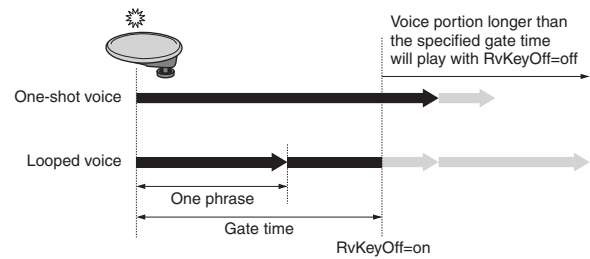

## [Voice6] Output Routing

This page lets you set an output routing for the voice assigned to the note number. Though your basic options are one of the INDIVIDUAL OUTPUT (1 to 6) jacks for parallel output or a pair of OUTPUT jacks for stereo output, you can use them for more variations in conjunction with effect settings (page 55).

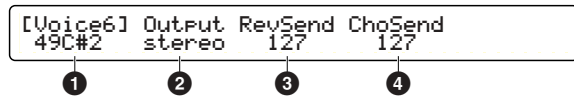

### 1 Note Number & Name

Determines a target note number (13-94: C#-1~A#5). Each note number is shown with a specific note name.

### 2 Output

Determines the output for the voice assigned to the note number 1. When routed to an Individual Output, the voice cannot be monitored using headphones.

#### Settings:

- stereo: Routed to OUTPUT (L/MONO and R).
- InsFx1, InsFx2: Routed to the specified insertion effect (1 or 2). You cannot select these when the Localizer is enabled.
- thru: Routed to OUTPUT (L/MONO and R) bypassing the Localizer. You can select this only when the Localizer is enabled.
- IND1&2, 3&4, 5&6: Routed to the specified pair of Individual Outputs (in stereo).
- IND1, 2, ... 6: Routed to the specified Individual Output (in mono).

**NOTE** If you select either insertion effect (InsFX1 or InsFX2), the final output is determined by the insertion effect settings.

### 3 RevSend

Determines the send level to the reverb effect (system effect) for the voice assigned to the note number 1.

Settings: 0-127

### 4 ChoSend

Determines the send level to the chorus effect (system effect) for the voice assigned to the note number 1.

Settings: 0-127

**NOTE** Actual amounts of the reverb and chorus effects for each drum voice are determined by the master send levels for the entire drum kit (page 58).

## [VoiceCopy] Voice Copy

You can copy voice settings for a specific note number (MIDI channel 10) to the drum kit you are editing, letting you set up an editing template for creating drum kits with similar settings.

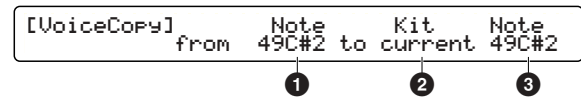

### 1 (from) Note

Determines the source note name (of the current drum kit).

Settings: 13C#-1-94A#5

### 2 (to) Kit

Determines the destination drum kit. Select current when copying to the current drum kit.

Settings: current, U1-U40

### 3 (to) Note

Determines the destination note name of the drum kit 2.

Settings: 13C#-1-94A#5

## Copy Operation

After selecting the source and destination, press the ENTER/YES button. An "Are You Sure?" confirmation message appears in the display. Press the ENTER/YES button again to actually execute the copy operation. Press the EXIT/NO button to cancel. When you return to the copy page, continue copying if desired, or resume making voice settings.

## [MIDI1], [MIDI2] & [MIDI3] MIDI Setup

Use these three pages to make settings for a MIDI ensemble using the built-in tone generator or external sound modules. The setting data will be sent to MIDI parts internally or externally (via MIDI OUT or USB) when you recall and play the drum kit you are currently editing.

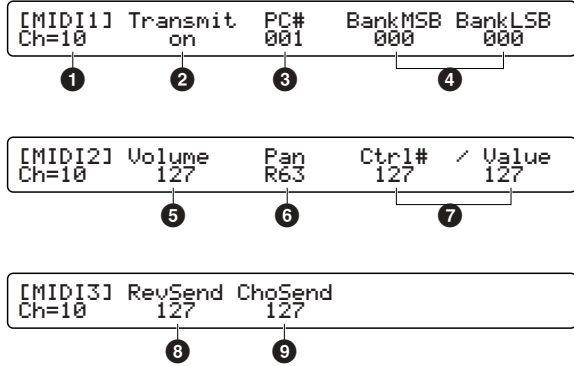

### 1 Ch=

Determines the target MIDI channel (1 to 16).

### 2 Transmit

Determines the MIDI events that will be sent out over the target channel **1**.

#### Settings:

- off: Sends no MIDI events. All following parameters cannot be set and “---” is shown in the display.
- all: Sends both Program Change and Control Change, and all following parameters become accessible.
- PC: Sends only Program Change, and parameters related to Program Change become accessible. Parameters related to Control Change (in the 2nd and 3rd screens) are disabled.

**NOTE** When sending and setting only Program Change (Transmit=PC), you can also use Bank Select (a Control Change event).

### 3 PC#

Determines the program number to be transmitted. If used for the built-in tone generator, this specifies a GM voice.

Settings: 001-128

**NOTE** If you set a program number for channel 10 (Ch = 10), it will be only sent out externally via MIDI OUT or USB. Since it is not sent to the built-in tone generator, your drum kit will not be affected.

### 4 BankMSB & BankLSB

If you use an external sound module that has multiple sound banks, you can use these two events for selecting a bank. In combination with the program number parameter **3**, you can select a specific sound program. However, you do not need to use these two events for the built-in tone generator since it has no banks.

Settings: 000-127 (for both MSB and LSB)

### 5 Volume

Determines the value for the controller number 007 (volume). If used for the built-in tone generator, this affects the volume of each part.

Settings: 000-127

### 6 Pan

Determines the value for the controller number 010 (pan). If used for the built-in tone generator, this affects the stereo panning of each part.

Settings: 000-064-127 (left to center to right)

### 7 Ctrl# & Value

Control Change is MIDI information used to control the performance of a MIDI device. You can control a variety of functions pre-defined as controller numbers and their control values. These two parameters let you create a specific Control Change event by setting the controller number (Ctrl#) and control value (Value).

Settings: ---, 000-127 (Ctrl#), 000-127 (Value)

**NOTE** Selecting “---” for Ctrl# will automatically set “---” for Value, disabling this feature.

### 8 RevSend

Determines the value for the controller number 091 (effect depth). If used for the built-in tone generator, this specifies the master send level to the reverb effect (system effect) for each part.

Settings: 000-127

### 9 ChoSend

Determines the value for the controller number 093 (effect depth). If used for the built-in tone generator, this specifies the master send level to the chorus effect (system effect) for each part.

Settings: 000-127

**NOTE** If you set a Control Change event **7** that duplicates the Volume **5**, Pan **6**, RevSend **8**, or ChoSend **9** setting, the Control Change event **7** will take priority.

Once you've finished making the desired voice settings, store this drum kit (page 35).

# Effect Settings

DTXTREME IIs provides reverb and chorus as system effects, as well as two different insertion effects, and a three-dimensional Localizer effect.

## Reverb

This system effect includes 12 reverb types that let you recreate the ambience of a performance space — from a small room to a large concert hall. In the voice settings (page 53), you can specify the amount of reverb applied to each drum voice in the drum kit. This is useful, for example, if you want more reverb for the snare drum, but less for the bass drum.

## Chorus

This system effect includes 13 chorus types of soft to hard modulations (chorus, flanger, jet effect, and so on). In the voice settings (page 53), you can specify the amount of chorus applied to each drum voice in the drum kit. This is useful, for example, if you want unique flanging sounds for hi-hats and other cymbals.

## Insertion Effects 1 and 2

These additional effects give you tools to further enhance the sound — or even completely change the sonic character of a voice. Each effect block has a wide variety of 44 types (chorus, flanger, distortion, wah, etc.). These two insertion effects are arranged in parallel so that you can selectively apply the effects to specific drum voices in your drum kit.

## Localizer

This effect is optimized for headphone monitoring and creates a realistic 3D sound image of your drum kit — placing each instrument in a specific “virtual” space in the 3D ambience, so that each sound appears to come from a different direction. This 3D effect can be specified separately for your drum kit and other instruments in the song, and gives you the feeling of playing drums in a realistic ensemble. This 3D effect is intended for headphones and cannot be heard well if played from normal speakers.

**NOTE** Both insertion effects and the system chorus effect are automatically disabled when the Localizer effect is active.

## Sound Mixing that Fully Utilizes Effects

Slider controls on the top panel let you easily mix the instrument sounds of the DTXTREME IIs. However, you can also create more complex and more flexible mixing schemes in conjunction with the output routing for each drum voice (page 53) and effect settings explained here. First, take a look at the following diagram. It shows possible output routings for each drum voice with several parameter settings.

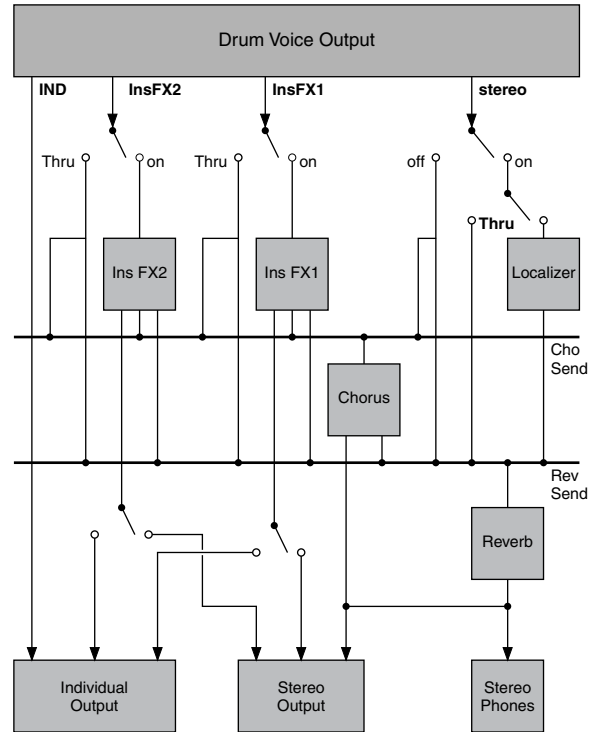

The actual effect settings include the output routing after drum voices are applied with an effect, and this is closely associated with the output setting of each drum voice. In other words, specifying the output of a drum voice also determines which effect can be applied to that voice. In the left part of the diagram, you can see four basic output options — stereo, InsFX1, InsFX2, IND — provided for each drum voice. Also, thru is added to the options when you enable the Localizer.

(Continued to next page)

(Continued from previous page)

## 4 Completely Separate Effects

If you specifically set the output of each drum voice, system effects and two insertion effects can be used as four completely separate effects. Here is an example of applying four different effects to four separate drum voices and sending the signals to the stereo OUTPUT jacks:

### Settings in the [Voice6] page...

- For drum voice 1: Output = stereo, RevSend = (other than zero), ChoSend = 0
- For drum voice 2: Output = stereo, RevSend = 0, ChoSend = (other than zero)
- For drum voice 3: Output = InsFX1
- For drum voice 4: Output = InsFX2

### Effect settings:

- In the [Effect] page (master send levels to system reverb and chorus effects): Localizer = off, RevSend = (other than zero), ChoSend = (other than zero)
- In the [Reverb] page (master return level from system reverb effect): RevRetrn = (other than zero)
- In the [Chorus] page (master return level from system chorus effect): Cho→Rev = 0, ChoRetrn = (other than zero)
- In the [InsFX] pages: Type = (other than THRU) for FX = 1, and RevSend = 0 (zero), ChoSend = 0, Output = stereo
- In the [InsFX] pages: Type = (other than THRU) for FX = 2, and RevSend = 0, ChoSend = 0, Output = stereo

If you make four one-on-one routes (from voice to effect) and select a different effect (also different from system reverb and chorus effects) for each insertion effect, you can output each drum voice in stereo, each with a different effect applied.

## Parallel Outputs with Effects

You can easily send a drum voice to the INDIVIDUAL OUTPUT jacks if you set Output to IND (in stereo pair or mono) in the voice settings. However, these settings only allow dry outputs of drum voices without any effects applied. You can also utilize insertion effects for parallel outputs of drum voices while applying your favorite effects.

### Settings in the [Voice6] page...

- Output = InsFX1 — for snare drum
- Output = InsFX2 — for bass drum
- Output = IND3&4 — for tom 1
- Output = IND3&4 — for tom 2
- Output = IND5&6 — for tom 3
- Output = IND5&6 — for tom 4
- Output = stereo, RevSend = (any value), ChoSend = (any value) — for cymbals

### Effect settings:

- In the [Effect] page (master send levels to system reverb and chorus effects): Localizer = off, RevSend = (other than zero), ChoSend = (other than zero)
- In the [Reverb] page (master return level from system reverb effect): RevRetrn = (other than zero)
- In the [Chorus] page (master return level from system chorus effect): Cho→Rev = (any value), ChoRetrn = (other than zero)
- In the [InsFX] pages: Type = 2BandEQ for FX = 1, and RevSend = 0, ChoSend = 0, Output = IND1
- In the [InsFX] pages: Type = COMP for FX = 2, and RevSend = 0, ChoSend = 0, Output = IND2

With these settings, you can obtain the following results. Note that you can even count and use the stereo OUTPUT jacks as a pair of INDIVIDUAL OUTPUT jacks.

- Snare drum: Mono output from INDIVIDUAL OUTPUT 1 without system reverb and chorus effects, after processing with two-band equalizer from insertion effect 1.
- Bass drum: Mono output from INDIVIDUAL OUTPUT 2, after processing with compressor from insertion effect 2.
- Toms 1 and 2: Stereo output from INDIVIDUAL OUTPUT 3 and 4 without any effects applied.
- Toms 3 and 4: Stereo output from INDIVIDUAL OUTPUT 5 and 6 without any effects applied.
- Cymbals: Stereo output from OUTPUT (L/MONO and R) with system reverb and chorus effects applied.

In these examples, the output signal routing and effect settings are closely associated. Try out other signal routings for your specific applications and requirements.



## [Effect] Effect Basics

Press the EFFECT button on the top panel, designated by DRUMKIT, to start editing effect settings for the drum kit you are currently working with.

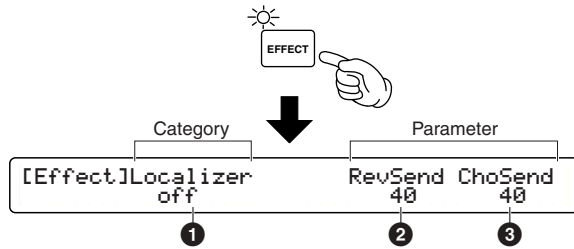

**NOTE** The first page that appears (the one last called up) may be different from the display shown above (page 76).

### 1 Localizer

Enable (on) or disable (off) the Localizer.

**Settings:** on, off

**NOTE** When the Localizer is enabled, you can use only the system reverb effect for other effects. Since you cannot use system chorus and insertion effects, their respective edit pages will not appear. If the Localizer is disabled, its edit pages will not appear instead.

### 2 RevSend

Determines the send level to the system reverb effect for the entire drum kit. This works as a master level to reverb send levels for the drum voices (page 53).

**Settings:** 0-127

### 3 ChoSend

Determines the send level to the system chorus effect for the entire drum kit. This works as a master level to chorus send levels for the drum voices (page 53).

**Settings:** --- (disabled when the Localizer is enabled), 0-127

**NOTE** RevSend **2** and ChoSend **3** only work for rhythm part (MIDI channel 10) from the built-in tone generator. These are equivalent to the reverb send and chorus send levels (page 54) available when transmission to MIDI channel 10 is enabled.

## [Reverb] System Reverb Effect

Configure the system reverb effect. This setting data will be sent to the built-in tone generator when you recall and play the drum kit you are currently editing. This setting data is shared not only with each drum voice (MIDI channel 10), but also with all other parts from the built-in tone generator.

[Reverb]	Type	Time	Diffusion	InitDelay
	HALL1	2.1	10	12.7

1

### 1 Type

Select a reverb type. For system reverb, you can choose from the following 12 types. Select NONE if you want to temporarily disable the system reverb.

**Settings:** NONE, HALL1-2, ROOM1-3, STAGE1-2, PLATE, WHITEROOM, TUNNEL, CANYON, BASEMENT

For detailed explanations of the other parameters, refer to the Effect Type List in the separate Data List. Note that the same parameter name may not always represent an identical function.

**NOTE** System reverb effect offers a single reverb effect specified here to all parts from the built-in tone generator. Use an insertion effect if you want to apply a different reverb effect to a drum voice.

## [Chorus] System Chorus Effect

Configure the system chorus effect. This setting data will be sent to the built-in tone generator when you recall and play the drum kit you are currently editing. This setting data is shared not only with each drum voice (MIDI channel 10), but also with all other parts from the built-in tone generator.

[Chorus]	Type	LFO	Depth	FBLevel
	CHORUS1	0.25Hz	54	+13

1

**NOTE** You cannot configure the system chorus effect when the Localizer is enabled (page 57).

### 1 Type

Select a chorus type. For system chorus, you can choose from the following 14 types. Select NONE if you want to temporarily disable the system chorus.

**Settings:** NONE, CHORUS1-4, CELESTE1-4, FLANGER1-3, SYMPHONIC, ENSEMBLE, PHASER

For detailed explanation for any other parameters, refer to the Effect Type List in the separate Data List. Note that the same parameter name may not always suggest an identical function.

**NOTE** System chorus effect offers a single chorus effect specified here to all parts from the built-in tone generator. Use an insertion effect if you want to apply a different chorus effect to a drum voice.

## [InsFX] Insertion Effects

Configure each of 2 insertion effects. Besides the system effects, you can use these to apply a variety of effects to drum voices, or to make an advanced internal mix by DTXEXTREME II itself.

[InsFX]	Type	Dry/Wet	L→RDelay	R→LDelay
FX=1	CrossDelay	(D=W)	170.0	170.0

1

2

**NOTE** You cannot configure the system chorus effect when the Localizer is enabled (page 57).

### 1 FX=

Select the target insertion effect (1 or 2) using the leftmost knob.

**Settings:** 1, 2

### 2 Type

Select an effect type to assign. You can assign any of 44 types for each insertion effect.

**Settings:** THRU, HALL1-2, ROOM1-3, STAGE1-2, PLATE, DelayLCR, DelayLR, ECHO, CrossDelay, KARAOKE1-3, CHORUS1-4, CELESTE1-4, FLANGER1-3, SYMPHONIC, ENSEMBLE, ROTARY, TREMOLO, AUTOPAN, PHASER, DISTORTION, OVERDRIVE, AMPSIM, 3BandEQ, 2BandEQ, FILTER, AUTOWAH, TOUCHWAH1-2, ENHANCER, COMP, NOISEGATE

For detailed explanations of the other parameters, refer to the Effect Type List in the separate Data List. Note that the same parameter name may not always represent an identical function.

## [Loclizr] Localizer

Configure the 3D effects from the Localizer. These effects are only effective when monitored through stereo headphones. When monitored through speakers, instruments to which the Localizer effect is applied may sound strange.

[Loclizr]	Type	DrSens	AcSens	HRTF
	NORMAL	16	16	15

1

2

3

4

[Loclizr]	Rotation	Dist	Angle
	120	10.0	30

5

6

7

## 1 Type

Determines the stereophonic effect from 5 preset types. The following diagrams show how each stereophonic effect (virtual stereo speakers) is monitored using the headphones.

□ **Settings:** THRU, NORMAL, NEAR, FAR, WIDE, POINT

### NORMAL

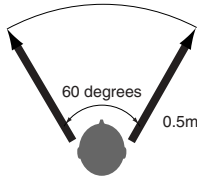

Left and right speakers positioned 0.5 meter ahead of the listener, at the angle of 60 degrees.

### NEAR

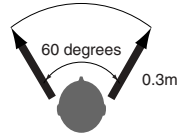

Left and right speakers positioned 0.3 meter ahead of the listener, at the angle of 60 degrees.

### FAR

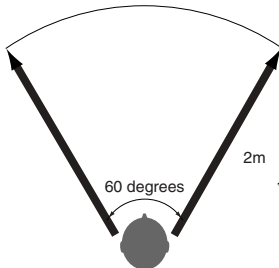

Left and right speakers positioned 2 meters ahead of the listener, at the angle of 60 degrees.

### WIDE

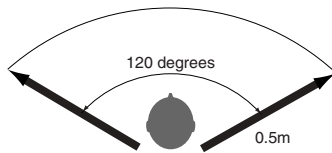

Left and right speakers positioned 0.5 meter ahead of the listener, at the angle of 120 degrees.

### POINT

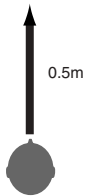

A speaker positioned 0.5 meter ahead of the listener.

## 2 DrSens

Determines the stereophonic position of the drum kit. The larger the value, the greater the degree of the 3D positioning. The smaller the value, the more the normal stereo panning is emphasized, as specified for each drum voice in the voice settings (page 50). For a value of zero, the Localizer is bypassed and no 3D effect is applied.

□ **Settings:** 0-16

## 3 AcpSens

Determines the stereophonic position of the accompaniment instruments (other than the drum kit). The larger the value, the greater the degree of the 3D positioning. The smaller the value, the more the normal stereo panning is emphasized, as specified for each part in the voice settings (page 54). For a value of zero, the Localizer is bypassed and no 3D effect is applied.

□ **Settings:** 0-16

## 4 HRTF (Head Related Transfer Function)

Perception of the sound image is different from person to person. An audible effect that one person cannot perceive may give an extreme effect (sound modulation) to another. This parameter can compensate for such personal differences in perception.

□ **Settings:** 0-20

## 5 Rotation

Determines the position (angle) of all instruments available on the DTXTREME IIs. This is a virtual position perceived when monitored with headphones. As a larger positive value is set, all instruments including the drum kit will accordingly rotate clockwise from the listener's front (center) to back (0 to 180 degrees). As a larger negative value is set, all instruments including the drum kit will accordingly rotate counterclockwise from the listener's front (center) to back (0 to 180 degrees).

□ **Settings:** -180-0-180 (back to front to back, unit: degree)

## 6 Dist

Determines the distance of all instruments available on DTXTREME IIs. This is a virtual distance perceived when monitored with headphones. The larger the value, the greater the virtual distance of all instruments, including the drum kit.

□ **Settings:** 0.3-10.0 (meter)

## 7 Angle

Determines the amount of stereo width (left to right) of the sounds of the DTXTREME IIs. With the center at zero, the sounds will expand to a maximum width of 180 degrees.

□ **Settings:** 0-180 (center to left and right, unit: degree)

Once you've finished making the desired effect settings, store this drum kit (page 35).

# Song Recording and Editing

As you may have already found out by listening to the Preset songs, the DTXTREME IIs has a built-in MIDI sequencer. This sequencer lets you not only play the drum kit along with playback of Preset songs, but also easily record your performance on the drum kit or MIDI keyboard as a User song (U1-U32). You can play a User song as main song or pad song (page 25).

## Features of the Two-track Sequencer

Before you start your recording session, take a look below at some of the things you can do with the built-in sequencer.

### • Three Recording Modes

You can record a song in any of 3 recording modes — Replace, OverDub, Step (page 61). In Replace and OverDub modes, you can record your performance in real time. Within a specified number of measures, Replace mode offers one-way recording and OverDub mode offers repeated recording. With the Step mode, you can record MIDI events manually, one-by-one into the timeline (data entry area). You can also use Step mode for editing MIDI events you've recorded in Replace or OverDub mode.

### • 2-Track Structure

The built-in sequencer offers 2 sequence tracks (Tr1 and Tr2) to each song, and you can use them for both recording and playback. Each track can contain any event on any MIDI channel (1 to 16). This means you can connect a keyboard to the DTXTREME IIs MIDI IN and (with the help of a keyboard playing friend) record both the keyboard performance and your drum kit playing in real time onto separate tracks. If you are a multi-instrumentalist, you can conveniently use OverDub mode to record several different parts, one at a time. Even after recording a part in Replace mode, you can switch to OverDub mode to record other parts onto the same track. Since you can merge contents on both tracks into one and free up a track (page 68), you can use one track only for a specific part to separately be recorded. The built-in sequencer is very simple to use, yet gives you a full set of comprehensive, flexible tools to manage your recordings.

### • MIDI I/O to External Device

With real-time recording, you can use the built-in sequencer to capture a MIDI sequence played on an external sequencer or a personal computer. For this application, connect the DTXTREME IIs to the appropriate device to transfer MIDI data (page 18). You can also set the built-in sequencer to work in sync with an external MIDI device or to be controlled from that device.

### • Using Preset songs

Preset songs are provided for playback only. However, you can copy a favorite song to a User song in the DTXTREME IIs memory — then mute the original drum track and play it yourself, or add your own phrases with an external MIDI keyboard in OverDub mode.

## Preparation for Recording

Before you start recording a song, set up the DTXTREME IIs as described below.

**NOTE** You can start recording a song even while editing a drum kit or using other function modes. When you finish or cancel recording, you can resume working from the previous display.

1. Select the desired User song (U1-U32) for recording in the default Play mode display (page 23). If you select a new song, its default name (EmptySng) will appear as the song name. Set the desired tempo, beat, and click. You can change the tempo later when playing the recorded song.

KIT=P1	SONG=P1	TEMPO	BEAT	CLICK
Kit name	Songname	♩=120	4/4	↓

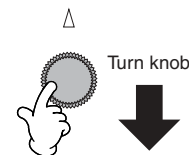

KIT=P1	SONG=U1	TEMPO	BEAT	CLICK
Kit name	EmptySng	♩=120	4/4	↓

**NOTE** The beat (time signature) cannot be changed after recording. Also, the tempo need not be set when recording in Step mode.

- 2.** Set any of the following as desired, using the utility features.
- **Two-measure count before actual recording (page 82):** By default, you can lead into the recording with a two-measure click count.
  - **Click count during recording (page 81):** By default, you can have the click count play throughout recording at the tempo and beat specified in step 1.
  - **Sync settings to external devices (page 82):** You can control the built-in sequencer from an external sequencer, and sync to that device's tempo.
- 3.** Press the Record button. The indicator will light up in red, indicating that the built-in sequencer is set to recording standby. If you want to cancel recording, press the Record button again or press the EXIT/NO button (to return to the default display).

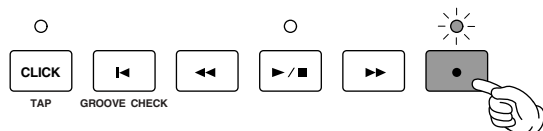

**NOTE** When you skip step 1 and instantly press the Record button, the first empty song is automatically selected and named “no name” (shown in the display). If there is no empty song, you cannot select a User song by pressing the Record button.

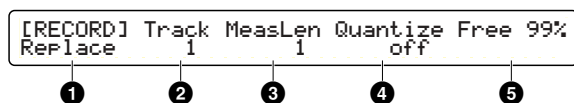

In this screen, you can select items such as recording mode, target track, etc. Once you finish specifying these, you can start recording (page 62).

## 1 Recording mode

Determines the recording mode.

□ **Settings:**

- **Replace:** Real-time one-way recording. Recording stops when the specified number of measures is over or when you press the Start/Stop button.
- **OverDub:** Real-time repeated recording. Recording repeats within the specified number of measures until you press the Start/Stop button.
- **Step:** Step recording. Enter the desired MIDI data into the timeline display, according to the specified note resolution **4**.

## 2 Track

Determines the target track for recording.

□ **Settings:** 1, 2

## 3 MeasLen

Determines the number of measures for real-time recording. Specify this when recording in Replace or OverDub mode.

□ **Settings:** 1-999

**NOTE** If there is recorded data in the song, the measure length is already determined and cannot be exceeded. You can extend the song length before recording (page 70) if necessary, which is also helpful for editing in Step mode.

## 4 Quantize

Determines the shortest note length to be recorded. The off setting is only available for real-time recording. Refer to the column below for information on quantizing.

□ **Settings:** off, quarter note, quarter note triplet, 8th note, 8th note triplet, 16th note, 16th note triplet

## 5 Free Memory

Shows the amount of available free memory. This gives you an idea of how much more data you can record.

## Resolution and Quantize

If you set Quantize ④ to some value other than off (determining the shortest note for real-time recording), your performance will be auto-corrected while recording according to the selected timing (resolution). If you set it to off, your performance will be recorded exactly as you perform it (actually at the resolution of 1/96 quarter notes).

Original Data



Quantization



**NOTE** Setting the shortest note for added recording in OverDub mode may also correct the timing of existing data, if it is larger than the newly specified one. You can correct the overall timing of the recorded data after recording (page 67).

You can conveniently use the Quantize setting in step recording. If you record (enter) an 8th-note phrase with grace notes, you can first record only the main phrase in the 8th-note resolution. Then, set an appropriate resolution for the grace notes to ensure their entries in correct positions.

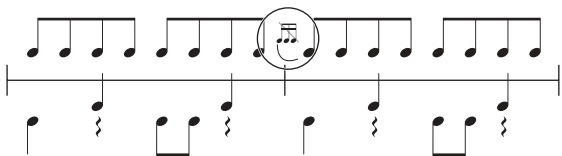

# Recording Operations

Now you can start recording according to the recording mode specified (page 60).

## Real-time Recording

1. Press the Start/Stop button. Actual recording will begin after a two-measure click count if it is enabled (page 82). Your performance is recorded as MIDI data whenever you hit pads or play a connected MIDI keyboard.

Song number	Song name	Show current measure number/beat
SONG=U1	no name	M001-04 J=100 4/4
	Now Recording ...	

Tempo      Time signature

**NOTE** When recording in OverDub mode, you can delete all Note On data associated to the pad by simultaneously holding down the BASS/DELETE button and hitting the pad. Similarly, you can delete Note On data from the MIDI keyboard by simultaneously holding down the BASS/DELETE button and pressing the corresponding keys, one at a time.

2. Press the Start/Stop button again to end recording. You can edit the recorded data using the song job features (page 65) or switch to Step mode to manually correct or edit the data.

**NOTE** If you switch the power off during recording, you may lose all your User song data.

## Step Recording

1. Press the Start/Stop button to call up the timeline display. The following blank timeline appears if no MIDI data has been recorded previously.

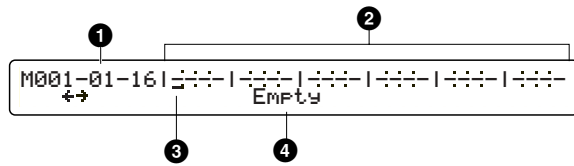

**NOTE** A dot (•) in the display indicates that MIDI data already exists at the location.

### 1 Measure/Beat/Clock

Shows the current entry (cursor) position.

### 2 Data Area

Each measure is separated by a vertical line, where entered data is represented by a dot. The displayed resolution will vary according to the specified Quantize setting.

### 3 Cursor

You can enter a MIDI event at the cursor position. You can also edit or delete an existing event by moving the cursor to a dot position.

### 4 Empty

This will be shown indicating there is no data at the current position, instead of each MIDI event.

2. Move the cursor to a position where you want to enter a MIDI event or where there is a MIDI event you want to edit. You can move the cursor in any of the following manners:

- Leftmost knob: Moves the cursor in the specified resolution (shortest note length).
- Forward button: Moves the cursor to the beginning of the next measure.
- Rewind button: Moves the cursor to the beginning of the previous measure.
- Reset button: Moves the cursor to the beginning of the timeline (song).

**NOTE** If you move the cursor to a position where multiple MIDI events exist, turning the knob will alternately show each event. In this case, the cursor does not move to the next position until the last event at the current position has been reached.

3. Enter, add, change, or delete MIDI events as necessary (see below).

4. Press the Start/Stop button again to end recording.

## Entering or Adding a MIDI Event

Press the RHYTHM/INSERT button. One of the MIDI event options will flash at the current cursor position. Enter the desired event, referring to the section Available MIDI Events in Step Recording below.

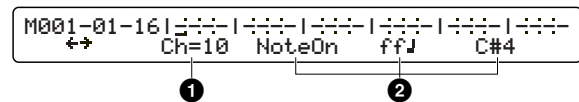

**NOTE** Use a song job feature (page 70) if you want to set a new beat (time signature).

Specify a MIDI channel (1 to 16) **1**, event type, and other parameters **2** for the MIDI event being entered, using the corresponding knob. When you press the ENTER/YES button to determine the event, it will be added to the current cursor position and displayed as a dot (•) in the timeline.

## Changing or Deleting a MIDI Event

### To change parameter values for an existing event:

Move the cursor to display the target event. Change the value using the corresponding knob. When the value flashes in the display, press the ENTER/YES button to actually enter it (the value stays lit).

### To delete an existing event:

Move the cursor to display the target event. Press the BASS/DELETE button to delete it.

**NOTE** You cannot change the event type of existing data to another type. Instead, just delete it, and enter the desired event as a new one.

## Available MIDI Events in Step Recording

You can record the following MIDI events in step recording.

### Note On

Specify a Note On event with note number and a combination of velocity and note length.

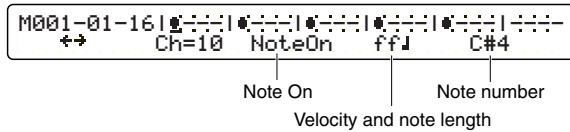

**Velocity and note length:** Select from 72 available combinations

**Settings:**

- Six velocity values: pp (pianissimo), p (piano), mp (mezzo piano), mf (mezzo forte), f (forte), ff (fortissimo)
- Twelve note length values: full note, half note, dotted quarter note, quarter note, quarter note triplet, dotted 8th note, 8th note, 8th note triplet, dotted 16th note, 16th note, 16th note triplet, 32nd note

**Note number:** Middle C (C3) on a standard piano corresponds to note number 60 (page 42).

**Settings:** C-2-C3-G8 (0-60-127)

### Program Change

Set this if you want to switch to another sound (voice) program in the middle of the song.

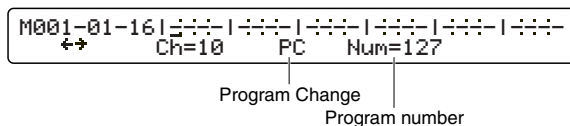

**NOTE** You can also enter a Program Change event as stored data for each part, at the beginning of a song (page 72).

**Program number:** Set the program number.

**Settings:** 1-128

### Control Change

Control Change numbers are powerful tools that give you expressive control over the sound. You can select a different function from pre-defined controller numbers and set the amount of control with a value from 0 to 127.

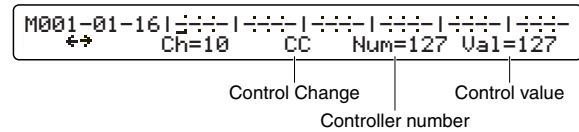

**Controller number:** Set the controller number.

**Settings:** 0-127

**Control value:** Set the selected controller's value.

**Settings:** 0-127

**NOTE** By setting the two Bank Select Control Change events (page 72) before a Program Change event, you can select a sound program from a specific bank of an external tone generator.

### Pitch Bend

Set this to control the pitch of a sound. This information is identical to that generated when you move the pitch bend wheel on a synthesizer or so on.

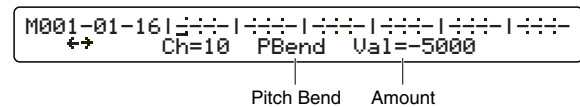

**Amount:** Set the amount of pitch change (how much the pitch bend wheel is moved).

**Settings:** -8192-0-8191 (zero: normal pitch)

### Channel Aftertouch

This is another expressive performance control. This information is identical to that generated when you apply pressure to a key before releasing it, and can be set to change the tonal qualities of the sound.

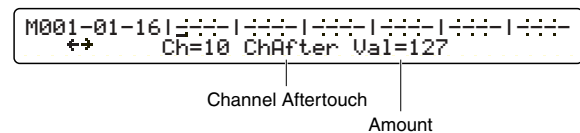

**Amount:** Set the amount of channel aftertouch.

**Settings:** 0-127



## Tempo Change

Set this if you want to change the tempo in the middle of the song.

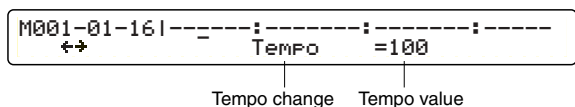

**NOTE** You can set the initial tempo as song setting data at the beginning of a song (page 67).

**Tempo value:** Set the desired tempo, as a value of beats (quarter notes) per minute.

☐ **Settings:** 30-300 bpm

## Polyphonic Key Pressure

This is another expressive performance control. This information is identical to that generated when you apply pressure to a key before releasing it. However, unlike with Channel Aftertouch explained earlier, the pressure on each key can generate a different value.

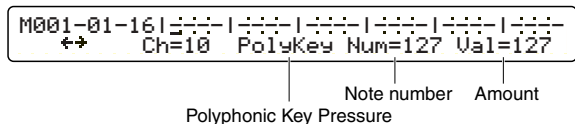

**Note number:** Set the note number that generates a Polyphonic Key Pressure event.

☐ **Settings:** 0-127

**Amount:** Set the amount of pressure generated by the specified note number.

☐ **Settings:** 0-127

**NOTE** The built-in tone generator does not recognize or respond to Polyphonic Key pressure or Channel Aftertouch events (no effect). When using such events with an external tone generator, make sure the device responds to the events.

## Pad Song Event

Program this event in the song, so that the song can “hit the pad” and initiate playback of a pad song. Then, triggered Pad song will play out based on its settings for the corresponding trigger input (page 40).

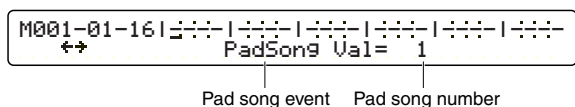

**Pad song number:** Specify a pad song with the corresponding number (see note).

☐ **Settings:** 1-4

**NOTE** Pad song numbers respectively correspond to four trigger inputs in ascending order. If you assign a song to each of trigger inputs 11, 12, 15 and 16, Pad song number “3” will specify the song assigned to the trigger input 15.

## Song Job Features

Press the SONG JOB button on the top panel to start editing the currently selected User song (U1 to U32).

**NOTE** Preset songs or User songs on memory card cannot be edited, so pressing the SONG JOB button for a memory card has no effect.

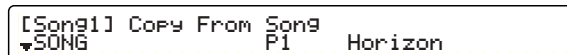

**NOTE** The first page that appears (the one last called up) may be different from the display shown above (page 76).

## Edit Pages and Basic Operations

Song job features are available in the following fourteen pages, divided into general editing categories — SONG, TRACK, MEASURE, and VOICE.

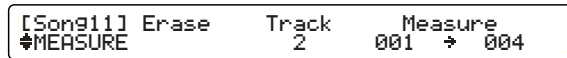
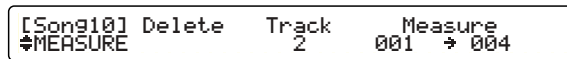
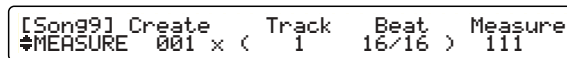
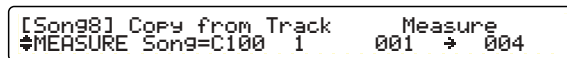
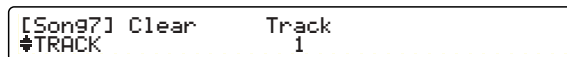
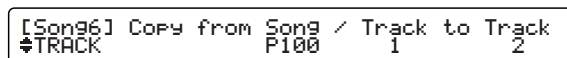
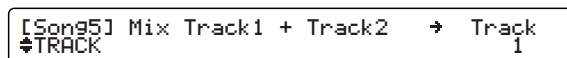
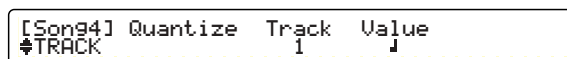
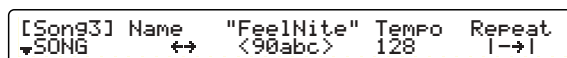
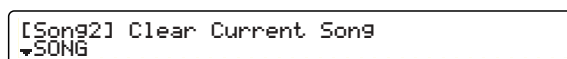
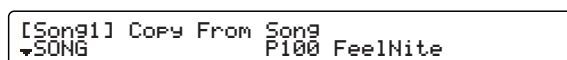

[Song12]	Ch	Transmit	Volume	Pan
▲VOICE	16	on	100	064

[Song13]	Ch	PC#	BankMSB	BankLSB
▲VOICE	16	001	000	000

[Song14]	Ch	Filter	RevSend	ChoSend
▲VOICE	16	127	127	127

Use the leftmost knob to jump to the first page of each category, then immediately open the desired page by scrolling up or down with the Page buttons.

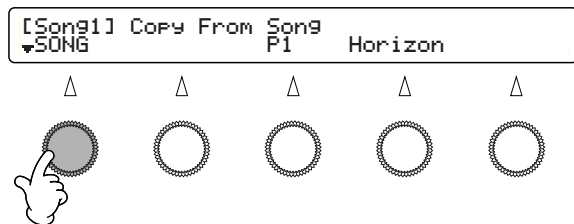

Also, refer to Basic Operations on page 20.

## [Song1] Song Copy

This lets you copy a Preset or User song to the current User song.

[Song1]	Copy From Song	
▼SONG	P1	Horizon

①

### ① Copy From Song

Select the source song using the center knob (song name also appears).

**Settings:** Preset or User song (songs cannot be copied from the memory card)

### Copy Operation

After selecting the source song, press the ENTER/YES button. An “Are You Sure?” confirmation message appears in the display. Press the ENTER/YES button again to actually execute the copy operation. Press the EXIT/NO button to cancel.

**NOTE** If the current song is not empty and you attempt copying, you will see the “Sequence data is not empty” message. In this case, just press the ENTER/YES button, then press the EXIT/NO button to cancel the operation. Select an empty User song and redo the operation, or try copying track data from the source song (page 68).

## [Song2] Song Clear

You can clear all data recorded in the current User song.

[Song2]	Clear Current Song
▼SONG	

**NOTE** You can choose a track to clear all data recorded on it (page 68).

### Clear Operation

Press the ENTER/YES button. An “Are You Sure?” confirmation message appears in the display. Press the ENTER/YES button again to actually execute the clear operation. Press the EXIT/NO button to cancel.

## [Song3] Song Set

This page allows you to make basic settings for the current User song.

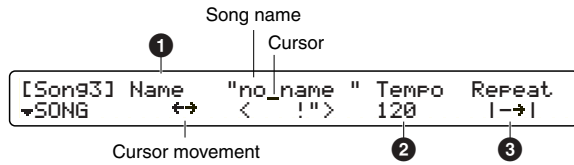

### 1 Name

As shown in the above diagram, use the second-to-left knob to move the cursor to the entry position, then use the center knob to enter a character at that position. Repeat this as needed to specify the song name (maximum of eight characters).

❑ **Available characters:**

!	"	#	\$	%	&	'	(	)	*	+	,	-	.	/	0	1	2	3	
4	5	6	7	8	9	:	:	<	=	>	?	@	A	B	C	D	E	F	G
H	I	J	K	L	M	N	O	P	Q	R	S	T	U	V	W	X	Y	Z	[
¥	]	^	_	`	a	b	c	d	e	f	g	h	i	j	k	l	m	n	o
p	q	r	s	t	u	v	w	x	y	z	{		}	→	←				

### 2 Tempo

Determines the initial song tempo.

❑ **Settings:** 30~300

**NOTE** Playback tempo can also be set for each drum kit (page 47), along with the song used with the kit. When you select a kit, the system tempo (in the default screen) will be reset to the specified tempo of the kit. If you then select a song with an initial tempo specified here, the system tempo will be reset to the tempo of the song. If this is inconvenient, you can temporarily disable all tempo settings contained or recorded in the song (page 82).

### 3 Repeat

Sets repeated song playback (the song plays from beginning to end and repeats). Set to icon so that song playback stops automatically at the end of the song.

❑ **Settings:** |→| (normal playback), |↺| (repeated playback)

## [Song4] Quantize Track

This lets you quantize the recorded data (page 62) on either track 1 or 2 of the current User song.

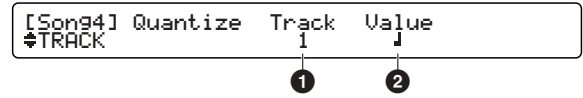

**NOTE** You may lose the groove of the recorded performance after quantization. Be sure that operation cannot be undone.

### 1 Track

Determines the target track to be quantized.

❑ **Settings:** 1, 2

### 2 Value

Determines the smallest note length (resolution) used for quantizing.

❑ **Settings:** Quarter note, quarter note triplet, 8th note, 8th note triplet, 16th note, 16th note triplet

## Quantize Operation

After selecting the target track, press the ENTER/YES button. An "Are You Sure?" confirmation message appears in the display. Press the ENTER/YES button again to actually execute the quantize operation. Press the EXIT/NO button to cancel.

## [Song5] Mix Track

This lets you merge all data on both tracks in the current song into either track 1 or 2.

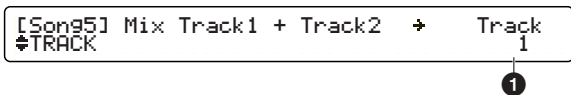

### 1 Track

Specify the track to which the mixed data will be written. Any track not selected here becomes empty after the mix operation.

Settings: 1, 2

## Mix Operation

After selecting the target track, press the ENTER/YES button. An “Are You Sure?” confirmation message appears in the display. Press the ENTER/YES button again to actually execute the mix operation. Press the EXIT/NO button to cancel.

## [Song6] Copy Track

This lets you copy a track from a Preset or User song to the specified track in the current User song. Any data that exists on the destination track will be overwritten and erased by the copied data.

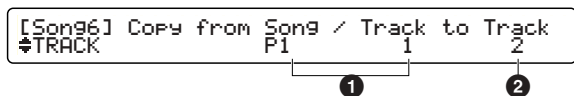

### 1 Copy from Song / Track

Select the source song using the center knob, and select the source track using the second-to-right knob.

Settings:

- Song number: Preset or User song (cannot be copied from a song on the memory card)
- Track number: 1, 2

### 2 to Track

Select the destination track of the current song.

Settings: 1, 2

## Copy Operation

After selecting the source song and track as well as the destination track of the current song, press the ENTER/YES button. An “Are You Sure?” confirmation message appears in the display. Press the ENTER/YES button again to actually execute the copy operation. Press the EXIT/NO button to cancel.

## [Song7] Clear Track

You can clear all data on the specified track in the current User song.

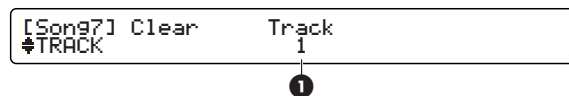

### 1 Track

Select the track you want to clear.

Settings: 1, 2

## Clear Operation

After selecting the target track, press the ENTER/YES button. An “Are You Sure?” confirmation message appears in the display. Press the ENTER/YES button again to actually execute the clear operation. Press the EXIT/NO button to cancel.

## [Song8] Copy Measure

This allows you to copy data from the specified measures in a track of a Preset or User song to a specified measure (and beyond) in a track of the current song. Any data in the destination measures will be overwritten and erased by the copied data.

**NOTE** This feature has two displays: one for source settings and the other for destination settings. You can specify the source in the first display, and the destination in the second display. Press the ENTER/YES button to move from the first to second display. Press the ENTER/YES button in the second display to start the copy operation. You can press the EXIT/NO button in the second display to return to the first display.

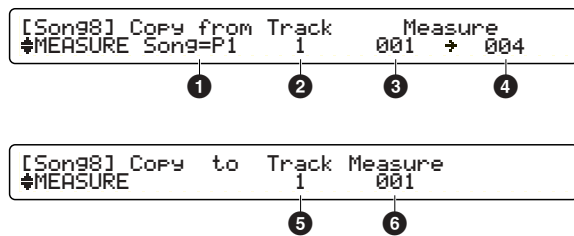

### 1 Copy from

Determines the source song.

**Settings:** Preset or User song (cannot be copied from a song on the memory card)

### 2 Track

Determines the source track of the source song.

**Settings:** 1, 2

### 3 Measure (from)

Determines the first measure of the track in the source song.

**Settings:** 001-999

### 4 Measure (to)

Determines the last measure of the track in the source song.

**Settings:** 001-999

### 5 Copy to Track

Determines the destination track number of the current User song.

**Settings:** 1, 2

### 6 Measure

Determines the first measure of the destination track in the current song. Data from the source song will be copied starting from the beginning of the measure specified here, and overwriting data in the current song (if any).

**Settings:** 001-999

## Copy Operation

After selecting the source (song, track, and measure range) in the first display, press the ENTER/YES button. Next, select the destination track and first measure for the current song (destination) in the second display. You can press the EXIT/NO button to move back to the first display for re-selecting the source. Press the ENTER/YES button. An "Are You Sure?" confirmation message appears in the display. Press the ENTER/YES button again to actually execute the copy operation, or press the EXIT/NO button to cancel. You can press the EXIT/NO button at any time above to cancel the operation.

**NOTE** The song may not play back as expected after the copy operation if you have overwritten measures containing Program Change events or other continuous MIDI data such as Control Change, Pitch Bend Change, and so on.

## [Song9] Create Measure

This allows you to insert an empty measure of the specified time signature at any point in the specified track of the current User song.

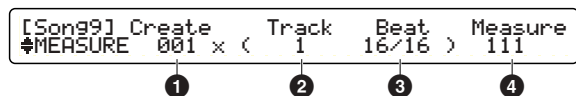

### 1 Create

Determines the number of empty measures to be inserted.

**Settings:** 001-999

### 2 Track

Determines the track where the empty measures will be inserted.

**Settings:** 1+2, 1, 2

**NOTE** Choosing a single track (1 or 2) will make it longer than the other track after inserting measures, causing the lengthened track to play behind. Choose both tracks (1+2) for a matched track length.

### 3 Beat

Determines the time signature of the measures to be inserted.

**Settings:** 1/4-16/4, 1/8-16/8, 1/16-16/16

### 4 Measure

Determines the starting point of the measures to be inserted. The specified number of empty measures will be inserted from this point onward.

**Settings:** 001-999

## Insert Operation

After selecting the number of measures and time signature as well as first measure and target track, press the ENTER/YES button. An “Are You Sure?” confirmation message appears in the display. Press the ENTER/YES button again to actually execute the insert operation. Press the EXIT/NO button to cancel.

**NOTE** If you specify a different time signature from that in existing measures, the display shows an event indicating a time signature in the timeline used in step recording. For example, if you insert 6/4-beat measures in the middle of 4/4-beat measures, the display shows “TimeSig 6/4” at the beginning of the first inserted measure and “TimeSig 4/4” immediately after the last inserted measure.

## [Song10] Delete Measure

This lets you delete measures (including recorded data) in the specified track in the current song. The remaining measures after the deleted portion will automatically be moved to fill the gap.

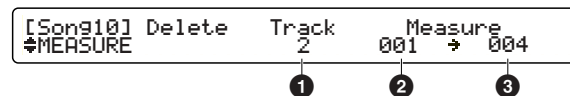

### 1 Track

Determines the target track.

**Settings:** 1+2, 1, 2

**NOTE** Choosing a single track (1 or 2) will make it shorter than the other track after deleting measures, causing the shortened track to play ahead. Choose both tracks (1+2) for a matched track length.

### 2 Measure (from)

Determines the first measure to be deleted.

**Settings:** 001-999

### 3 Measure (to)

Determines the last measure to be deleted.

**Settings:** 001-999

## Delete Operation

After selecting the target track and measure range, press the ENTER/YES button. An “Are You Sure?” confirmation message appears in the display. Press the ENTER/YES button again to actually delete the measures. Press the EXIT/NO button to cancel.

**NOTE** The song may not play back as expected after the delete operation if the deleted measures contained Program Change events or other continuous MIDI data such as Control Change, Pitch Bend Change, and so on.

## [Song11] Erase Measure

This lets you erase all data within the specified measures in a track of the current song. Since this deletes only the data, the target measures will become empty after the operation, and the measures after the erased portion will not be moved.

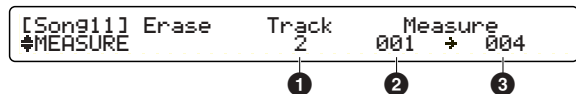

### 1 Track

Determines the target track.

**Settings:** 1, 2

### 2 Measure (from)

Determines the first measure to be erased.

**Settings:** 001-999

### 3 Measure (to)

Determines the last measure to be erased.

**Settings:** 001-999

## Erase Operation

After selecting the target track and measure range, press the ENTER/YES button. An “Are You Sure?” confirmation message appears in the display. Press the ENTER/YES button again to actually erase the data. Press the EXIT/NO button to cancel.

**NOTE** The song may not play back as expected after the erase operation if the erased measures contained Program Change events or other continuous MIDI data such as Control Change, Pitch Bend Change, and so on.

## [Song12], [Song13] & [Song14] Part Setup

Use these three pages to make settings for a custom MIDI ensemble using the built-in tone generator or external sound modules. The settings you make here are sent to MIDI parts internally or externally (via MIDI OUT or USB) the next time you call up and play the User song.

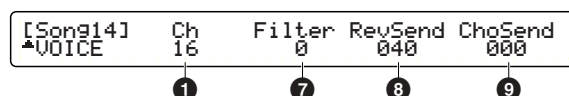
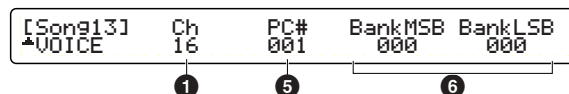
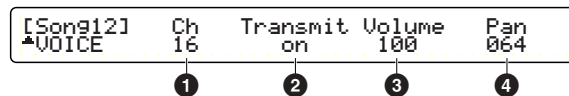

**NOTE** Similar MIDI part settings also exist for the User kits (page 54).

If you enable both MIDI part settings, settings for your MIDI parts will change, both on the DTXTREME II's built-in tone generator and the connected external sound modules — every time you select a User song or a User kit. Meanwhile, if you select a Preset kit or a User kit for which MIDI part settings are disabled, there is a chance that the recalled drum kit will not sound correctly or as expected. This will happen if the last recalled User song has changed settings for MIDI channel 10 (drum part). To play the recalled drum kit with the standard settings, simply select a Preset song. The current settings for MIDI channel 10 will automatically be changed to the standard default settings.

### 1 Ch

Determines the target MIDI channel (1 to 16).

**Settings:** 1-16

### 2 Transmit

Enables (on) or disables (off) transmission of the MIDI events specified by 3 to 9 below, over the target channel 1. When this is set to off, you cannot set values for 3 to 9 for the target channel 1, and “---” is shown in the display.

**Settings:** on, off

**3 Volume**

Determines the value for controller number 007 (volume). If used for the built-in tone generator, this determines the volume of each part.

❑ **Settings:** 000-127

**4 Pan**

Determines the value for controller number 010 (pan). If used for the built-in tone generator, this determines the stereo panning of each part.

❑ **Settings:** 000-064-127 (left to center to right)

**5 PC#**

Determines the program number you want to transmit. If used for the built-in tone generator, this specifies a GM voice.

❑ **Settings:** 001-128

**NOTE** If you want to effectively use the part selection buttons during song playback, use MIDI channel 3 for the bass part. The rhythm part including the drum kit is fixed to channel 10.

**6 BankMSB & BankLSB**

If you use an external sound module that has multiple sound banks, you can use these two events to select the desired bank. Use these in combination with the program number **5** parameter to select a specific sound program (voice).

❑ **Settings:** 000-127 (for both MSB and LSB)

**NOTE** The built-in tone generator has no sound banks. However, you can use the two bank select events to specify where your favorite drum kit is stored: Preset bank (MSB=125, LSB=0), User bank (MSB=125, LSB=1), or Card bank (MSB=125, LSB=2). Specify any Preset kit, User kit, or User kit on the memory card used with the current song.

**7 Filter**

Determines the value for controller number 074 (brightness or cut-off frequency). If used for the built-in tone generator, this affects the filter effect for each part.

❑ **Settings:** -64-0-+63

**8 RevSend**

Determines the value for controller number 091 (effect depth). If used for the built-in tone generator, this determines the master send level to the reverb effect (system effect) for each part.

❑ **Settings:** 000-127

**9 ChoSend**

Determines the value for controller number 093 (effect depth). If used for the built-in tone generator, this determines the master send level to the chorus effect (system effect) for each part.

❑ **Settings:** 000-127



# Utility Features

Utility features include overall settings of the DTXTREME IIs system, waveform sampling using the AUX IN jack on the front panel, and memory card functions. Press the UTILITY button on the top panel to access these features.

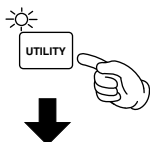

```
[UT 1] Low(Freq Gain) Mid(Freq Gain)
▼EQ      100Hz      + 0      800Hz      0
```

**NOTE** The first page that appears (the one last called up) may be different from the display shown above (page 76).

## Edit Pages and Basic Operations

Utility features are available in the following twenty-eight pages, divided into general editing categories — EQ, TG, SYSTEM, MIDI, CLICK, WAVE, and CARD.

```
[UT 1] Low(Freq Gain) Mid(Freq Gain)
▼EQ      100Hz      + 0      800Hz      0
```

```
[UT 2]                               High(Freq Gain)
▼EQ                               2.0kHz      0
```

```
[UT 3] MasterTune Vol SwapL/R RevByPas
▲TG      +000.0    127    off      on
```

```
[UT 4] IndivOut Slider AuxIn
▲TG      manual  Revsend  st+ph
```

```
[UT 5] LCDcont LEDdisf Learn JumpRecent
▲SYSTEM  32      drunkit  always  off
```

```
[UT 6] TrgLink TrgByPas TrgSet
▲SYSTEM  global  on      type1
```

```
[UT 7] FCoffset FCset IncFunc DecFunc
▲SYSTEM  +32     32     IN16   IN16
```

```
[UT 8]                               Factory Set
▲SYSTEM
```

```
[UT 9] Transmit Bulk Data
▲MIDI      all data
```

```
[UT 10] Dev.No DumpIntrvl MIDImode Merge
▲MIDI      all     150    native  off
```

```
[UT 11] Receive10 PC PC10 SysEx
▲MIDI      on     off   off     on
```

```
[UT 12] Local SendHH
▲MIDI      on     on
```

```
[UT 13] VoiceSet Output Mode MIDIOut
▲CLICK CowBell phones play&rec off
```

```
[UT 14] Type Voice[High] Vol Tuning
▲CLICK Percs1 11 Bell 127 +10.25
```

```
[UT 15] Type Voice[Mid] Vol Tuning
▲CLICK Percs1 21 Clvs 127 +10.25
```

```
[UT 16] Type Voice[Low] Vol Tuning
▲CLICK Percs1 110 WoodBloc 127 +10.25
```

```
[UT 17] MIDICtl SyncMode
▲SEQ      off   internal
```

```
[UT 18] UseTempo PlayCount RecCount
▲SEQ      song  off   on
```

```
[UT 19]                               Start LpStart End
▲WAVE      x100k 0000256 0000512 0001024
```

```
[UT 20] TrigLevel Source FreeMemory
▲WAVE      manual  left  4193792(95.0s)
```

```
[UT 21] Delete All Waves
▲WAVE
```

```
[UT 22] Load FileName
▲CARD allChain "DTXSET01"
```

```
[UT 23] Save FileName Volume
▲CARD all kit "INITWAVE" ↔
```

```
[UT 24] Delete FileName Volume
▲CARD all data "DTXSONG1"
```

```
[UT 25] Rename FromFile Volume
▲CARD all kit "INIT-SYS"
```

```
[UT 26] MoveWave FromFile ToVolume
▲CARD "VOLUME01 /NEW-FILE" VOLUME02
```

```
[UT 27] Create VolumeName
▲CARD VOLUME "UNTITLED" ↔
```

```
[UT 28] Format Smart Media
▲CARD
```

Use the leftmost knob to jump to the first page of each category, then immediately open the desired page by scrolling up or down with the Page buttons.

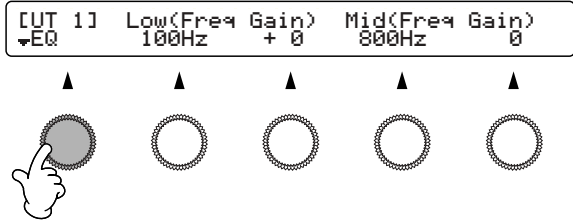

Also, refer to Basic Operations on page 20.

## [UT 1] & [UT 2] EQ

The EQ pages let you set the master equalizers that will be applied to the entire stereo output from the built-in tone generator. These EQ settings offer a parametric equalizer for the midrange, and a pair of shelving equalizers for the low and high frequencies.

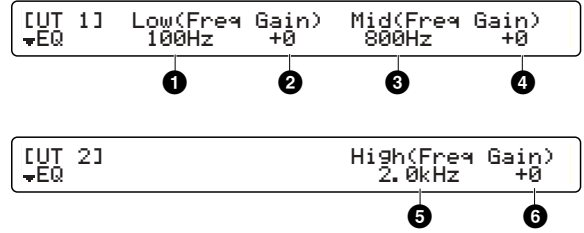

### 1 Low Freq

Determines the center frequency for the low frequency band.

□ **Settings:** 32Hz~2.0kHz

### 2 Low Gain

Determines the gain or level for the low frequency band.

□ **Settings:** -12~+12 (dB)

### 3 Mid Freq

Determines the center frequency for the mid frequency band.

□ **Settings:** 100Hz~10.0kHz

### 4 Mid Gain

Determines the gain or level for the mid frequency band.

□ **Settings:** -12~+12 (dB)

### 5 High Freq

Determines the center frequency for the high frequency band.

□ **Settings:** 500Hz~16.0kHz

### 6 High Gain

Determines the gain or level for the high frequency band.

□ **Settings:** -12~+12 (dB)

**NOTE** These three-band equalizers affect only the audio signals of the OUTPUT and PHONES jacks. They do not affect the audio of the INDIVIDUAL OUTPUT jacks.

## [UT 3] & [UT 4] Tone Generator

The Tone Generator pages determine the output settings for the sounds of the built-in tone generator.

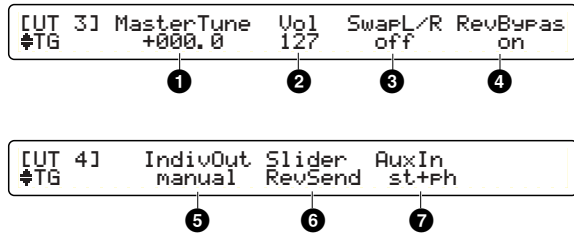

### 1 MasterTune

Determines the master pitch for the tone generator in 0.1-cent increments.

❑ **Settings:** -102.4-+102.4

### 2 Vol

Determines the master volume for the tone generator.

❑ **Settings:** 0-127

**NOTE** If the value here is set too low, the overall volume may be too low — even when setting the top panel sliders to the maximum position.

### 3 SwapL/R

Reverses the left and right positions of the drum voices. This setting is related to the panning position of each drum voice (page 50).

❑ **Settings:**

- off: Normal panning positions as specified for the drum voices.
- on: Reverse panning positions (the panning parameter for each drum voice also works in reverse).

### 4 RevBypas

Temporarily enable or disable the system effects (both reverb and chorus).

❑ **Settings:**

- off: System effects are enabled (normal).
- on: System effects are disabled.

### 5 IndivOut

Temporarily route the stereo-output drum voices to the INDIVIDUAL OUTPUT jacks. This setting is related to the output routing of each drum voice (page 53).

❑ **Settings:**

- manual: Normal output routings as specified for the drum voices.
- auto: Drum voices routed to the stereo OUTPUT are grouped into snare drum, bass drum, toms, hi-hats, cymbals, and other instruments and respectively sent to INDIVIDUAL OUTPUT jacks 1 to 6. Drum voices routed to InsFX go to insertion effects, and are then sent to the outputs specified for insertion effects.

### 6 Slider

Determines the control assignments for the panel sliders (SNARE, KICK, TOM, HI-HAT, CYMBAL or MISC) while the SHIFT button is held down.

❑ **Settings:**

- RevSend: Reverb send level for each drum voice.
- indiv: Output volume for each INDIVIDUAL OUTPUT 1 to 6.

**NOTE** If you've routed each drum voice to the stereo OUTPUT, there is no reason to set Slider to indiv.

### 7 AuxIn

Determines the output routing of the audio signals coming in from the AUX IN jack on the front panel.

❑ **Settings:**

- stereo: Sends to OUTPUT jack.
- phones: Sends to the PHONES jack.
- st+ph: Sends to both OUTPUT and PHONES jacks.

## [UT 5] System Utility

The System Utility page contains a variety of convenient system preference settings for easily and efficiently using the DTXTREME IIs system.

[UT 5] LCDcont	LEDdisp	Learn	JumpRecent
SYSTEM 32	drumkit	always	off
1	2	3	4

### 1 LCDcont

Determines the brightness and contrast of the LCD display.

❑ **Settings:** 0-63 (bright to dark; lower to higher contrast)

### 2 LEDdisp

Determines the LED display contents.

❑ **Settings:**

- drumkit: Shows the current drum kit number.
- tempo: Shows the current tempo.

### 3 Learn

This function allows you to have the note number associated with a particular trigger input automatically selected simply by hitting the corresponding pad. This is especially convenient when making trigger or voice settings.

❑ **Settings:**

- off: Disables the function.
- w/shift: Enables the function when the SHIFT button is held down.
- always: Enables the function at any time while editing trigger or voice settings.

### 4 JumpRecent

This function allows you to automatically return to the last selected display page for each of the function modes. This is a time-saving convenience when editing a variety of parameters, since it lets you go back to recent pages quickly.

❑ **Settings:**

- off: Always shows the first page in each mode.
- on: Shows the last opened page in each mode.

## [UT 6] & [UT 7] System Trigger

The System Trigger pages offer overall settings for the trigger inputs.

[UT 6] TrgLink	TrgByps	TrgSet	
SYSTEM global	on	type1	
1	2	3	
[UT 7] FCoffset	FCspt	IncFunc	DecFunc
SYSTEM +00	32	IN16	IN16
4	5	6	

### 1 TrgLink

Trigger link is a function that shares trigger settings of the User kit 1 (U1) with all other drum kits. With this function enabled, you can change the pad combinations for your system without having to change the trigger settings for each drum kit all over again.

❑ **Settings:**

- global: Enables shared trigger sets (including settings made in the [TrgSens1] to [TrgSes3] pages for the U1 kit).
- indiv: Enables a different trigger set for each drum kit.

**NOTE** The Trigger Link function lets you share the basic trigger-to-velocity conversion settings of the U1 kit. If you want identical settings from a specific trigger input, use the trigger copy function (page 44).

### 2 TrgByps

Trigger bypass is a function that temporarily disables the trigger inputs — useful for keeping your drum kit silent between sets in a performance, for example. Enabling this function (on) prevents pad hits from triggering/playing sounds and generating MIDI events. For normal performance, disable this function (off).

❑ **Settings:** off, on

**NOTE** You can also assign this function to a pad (page 37) or foot switch (page 46).

### 3 TrgSet

Determines the trigger settings for preset drum kits (page 21). Select one of the six different presets that is most suitable for your pad configuration.

□ Settings: type1-type6

Trigger Input Jack		Trigger Set					
		Type1	Type2	Type3	Type4	Type5	Type6
SNARE	1	TP 120SD	TP 120SD	any RHP	any RHP	TP 65S	any TP
TOM1	2	TP 100	TP 65S	any RHP	any TP	any TP	any TP
TOM2	3	TP 100	TP 65S	any RHP	any TP	any TP	any TP
TOM3	4	TP 100	TP 65S	any RHP	any TP	any TP	any TP
TOM4	5	TP 100	TP 65S	any RHP	any TP	any TP	any TP
RIDE	6	PCY 150S	PCY 150S	PCY 150S	any PCY	any PCY	any PCY
CRASH1	7	any PCY	any PCY	any PCY	any PCY	any PCY	any PCY
HI-HAT	8	RHH 130	RHH 130	RHH 130	any TP	any TP	any TP
KICK	9	any KP	any KP	KP 120	KP 120	any KP	any KP
(reserved)	10	any KP	any KP	KP 120	KP 120	any KP	any KP
CRASH2	11	any PCY	any PCY	any PCY	any PCY	any PCY	any PCY
(reserved)	12	any TP					
(reserved)	13	any PCY					
(reserved)	14	any TP					
(reserved)	15	any TP					
(reserved)	16	any TP					

NOTE Refer to the Trigger Settings (page 37) for details of pad types in the above table.

NOTE This function will be disabled if you enable the trigger link function in the same page.

### 4 FCoffset

Determines the precise pedal position at which the open hi-hat sound changes to a closed hi-hat sound, when using the hi-hat controller pedal. This function simulates the physical adjustment of the hi-hat opening (the space between the top and bottom cymbals). The smaller the value, the more narrow the “virtual” opening.

□ Settings: -32-0-+32

### 5 FCspt

Determines the length of time for a foot-splashed hi-hat sound played with the hi-hat controller (open hi-hat sound played only by the pedal). For larger values, you can play the foot-splashed sound more easily; however, slight movements of the pedal may trigger the sound inadvertently.

□ Settings: 0-127

### 6 IncFunc, DecFunc

A pad connected to the trigger input specified here can act as increment (IncFunc) or decrement (DecFunc) switch, regardless of its trigger function setting (page 37). You can enable its original trigger function by disabling the function here (off).

□ Settings: off, IN1-IN16

NOTE If you specify the same trigger input for both IncFunc and DecFunc, the connected pad will work only as an increment switch.

## [UT 8] Factory Set

This page allows for restoring the factory-set data into the DTXTREME IIs memory.

[UT 8] Factory Set  
SYSTEM

When you restore the factory settings, all current settings will be overwritten and lost. It is recommended that you back up important data to the memory card or other external storage media beforehand.

### Restoring Factory Set

When the display above is shown, press the ENTER/YES button. An “Are You Sure?” confirmation message appears in the display. Press the ENTER/YES button again to actually execute the factory set operation. The DTXTREME IIs will automatically reboot and restore itself to the status it was in when you turned it on for the first time. Press the EXIT/NO button to cancel the operation.

## [UT 9] MIDI Bulk Dump

This is the first MIDI page in this section, and allows you to transmit the memory contents of the DTXTREME IIs as bulk data (System Exclusive data). You can record that data to an external device such as Yamaha MDF3 MIDI Data Filer or a MIDI sequencer that is capable of recording System Exclusive messages.

```
[UT 9] Transmit Bulk Data
[MIDI] all data
```

1

### 1 Transmit Bulk Data

Determines the data type for transmission.

#### Settings:

- all data: Includes all data in the settings below.
- system: Includes all Utility and System settings.
- cur DKIT: Current drum kit (in the working buffer).
- all DKIT: Data for all User kits.
- curCHAIN: Data for the last selected chain (that is shown in the chain play display).
- allCHAIN: Data for all chains.
- cur SONG: Data for the current User song (not transmitted if a Preset song is selected).
- all SONG: Data for all User songs.

### Sending Bulk Data

First, you'll need to set up the external device used to receive the bulk data. Next, on the DTXTREME IIs, select the type of bulk data in the above display, and press the ENTER/YES button. An "Are You Sure?" confirmation message appears in the display. Press the ENTER/YES button again to actually execute the operation. When the bulk dump operation is finished, the previous display will be shown. Press the EXIT/NO button at any time to cancel the operation.

**NOTE** For proper reception on the external device, you may need to set the dump interval time.

### Receiving Bulk Data

Once you set the DTXTREME IIs to receive incoming bulk data (page 80), you can transmit it from the external device at any time. When the DTXTREME IIs starts receiving incoming bulk data, the following display appears.

```
Receiving Bulk data. in progress.
```

When the bulk loading process is finished, the display below appears briefly for a few seconds, and returns to the previous display.

```
Receiving Bulk data. completed.
```

**NOTE** When using one DTXTREME IIs unit to send bulk data to another DTXTREME IIs, make sure that the device number of both devices is set to the same value.

## [UT 10] MIDI I/O

The MIDI I/O page lets you specify how to send and receive MIDI data including bulk data and other standard MIDI events.

[UT 10]	Dev.No	DumpIntrvl	MIDI mode	Merge
#MIDI	all	150	native	off
	1	2	3	4

### 1 Dev.No

Determines the device number. When the same device number (1 to 16) is assigned, the DTXTREME IIs and another device can successfully exchange System Exclusive data (such as bulk data or parameter changes). The DTXTREME IIs can receive exclusive data all the time regardless of the device number, if you set this number to all.

**Settings:** all, 1-16

**NOTE** The device number is contained in System Exclusive data transmitted from the DTXTREME IIs. For this reason, you do not need to set the device number to a value other than all, so long as the setting data stored on another device is used only for a single DTXTREME IIs. However, if you use two or more DTXTREME IIs units together (and each have different settings), you'll need to be careful about the device number assignments for each unit.

### 2 DumpIntrvl

Determines the interval time between packets sent out during bulk dump. Set a larger value if sending bulk data to older or slower devices.

**Settings:** 50, 100, 150, 200, 250, 300 (milliseconds)

### 3 MIDI mode

Specify how the DTXTREME IIs responds to incoming Program Change data on MIDI channel 10. You'll also need to set the DTXTREME IIs to receive Program Change data on MIDI channel 10.

**Settings:**

- native: Selects regular drum kits.
- GM: Selects drum kits that correspond to GM program list (cannot select all kits).

Program number	Kit name
1	GM std 1
2	GM std 2
9	GM Room
17	GM Rock
25	GM Elec
26	GM Analg
33	GM Jazz
41	GM Brush
49	GM Clasc

### 4 Merge

This allows you to mix incoming MIDI data (received at MIDI IN) with MIDI data generated on the DTXTREME IIs, and output them together from MIDI OUT. Merge is enabled when this is set to on.

**Settings:** off, on

**NOTE** The Merge function is useful when you have an external MIDI controller and want to use both it and the DTXTREME IIs to control a connected tone generator.

## [UT 11] MIDI Receive

The MIDI Receive page lets you set how the built-in tone generator is controlled via MIDI. MIDI control includes external MIDI events and song playback from the built-in sequencer.

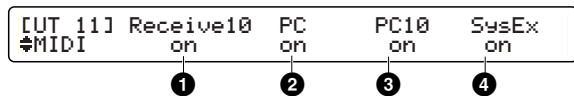

**HINT** When disabling MIDI control of the built-in tone generator, you can control (play) it only from the drum pads.

### 1 Receive10

Enable or disable reception of MIDI events incoming via channel 10 (channel messages). Set this to off if you want to play the built-in tone generator only from the pads and the Audition button.

**Settings:** off, on

**NOTE** Channel messages include Note On, Program Change, Control Change, Pitch Bend Change, and so on.

### 2 PC

Enable or disable reception of Program Change data. Set this to on if you want to select a voice program for each part using song settings or incoming Program Change data. Set this to off to select a voice program for other parts using the settings that have been programmed to the drum kit.

**Settings:** off, on

### 3 PC10

Enable or disable reception of Program Change data on channel 10. Set this parameter and PC 2 both to on if you want to select a drum kit using song settings or incoming Program Change data.

**Settings:** off, on

### 4 SysEx

Enable or disable reception of System Exclusive data. Set this to off if you do not want the DXTREME IIs to receive bulk data or parameter change messages.

**Settings:** off, on

## [UT 12] MIDI Send

The MIDI Send page lets you set how the built-in controllers affect the instrument. MIDI controllers include triggering using pads and song playback from the built-in sequencer.

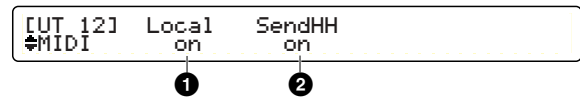

### 1 Local

Enable or disable the built-in controllers. Set this to off if you want to play the built-in tone generator only with external MIDI events from MIDI IN or USB.

**Settings:**

- off: MIDI events generated by pad play and song playback will only be sent out from MIDI OUT or USB, and not routed to the built-in tone generator.
- on: The built-in tone generator will sound by pad play and song playback (normal operation).

**NOTE** Since the built-in tone generator operates as a separate sound module when you set local control to off, it will become completely silent if you disable (set to off) all parameters found in the previous MIDI Receive page and shut out incoming MIDI events.

### 2 SendHH

Enable (on) or disable (off) transmitting of MIDI data generated by the hi-hat controller, from MIDI OUT or USB. You can specify the type of MIDI data in trigger settings (page 45).

**Settings:** off, on (default)

**NOTE** Continuous data from the hi-hat controller is always sent to the built-in tone generator, regardless of this setting.



## [UT 13] Click Basics

The Click Basics page lets you determine under what circumstances the click is played and what sound it uses.

[UT 13]	VoiceSet	Output	Mode	MIDIOut
#CLICK	CowBell	Phones	Play&rec	off
1	2	3	4	

### 1 VoiceSet

Allows you to select from nine preset click sounds, or your favorite voice. When you select user voice, you can specify it in the next Click Voice page.

**Settings:** Metronom, Cowbell, Claves, Stick, Man, FootStep, Count, Count+Sk, user vce

### 2 Output

Determines the output for the click sound. You can choose from stereo (OUTPUT), phones (PHONES), st+ph (OUTPUT and PHONE), indiv1 to indiv6 (one of the Individual Outputs), and ph+ind1 to ph+ind6 (PHONES and one of INDIVIDUAL OUTPUT).

**Settings:** stereo, phones, st+ph, indiv1-indiv6, ph+ind1-ph+ind6

### 3 Mode

Select how and under what circumstances the click is played. You can start or stop the click at any time. Also, the click can be set to automatically start or stop in sync with song playback and recording.

**Settings:**

- manual: Manually start or stop using the CLICK button.
- play: Sync to start or stop of song playback.
- rec: Sync to start or stop of song recording.
- play&rec: Sync to start or stop of song playback and recording.

### 4 MIDIOut

Select on if you want to send out the click count as MIDI events (Note On on MIDI channel 10).

**Settings:** off, on

## [UT 14], [UT 15] & [UT 16] Click Voice

The Click Voice pages features settings of the user click voice when it is selected in the previous Click Basics page. If you select a preset click sound, you cannot change the parameters below (“---” is shown in the display).

[UT 14]	Type	Voice[High]	Vol	Tuning
#CLICK	Percs1	11 Bell	127	+10.25
1	2	3	4	

[UT 15]	Type	Voice[Mid]	Vol	Tuning
#CLICK	Percs1	110 WoodBloc	127	+10.25
1	2	3	4	

[UT 16]	Type	Voice[Low]	Vol	Tuning
#CLICK	Percs1	110 WoodBloc	80	+10.25
1	2	3	4	

Each page offers the same parameters. Using any drum voice you like, you can set the accent beat sound (played on the first beat) in the [UT 14] page, on-beat sound (played on every beat other than the first) in the [UT 15] page, and off-beat sound (played between every beat) in the [UT 16] page, making a click pattern that clearly indicates each measure in any beat.

### 1 Type

Determines the voice category for the click sound.

**Settings:** Same as in voice settings (page 48).

### 2 Voice (High/Mid/Low)

Determines the voice from the specified category 1.

**Settings:** Drum voice number and name

### 3 Vol

Determines the volume of the specified drum voice 2.

**Settings:** 0-127

### 4 Tuning

Determines the pitch of the specified drum voice 2.

**Settings:** -24.00~+24.00

## [UT 17] & [UT 18] Sequencer

The SEQ pages let you specify how to operate the built-in sequencer.

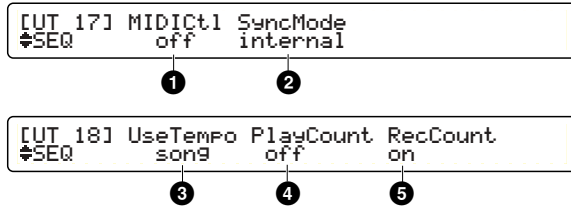

### 1 MIDICtl

Enable (on) or disable (off) sending and receiving MIDI System Real-time messages (Start, Stop, and Continue).

**Settings:** off, on

### 2 SyncMode

Enable or disable synchronization of the built-in sequencer.

**Settings:**

- internal: The built-in sequencer runs in sync to the DTXTREME IIs internal clock.
- external: The built-in sequencer runs in sync to MIDI timing clock (F8) received via MIDI IN or USB.

**NOTE** If you want DTXTREME IIs to completely sync to an external device, set MIDICtl **1** to on and SyncMode **2** to external. The built-in sequencer will start or stop in sync to an external rhythm machine or sequencer, while running at that device's tempo.

### 3 UseTempo

Enable or disable using the tempo information assigned to a song or drum kit.

**Settings:**

- song: Enables the tempo information set in the song or a drum kit.
- global: Disables the tempo information set in the song or a drum kit and enables the tempo that is manually adjusted.

**NOTE** You'll need to specify the tempo on the connected external device if you set SyncMode **2** to external.

### 4 PlayCount

Enable or disable a two-measure click count before actual song playback after you press the Start/Stop button.

**Settings:** off, on

### 5 RecCount

Enable or disable a two-measure click count before actual song recording after you press the Start/Stop button.

**Settings:** off, on

## Sampling Feature

You can use the front panel AUX IN jack to input line level audio signals from a CD player or other devices, and you can record these signals digitally as waveform samples. Once a sample is captured, you can edit it simply to use as original drum voice. This sampling function is available from the WAVE pages in the utility features.

```
[UT 19]
#WAVE      x100k   Start   LeStart   End
           0000256 0000512 0001024
```

```
[UT 20] TrigLevel Source   FreeMemory
#WAVE      manual   left 4193792(95.0s)
```

```
[UT 21]      Delete All Waves
#WAVE
```

**NOTE** If you want to use a captured sample as drum voice, first save it to the memory card after editing. Since the captured sample will be lost when you turn DTXTREME IIs off, make sure prepare a memory card before you start sampling.

## [UT 20] Sampling Setup

Connect an audio source to the AUX IN jack on the front panel, and adjust the input level using the AUX VOL control. Open the second WAVE page ([UT 20]) and set the following parameters.

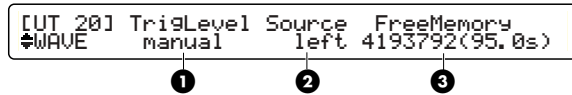

### 1 TrgLevel

Determines how sample recording is started.

#### Settings:

- manual: Select this if you start recording manually while monitoring the audio source (default).
- 1%-99%: Set the threshold input level if you want to automatically start recording when the input level exceeds the specified level.

### 2 Source

Determines the audio channel you want to record. If the connected audio source is mono, you can select any value.

Settings: left, right, L/Rmix (Left+Right)

### 3 FreeMemory

Available memory for sample recording will be shown in both memory size (in bytes) and time length (in seconds). You can record a mono sample of up to 95 seconds in length. If you already loaded waveform data, available sampling time will be shortened accordingly.

**NOTE** Sample data and waveform data, which is loaded from the memory card, share the same internal memory space. If the waveform data loaded for a User kit is occupying memory space, you'll need to delete it beforehand (page 84).

## Recording a Sample

Once you've set up the DTXTREME IIs for sampling, start recording.

**NOTE** If you attempt a series of recording, the second recording will be done by erasing the sample from the first recording. If you use the sample for waveform data, save it to the memory card (page 87) before the second recording.

1. Press the Record button in the transport control. The following display will appear. When you set the threshold level, the display shows the threshold setting as a bar, and recording automatically starts when the audio source (reaching to that level) is played.

#### Manual start:

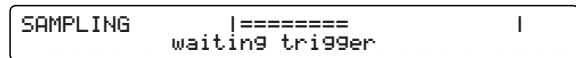

#### Auto start:

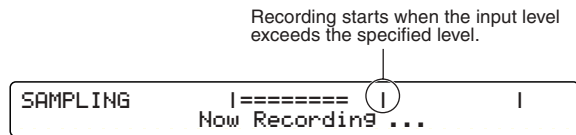

You can visually monitor the input level of the audio source in either display. For manual recording, if necessary, you can adjust the level using the AUX IN VOL control.

**NOTE** You can start sample recording from any WAVE page when pressing the Record button to call up one of the above displays.

2. Start playback of the audio source. In automatic recording, sampling will start when the input level exceeds the specified level. In manual recording, press the Start/Stop button in the transport control.
3. Press the Start/Stop button to finish recording. Recording will automatically stop if the memory is full.

When displaying a WAVE page, you can play the captured sample by pressing the Start/Stop button or the Audition button. (The captured sample can also be played by hitting any pad.) To stop the sample playback, simply press the Start/Stop button, or the Audition button while holding down the SHIFT button. If necessary, edit the captured sample.

## [UT 19] Editing a Sample

You can go back to the first WAVE page ([UT 19]) to adjust the start and end addresses of the captured sample for better playback timing or a smoother loop setting. Note that you need to save the sample to a memory card to use it as a drum voice.

[UT 19]	Start	LpStart	End
#WAVE	x100K	0000256	0000512 0001024
1	2	3	4

**NOTE** Sample editing functions in the WAVE page work only for a captured sample. You cannot use it for editing waveform data loaded from the memory card.

### 1 Editing step

Specify the editing step to increase or decrease a sample address turning the knob. For coarse adjustment, use a large step value. For fine adjustment, use a small step value.

□ **Settings:** x1, x10, x1k, x10k, x100k (k=1,000 bytes)

### 2 Start

Specify the start point for playback. You can cut off any unnecessary portion at the beginning by setting a value greater than zero (or turning the corresponding knob clockwise).

### 3 LpStart

Specify the loop point. Select loopOff for a one-shot voice. If you set an address value, the sample becomes looped. Setting the same address as the start point, the sample repeats the start point to the end point. Setting an address larger than the start point, the sample first plays from the start point to the end point, and then repeats the loop point to the end point.

### 4 End

Specify the end point for playback. You can cut off any unnecessary portion at the end by setting a value smaller than the original address (or turning the corresponding knob counter-clockwise).

**NOTE** Address settings for start, loop, and end points are represented as  $\text{start point} \leq \text{loop point} \leq \text{end point}$ . While editing, you can audition the sample using the Start/Stop button.

## [UT 21] Deleting a Sample

You can use the third WAVE page ([UT 21]) to delete all waveform data and sample data currently residing in the DTXTREME II's memory. This helps free up additional memory for sample recording.

[UT 21]	Delete All Waves
#WAVE	

When the above display is shown, press the ENTER/YES button. An "Are You Sure?" confirmation message appears in the display. Press the ENTER/YES button again to actually execute the sample delete operation. Press the EXIT/NO button to cancel.

## Memory Card Feature

You can store up to 40 drum kits (U1 to U40), up to 32 songs (U1 to U32), and 32 chains in the DTXXTREME IIs internal memory. Moreover, an external memory card (SmartMedia) allows for storing many more kits, songs, and chains — as many as you want. The memory card is also useful for storing waveform samples captured on the DTXXTREME IIs and for transfer of other audio files from a computer — so you can use them for additional drum voices. Various memory card functions are available from the CARD pages in the utility features.

```
[UT 22] Load   FileName  
*CARD allChain "DTXSET01"
```

```
[UT 23] Save   FileName      Volume  
*CARD all kit "INITWAVE" ↔
```

```
[UT 24] Delete FileName      Volume  
*CARD all data "DTXSONG1"
```

```
[UT 25] Rename FromFile      Volume  
*CARD all kit "INIT-SYS"
```

```
[UT 26] MoveWave FromFile    ToVolume  
*CARD "VOLUME01 /NEW-FILE" VOLUME02
```

```
[UT 27] Create  VolumeName  
*CARD VOLUME "UNTITLED" ↔
```

```
[UT 28]          Format Smart Media  
*CARD
```

**NOTE** For more details and precautions on using memory cards with the DTXXTREME IIs, refer to the section “Handling the Memory Card” in the Appendix.

## [UT 28] Formatting a Memory Card

Your new memory card must be formatted before use. You can format it in the last WAVE page.

```
[UT 28]          Format Smart Media  
*CARD
```

**NOTE** DTXXTREME IIs formats a memory card in MS-DOS (with the FAT16 file system), generally used for PC disk media. As a result, the formatted memory card can also be used with a computer, if you use a compatible card reader/writer. You can also format the memory card on the computer; however, for best results and to avoid read/write errors, always use cards that have been formatted on the DTXXTREME IIs.

### Format Operation

Hold the memory card so that its connector portion (gold) is facing up, insert it into the Card slot, and then press the ENTER/YES button. An “Are You Sure?” confirmation message will appear in the display. Press the ENTER/YES button to start formatting the card. Press the EXIT/NO button to cancel the operation. The display will show “Now executing, Please wait.” during formatting, and will show “Done.” when the operation is complete, before returning to the previous display.



If data is already saved on the memory card, be careful not to format it. If you format the memory card, all the previously recorded data will be deleted.

## Directory Structure and Stored Data Type

A properly formatted memory card has the following directory tree. Each operation in the CARD pages (read, write, rename, delete, and so on) is performed to a specific directory in the tree, depending on the type of data that is selected.

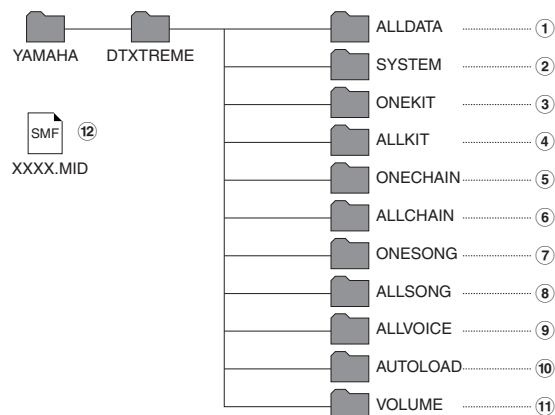

- ① The **ALLDATA** directory stores a file that contains all setting data for DTXTREME IIs. This directory is used when you select all data for the target data type in each CARD operation.
- ② The **SYSTEM** directory stores a file that contains settings available in SYSTEM pages in utility features. This directory is used when you select system for the target data type in each CARD operation.
- ③ The **ONEKIT** directory stores a file that contains settings for the current drum kit (in the working buffer). This directory is used when you select one kit for the target data type in each CARD operation.
- ④ The **ALLKIT** directory stores a file that contains settings for all User kits (U1 to U40). This directory is used when you select all kit for the target data type in each CARD operation.
- ⑤ The **ONECHAIN** directory stores a file that contains settings for the current chain (in the working buffer). This directory is used when you select oneChain for the target data type in each CARD operation.
- ⑥ The **ALLCHAIN** directory stores a file that contains settings for all chains (1 to 32). This directory is used when you select allChain for the target data type in each CARD operation.
- ⑦ The **ONESONG** directory stores a file that contains settings for the current User song. This directory is used when you select oneSong for the target data type in each CARD operation.

- ⑧ The **ALLSONG** directory stores a file that contains settings for all User songs (U1 to U32). This directory is used when you select all song for the target data type in each CARD operation.
- ⑨ The **ALLVOICE** directory stores a file that contains settings for all user voices. This directory is used when you select allVoice for the target data type in each CARD operation.

**NOTE** User voices are created using external System Exclusive parameter change data. Since they cannot be created on the DTXTREME IIs itself, you will not normally select allVoice.

- ⑩ The **AUTOLOAD** directory is used to load sample files. If you store an AIFF or WAV audio file in this directory on the computer, the DTXTREME IIs will automatically load that file when it is turned on. You can use the auto-loaded sample as an original drum voice. For your information, an auto-loaded sample must have an eight-character name beginning with a two-digit number (01 to 99), followed by a character that specifies which slider can control the volume level of that audio file (drum voice). The character must be C, H, K, M, S or T—CYMBAL, HI-HAT, KICK, MISC, SNARE or TOM. Plus, you need to end the name with a three-character extension. Names such as “01SFAT.AIF” (No.01 Fat Snare) or “32CSWISH.WAV” (No.32 Swish Cymbal) enable to control the sample volume with an appropriate slider.

**NOTE** The AUTOLOAD directory is used only in association with a computer. You cannot use it with CARD operations.

- ⑪ The **VOLUME** directory is a parent directory used to store a waveform sample captured on the DTXTREME IIs. If you create a volume (page 87), it will be created as a subdirectory contained in the VOLUME directory. You can use this subdirectory to store your captured samples, and specify it as wave directory (page 47) for your custom drum kit samples.

**NOTE** You can use your computer to make a volume (subdirectory) inside the VOLUME directory. Once you make a volume, it can also be used to store all necessary files — drum kits, songs, chains, waveform samples, and even AIFF or WAV audio files created on the computer — for specific situations, such as recording sessions or live performances, for which you want to load all necessary files with a single CARD operation. You need a computer to transfer the necessary files to the subdirectory (they cannot be transferred using the CARD operation).

- ⑫ When you want to play an SMF (Standard MIDI File Type 0) MIDI file on the DTXTREME IIs, specify its name with an eight-character name beginning with a two-digit number (01 to 99) plus a “.MID” extension (i.e., MYSONG.MID) and put it in the root directory (where the YAMAHA directory resides) of the memory card. You can select and play the MIDI file when you specify a song from the card (C1 to C99) with the appropriate card inserted in the CARD slot.

(Continued to next page)

(Continued from previous page)

## Naming Rule

When you save your DTXTREME IIs data to a memory card, you'll need to follow the MS-DOS naming conventions for file and volume names. You can use the same characters as those for a User kit or song (page 47), but the following characters will be replaced with an underscore (\_).

- ❑ **Illegal characters are:** (space), a-z (lowercase alphabet), and other miscellaneous characters (" ' \* + , . / : ; < = > ? ' \ | )

## [UT 27] Creating a Volume

Before capturing a waveform sample on the DTXTREME IIs and storing it, you'll need to create a special volume on the memory card.



### 1 VolumeName

Enter the desired name for the new volume, using up to eight characters. Use the second-to-right knob to move the entry position (cursor) for each character. Then, use the center knob to enter a character at that position. Repeat this step and enter the chain name (maximum of eight characters).

## Create Operation

When you finish all necessary settings, press the ENTER/YES button. An "Are You Sure?" confirmation message will appear in the display. Press the ENTER/YES button to create the volume. Press the EXIT/NO button to cancel the operation. The display will show "Now executing, Please wait." during the operation, and will show "Done." when the volume has been created, before returning to the previous display.

- ❑ **NOTE** If you enter a name that is the same as that of an existing volume (subdirectory) in the same location, the create operation cannot be executed. Specify another name for the new volume. In addition, you cannot rename an existing volume on the DTXTREME IIs, but you can do so on a computer.

## [UT 23] Saving a Data File

You can save specific data in the DTXTREME IIs memory as a file on the memory card.



### 1 Save

Determines the data type to be saved.

- ❑ **Settings:** all data, system, one kit, all kit, oneChain, allChain, one song, all song, allVoice, wave

- ❑ **NOTE** When saving a waveform sample (wave), appropriately specify its file name with up to eight characters beginning with a two-digit number (00 to 99; used as voice number when loaded), followed by the character that represents a slider for volume control (C, H, K, M, S or T—representing CYMBAL, HI-HAT, KICK, MISC, SNARE or TOM). Also, the file name must have a three-character extension (AIF or WAV).

### 2 FileName

Enter the desired name for the new file, using up to eight characters. Use the second-to-right knob to move the entry position (cursor) for each character. Then, use the center knob to enter a character at that position. Repeat this step and enter the chain name (maximum of eight characters).

### 3 Volume

Specify the destination volume when you select wave for the data type 1. If you see "no file" in the display, no volume has been prepared for saving the waveform sample. First create a volume and attempt the operation again.

- ❑ **NOTE** When saving a waveform sample (wave), appropriately specify its file name with up to eight characters beginning with a two-digit number (00 to 99; used as voice number when loaded), followed by the character that represents a slider for volume control (C, H, K, M, S or T—representing CYMBAL, HI-HAT, KICK, MISC, SNARE or TOM). Also, the file name must have a three-character extension (AIF or WAV).

## Save Operation

When you finish all necessary settings, press the ENTER/YES button. An "Are You Sure?" confirmation message will appear in the display. Press the ENTER/YES button to save the file. Press the EXIT/NO button to cancel the operation. The display will show "Now executing, Please wait." during the operation, and will show "Done." when the file has been saved, before returning to the previous display.

- ❑ **NOTE** If you enter a name that is the same as that of an existing file in the same location and press the ENTER/YES button, a "File exist. Overwrite?" message appears. Press the ENTER/YES button again to overwrite the file, or press the EXIT/NO button to cancel the operation.

## [UT 22] Loading a Data File

You can load a specific data file from the memory card.

```
[UT 22] Load  FileName  
▲CARD allChain "DTXSET01"
```

1 2

### 1 Load

Determines the data type to be loaded into the DTXTREME II's memory. If you select one data, it will be loaded in the working buffer (page 35). If you select all data, it will be loaded in the user memory (for drum kits or songs). If you select VOLUME, all data files in the specified volume (directory) will be loaded.

□ **Settings:** all data, system, one kit, all kit, oneChain, allChain, one song, all song, allVoice, SMF, VOLUME

### 2 FileName

Determines the file or volume to be loaded. If there is no file for the specified data type 1, "no file" will be shown.

## Load Operation

When you finish all necessary settings, press the ENTER/YES button. An "Are You Sure?" confirmation message will appear in the display. Press the ENTER/YES button to load the data file. Press the EXIT/NO button to cancel the operation. The display will show "Now executing, Please wait." during the operation, and will show "Done." when the file has been loaded, before returning to the previous display.

## [UT 24] Deleting a Data File

You can delete a specific data file on the memory card.

```
[UT 24] Delete  FileName  Volume  
▲CARD all data "DTXSONG1"
```

1 2 3

### 1 Delete

Determines the data type.

□ **Settings:** all data, system, one kit, all kit, oneChain, allChain, one song, all song, allVoice, wave, volume

### 2 FileName

Determines the file or volume to be deleted. If there is no file for the specified data type 1, "no file" will be shown.

### 3 Volume

Determines the destination volume when you select wave for the data type 1 and specify the target file 2. If you see "no file" in the display, you there is no target volume or file on the memory card.

## Delete Operation

When you finish all necessary settings, press the ENTER/YES button. An "Are You Sure?" confirmation message will appear in the display. Press the ENTER/YES button to delete the file. Press the EXIT/NO button to cancel the operation. The display will show "Now executing, Please wait." during the operation, and will show "Done." when the file has been deleted, before returning to the previous display.

**NOTE** You can also delete an empty volume by specifying "volume" for the data type 1 and the target volume 2. You may need to delete all files in the specified volume beforehand.



## [UT 25] Renaming a Data File

You can rename a specific data file on the memory card. This operation will use two displays, one for specifying the target file and the other for specifying a new file name.

```
[UT 25] Rename FromFile Volume
^CARD all kit "INIT-SYS"
```

1 2 3

### 1 Rename

Determines the data type.

□ **Settings:** all data, system, one kit, all kit, oneChain, allChain, one song, all song, allVoice, wave

### 2 FromFile

Determines the file or volume to be renamed. If there is no file for the specified data type 1, “no file” will be shown.

### 3 Volume

Determines the destination volume when you select wave for the data type 1 and specify the target file 2. If you see “no file” in the display, you have no target volume or file on the memory card.

When you specify the target file, press the ENTER/YES button to move to the second display. Press the EXIT/NO button to cancel the operation.

```
[UT 25] Rename ToFile
^CARD all data "INIT-SYS" ↔
```

4

### 4 ToFile

Enter the desired name for the new file, using up to eight characters. Use the second-to-right knob to move the entry position (cursor) for each character. Then, use the center knob to enter a character at that position. Repeat this step and enter the chain name (maximum of eight characters).

## Rename Operation

When you finish all necessary settings, press the ENTER/YES button. An “Are You Sure?” confirmation message will appear in the display. Press the ENTER/YES button to rename the file. Press the EXIT/NO button to cancel the operation. The display will show “Now executing, Please wait.” during the operation, and will show “Done.” when the file has been renamed, before returning to the first display.

NOTE If you do not specify a new name, you cannot execute the rename operation. To cancel renaming, press the EXIT/NO button.

## [UT 26] Moving a Sample File

You can move a sample file between volumes (subdirectories inside the VOLUME directory).

```
[UT 26] MoveWave FromFile ToVolume
^CARD "VOLUME01 /NEW-FILE" VOLUME02
```

1 2

### 1 MoveWave / FromFile

Specify the source volume for FromFile, and then specify the target file in that volume for MoveWave.

### 2 ToVolume

Specify the destination volume.

## Move Operation

When you finish all necessary settings, press the ENTER/YES button. An “Are You Sure?” confirmation message will appear in the display. Press the ENTER/YES button to move the sample file. Press the EXIT/NO button to cancel the operation. The display will show “Now executing, Please wait.” during the operation, and will show “Done.” when the file has been moved, before returning to the first display.

NOTE If you specify the same volume for both FromFile 1 and ToVolume 2, the move operation cannot be executed.

# Appendix

## Handling the Memory Card (SmartMedia™\*)

Be sure to handle Memory Cards with care. Follow the important precautions below.

\* SmartMedia is a trademark of Toshiba Corporation.

### ■ Compatible Memory Card Type

3.3V(3V) Memory Cards can be used. 5V type Memory Cards are not compatible with this instrument.

### ■ Memory Capacity

There are five types of Memory Cards: 2MB/4MB/8MB/16MB/32MB. A Memory Card with the memory capacity exceeding 32MB can also be used if it conforms to the standards of SSFDC (Solid State Floppy Disk Card: another name of SmartMedia) Forum.

### ■ Inserting/Removing Memory Cards

#### • To insert a Memory Card:

Hold the Memory Card so that the connector section (gold) of the Memory Card is facing upward and forward, towards the Memory Card slot. Carefully insert the Memory Card into the slot, slowly pushing it all the way in until it is fitted in place.

Don't insert the Memory Card in wrong direction.

Don't insert anything other than a Memory Card in the slot.

#### • To remove a Memory Card:

Before removing the Memory Card, be sure to confirm that the Memory Card is not in use, or it is not being accessed by the instrument. Then pull the Memory Card out slowly by hand. If the Memory Card is being accessed\*, a message indicating that it is in use appears on the instrument's display.

\* It includes saving, loading, formatting, deleting and making directory. Also, be aware that the instrument will automatically access the Memory Card to check the media type when it is inserted while the instrument is turned on.



Never attempt to remove the Memory Card or turn the power off during accessing. Doing so can damage the data on the instrument/Memory Card and possibly the Memory Card itself.

### ■ Formatting Memory Cards

Before using a Memory Card with your instrument it must first be formatted. Once it is formatted all data on it will be erased. Be sure to check if the data is unnecessary for you or not, beforehand.

**NOTE** The Memory Cards formatted with this instrument may become unusable with other instruments.

### ■ About the Memory Cards

#### • To handle Memory Cards with care:

There are times when static electricity affects Memory Cards. Before you handle Memory Cards, to reduce the possibility of static electricity, touch the metal parts such as a door knob and aluminum sash.

Be sure to remove the Memory Card from the Memory Card slot when it is not in use for a long time.

Do not expose the Memory Card to direct sunlight, extremely high or low temperatures, or excessive humidity, dust or liquids.

Do not place heavy objects on a Memory Card or bend or apply pressure to the Memory Card in any way.

Do not touch the metal part (gold) of the Memory Card or put any metallic plate onto the metal part.

Do not expose the Memory Card to magnetic fields, such as those produced by televisions, speakers, motors, etc., since magnetic fields can partially or completely erase data on the Memory Card, rendering it unreadable.

Do not attach anything other than the provided labels to a Memory Card. Also make sure that labels are attached in the proper location.

#### • To protect your data (Write-protect):

To prevent inadvertent erasure of important data, stick the write-protect seal (provided in the Memory Card package) onto the designated area (within a circle) of the Memory Card.

Conversely speaking, to save data on the Memory Card, make sure to remove the write-protect seal from the Card. Do not reuse the seal that is peeled off.

### ■ Data Backup

For maximum data security Yamaha recommends that you keep two copies of important data on separate Memory Cards. This gives you a backup if one Memory Card is lost or damaged.

# Troubleshooting

---

## The DTXTREME IIs is Not Making a Sound or a Triggered Sound

---

- Make sure the pads and triggers are connected correctly to the input jacks of the DTXTREME IIs.
- Make sure the connectors from the DTXTREME IIs OUTPUT jack (and NOT the INDIV. OUT jack) are plugged correctly to the input jacks of the amplifier or mixer.
- Raise the volume by using the volume slider.
- Make sure the input level is displayed on the LCD when you play the pad or drum with a trigger.
- Raise the minimum value of the level range.
- Make sure the output settings of the voice is not “INDIV. OUT.”
- Make sure the Trigger Bypass switch in Utility mode is OFF .
- Check the Local Control in Utility mode. The Local Control should be “on.”
- Check the cables.

## The External Tone Generator is Not Making a Sound

---

- Make sure the MIDI connectors are correctly connected.
- Make sure the MIDI channels match the input jack numbers of the connected external devices.
- Make sure the value of the MIDI note numbers are set correctly.
- Make sure the Trigger Bypass switch in Utility mode is “off.”

## The Sound does not Match the Settings

---

- Make sure you have not plugged the monaural phone plug when the power is still ON. This sets the rim switch ON on the DTXTREME IIs. Turn the power OFF and ON again.
- Make sure the output MIDI channel is set to Drum Voice (ch=10).
- Make sure the pad type is set correctly. If set incorrectly, the mute and edge functions will not work properly.

## The Velocity (Sound) is Too Small

---

- Raise the gain setting.
- If the pads have an output or velocity control volume, adjust them (by raising them).
- Raise the velocity.
- Try a different velocity curve.
- Raise the volume of the voice.
- Make sure the input type is correct.
- Reset the INPUT ATTENUATION switch on the rear panel.

## The Triggered Sound is Not Stable (When using acoustic drums)

---

- Make sure you have select the correct input type. Try a larger drum.
- Make sure the trigger pickup (DT series) is securely fastened with new sticky tape.
- Make sure the cable is securely inserted into the DT series jack.

## Double-triggering

---

- If you are using a sensor made by other manufacturers, it may be sending a large signal causing double-triggering.
- Make sure the head is not causing irregular vibration. If it is, it is necessary to mute the head.
- Make sure the sensor is fixed near the rim (above the bearing) and not near the center of the head.
- Make sure that nothing is touching the sensor.
- If the pads have an output or velocity control volume, adjust them (by lowering them).
- Raise the rejection parameter. Be careful not to set it too high or it may cause a sound to be muted when another drum is played at the same time.
- Try switching the INPUT ATTENUATION switch on the rear panel.

## You are Experiencing “Crosstalk”

---

- Replace the sensor away from the nearby drum.
- The minimum input level needs to be higher.
- Raise the gain setting.
- Raise the rejection parameter.

## The Sounds are Cut when you Play Continuously

---

- If you are playing a rim shot, set the RIM Velocity parameter in Drum Kit Trigger Edit mode to a setting other than “mute hi” and “mute lo.”
- Set the unnecessary 2nd notes on to “off” in Drum Kit Trigger Edit mode.
- Set the Key mode in Drum Kit Voice Edit mode to “semi2,” “semi3,” “semi4” and so on.

## Only 1 Sound is Heard when 2 Pads (Drums) are Played

---

- Raise the gain setting of the pad (drum) that is not making a sound.
- Lower the rejection parameter of the pad (drum) that is not making a sound.
- Make sure that the pads (drums) are not assigned to the same group in the Alternate Group settings in Drum Kit Voice Edit mode.

## The Sound is Too Loud (The Velocity is Permanently Too High)

---

- Lower the gain setting.
- Lower the minimum value of the velocity range.
- Try another velocity curve.
- If you are using a sensor made by other manufacturers, it may be sending a large signal.
- Reset the INPUT ATTENUATION switch on the rear panel.

## The Footswitch Works Oppositely

---

- Turn the power switch on again with the footswitch connected to the rear panel. The DTXTREME IIs will automatically detect the polarity of the switch and enable regular operation. (If the power is currently ON, turn it OFF once and then ON again).
- Make sure you are not stepping on the footswitch when you turn the power ON.

## The Bass or Chord Patterns do Not Play in Pattern or Song Mode

---

- Make sure the tracks are not muted.
- Make sure the Tr parameter in Song Play mode is not set to “mute.”

## The DTXTREME IIs does Not Receive any Switch or Trigger Data

---

- A data error has occurred. Turn the power OFF and then ON while holding the Play and Trigger buttons and the DTXTREME IIs will reset to its initial settings. Beware that all the data will be lost. Frequent data back-up storage to external MIDI devices such as the Yamaha MDF3 is recommended to prevent lost data.

## The Sound will Not Stop

---

- Some sounds may have an extremely long release when the Rev Key Off function is enabled. In such a case, press the Audition button while holding SHIFT to temporarily stop the sound.

# Error Messages

---

```
ERROR : MIDI input buffer full
                Push [ENTER]
```

MIDI buffer memory has become full by receiving too much MIDI data at a time via MIDI IN or TO HOST. Reduce the amount of data (data transfer rate) or increase the interval between each transfer on the sending device.

```
ERROR : MIDI data error
                Push [ENTER]
```

An error has occurred while MIDI data was being received. Check if the MIDI cable is properly connected and if the MIDI data is appropriate.

```
WARNING: All data initialized
                Push [ENTER]
```

All setting data is initialized because the backup battery inside the DTXTREME IIs may be running short. Consult your nearest Yamaha dealer on replacing the battery.

```
WARNING : Battery voltage is low
                Push [ENTER]
```

The backup battery inside the DTXTREME IIs may be running low. All setting data may be lost if the DTXTREME IIs is turned off after this message is shown. First try to save necessary data to a memory card or so on, then consult your nearest Yamaha dealer on replacing the battery.

```
ERROR : MIDI check sum error
                Push [ENTER]
```

Checksum of the received bulk data is incorrect. Check if the data is not corrupted and appropriate for the DTXTREME IIs, and then retry.

```
ERROR : MIDI Illegal data
                Push [ENTER]
```

Received bulk data contains illegal data. Check if the data is not corrupted and appropriate for the DTXTREME IIs, and then retry.

```
ERROR : Sequencer is Running
                Push [ENTER]
```

This message will be shown if you attempt an operation while the internal sequencer is running. Stop the sequencer and retry.

```
ERROR : Sequence data is not empty
                Push [ENTER]
```

This message will be shown if you attempt recording to operation to the track that contains data. Retry recording to an empty track.

```
ERROR : Memory full
                Push [ENTER]
```

User memory has become full. Save necessary user data to the memory card and clear unnecessary data to release the memory.

```
ERROR : Card is write protected
                Push [ENTER]
```

This message will be shown if you attempt saving onto a write-protected memory card. Cancel write-protection of the memory card and retry.

```
ERROR : Card read/write error
                Push [ENTER]
```

An error has occurred while the DTXTREM IIs was reading or writing a memory card. First re-format the memory card and retry. If the message still appears when you attempt reading writing on the re-formatted card, that memory card may be broken. Replace the memory card. In any case, the data stored on the troubled card may be corrupted.

```
ERROR : File is unknown format
                Push [ENTER]
```

The DTXTREM IIs cannot recognize the specified file (file format). Check if the file is suitable for the DTXTREM IIs and is not corrupted.

```
ERROR : Can't edit preset song
                Push [ENTER]
```

This message will be shown if you attempt to load a song from the memory card or by receiving bulk data when a preset song is selected (in Drum Kit Play mode). First select a user song and then retry loading a song.

```
ERROR : Can't edit card song
                Push [ENTER]
```

This message will be shown if you attempt to load a song from the memory card or by receiving bulk data when a card song is selected (in Drum Kit Play mode). First select a card song and then retry loading a song.

```
ERROR : Can't play SMF Type1
                Push [ENTER]
```

You attempted loading a MIDI file created in the SMF Type 1 format. Load the MIDI file after saving as a Type 0 file using an external sequencer.

```
ERROR : Volume is not empty
                Push [ENTER]
```

You attempted to delete a volume (directory) that contains a file. First delete all files in the volume, then delete it.

```
ERROR : File already exists
                Push [ENTER]
```

You attempted to rename a file with a duplicate name. Specify a unique file name

# Specifications

---

## Tone Generator

16-bit AWM2 (PCM)

## Wave Memory

DRAM: 16M bit x 4 (max 94 sec@44.1kHz)

## Polyphony

Maximum of 64 notes

## Multitimbres

16 parts

## Voices

Drum and Percussion: 2,174 voices

GM Melody: 128 voices (GM Level 1)

## System Effects

2 Blocks (Reverb, Chorus)

## Effects for Drumkit

2 Insertion Effects

## Sequencer

2 Tracks MIDI Sequencer

## Modes

### ■ 8 modes

- Drumkit Play mode
- Drumkit Trigger Edit mode
- Drumkit Voice Edit mode
- Drumkit Effect Edit mode
- Chain Play mode
- Song Job mode
- Utility mode
- Store mode

## Controllers

### ■ Push Switches x 23

PAGE ▲, PAGE ▼, RHYTHM/INS, BASS/DEL, OTHERS, CLICK, TOP, REW, PLAY/STOP, FF, REC, PLAY, CHAIN, SONG JOB, UTILITY, EXIT/NO, SHIFT, TRIGGER, VOICE, EFFECT, STORE, ENTER/YES, AUDITION

### ■ Slide Volumes x 10

MAIN OUT, PHONES, CLICK, ACCOMP/REVERB, SNARE, KICK, TOM, HI-HAT, CYMBAL, MISC

### ■ Rotary Encoders x 5

## Display

- 40 x 2 Characters Backlit LCD
- 3 digits 7 segments LED
- 14 Operation LEDs

## Memory Card

SmartMedia™ 3.3V Card used only

## Connectors

### ■ Rear Panel

- MIDI IN/OUT/THRU
- USB Connector
- FOOT SW (mono phone) — FC4, FC5, HH series
- HI-HAT CONTROL (stereo phone) — HH/RHH series hi-hat controllers
- OUTPUT L/MONO (mono phone)
- OUTPUT R (mono phone)
- DIGITAL OUT (EIAJ cp1201, IEC60958, S/P DIF)
- INDIVIDUAL OUTPUT 1 - 6 (mono phone)
- Trigger Input 1 - 8 (stereo phone — L: trigger, R: sw)
- Trigger Input 9/10, 11/12, 13/14, 15/16 (stereo phone — L, R: trigger)
- INPUT ATTENUATION switch 1 - 16 (DIP SW)

### ■ Side Panel

- Card Slot for Memory Card (SmartMedia™)

### ■ Front Panel

- PHONES (stereo phone)
- AUX IN (Stereo phone)
- AUX IN VOL

## Power Requirements

DC 12V

## Dimensions (W x D x H)

300mm x 229mm x 71mm

## Weight

2.2kg

## Included Accessories

- AC Power Adaptor (PA-5C or PA-5D)
- Owner's Manual
- Data List
- DXTREME IIs Installation Guide
- Warranty card
- CD-ROM (USB-MIDI driver)

Specifications and descriptions in this product brochure are for information purposes only. YAMAHA Corp. reserves the right to change or modify products or specifications at any time without prior notice. Since specifications, equipment or options may not be the same in every region, please check with your YAMAHA dealer.

All trademarks and registered trademarks are property of their respective owners.



# Index

## Numerics

11to12 .....	47
9to10 .....	47

## A

ACCOMP slider .....	26
ACCOMP/REVERB slider .....	10
AcpSens .....	59
AltGrp .....	52
Angle .....	59
Attack .....	51
Audio Connections .....	17
Audition button .....	11
AUX IN jack .....	10
AUX IN VOL control .....	10
AuxIn .....	75

## B

Balance .....	50
BankMSB & BankLSB .....	54, 72
BASS/DEL button .....	10, 25
BEAT .....	23
Beat .....	70
Buffer .....	35
Bulk Data	
Receiving .....	78
Sending .....	78

## C

Cable hook .....	13
CARD slot .....	11
Ch .....	71
Ch= .....	54
Chain	
Creating .....	30
Editing .....	30
Playing .....	32
Procedure, Creating or Editing .....	31
Procedure, Playing .....	32
Switching Display .....	30
CHAIN button .....	11
Chain Edit screen .....	30
Chain Name .....	30
Chain Play screen .....	32
CHAIN= .....	32
Channel .....	42
Channel Aftertouch .....	64
Chord Name	
Using .....	42
Chorus .....	55, 58
ChoSend .....	53, 54, 57, 72
Clear Track .....	68
CLICK .....	23
Click Basics .....	81
CLICK button .....	10
Click Playback .....	24
CLICK slider .....	10, 26
Click Voice .....	81
COMMON1 .....	47
COMMON2 .....	47

Connecting to a Power Source .....	19
Control Change .....	64
Copy from .....	69
Copy from Song/Track .....	68
Copy Measure .....	69
Copy to Track .....	69
Copy Track .....	68
Create .....	70
Create (volume) .....	87
Create Measure .....	70
Creating a Volume .....	87
Ctrl# & Value .....	54
Cursor .....	63
Curve .....	37, 44
CYMBAL slider .....	11, 26

## D

Data Area .....	63
Data Backup .....	90
Data entry knob .....	11
DC IN jack .....	13
Decay .....	51
Delete .....	88
Delete (data file) .....	88
Delete Measure .....	70
Deleting a Data File .....	88
Deleting a Sample .....	84
Dev.No .....	79
DIGITAL OUTPUT jack .....	13
Directory Structure .....	86
Displays .....	10
Dist .....	59
DrSens .....	59
Drum Kit Name .....	47
Drum Kit, current	
Copying from .....	44
Drum System .....	33
Drum Trigger .....	14
Attaching .....	15
DumpIntrvl .....	79

## E

Editing a Sample .....	84
Editing step .....	84
Effect .....	57
Effect Basics .....	57
EFFECT button .....	11
Effect Settings .....	55
4 Completely Separate Effects .....	56
Parallel Outputs with Effects .....	56
Sound Mixing .....	55
Empty .....	63
End .....	84
ENTER/YES button .....	11
Envelope .....	51
EQ .....	74
Erase Measure .....	71
EXIT/NO button .....	11
External MIDI Keyboard	
Using .....	43

Extra Snare Drum	
Setting .....	50

## F

Factory Set .....	77
Restoring .....	77
FCoffset .....	77
FCspt .....	77
FileName .....	87, 88
Filter .....	50, 72
FOOT SW jack .....	13
Foot Switch Function .....	46
FootCtrl1 .....	45
FootCtrl2 .....	45
FootSw1 .....	46
FootSw2 .....	46
Format (Memory Card) .....	85
Forward button .....	10
Free Memory .....	61
FreeMemory .....	83
FromFile .....	89
Func .....	39, 45, 46
FX= .....	58

## G

Gain .....	37
GateTime .....	42
Groove Check .....	29

## H

HH Controller Function .....	45
HHInput .....	45
High Freq .....	74
High Gain .....	74
HI-HAT CONTROL jack .....	13
Hi-hat Controller .....	14
HI-HAT slider .....	11, 26
HRTF (Head Related Transfer Function) .....	59

## I

IncFunc, DecFunc .....	77
INDIVIDUAL OUTPUT 1 - 6 jacks .....	13
Individual Output levels	
Adjusting .....	27
IndivOut .....	75
INPUT ATTENUATION switches .....	12
Input= .....	37, 39, 40, 41, 43
(from) Input .....	44
(to) Input .....	44
Insertion Effects .....	58
Insertion Effects 1/2 .....	55
InsFX .....	58

## J

JumpRecnt .....	76
-----------------	----

<b>K</b>			
Key On Mode	40		
KeyMode	51		
KICK slider	11, 26		
KIT	23		
Kit Common Settings	47		
KitName	47		
(to) Kit	44, 53		
<b>L</b>			
Layer	50		
LCDcont	76		
Learn	76		
LEDdisp	76		
Level	38		
Load	88		
Load (data file)	88		
Load operation	88		
Local	80		
Localizer	55, 57, 58		
Loclizr	58		
Low Freq	74		
Low Gain	74		
LpStart	84		
<b>M</b>			
MAIN OUT slider	10, 26		
MasterTune	75		
MeasLen	61		
Measure	69, 70		
Copy operation	69		
Delete operation	70		
Erase operation	71		
Insert operation	70		
Measure (from)	69, 70, 71		
Measure (to)	69, 70, 71		
Measure/Beat/Clock	63		
Memory	35		
Memory Card			
About	90		
Capacity	90		
Compatible type	90		
Creating a Volume	87		
Data Backup	90		
Deleting a Data File	88		
Directory Structure	86		
Format operation	85		
Formatting	85		
Handling	90		
Inserting	90		
Loading a Data File	88		
Naming Rule	87		
Removing	90		
Renaming a Data File	89		
Saving a Data File	87		
Stored Data Type	86		
Merge	79		
Mid Freq	74		
Mid Gain	74		
MIDI	44, 45, 46		
MIDI Bulk Dump	78		
MIDI Connections	18		
MIDI Envelope Generator	44		
MIDI Event			
Adding	63		
Changing	63		
Deleting	63		
Entering	63		
MIDI I/O	79		
MIDI IN/OUT/THRU terminals	12		
MIDI Receive	80		
MIDI Send	80		
MIDI Setup	54		
MIDI1	54		
MIDI2	54		
MIDI3	54		
MIDICtl	82		
MIDIEG	44		
MIDImode	79		
MIDIOut	81		
MISC slider	11, 26		
Mix operation	68		
Mix Track	68		
Mode	40, 81		
Move (sample file)	89		
Move Operation	89		
MoveWave / FromFile	89		
Moving a Sample File	89		
<b>N</b>			
Name	67		
Naming Rule	87		
Note	41, 43		
Note Number & Name	49, 50, 51, 53		
Note Numbers			
Setting	42		
Note Off			
Using with Looped Voices	52		
Note On	64		
Note On Event	41		
Note#	42		
(from) Note	53		
(to) Note	53		
Num=	31		
<b>O</b>			
OffValue	46		
Operations			
Basic	20		
OTHERS button	10, 25		
Output	53, 81		
OUTPUT L/MONO, R jacks	13		
Output Routing	53		
<b>P</b>			
Pad Song			
Setting	40		
PadCtl	37		
Pad-to-Input Matching Chart	16		
Page buttons	10		
Pan	50, 54, 72		
Parallel Outputs with Effects	56		
Part Setup	71		
PC	80		
PC#	54, 72		
PC10	80		
Peripherals	17		
PHONES jack	10		
PHONES slider	10, 26		
Pitch Bend	64		
PLAY button	11		
Playback Controls	24		
Playback Method	24		
Playback Part	25		
PlayCount	82		
Polyphonic Key Pressure	65		
Polyphony	51		
Power Source			
Connecting to	19		
Power-On Sequence	19		
Program Change	64		
<b>Q</b>			
Q	50		
Quantize	61		
Resolution	62		
Quantize operation	67		
Quantize Track	67		
<b>R</b>			
Real Head Pad	14		
Real-time Recording	62		
RecCount	82		
Receive10	80		
Record button	10		
Recording mode	61		
Recording operations	62		
Rej	39		
Rejection	39		
Rename	89		
Rename (data file)	89		
Rename operation	89		
Renaming a Data File	89		
Repeat	40, 67		
Reset button	10		
Resolution and Quantize	62		
Restoring Factory Set	77		
RevBypas	75		
Reverb	55, 57		
Reverb Effect			
Adjusting	27		
RevSend	53, 54, 57, 72		
Rewind button	10		
RHYTHM/INS button	10, 25		
RimVel	41		
Rotation	59		
Rubber Pad	14		
RvKeyOff	52		
RvKeyOn	52		
<b>S</b>			
Sample			
Deleting	84		
Editing	84		
Recording	83		
Sample File			
Moving	89		
Sampling Feature	82		
Sampling Setup	83		
Save	87		
Naming Rule	87		
Save (data file)	87		
Save operation	87		
Saving a Data File	87		
SelfRej	39		
SendHH	80		
Sens	45		
Sequencer	82		
SHIFT button	10, 27		
Side Panel	11		
Slider	75		

Slider Control .....	26
SNARE slider .....	11, 26
SONG .....	23
Song .....	40, 47
About .....	25
Clear operation .....	66
Copy operation .....	66
Song Clear .....	66
Song Copy .....	66
Song Job .....	65
Basic operations .....	65
Edit pages .....	65
SONG JOB button .....	11
Song Playback .....	24
Song Recording .....	60
Preparation .....	60
Real-time Recording .....	62
Step Recording .....	63
Song Set .....	67
Song Settings .....	24
Song1 .....	66
Song2 .....	66
Song3 .....	67
Song4 .....	67
Song5 .....	68
Song6 .....	68
Song7 .....	68
Song8 .....	69
Song9 .....	70
Song10 .....	70
Song11 .....	71
Song12 .....	71
Song13 .....	71
Song14 .....	71
Sound Mixing that Fully Utilizes Effects .....	55
Source .....	83
Spec Rej .....	39
STANDBY/ON switch .....	13
Start .....	84
Start/Stop button .....	10
Step .....	30
Step Recording .....	63
Available MIDI events .....	64
Step= .....	32
STORE button .....	11
Store Operation .....	35
Stored Data Type .....	86
SwapL/R .....	75
SyncMode .....	82
SysEx .....	80
System Chorus Effect .....	58
System Reverb Effect .....	57
System Trigger .....	76
System Utility .....	76
<b>T</b> .....	
Tap Tempo .....	28
TEMPO .....	23
Tempo .....	47, 67
Tempo Change .....	65
Time .....	44
to Track .....	68
ToFile .....	89
TOM slider .....	11, 26
Tone .....	50
Tone Generator .....	75
ToVolume .....	89
Track .....	61, 67, 68, 69, 70, 71
Clear operation .....	68
Copy operation .....	68
Mix operation .....	68
Quantize operation .....	67
TRACK 1 & TRACK 2 .....	24
Transmit .....	54, 71
Transmit Bulk Data .....	78
Transport Control .....	24
TrgAltG .....	41
TrgByps .....	76
TrgCopy1 .....	44
TrgCopy2 .....	44
TrgFunc .....	39
TrgLevel .....	83
TrgLink .....	76
TrgMIDI1 .....	40
TrgMIDI2 .....	41
TrgMIDI3 .....	43
TrgSens .....	37
TrgSens2 .....	37
TrgSens3 .....	39
TrgSet .....	77
Trigger Basics .....	37
TRIGGER button .....	11
Trigger Connections .....	16
Trigger Copy .....	44
Trigger Function .....	39
Trigger Input .....	
Copying from .....	44
Trigger Input to Sound Output .....	33
Trigger Inputs .....	12
Matching with Connected Pads .....	21
Trigger Level and Velocity, relationship .....	38
Trigger Settings .....	36
Basic operations .....	36
Copy operation .....	44
Edit pages .....	36
Tuning .....	49, 81
Two-track Sequencer .....	
2-Track Structure .....	60
Features .....	60
MIDI I/O to External Device .....	60
Three Recording Modes .....	60
Using Preset songs .....	60
Type .....	31, 37, 44, 45, 46, 49, 57, 58, 59, 81
<b>U</b> .....	
USB port .....	12
UseTempo .....	82
UT 1 .....	74
UT 2 .....	74
UT 3 .....	75
UT 4 .....	75
UT 5 .....	76
UT 6 .....	76
UT 7 .....	76
UT 8 .....	77
UT 9 .....	78
UT 10 .....	79
UT 11 .....	80
UT 12 .....	80
UT 13 .....	81
UT 14 .....	81
UT 15 .....	81
UT 16 .....	81
UT 17 .....	82
UT 18 .....	82
UT 19 .....	84
UT 20 .....	83
UT 21 .....	84
UT 22 .....	85, 88
UT 23 .....	87
UT 24 .....	88
UT 25 .....	89
UT 26 .....	89
UT 27 .....	87
Utility .....	73
Basic operations .....	73
Edit pages .....	73
UTILITY button .....	11
<b>V</b> .....	
Value .....	67
Velocity .....	38, 46
Velocity Crossfade .....	43
VelXFade .....	43
Voice .....	49
Copy operation .....	53
Voice (High/Mid/Low) .....	81
Voice Basics .....	49
VOICE button .....	11
Voice Copy .....	53
Voice Settings .....	48
Basic operations .....	48
Edit pages .....	48
Voice1 .....	49
Voice3 .....	50
Voice4 .....	51
Voice5 .....	51
Voice6 .....	53
VoiceCopy .....	53
VoiceSet .....	81
Vol .....	75, 81
Volume .....	47, 49, 54, 72, 87, 88, 89
Volume Balance .....	
Adjusting .....	26
VolumeName .....	87
<b>W</b> .....	
Wave1 .....	50
Wave2 .....	50
WaveDir .....	47
<b>X</b> .....	
XSdecay .....	50
XSfilter .....	50

For details of products, please contact your nearest Yamaha or the authorized distributor listed below.

Pour plus de détails sur les produits, veuillez-vous adresser à Yamaha ou au distributeur le plus proche de vous figurant dans la liste suivante.

Die Einzelheiten zu Produkten sind bei Ihrer unten aufgeführten Niederlassung und bei Yamaha Vertragshändlern in den jeweiligen Bestimmungsländern erhältlich.

Para detalles sobre productos, contacte su tienda Yamaha más cercana o el distribuidor autorizado que se lista debajo.

Per dettagli concernenti i prodotti, si prega di contattare il vostro rappresentante Yamaha più vicino o il distributore autorizzato indicato sotto.

Neem voor meer productinformatie contact op met uw dichtstbijzijnde Yamaha-dealer of de onderstaande officiële distributeur.

## NORTH AMERICA

### CANADA

**Yamaha Canada Music Ltd.**  
135 Milner Avenue, Scarborough, Ontario,  
M1S 3R1, Canada  
Tel: 416-298-1311

### U.S.A.

**Yamaha Corporation of America**  
6600 Orangethorpe Ave., Buena Park, Calif. 90620,  
U.S.A.  
Tel: 714-522-9011

## CENTRAL & SOUTH AMERICA

### MEXICO

**Yamaha de Mexico S.A. De C.V.,**  
Departamento de ventas  
Javier Rojo Gomez No.1149, Col. Gpe Del  
Moral, Deleg. Iztapalapa, 09300 Mexico, D.F.  
Tel: 55-5804-0600

### BRAZIL

**Yamaha Musical do Brasil LTDA.**  
Av. Rebouças 2636, São Paulo, Brasil  
Tel: 011-3085-1377

### ARGENTINA

**Yamaha Music Latin America, S.A.**  
Sucursal de Argentina  
Viamonte 1145 Piso2-B 1053,  
Buenos Aires, Argentina  
Tel: 1-4371-7021

### PANAMA AND OTHER LATIN AMERICAN COUNTRIES/ CARIBBEAN COUNTRIES

**Yamaha Music Latin America, S.A.**  
Torre Banco General, Piso 7, Urbanización Marbella,  
Calle 47 y Aquilino de la Guardia,  
Ciudad de Panamá, Panamá  
Tel: +507-269-5311

## EUROPE

### THE UNITED KINGDOM

**Yamaha-Kemble Music (U.K.) Ltd.**  
Sherbourne Drive, Tilbrook, Milton Keynes,  
MK7 8BL, England  
Tel: 01908-366700

### IRELAND

**Danfay Ltd.**  
61D, Sallynoggin Road, Dun Laoghaire, Co. Dublin  
Tel: 01-2859177

### GERMANY

**Yamaha Music Central Europe GmbH**  
Siemensstraße 22-34, 25462 Rellingen, Germany  
Tel: 04101-3030

### SWITZERLAND/LIECHTENSTEIN

**Yamaha Music Central Europe GmbH,**  
Branch Switzerland  
Seefeldstrasse 94, 8008 Zürich, Switzerland  
Tel: 01-383 3990

### AUSTRIA

**Yamaha Music Central Europe GmbH,**  
Branch Austria  
Schleiergasse 20, A-1100 Wien, Austria  
Tel: 01-60203900

### THE NETHERLANDS

**Yamaha Music Central Europe,**  
Branch Nederland  
Clarissenhof 5-b, 4133 AB Vianen, The Netherlands  
Tel: 0347-358 040

### BELGIUM/LUXEMBOURG

**Yamaha Music Central Europe GmbH,**  
Branch Belgium  
Rue de Geneve (Genevastraat) 10, 1140 - Brussels,  
Belgium  
Tel: 02-726 6032

### FRANCE

**Yamaha Musique France**  
BP 70-77312 Marne-la-Vallée Cedex 2, France  
Tel: 01-64-61-4000

### ITALY

**Yamaha Musica Italia S.P.A.**  
Combo Division  
Viale Italia 88, 20020 Lainate (Milano), Italy  
Tel: 02-935-771

### SPAIN/PORTUGAL

**Yamaha-Hazen Música, S.A.**  
Ctra. de la Coruna km. 17, 200, 28230  
Las Rozas (Madrid), Spain  
Tel: 91-639-8888

### GREECE

**Philippos Nakas S.A. The Music House**  
147 Skiathou Street, 112-55 Athens, Greece  
Tel: 01-228 2160

### SWEDEN

**Yamaha Scandinavia AB**  
J. A. Wettergrens Gata 1  
Box 30053  
S-400 43 Göteborg, Sweden  
Tel: 031 89 34 00

### DENMARK

**YS Copenhagen Liaison Office**  
Generatorvej 8B  
DK-2730 Herlev, Denmark  
Tel: 44 92 49 00

### FINLAND

**F-Musiikki Oy**  
Kluuvikatu 6, P.O. Box 260,  
SF-00101 Helsinki, Finland  
Tel: 09 618511

### NORWAY

**Norsk filial av Yamaha Scandinavia AB**  
Grini Næringspark 1  
N-1345 Østerås, Norway  
Tel: 67 16 77 70

### ICELAND

**Skifan HF**  
Skeifan 17 P.O. Box 8120  
IS-128 Reykjavik, Iceland  
Tel: 525 5000

### OTHER EUROPEAN COUNTRIES

**Yamaha Music Central Europe GmbH**  
Siemensstraße 22-34, 25462 Rellingen, Germany  
Tel: +49-4101-3030

## AFRICA

**Yamaha Corporation,**  
Asia-Pacific Music Marketing Group  
Nakazawa-cho 10-1, Hamamatsu, Japan 430-8650  
Tel: +81-53-460-2312

## MIDDLE EAST

### TURKEY/CYPRUS

**Yamaha Music Central Europe GmbH**  
Siemensstraße 22-34, 25462 Rellingen, Germany  
Tel: 04101-3030

### OTHER COUNTRIES

**Yamaha Music Gulf FZE**  
LB21-128 Jebel Ali Freezone  
P.O.Box 17328, Dubai, U.A.E.  
Tel: +971-4-881-5868

## ASIA

### THE PEOPLE'S REPUBLIC OF CHINA

**Yamaha Music & Electronics (China) Co.,Ltd.**  
25/F., United Plaza, 1468 Nanjing Road (West),  
Jingan, Shanghai, China  
Tel: 021-6247-2211

### HONG KONG

**Tom Lee Music Co., Ltd.**  
11/F., Silvercord Tower 1, 30 Canton Road,  
Tsimshatsui, Kowloon, Hong Kong  
Tel: 2737-7688

### INDONESIA

**PT. Yamaha Music Indonesia (Distributor)**  
**PT. Nusantara**  
Gedung Yamaha Music Center, Jalan Jend. Gatot  
Subroto Kav. 4, Jakarta 12930, Indonesia  
Tel: 21-520-2577

### KOREA

**Yamaha Music Korea Ltd.**  
Tong-Yang Securities Bldg. 16F 23-8 Yoido-dong,  
Youngdungpo-ku, Seoul, Korea  
Tel: 02-3770-0660

### MALAYSIA

**Yamaha Music Malaysia, Sdn., Bhd.**  
Lot 8, Jalan Perbandaran, 47301 Kelana Jaya,  
Petaling Jaya, Selangor, Malaysia  
Tel: 3-78030900

### PHILIPPINES

**Yupangco Music Corporation**  
339 Gil J. Puyat Avenue, P.O. Box 885 MCPO,  
Makati, Metro Manila, Philippines  
Tel: 819-7551

### SINGAPORE

**Yamaha Music Asia Pte., Ltd.**  
No.11 Ubi Road 1, No.06-02,  
Meiban Industrial Building, Singapore  
Tel: 747-4374

### TAIWAN

**Yamaha KHS Music Co., Ltd.**  
3F, #6, Sec.2, Nan Jing E. Rd. Taipei.  
Taiwan 104, R.O.C.  
Tel: 02-2511-8688

### THAILAND

**Siam Music Yamaha Co., Ltd.**  
891/1 Siam Motors Building, 15-16 floor  
Rama 1 road, Wangmai, Pathumwan  
Bangkok 10330, Thailand  
Tel: 02-215-2626

### OTHER ASIAN COUNTRIES

**Yamaha Corporation,**  
Asia-Pacific Music Marketing Group  
Nakazawa-cho 10-1, Hamamatsu, Japan 430-8650  
Tel: +81-53-460-2317

## OCEANIA

### AUSTRALIA

**Yamaha Music Australia Pty. Ltd.**  
Level 1, 99 Queensbridge Street, Southbank,  
Victoria 3006, Australia  
Tel: 3-9693-5111

### NEW ZEALAND

**Music Houses of N.Z. Ltd.**  
146/148 Captain Springs Road, Te Papapa,  
Auckland, New Zealand  
Tel: 9-634-0099

### COUNTRIES AND TRUST TERRITORIES IN PACIFIC OCEAN

**Yamaha Corporation,**  
Asia-Pacific Music Marketing Group  
Nakazawa-cho 10-1, Hamamatsu, Japan 430-8650  
Tel: +81-53-460-2312

**HEAD OFFICE** Strings, Guitar & Percussion Division, Yamaha Corporation  
Nakazawa-cho 10-1, Hamamatsu, Japan 430-8650  
Tel: +81-53-460-2581

