



*GranTouch*TM

Digital Grand Piano

Owner's manual

Bedienungsanleitung

Manuel de l'utilisateur

Manual de instrucciones

Uso e manutenzione

使用者手冊

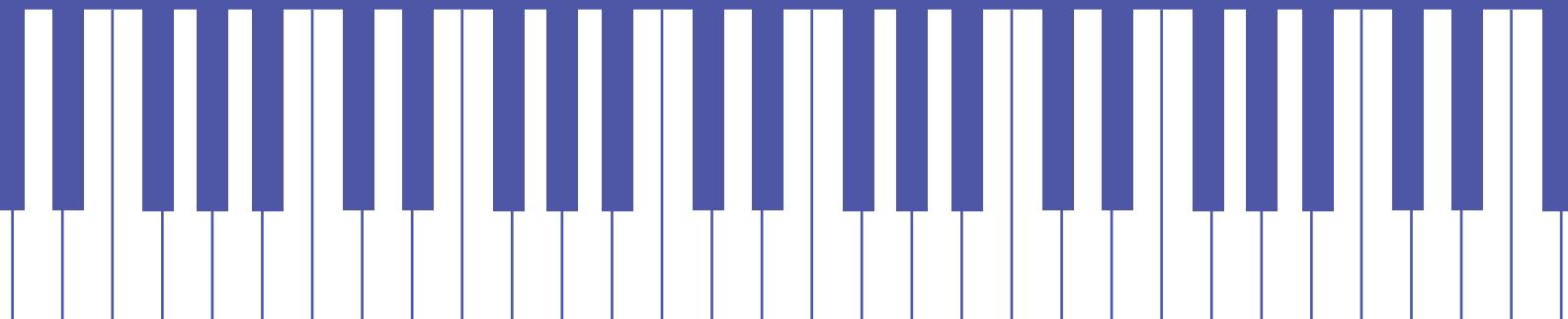

FCC INFORMATION (U.S.A.)

1. IMPORTANT NOTICE: DO NOT MODIFY THIS UNIT!

This product, when installed as indicated in the instructions contained in this manual, meets FCC requirements. Modifications not expressly approved by Yamaha may void your authority, granted by the FCC, to use the product.

2. IMPORTANT: When connecting this product to accessories and/or another product use only high quality shielded cables. Cable/s supplied with this product **MUST** be used. Follow all installation instructions. Failure to follow instructions could void your FCC authorization to use this product in the USA.

3. NOTE: This product has been tested and found to comply with the requirements listed in FCC Regulations, Part 15 for Class "B" digital devices. Compliance with these requirements provides a reasonable level of assurance that your use of this product in a residential environment will not result in harmful interference with other electronic devices. This equipment generates/uses radio frequencies and, if not installed and used according to the instructions found in the users manual, may cause interference harmful to the operation of other electronic devices. Compliance with FCC regulations does not guarantee that interference will not occur in all installations. If this product is found to be the source of interference, which can be determined by turning the unit "OFF" and "ON", please try to eliminate the problem by using one of the following measures:

Relocate either this product or the device that is being affected by the interference.

Utilize power outlets that are on different branch (circuit breaker or fuse) circuits or install AC line filter/s.

In the case of radio or TV interference, relocate/reorient the antenna. If the antenna lead-in is 300 ohm ribbon lead, change the lead-in to coaxial type cable.

If these corrective measures do not produce satisfactory results, please contact the local retailer authorized to distribute this type of product. If you can not locate the appropriate retailer, please contact Yamaha Corporation of America, Electronic Service Division, 6600 Orangethorpe Ave, Buena Park, CA 90620

The above statements apply **ONLY** to those products distributed by Yamaha Corporation of America or its subsidiaries.

IMPORTANT NOTICE FOR THE UNITED KINGDOM

Connecting the Plug and Cord

IMPORTANT: The wires in this mains lead are coloured in accordance with the following code:

BLUE : NEUTRAL

BROWN : LIVE

As the colours of the wires in the mains lead of this apparatus may not correspond with the coloured markings identifying the terminals in your plug proceed as follows:

The wire which is coloured **BLUE** must be connected to the terminal which is marked with the letter **N** or coloured **BLACK**.

The wire which is coloured **BROWN** must be connected to the terminal which is marked with the letter **L** or coloured **RED**.

Making sure that neither core is connected to the earth terminal of the three pin plug.

CANADA

CAUTION: TO PREVENT ELECTRIC SHOCK, MATCH WIDE BLADE OF PLUG TO WIDE SLOT, FULLY INSERT.

ATTENTION: POUR ÉVITER LES CHOCS ÉLECTRIQUES, INTRODUIRE LA LAME LA PLUS LARGE DE LA FICHE DANS LA BORNE CORRESPONDANTE DE LA PRISE ET POUSSER JUSQU'AU FOND.

SPECIAL MESSAGE SECTION

PRODUCT SAFETY MARKINGS: Yamaha electronic products may have either labels similar to the graphics shown below or molded/stamped facsimiles of these graphics on the enclosure. The explanation of these graphics appears on this page. Please observe all cautions indicated on this page and those indicated in the safety instruction section.

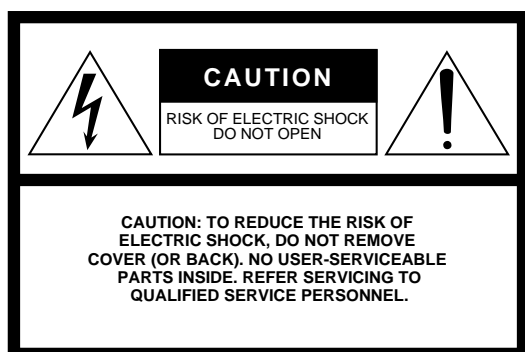

SEE BOTTOM OF ENCLOSURE FOR GRAPHIC SYMBOL MARKINGS



The exclamation point within the equilateral triangle is intended to alert the user to the presence of important operating and maintenance (servicing) instructions in the literature accompanying the product.

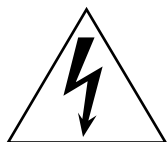

The lightning flash with arrowhead symbol within the equilateral triangle is intended to alert the user to the presence of uninsulated “dangerous voltage” within the product’s enclosure that may be of sufficient magnitude to constitute a risk of electrical shock.

IMPORTANT NOTICE: All Yamaha electronic products are tested and approved by an independent safety testing laboratory in order that you may be sure that when it is properly installed and used in its normal and customary manner, all foreseeable risks have been eliminated. DO NOT modify this unit or commission others to do so unless specifically authorized by Yamaha. Product performance and/or safety standards may be diminished. Claims filed under the expressed warranty may be denied if the unit is/has been modified. Implied warranties may also be affected.

SPECIFICATIONS SUBJECT CHANGE: The information contained in this manual is believed to be correct at the time of printing. However, Yamaha reserves the right to change or modify any of the specifications without notice or obligation to update existing units.

ENVIRONMENTAL ISSUES: Yamaha strives to produce products that are both user safe and environmentally friendly. We sincerely believe that our products and the production methods used to produce them, meet these goals. In keeping with both the letter and the spirit of the law, we want you to be aware of the following:

Disposal Notice: Should this product become damaged beyond repair, or for some reason its useful life is considered to be at an end, please observe all local, state, and federal regulations that relate to the disposal of products that contain lead, batteries, plastics, etc.

NOTICE: Service charges incurred due to lack of knowledge relating to how a function or effect works (when the unit is operating as designed) are not covered by the manufacturer’s warranty, and are therefore the owners responsibility. Please study this manual carefully and consult your dealer before requesting service.

NAME PLATE LOCATION: The graphic below indicates the location of the name plate. The model number, serial number, power requirements, etc., are located on this plate. You should record the model number, serial number, and the date of purchase in the spaces provided below and retain this manual as a permanent record of your purchase.

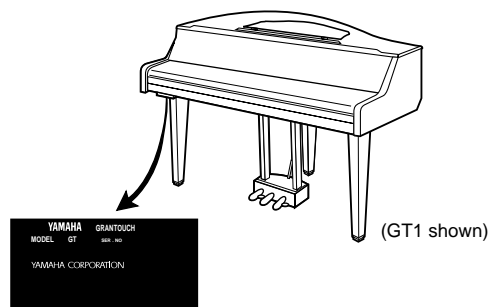

Model _____

Serial No. _____

Purchase Date _____

IMPORTANT SAFETY INSTRUCTIONS

INFORMATION RELATING TO PERSONAL INJURY, ELECTRICAL SHOCK,
AND FIRE HAZARD POSSIBILITIES HAS BEEN INCLUDED IN THIS LIST.

WARNING — When using any electrical or electronic product, basic precautions should always be followed. These precautions include, but are not limited to, the following:

1. Read all Safety Instructions, Installation Instructions, Special Message Section items, and any Assembly Instructions found in this manual BEFORE making any connections, including connection to the main supply.
2. Main Power Supply Verification: Yamaha products are manufactured specifically for the supply voltage in the area where they are to be sold. If you should move, or if any doubt exists about the supply voltage in your area, please contact your dealer for supply voltage verification and (if applicable) instructions. The required supply voltage is printed on the name plate. For name plate location, please refer to the graphic found in the Special Message Section of this manual.
3. This product may be equipped with a polarized plug (one blade wider than the other). If you are unable to insert the plug into the outlet, turn the plug over and try again. If the problem persists, contact an electrician to have the obsolete outlet replaced. DO NOT defeat the safety purpose of the plug.
4. Some electronic products utilize external power supplies or adapters. DO NOT connect this type of product to any power supply or adapter other than one described in the owners manual, on the name plate, or specifically recommended by Yamaha.
5. **WARNING:** Do not place this product or any other objects on the power cord or place it in a position where anyone could walk on, trip over, or roll anything over power or connecting cords of any kind. The use of an extension cord is not recommended! If you must use an extension cord, the minimum wire size for a 25' cord (or less) is 18 AWG. NOTE: The smaller the AWG number, the larger the current handling capacity. For longer extension cords, consult a local electrician.
6. Ventilation: Electronic products, unless specifically designed for enclosed installations, should be placed in locations that do not interfere with proper ventilation. If instructions for enclosed installations are not provided, it must be assumed that unobstructed ventilation is required.
7. Temperature considerations: Electronic products should be installed in locations that do not significantly contribute to their operating temperature. Placement of this product close to heat sources such as; radiators, heat registers and other devices that produce heat should be avoided.
8. This product was NOT designed for use in wet/damp locations and should not be used near water or exposed to rain. Examples of wet/damp locations are; near a swimming pool, spa, tub, sink, or wet basement.
9. This product should be used only with the components supplied or; a cart, rack, or stand that is recommended by the manufacturer. If a cart, rack, or stand is used, please observe all safety markings and instructions that accompany the accessory product.
10. The power supply cord (plug) should be disconnected from the outlet when electronic products are to be left unused for extended periods of time. Cords should also be disconnected when there is a high probability of lightening and/or electrical storm activity.
11. Care should be taken that objects do not fall and liquids are not spilled into the enclosure through any openings that may exist.
12. Electrical/electronic products should be serviced by a qualified service person when:
 - a. The power supply cord has been damaged; or
 - b. Objects have fallen, been inserted, or liquids have been spilled into the enclosure through openings; or
 - c. The product has been exposed to rain; or
 - d. The product does not operate, exhibits a marked change in performance; or
 - e. The product has been dropped, or the enclosure of the product has been damaged.
13. Do not attempt to service this product beyond that described in the user-maintenance instructions. All other servicing should be referred to qualified service personnel.
14. This product, either alone or in combination with an amplifier and headphones or speaker/s, may be capable of producing sound levels that could cause permanent hearing loss. DO NOT operate for a long period of time at a high volume level or at a level that is uncomfortable. If you experience any hearing loss or ringing in the ears, you should consult an audiologist. IMPORTANT: The louder the sound, the shorter the time period before damage occurs.
15. Some Yamaha products may have benches and/or accessory mounting fixtures that are either supplied as a part of the product or as optional accessories. Some of these items are designed to be dealer assembled or installed. Please make sure that benches are stable and any optional fixtures (where applicable) are well secured BEFORE using. Benches supplied by Yamaha are designed for seating only. No other uses are recommended.

PLEASE KEEP THIS MANUAL



*GranTouch*TM

Digital Grand Piano

Owner's Manual

Important

Read the Following Warnings and Cautions Before Operating the *GranTouch* Digital Grand Piano

Warnings

- Do not locate the *GranTouch* in a place subject to excessive heat, low temperatures, or direct sunlight. This could be a fire hazard and may damage the finish and internal parts.
- Do not place the *GranTouch* in a place subject to excessive humidity or dust. This could be a fire and electrical shock hazard.
- Connect the plug on the *GranTouch* power cable to a compatible AC outlet. Failure to do so is a fire and electrical shock hazard. If the power cable plug is not compatible with your AC outlet, consult your dealer.
- Do not plug several devices into the same AC outlet. This can overload the AC outlet, and can be a fire and electrical shock hazard. It may also affect the performance of some devices.
- Do not place heavy objects on the power cable. A damaged power cable is a potential fire and electrical shock hazard. If the power cable is hidden under a carpet, make sure heavy objects, including the *GranTouch*, are not placed on top of the cable.
- If the power cable is damaged (i.e. cut or a bare wire is exposed), ask your dealer for a replacement. Using the *GranTouch* in this condition is a fire and shock hazard.
- Hold the plug when disconnecting the power cable from an AC outlet. Never pull the cable. Damaging the cable in this way is a potential fire and electrical shock hazard.
- Do not place liquid containers such as vases, potted plants, glasses, cosmetic bottles, medicines, etc., on top of the *GranTouch*. This is a potential fire and electrical shock hazard.
- Do not block the ventilation holes in the *GranTouch*. The *GranTouch* has ventilation holes underneath to prevent the internal temperature from rising. Blocked ventilation holes are a fire hazard.
- Do not try to modify the *GranTouch*. This could be a fire and electrical shock hazard.
- When moving the *GranTouch* to another location, turn off the power, remove the power plug from the AC outlet, and remove all cables connected to external devices. Damaging cables in this way is a potential fire and electrical shock hazard.
- Be careful not to pinch your fingers when you close the keyboard cover. Use both hands to open and close the keyboard cover. Keep the keyboard cover closed when you are not using the *GranTouch*.

Cautions

- Turn off all audio devices and speakers when connecting to the *GranTouch*. Refer to the user's guide for each device. Use the correct cables and connect as specified.
- Set the volume level on all the devices to minimum before turning on. Extremely loud noises can damage your hearing.
- Do not play the *GranTouch* at a high volume level for a long time of period; you may damage your hearing. This is especially important when using headphones. If you think your hearing ability is impaired or your ears are ringing, consult an ear doctor.
- If you notice any abnormality—such as smoke, odor, or noise—turn off the *GranTouch* immediately. Remove the power plug from the AC outlet. Confirm that the abnormality is no longer present. Consult your dealer for repair. Using the *GranTouch* in this condition is a fire and shock hazard.
- If a foreign object or water gets inside the *GranTouch*, turn off the *GranTouch* immediately. Remove the power plug from the AC outlet. Consult your dealer for repair. Using the *GranTouch* in this condition is a fire and electrical shock hazard.
- If you plan not to use the *GranTouch* for a long period of time (such as when you are on vacation), remove the power plug from the AC outlet. Leaving the *GranTouch* connected is a fire hazard.
- Remove the power plug from the AC outlet before cleaning the *GranTouch*. Leaving the power plug connected is an electrical shock hazard.
- Do not use benzene, thinner, cleaning detergent, or a chemical cloth to clean the *GranTouch*.
- Do not place metal objects or objects with rubber feet on top of the *GranTouch*. The color and finish of the *GranTouch* can be damaged.
- Do not place heavy objects, or climb and sit on the *GranTouch*. Doing so can damage the *GranTouch*.
- Do not drag the *GranTouch*. Doing so can damage the *GranTouch* legs and the floor. When moving, always lift the *GranTouch* carefully.
- Use only a soft, dry cloth to clean the *GranTouch*. If you discover a stain, carefully use a soft damp cloth to remove it.

Interference

- The *GranTouch* uses high-frequency digital circuits that may cause interference on radios and TVs placed close to it. If interference does occur, relocate the affected equipment.

Please Keep This Manual For Future Reference

Table of Contents

Touring the <i>GranTouch</i> - - - - -	1
Playing the <i>GranTouch</i> - - - - -	4
Reverb - - - - -	5
Pitch - - - - -	6
Creative Options - - - - -	8
Playing the Demo Songs - - - - -	10
Troubleshooting - - - - -	11
Specifications - - - - -	12
MIDI Implementation Chart - - - - -	End of manual

Welcome to the *GranTouch*

Thank you for choosing a Yamaha *GranTouch*[™]—the digital piano with a “grand” touch and sound. The rest of this page talks about the *GranTouch*’s unique features.

Real Grand Piano Keyboard and Action

GranTouch is the first digital piano to feature a real grand piano keyboard and action, so it feels and responds just like a real grand piano. Newly developed continuous optical key sensors mean that the *GranTouch* captures every subtle nuance of your playing. Even staccato and legato playing is reproduced faithfully.

Real Grand Piano Sound

The superb piano sound is provided by a massive 30-megabyte memory, which contains the digitally sampled, stereo sound of a classic Yamaha CFIIS concert grand piano. Even the effect of the sustain pedal has been captured, providing the rich harmonic resonance of a true grand. A 60-watt stereo power amplifier and three-way speaker system reproduce the sound in all its richness and glory. While high-quality reverb programs simulate the acoustic ambiance of three different playing environments: Room, Hall 1, and Hall 2.

Play Anytime, Anywhere

A continuous volume control allows you to play at any volume, depending on your situation. For private practice without disturbing others, headphones can be used. Two pairs of headphones can be connected so another person can listen to your playing or play along in a duet. AUX and MIDI connections expand your creative options for using the *GranTouch* with other electronic musical instruments, computers, and MIDI sequencers.

Touring the *GranTouch*

This chapter takes you on a tour of the *GranTouch*, identifying the various parts to help you become familiar with your new instrument.

Overall View

GT1*, GT2

GT7

(*The GT1 does not feature an opening lid.)

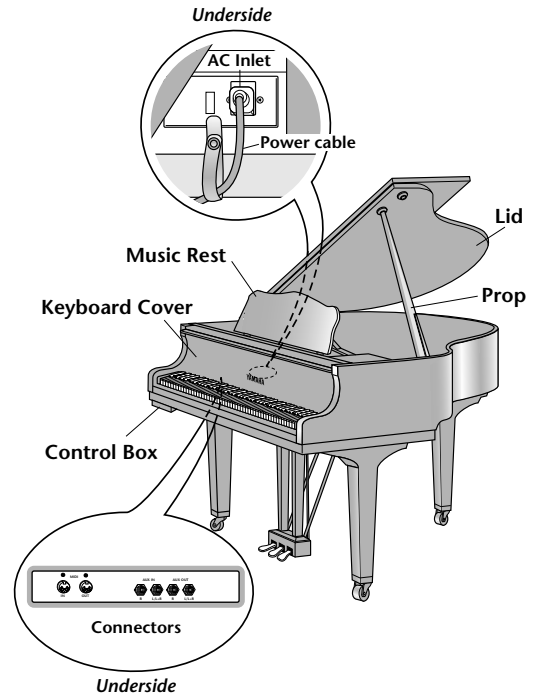
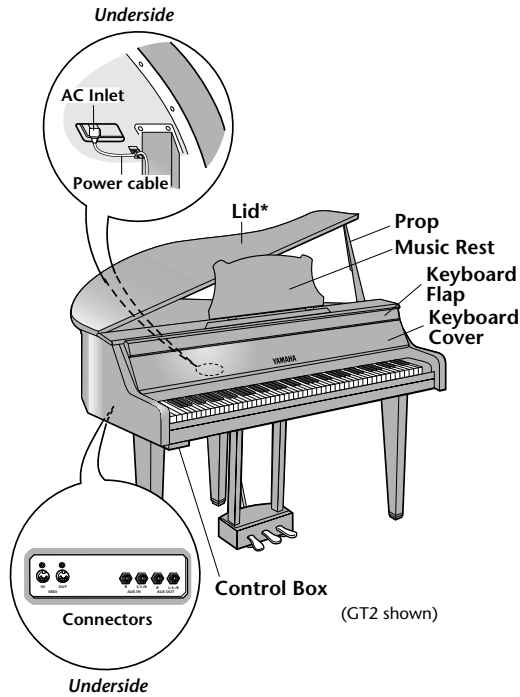

Control Box

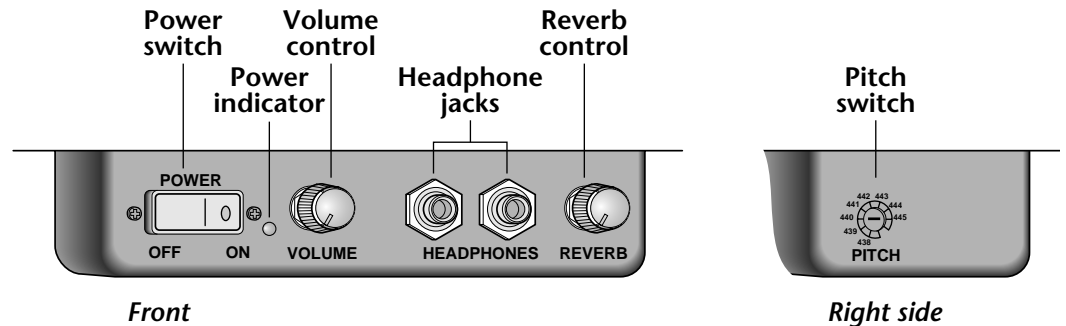

Underside Connectors

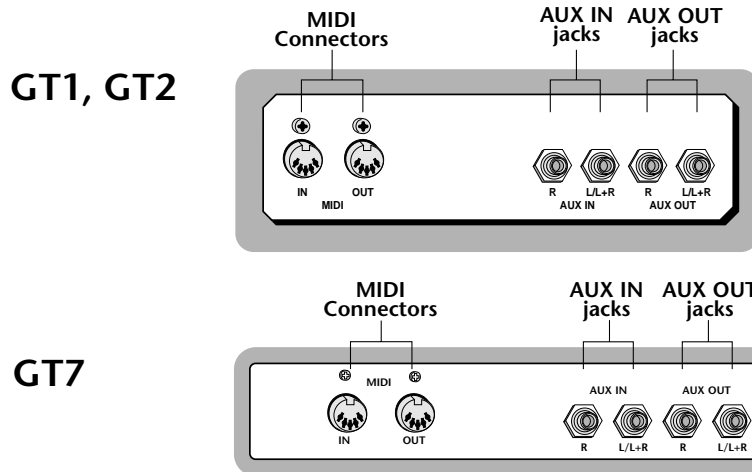

Pedals

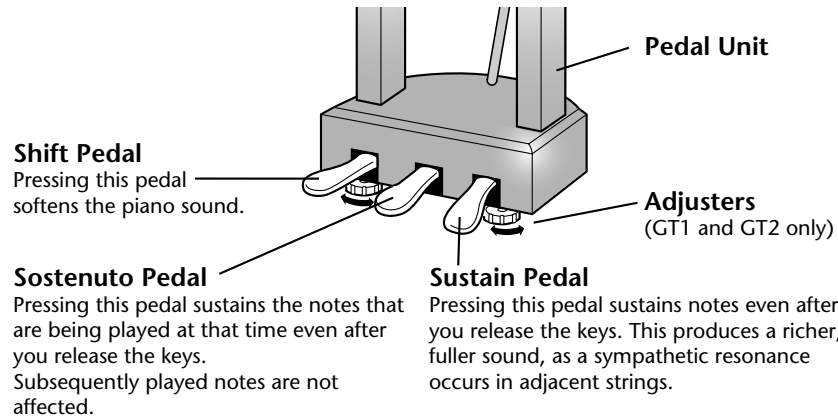

Setting the Pedal Unit Adjusters (GT1 and GT2 only)

There are two adjusters underneath the Pedal Unit. You must set them so that the Pedal Unit is firmly clamped between the *GranTouch* underside and the floor. The Pedal Unit should not move when the pedals are pressed.

Warning: Failure to set the Pedal Unit Adjusters correctly can damage the Pedal Unit.

Keyboard Cover (Fallboard)

Opening the Keyboard Cover

1. Using both hands, carefully raise the keyboard cover until it rests on the piano body.
2. Fold the keyboard flap down onto the fallboard (no flap on the GT7).

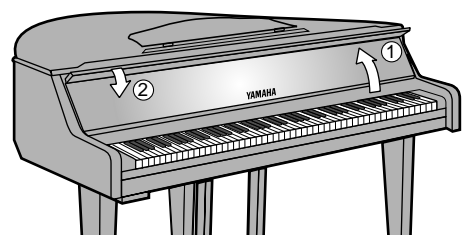

(GT1 shown)

Closing the Keyboard Cover

1. Fold up the keyboard flap (no flap on the GT7).
2. Using both hands, carefully close the keyboard cover.

Tip: To protect the keyboard when you're not playing, keep the keyboard cover closed.

Music Rest (GT1 and GT2 only*)

Setting the Music Rest

1. Carefully raise up the music rest.
2. Pull out the two supports at the bottom rear of the music rest.
3. Push the music rest back a little so that it rests on the supports.

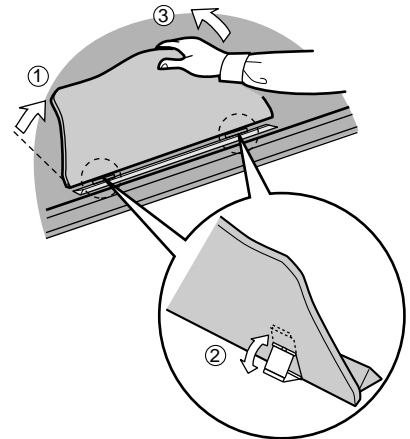

Putting Away the Music Rest

1. Pull the music rest forward a little.
2. Close the two supports at the rear of the music rest so that they sit flat.
3. Carefully lower the music rest.

* The GT7 features a standard grand piano music rest.

Lid (GT2 and GT7 only)

You can open the lid of the *GranTouch* in the same way as you would open the lid of a grand piano. Two props (long and short) are supplied. Use the longer prop to open the lid wider so that the sound will be much clearer. Make sure that the end of the prop is fitted in the inner cup. Use the shorter stick to make a smaller opening. In this case, fit the end of the prop in the outer cup as shown.

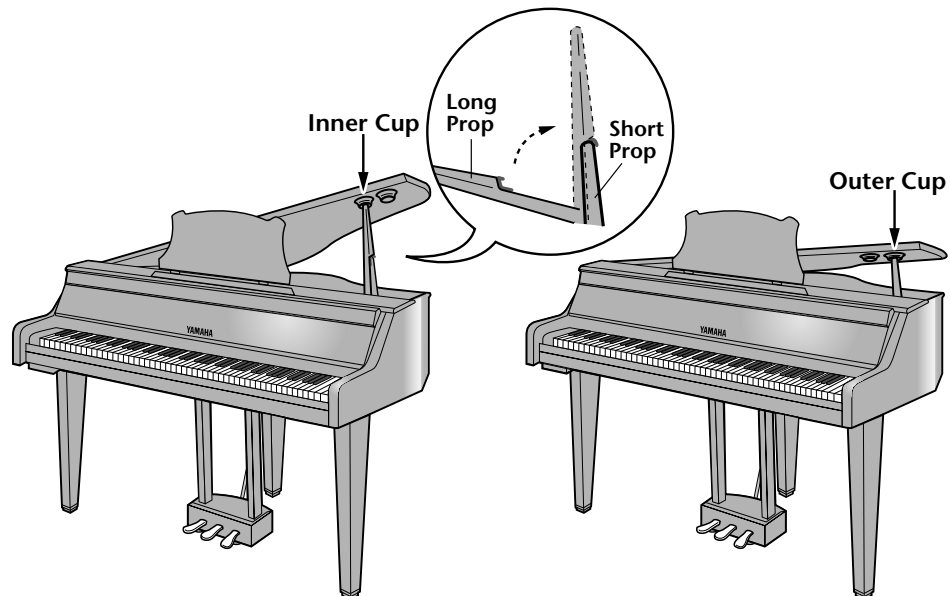

(GT2 shown)

Playing the *GranTouch*

Connecting the Power Cable

1. Make sure that the power cable is connected securely to the AC inlet socket on the underside of the *GranTouch*.
2. Plug the other end of the power cable into a suitable AC wall outlet.

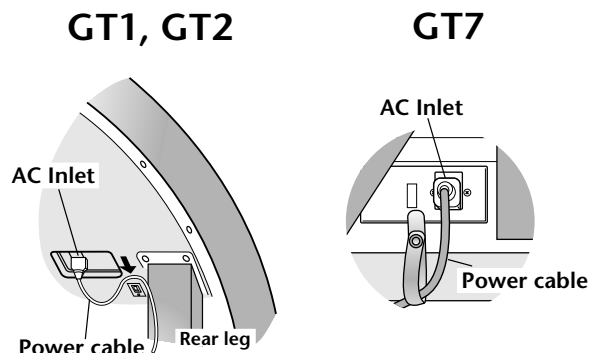

Powering Up the *GranTouch*

1. Press the ON side of the POWER switch. The power indicator lights up.

To power down the *GranTouch*, press the OFF side of the POWER switch.

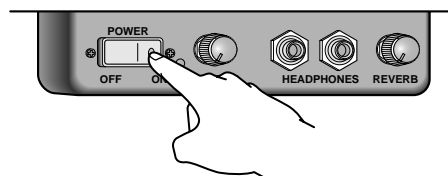

Setting the Volume

1. Use the VOLUME control on the Control Box to set the volume.



Using Headphones

1. Connect a pair of headphones to either one of the HEADPHONE jacks on the Control Box.
2. Use the VOLUME control on the Control Box to set the volume.

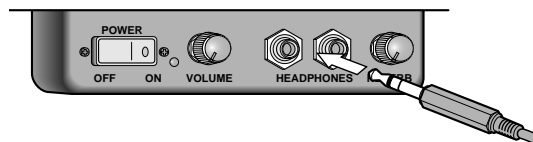

Note: Inserting a headphone plug into one of HEADPHONE jacks turns off the internal *GranTouch* speakers, so you can play in private without disturbing others.

Since two pairs of headphones can be connected to the Control Box, another person can listen to your playing or play along in a duet.

Optional Yamaha HPE-170 headphones are ideal for use with the *GranTouch*.

Reverb

The *GranTouch* features sophisticated reverberation effects, which enhance the digital piano by adding natural ambience to the sound.

Setting the Amount of Reverb

The amount of reverb applied to the piano sound is determined by the REVERB control on the Control Box. Turn the control clockwise to increase the reverb, counterclockwise to decrease it. Reverb is off when the REVERB control is turned fully counterclockwise.

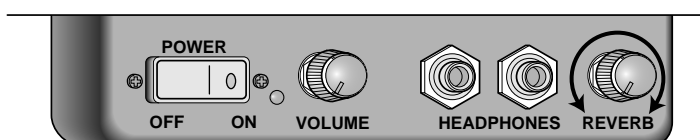

Setting the Type of Reverb

The *GranTouch* features three different reverb programs: **Room**, **Hall 1**, and **Hall 2**. You can select the reverb programs by holding down certain keys while powering up.

Tip: **Hall 1** is the default reverb program. It is selected even if you don't press any keys during power up.

1. To select a reverb program, hold down one of the keys shown in the following illustration while powering up the *GranTouch*.

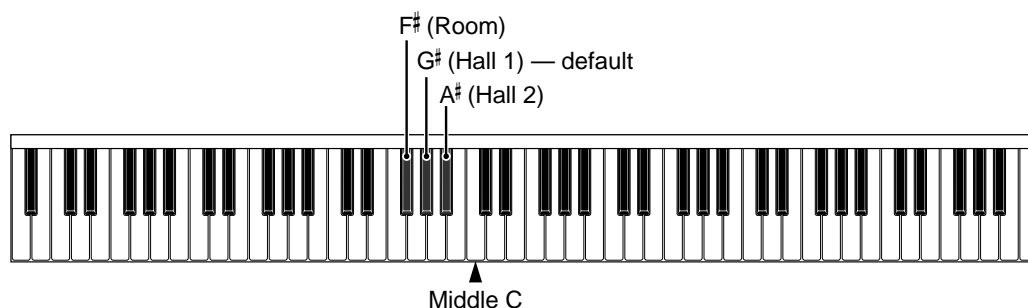

Note: You must hold the key down until a click is heard and then release it. Otherwise, the desired reverb program may not be selected.

Room: this reverb program simulates the reverb of a live room.

Hall 1: this reverb program simulates the reverb of a small concert hall.

Hall 2: this reverb program simulates the reverb of a large concert hall.

Note: When you power down the *GranTouch*, it does not remember which reverb program you used. Next time you use the *GranTouch*, reselect the desired reverb program.

Pitch

Initially the *GranTouch* is tuned to the standard Concert Pitch (A=440 hertz). You can, however, adjust the pitch to suit your particular application. Different pitches are sometimes used in vocal music and orchestral performances. The pitch can be adjusted in one hertz steps from 438 to 445 hertz (one hertz is about four cents).

Adjusting the Pitch

You'll need a small, flat-blade screwdriver to adjust the PITCH switch, which is located on the right side of the Control Box, as shown below.

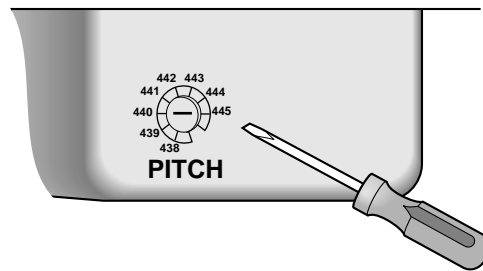

Note: The PITCH switch setting is remembered when the *GranTouch* is powered down.

Fine Tuning

As well as being able to tune the *GranTouch* in one hertz steps with the PITCH switch, you can also fine tune it using the keyboard. The *GranTouch* can be tuned up or down 50 cents, in 1.2 cent steps (100 cents equals one semitone). This allows you to achieve a perfect tuning match between the *GranTouch* and another instrument, a vocalist, or a slightly off-speed cassette player.

Note: Fine tuning settings are not remembered when the *GranTouch* is powered down.

Tuning Up

To finely tune up the *GranTouch*, hold down the A and B keys at the far left of the keyboard and press any one of the keys from middle C to B. It doesn't matter which key you press, just so long as it's in the middle C to B range, which is shown highlighted in the illustration below. The pitch is raised 1.2 cents for each key press.

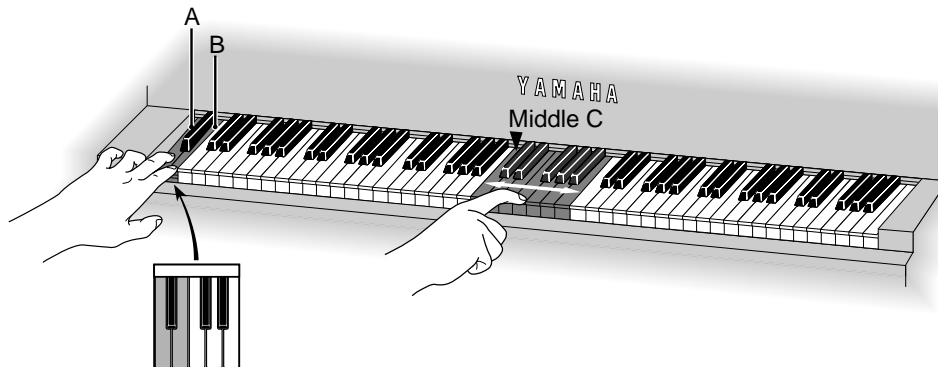

Tuning Down

To finely tune down the *GranTouch*, hold down the A and A[#] keys at the far left of the keyboard and press any one of the keys from middle C to B. It doesn't matter which key you press, just so long as it's in the middle C to B range, which is shown highlighted in the illustration below. The pitch is lowered 1.2 cents for each key press.

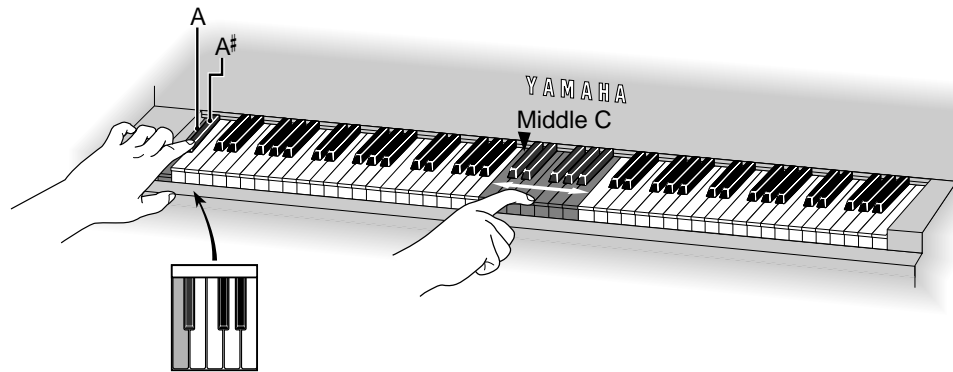

Resetting the Pitch

To reset the pitch of the *GranTouch*, hold down the A, A[#], and B keys at the far left of the keyboard and press any one of the keys from middle C to B. It doesn't matter which key you press, just so long as it's in the middle C to B range, which is shown highlighted in the illustration below. The pitch is reset to that specified by the PITCH switch.

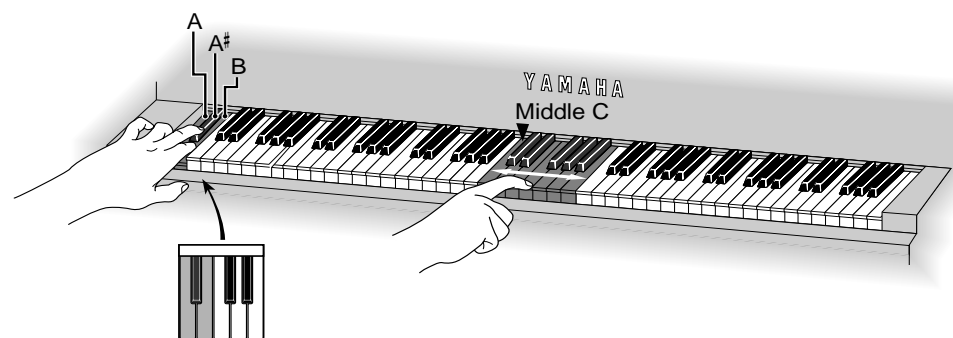

Creative Options

The *GranTouch*'s AUX and MIDI connectors expand your creative options. They are located underneath the *GranTouch*. See the illustrations on pages 1 and 2.

Recording (AUX OUT)

The AUX OUT connectors allow you to record your playing to a tape recorder. They can also be used to record your playing through an audio mixer in a recording studio, or to connect powered speakers. The following illustration shows how to make the connections.

The AUX OUT connectors are 1/4" phone jacks. You'll need adaptors to connect phono or mini-jack cables.

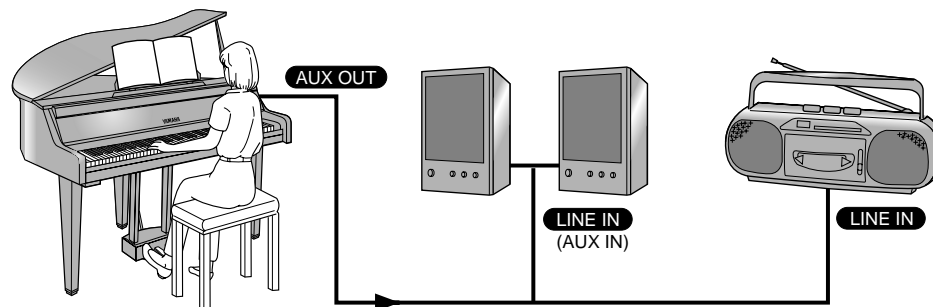

Note: If your tape recorder has only one input (mono), connect it to the "L/L+R" AUX OUT connector to achieve the best sound.

Note: If you connect your hi-fi to the AUX OUT connections for listening or recording, be aware that the *GranTouch* is capable of producing sounds with a wide dynamic range. On smaller systems you should keep the volume down to avoid speaker damage.

External Music Source (AUX IN)

The AUX IN connectors allow you to connect an external music source, such as a tape recorder or CD player, and play along with it through the *GranTouch* speakers or connected headphones. Use the volume control on the external music source to balance the volume with that of the *GranTouch*. The following illustration shows how to make the connections.

The AUX IN connectors are 1/4" phone jacks. You'll need adaptors to connect phono or mini-jack cables.

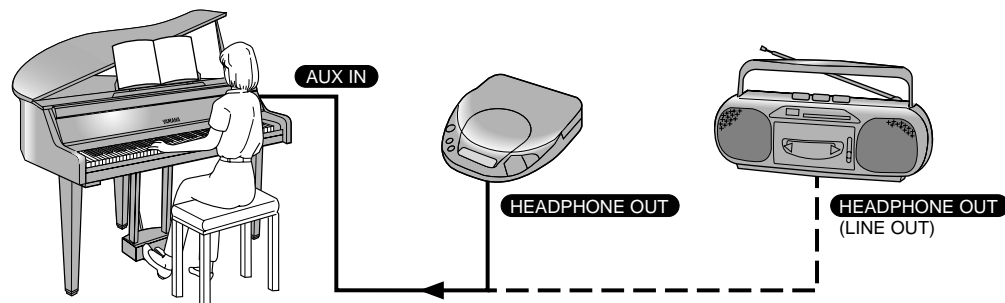

Note: If your music source has only one output (mono), connect it to the "L/L+R" AUX IN connector to achieve the best sound.

Playing Other MIDI Instruments (MIDI OUT)

MIDI is an acronym for Musical Instrument Digital Interface. It allows electronic musical instruments to communicate with each other. MIDI cables do not carry sound, they carry digital instructions. These instructions tell instruments which notes to play, when to play them, and at what volume. If you want to know more, check out the MIDI books at your local music dealers or bookstore.

The MIDI OUT connector allows you to play other electronic musical instruments from the *GranTouch* keyboard, or record your playing to a MIDI sequencer. The *GranTouch* transmits MIDI information on MIDI Channel 1. So you'll need to set the receiving device to MIDI Channel 1. The following illustration shows how to make the connections.

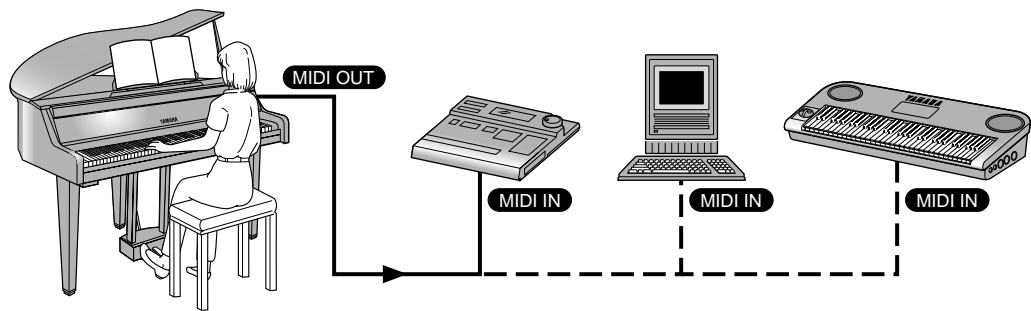

Sequencing (MIDI IN)

The MIDI IN connector allows you to play the *GranTouch* digital piano from another keyboard, or playback a performance you have recorded on a MIDI sequencer. The *GranTouch* receives MIDI information on MIDI Channel 1. So you'll need to set the transmitting device to MIDI Channel 1. The following illustration shows how to make the connections.

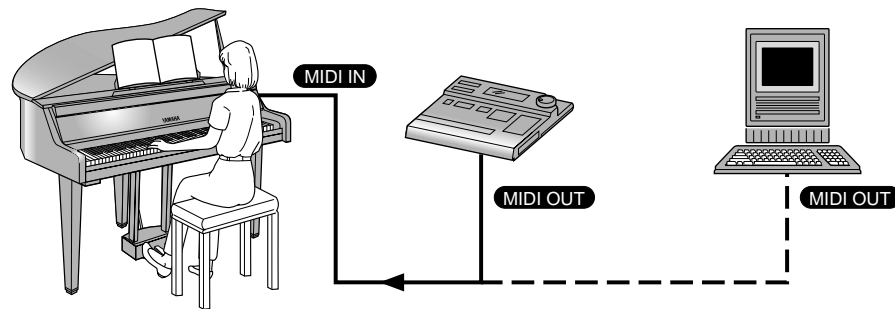

MIDI Note

The *GranTouch* transmits and receives note on and off, note velocity on and off, and key aftertouch information. Pedal information is carried via MIDI Controller messages.

Note: This function enables the *GranTouch* to transmit and receive the position of the keys as independent additional information, instead of continuously transmitting “key aftertouch” data based on key pressure applied after the keys are played.

Playing the Demo Songs

The *GranTouch* contains eight demo songs. To play the demo songs you must engage **Demo Song mode**. To do this, hold down the B and C keys at the far right of the keyboard while powering up the *GranTouch*.

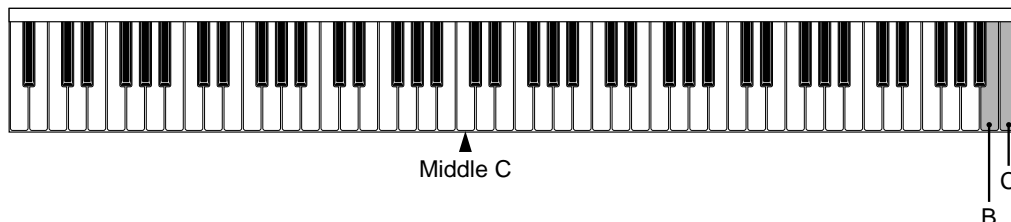

Note: You must hold down the B and C keys shown above until a click is heard and then release them. Otherwise, Demo Song mode may not be engaged.

The eight demo songs will start playing a few seconds after you release the keys and will play repeatedly until you stop them.

To stop demo song playback, press any key to the left of the E key, as shown below.

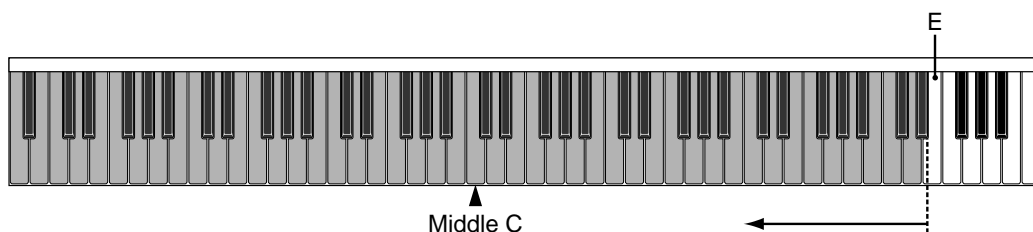

You can play individual songs or resume all song playback at anytime simply by pressing one of the keys shown below.

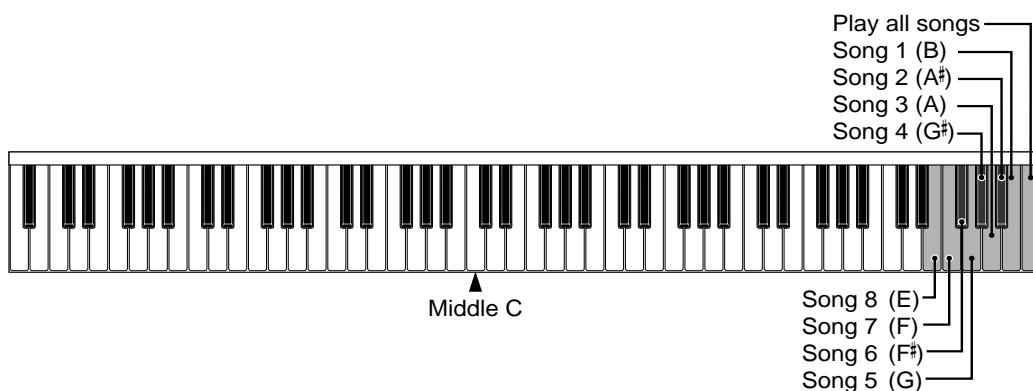

Cancelling Demo Song Mode

For normal piano playing you should cancel Demo Song mode. To do this, power down the *GranTouch*, wait a few seconds, and then power up again.

Troubleshooting

If you're having difficulty operating the *GranTouch*, or it doesn't seem to work as expected, look up the symptoms in the following table and follow the advice provided.

Symptom	Advice
Cannot power up the <i>GranTouch</i> (the power indicator is not lit).	Make sure the power cable is connected to an appropriate AC wall outlet.
	Make sure the power cable is connected to the <i>GranTouch</i> AC inlet correctly.
	Make sure that the POWER switch on the Control Box is set to the ON position.
A click sound can be heard when the <i>GranTouch</i> is powered up and down.	This is normal.
The <i>GranTouch</i> does not produce any sound.	Make sure that the VOLUME control is turned up (i.e. not set to minimum).
	If a pair of headphones are connected to one of the HEADPHONE sockets on the Control Box, the piano sound is not heard through the <i>GranTouch</i> speakers. Disconnect the headphones.
A rattling sound can be heard while playing the <i>GranTouch</i> .	This may be just the sound of the keys.
	Make sure that the Pedal Adjuster is set correctly (GT1 and GT2 only).
Cannot hear the reverb effect.	Make sure that the REVERB control is turned up (i.e. not set to minimum).
The piano sound has too much reverb and echo.	Turn down the REVERB control.
The pitch of the <i>GranTouch</i> does not match other instruments.	To correct this, set the <i>GranTouch</i> PITCH switch to match the pitch of the other instrument.
	If you cannot match the pitch of another instrument using the PITCH switch (i.e. the other instrument is out of the <i>GranTouch</i> 's adjustable range), adjust the pitch of the other instrument.
With another music source connected to the AUX IN connectors, the piano sound is too loud or too quiet.	You need to balance the volume levels of your <i>GranTouch</i> and music source. Use the volume controls on the <i>GranTouch</i> and music source to achieve this.
The <i>GranTouch</i> cannot send and receive MIDI data with other MIDI instruments.	Make sure the MIDI cables are connected correctly.
	The <i>GranTouch</i> sends and receives MIDI data on MIDI Channel 1. Make sure the other MIDI device is set to use MIDI Channel 1.
A Demo song suddenly starts playing.	The <i>GranTouch</i> is still in Demo Song mode. See page 10 for details on how to cancel this mode.

Specifications

Keyboard		Keys	Wooden piano keyboard 88 keys (7-1/4 octaves)
		Action	Acoustic grand piano action
Sensor System	Keys		Continuous-position optical sensors
	Hammers		One-beam, two-point optical speed sensors
	Pedals	Sustain	Continuous position sensor
		Sostenuto	On/off sensor
Shift		Continuous position sensor	
Tone Generation		Type	Digital stereo sampling with sustain pedal resonance effects
		Voice	Yamaha CFIIIS Concert Grand Piano Memory: 30-megabyte (wave memory)
		Polyphony	32-note stereo
		Pitch Control	438–445 hertz in 1 hertz steps Fine tuning in 1.2 cent steps
Reverb		Control	Continuous depth
		Type	Room
			Hall 1 (default) Hall 2
Other Controls		VOLUME control, POWER switch with power indicator	
Demo Songs		8	
Connectors		HEADPHONES	Stereo x 2
		MIDI	IN and OUT
		AUX IN	R and L/L+R
		AUX OUT	R and L/L+R
		Power	AC Power In
Internal Amplifier		60 W x 2	
Speakers		16 cm x 2, 10 cm x 2, 2.5 cm x 2	
Power Requirements		Local AC Current	
Dimensions		(W x D x H)	GT1: 148 x 88 x 97 cm (58" x 34 1/2" x 38") GT2: 149 x 88 x 97 cm (58 1/2" x 34 1/2" x 38")
		(L x W x H)	GT7: 149 x 146 x 99 cm (4'11" x 57" x 39")
Weight		GT1: 102 kg (224 lbs) GT2: 109 kg (240 lbs) GT7: 174kg (384 lbs)	
Supplied Accessories		AC power cord, <i>Owner's Manual</i>	
Optional Accessories		HPE-170 Headphones	

Specifications subject to change without notice.

MIDI Implementation Chart

Function...	Transmitted	Recognized	Remarks
Basic Channel Default Changed	1 X	1 X	
Mode Default Messages Altered	3 X *****	3 X X	
Note Number True Voice	21-108 *****	0-127 0-127	
Velocity Note On Note Off	0 0	0 0	
After Touch Keys Ch's	0 *1 X	0 *1 X	
Pitch bend	X	X	
Control Change 64 66 67 91 120 121	0 0 0 X X X	0 0 0 X 0 0	Sustain pedal Sostenuto pedal Shift pedal Reverb Depth All Sound Off Reset All Controllers
Prog Change :True#	X *****	X X	
System Exclusive	X	X	
System Common :Song Pos :Song Sel :Tune	X X X	X X X	
System Real Time :Clock :Commands	X X	X X	
Aux Messages :Local ON/OFF :All Notes OFF :Active Sense	X X 0 X	X 0 (123-125) 0 X	
Notes	*1 This function enables the GranTouch to transmit and receive the position of the keys as independent additional information, instead of continuously transmitting "key aftertouch" data based on key pressure applied after the keys are played.		

Mode 1: OMNI ON, POLY
Mode 3: OMNI OFF, POLY

Mode 2: OMNI ON, MONO
Mode 4: OMNI OFF, MONO

O: Yes
X: No

YAMAHA CORPORATION
P.O.Box 3, Hamamatsu, 430-8651 Japan