



YAMAHA

Owner's Manual

COMP



SPEED



DEPTH



TIME



FEE

DG-Stomp

GUITAR PRE-AMPLIFIER

WITH EFFECTS

FCC INFORMATION (U.S.A.)

1. IMPORTANT NOTICE: DO NOT MODIFY THIS UNIT!

This product, when installed as indicated in the instructions contained in this manual, meets FCC requirements. Modifications not expressly approved by Yamaha may void your authority, granted by the FCC, to use the product.

2. IMPORTANT:

When connecting this product to accessories and/or another product use only high quality shielded cables. Cable/s supplied with this product MUST be used. Follow all installation instructions. Failure to follow instructions could void your FCC authorization to use this product in the USA.

3. NOTE:

This product has been tested and found to comply with the requirements listed in FCC Regulations, Part 15 for Class "B" digital devices. Compliance with these requirements provides a reasonable level of assurance that your use of this product in a residential environment will not result in harmful interference with other electronic devices. This equipment generates/uses radio frequencies and, if not installed and used according to the instructions found in the users manual, may cause interference harmful to the operation of other electronic devices. Compliance with FCC regulations does not guarantee that

interference will not occur in all installations. If this product is found to be the source of interference, which can be determined by turning the unit "OFF" and "ON", please try to eliminate the problem by using one of the following measures:

Relocate either this product or the device that is being affected by the interference.

Utilize power outlets that are on different branch (circuit breaker or fuse) circuits or install AC line filter/s.

In the case of radio or TV interference, relocate/reorient the antenna. If the antenna lead-in is 300 ohm ribbon lead, change the lead-in to co-axial type cable.

If these corrective measures do not produce satisfactory results, please contact the local retailer authorized to distribute this type of product. If you can not locate the appropriate retailer, please contact Yamaha Corporation of America, Electronic Service Division, 6600 Orangethorpe Ave, Buena Park, CA90620

The above statements apply ONLY to those products distributed by Yamaha Corporation of America or its subsidiaries.

* This applies only to products distributed by YAMAHA CORPORATION OF AMERICA.

CANADA

This Class B digital apparatus complies with Canadian ICES-003.

Cet appareil numérique de la classe B est conforme à la norme NMB-003 du Canada.

- This applies only to products distributed by Yamaha Canada Music Ltd.
- Ceci ne s'applique qu'aux produits distribués par Yamaha Canada Musique Ltée.

ADVARSEL!

Lithiumbatteri—Eksplussionsfare ved fejlagtig håndtering. Udskiftning må kun ske med batteri af samme fabrikat og type. Levér det brugte batteri tilbage til leverandøren.

VARNING

Explosionsfara vid felaktigt batteribyte. Använd samma batterityp eller en ekvivalent typ som rekommenderas av apparattillverkaren. Kassera använt batteri enligt fabrikantens instruktion.

VAROITUS

Paristo voi räjähtää, jos se on virheellisesti asennettu. Vaihda paristo ainoastaan laitevalmistajan suosittelemaan tyyppiin. Hävitä käytetty paristo valmistajan ohjeiden mukaisesti.



The exclamation point within the equilateral triangle is intended to alert the user to the presence of important operating and maintenance (servicing) instructions in the literature accompanying the product.



The lightning flash with arrowhead symbol, within the equilateral triangle, is intended to alert the user to the presence of uninsulated "dangerous voltage" within the product's enclosure that may be of sufficient magnitude to constitute a risk of electrical shock.

NEDERLAND / NETHERLAND

- Dit apparaat bevat een lithium batterij voor geheugen back-up.
- This apparatus contains a lithium battery for memory back-up.
- Raadpleeg uw leverancier over de verwijdering van de batterij op het moment dat u het apparaat aan het einde van de levensduur afhandelt of de volgende Yamaha Service Afdeling:
Yamaha Music Nederland Service Afdeling
Kanaalweg 18-G, 3526 KL UTRECHT
Tel. 030-2828425
- For the removal of the battery at the moment of the disposal at the end of the service life please consult your retailer or Yamaha Service Center as follows:
Yamaha Music Nederland Service Center
Address : Kanaalweg 18-G, 3526 KL UTRECHT
Tel : 030-2828425
- Gooi de batterij niet weg, maar lever hem in als KCA.
- Do not throw away the battery. Instead, hand it in as small chemical waste.

IMPORTANT SAFETY INSTRUCTIONS

INFORMATION RELATING TO PERSONAL INJURY, ELECTRICAL SHOCK, AND FIRE HAZARD POSSIBILITIES HAS BEEN INCLUDED IN THIS LIST.

WARNING- When using any electrical or electronic product, basic precautions should always be followed. These precautions include, but are not limited to, the following:

1. Read all Safety Instructions, Installation Instructions, Special Message Section items, and any Assembly Instructions found in this manual **BEFORE** making any connections, including connection to the main supply.

2. Do not attempt to service this product beyond that described in the user-maintenance instructions. All other servicing should be referred to qualified service personnel.

3. Main Power Supply Verification: Yamaha products are manufactured specifically for the supply voltage in the area where they are to be sold. If you should move, or if any doubt exists about the supply voltage in your area, please contact your dealer for supply voltage verification and (if applicable) instructions. The required supply voltage is printed on the name plate. For name plate location, please refer to the graphic found in the Special Message Section of this manual.

4. DANGER-Grounding Instructions: This product must be grounded and therefore has been equipped with a three pin attachment plug. If this product should malfunction, the ground pin provides a path of low resistance for electrical current, reducing the risk of electrical shock. If your wall socket will not accommodate this type plug, contact an electrician to have the outlet replaced in accordance with local electrical codes. Do NOT modify the plug or change the plug to a different type!

5. WARNING: Do not place this product or any other objects on the power cord or place it in a position where anyone could walk on, trip over, or roll anything over power or connecting cords of any kind. The use of an extension cord is not recommended! If you must use an extension cord, the minimum wire size for a 25' cord (or less) is 18 AWG. NOTE: The smaller the AWG number, the larger the current handling capacity. For longer extension cords, consult a local electrician.

6. Ventilation: Electronic products, unless specifically designed for enclosed installations, should be placed in locations that do not interfere with proper ventilation. If instructions for enclosed installations are not provided, it must be assumed that unobstructed ventilation is required.

7. Temperature considerations: Electronic products should be installed in locations that do not seriously contribute to their operating temperature. Placement of this product close to heat sources such as; radiators, heat registers etc., should be avoided.

8. This product was NOT designed for use in wet/damp locations and should not be used near water or exposed to rain. Examples of wet /damp locations are; near a swimming pool, spa, tub, sink, or wet basement.

9. This product should be used only with the components supplied or; a cart ,rack, or stand that is recommended by the manufacturer. If a cart, rack, or stand is used, please observe all safety markings and instructions that accompany the accessory product.

10. The power supply cord (plug) should be disconnected from the outlet when electronic products are to be left unused for extended periods of time. Cords should also be disconnected when there is a high probability of lightning and/or electrical storm activity.

11. Care should be taken that objects do not fall and liquids are not spilled into the enclosure through any openings that may exist.

12. Electrical/electronic products should be serviced by a qualified service person when:

- The power supply cord has been damaged; or
- Objects have fallen, been inserted, or liquids have been spilled into the enclosure through openings; or
- The product has been exposed to rain; or
- The product does not operate, exhibits a marked change in performance; or
- The product has been dropped, or the enclosure of the product has been damaged.

13. This product, either alone or in combination with an amplifier and headphones or speaker/s, may be capable of producing sound levels that could cause permanent hearing loss. DO NOT operate for a long period of time at a high volume level or at a level that is uncomfortable. If you experience any hearing loss or ringing in the ears, you should consult an audiologist.

IMPORTANT: The louder the sound, the shorter the time period before damage occurs.

14. Some Yamaha products may have benches and/or accessory mounting fixtures that are either supplied as a part of the product or as optional accessories. Some of these items are designed to be dealer assembled or installed. Please make sure that benches are stable and any optional fixtures (where applicable) are well secured **BEFORE** using. Benches supplied by Yamaha are designed for seating only. No other uses are recommended.

PLEASE KEEP THIS MANUAL



Owner's Manual

Thank you for purchasing the YAMAHA DG-Stomp Guitar Preamplifier.

To fully understand the functions and to obtain maximum life of this device, please read this Owner's Manual carefully before using. Also, after reading this manual, please keep it and the warranty in a safe place for future reference.

Contents

Precautions	5	Tuner Mode	22
Nomenclature	6	■ How to Enter the Tuner Mode	22
■ Top Panel	6	■ Tuning	22
■ Rear Panel	9	■ Setting the Standard Pitch	22
Connections	10	Utility Mode	23
■ Connecting the Power	10	■ About the Utility Mode	23
■ Connecting an Amp and Speaker System	10	■ Foot Switch Functions	23
■ Connecting Headphones	11	■ MIDI Functions	24
■ Digital Output	11	■ External Control Settings	25
■ Connecting an Expression (EXP) Pedal	11	■ EXP Pedal Settings	26
■ Connecting MIDI Devices	11	■ Wah Pedal Settings	27
Using the DG-Stomp	12	■ The Speaker Simulator	27
■ Produce Sound	12	■ Preamp Circuit ON/OFF Settings	27
■ Try Changing the Settings	13	Error Messages	28
■ Try Selecting Another Patch	15	Trouble Shooting	28
■ Create and Store a Patch	17	Specifications	29
■ Convenient Functions	17	MIDI Implementation Chart	30
Effect Functions and Parameters	19		
External Control Settings	21		

Precautions

- Avoid using the DG-Stomp in the following locations to prevent possible damage:
 - In direct sunlight or next to heating equipment.
 - In extremely cold or hot locations.
 - Locations exposed to high humidity or excessive dust.
 - Locations subject to strong shocks or vibration.
- Before making any connections, make sure that the power is switched OFF on the DG-Stomp and any external devices.
- To protect speakers from possible damage, always set the OUTPUT knob to “0” before switching the power ON/OFF.
- When connecting a speaker to this unit, make sure that the power is switched OFF first.
- Do not apply excessive force to the switches, knobs and controls.
- The DG-Stomp is a precision device. Handle it with care and avoid dropping or jarring it.
- Operating temperatures will rise during use. Make sure the DG-Stomp is used in a well-ventilated area.
- For safety, always remove the power adaptor from the AC wall outlet if there is any danger of lightning striking in your area.
- Keep the DG-Stomp away from neon signs or fluorescent lighting to prevent noise pickup.
- To prevent damage and possibly electrical shock, never open the case and tamper with the internal circuitry.
- Never use benzene, thinner or other volatile liquids for cleaning, as these chemicals may cause damage or discoloration to the finish. Always use a dry, soft cloth to wipe off dust and dirt.

About the Backup Battery

A backup battery (lithium battery) is used to keep internal data (settings) from being lost, even when the power cord is unplugged. Internal data will be lost when battery power is depleted, so it is recommended that data be stored to an external data recorder such as the Yamaha MIDI Data Filer MDF3 (→ page 24), or keep records of settings in memo form. The average battery life span is about 3 years. When replacement becomes necessary contact the music store where the unit was purchased, or a qualified service representative, to perform the replacement.

- *Do not attempt to replace the backup battery by yourself.*
- *Keep the backup battery out of reach of children.*
- *“E5” appears in the display when the battery becomes depleted. Internal data may be lost.*
- *Data may be lost if the unit is improperly handled or if repairs are performed.*

Nomenclature

■ Top Panel

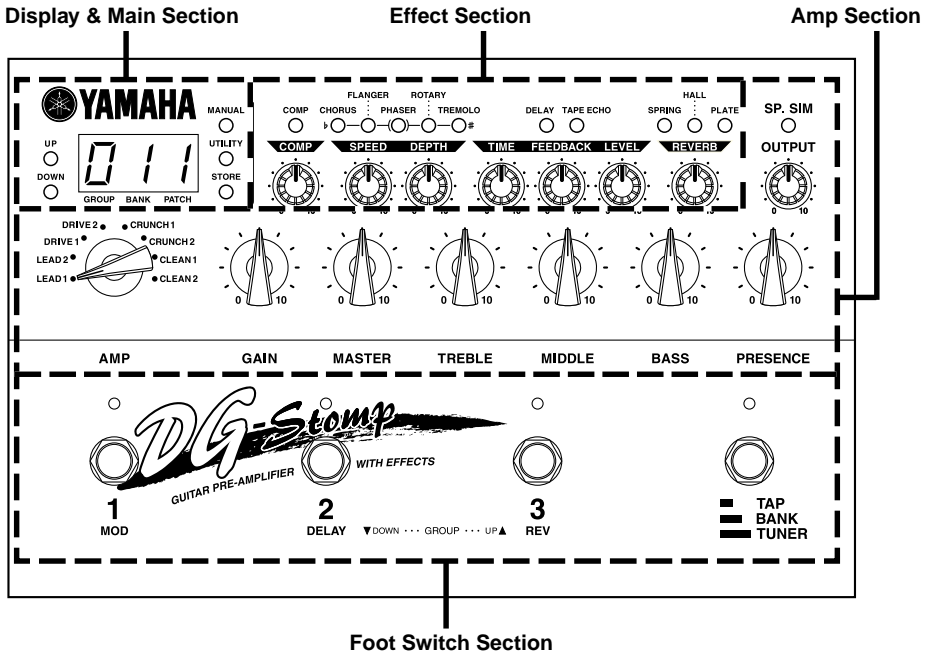

● Display & Main Section

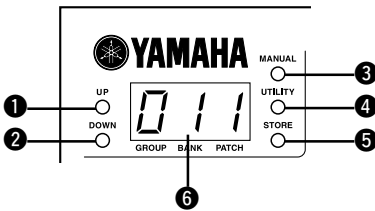

① Up Button (UP)

② Down Button (DOWN)

Press to change the Patch Number by +1/-1. Hold to change the Group Number by +1/-1. Simultaneously press the [UP] and [DOWN] buttons to switch between the USER ↔ PRESET Areas.

Also, their flashing lamps are used to indicate the relationship between the patch data value and the knob's position.

③ Manual Button (MANUAL)

Independent of the selected patch's settings, this button changes the sound to the settings of the knob's current position.

The lamp will flash if the patch setting is changed. Press the [MANUAL] and [UTILITY] buttons simultaneously to enter the External Control Setting Mode. (→ page 21)

④ Utility Button (UTILITY)

Enters the Utility Mode. (→ page 23) Press the [UTILITY] and [STORE] buttons simultaneously to enter the Tuner Mode. (→ page 22)

⑤ Store Button (STORE)

Enters the Store Mode. (→ page 17)

⑥ Display

Displays memory numbers, parameter setting values, etc.

● Amp Section

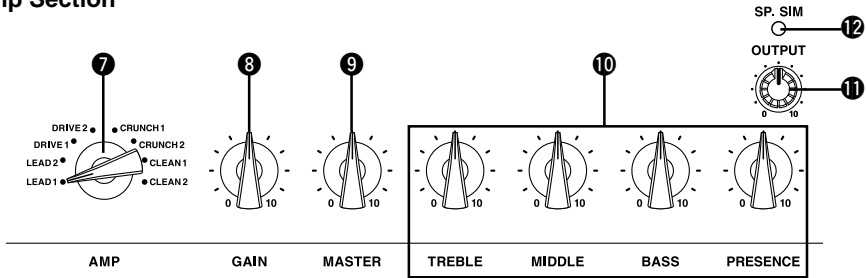

7 Amp Select Switch (LEAD1-CLEAN2)

Selects one of the eight preset guitar amplifier types. In the Utility Mode it is used to select functions you want to set such as Foot Switch or MIDI functions, etc.

8 Gain Control (GAIN)

Adjusts the amount of distortion.

** No sound will be produced if this knob is set to "0", even if the Master Volume 9 level is increased.*

9 Master Volume (MASTER)

Sets the absolute volume of the tone wet with the Gain Volume and Tone Controls.

** The MASTER knob's setting is saved in memory.*

10 Tone Controls

(TREBLE, MIDDLE, BASS, PRESENCE)

Controls the sound level of each tone.

11 Output Level Control (OUTPUT)

Controls the level of the signal delivered from the DG-Stomp's output jacks (OUTPUT, PHONES)

** The OUTPUT knob's setting is not saved in the memory.*

12 Speaker Simulator Button (SP. SIM)

Switches the Speaker Simulator ON (lamp lit)/OFF (lamp off).

Press the [SP. SIM] and [UTILITY] buttons simultaneously to select the simulator type. (→ page 14)

● Effect Section (Refer to: "Effect Functions and Parameters" on page 19)

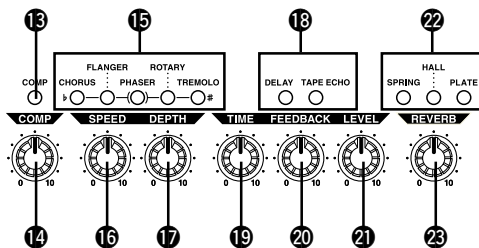

13 Compressor Button (COMP)

Switches the Compressor ON (lamp lit)/OFF (lamp off).

14 Compressor Knob (COMP)

Adjusts the depth of the compressor's effect. Turn to the right to increase the depth of the effect.

Nomenclature

15 Modulation Group Effect Buttons (CHORUS/FLANGER/PHASER/ROTARY/ TREMOLO)

These buttons set the type of Modulation Effect to be used. The selected effect's lamp will light.

A secondary parameter for the effect can be set by turning the SPEED or DEPTH knob while holding the button of the currently selected effect.

16 Speed Knob (SPEED)

Sets the Speed parameter and a secondary parameter of the Modulation Group's Effects.

17 Depth Knob (DEPTH)

Sets the Depth parameter and a secondary parameter of the Modulation Group's Effects.

18 Delay Group Effect Buttons (DELAY/TAPE ECHO)

These buttons set the type of Delay Effect to be used. The selected effect's lamp will light.

19 Time Knob (TIME)

Sets the Delay time.

20 Feedback Knob (FEEDBACK)

Sets how many times the delay will repeat.

21 Level Knob (LEVEL)

Sets the Delay's volume level.

22 Reverb Group Effect Buttons (SPRING/HALL/PLATE)

These buttons set the type of Reverb Effect to be used. The selected effect's lamp will light.

23 Reverb Knob (REVERB)

Sets the amount of Reverb that is added to the sound.

● Foot Switch Section

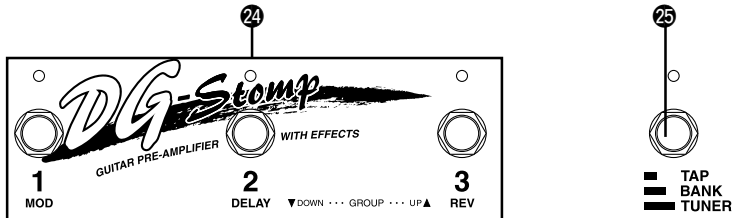

24 Foot Switches 1, 2, 3

According to the settings in the Utility Mode (→ page 23), the switches can be used as for the following functions.

- Selects a patch (1/2/3) from the currently selected bank.
- Switches the effect blocks ON/OFF (1: Modulation Block, 2: Delay Block, 3: Reverb)

25 Bank Switch (TAP/BANK/TUNER)

- **Tap the switch:** Sets the Delay Time according to the tempo at which the switch is tapped. (→ page 20)
- **Press the switch until the display flashes:** Use the foot switches 1-3 to change the Area/Group/Bank. (→ page 16)
- **Hold the switch until “ $\text{L} \cup$ ” appears in the display:** Enters the Tuner Mode. (→ page 22)

■ Rear Panel

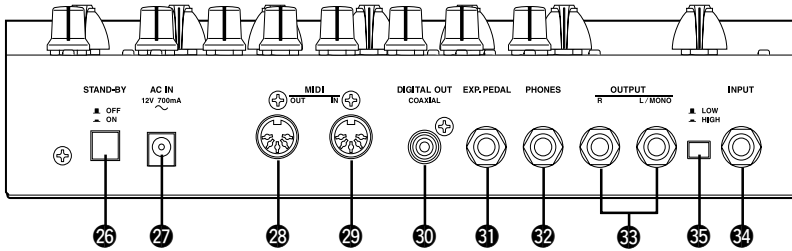

26 Power Switch (STAND-BY ON/OFF)

Power switch for the main unit.

* To protect the speakers, set the **OUTPUT knob (11)** to "0" before switching the power ON/OFF.

27 Power Adaptor Jack (AC IN 12V 700mA)

Connect the supplied power adaptor to this jack.

* Never use a power adaptor other than the supplied adaptor. Use of any other power adaptor may cause damage, overheating, fire, etc.

28 MIDI OUT Jack

Jack used for transmitting MIDI data from the DG-Stomp such as control changes, program changes, data in the DG-Stomp's memory, etc. (→ page 24).

29 MIDI IN Jack

Jack used for receiving MIDI data from a MIDI device, such as a MIDI foot controller, that can be used to control the volume, or each of the effects and select patches in the DG-Stomp. (→ page 16). Also, DG-Stomp memory data saved to an external MIDI device can be returned to the DG-Stomp via this jack. (→ page 25)

30 Digital Out Jack (DIGITAL OUT)

Jack used for sending the output of the DG-Stomp as digital data. Connect to a device equipped with a digital input jack (COAXIAL) such as a digital mixer, etc. (→ page 11).

31 EXP Pedal Jack (EXP. PEDAL)

Connect a foot controller (expression pedal) (optional) such as the YAMAHA FC-7, etc. to this jack, and control DG-Stomp parameters or use the device as a wah pedal. (→ pages 21, 25)

32 Headphones Jack (PHONES)

Connect a pair of headphones (optional) to this jack for private practice or practicing at night when you don't want to disturb others. (→ page 11).

* Even when headphones are used, the audio signal is delivered from the **OUTPUT jack (33)** and the **DIGITAL OUT jack (30)**.

33 Output Jacks (OUTPUT R, L/MONO)

The analog output jacks for the DG-Stomp. Connect these jacks to the input jack on a power amplifier + speaker set or guitar amp, mixer, etc. (→ page 10)

* Use the **L/MONO** jack when connecting to a monaural device.

34 Input Jack (INPUT)

35 Input Level Switch (LOW/HIGH)

The DG-Stomp's input jack. Connect a guitar here. Select either LOW/HIGH to match the output level of the guitar you are using. Use the LOW setting for high output guitars and the HIGH setting for low output guitars.

* Make sure the power is switched OFF before connecting a guitar.

Connections

! Before making any connections to any of the DG-Stomp's INPUT and/or OUTPUT jacks, make sure that the power on the DG-Stomp and all other devices is turned OFF to prevent electrical shock or damage to the devices.

■ Connecting the Power

Use the supplied power adaptor (AC-10) to supply power to the DG-Stomp.

1. Make sure the DG-Stomp's Power Switch (STAND-BY) is in the OFF (■) position.
2. Connect the power adaptor's plug to the AC IN jack on the DG-Stomp.
3. Connect the power adaptor to an electric outlet.

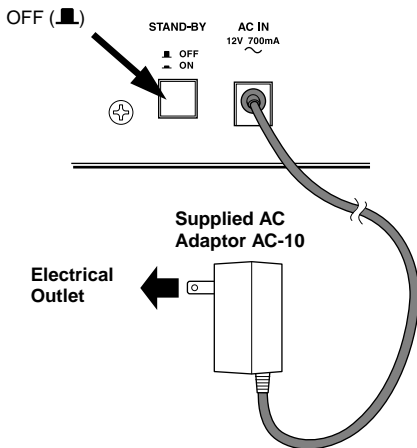

! Only use the supplied AC-10 adaptor to power the unit. Using another adaptor may result in damage, overheating or fire, which can be very dangerous.

! Make sure to use the recommended AC voltage as indicated on the power adaptor.

! The supplied power adaptor AC-10 is designed specifically for use with the DG-Stomp. Never use this adaptor with any other device.

■ Connecting an Amp and Speaker System

To setup with your guitar amp system, connect the OUTPUT jack on the DG-Stomp to a power amp and speaker.

1. Use a cable to connect the OUTPUT (R, L/MONO) jack(s) on the rear panel of the DG-Stomp to the INPUT jack of a power amp.

** We recommend the use of a stereo audio device to enjoy the full benefits of the stereo effects.*

2. Connect a speaker to the speaker jack on the power amp.

** Make sure that the speaker connected to the power amp is a compatible device (capacity, system impedance).*

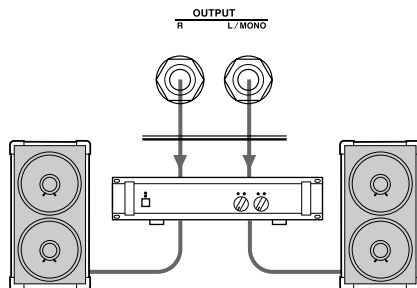

● You can connect the DG-Stomp to a guitar amp.

** If the guitar amp is equipped with an effects loop, we recommend that the DG-Stomp be connected directly to the amplifier's EFFECT RETURN jack. If the amplifier is not equipped with an effects loop, connect to its INPUT jack and adjust the tone and volume on the guitar amp as required.*

** When connecting to monaural input devices, use the DG-Stomp's L/MONO jack.*

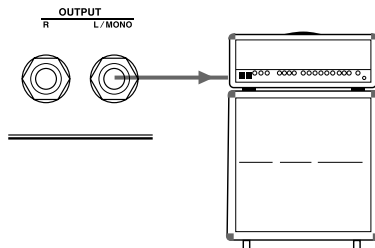

● You can also connect to the input jack on a mixer, etc.

■ Connecting Headphones

Connect a pair of headphones to the PHONES jack (standard stereo) on the DG-Stomp to play or practice in private.

The volume of the headphones can be controlled with the OUTPUT knob.

** When a pair of headphones is connected, the output from the OUTPUT jack and the DIGITAL OUT jack will still deliver sound output.*

PHONES

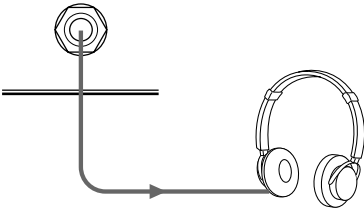

When using headphones, use at a comfortable volume so as not to cause shock to your hearing.

■ Digital Output

The DG-Stomp is equipped with a DIGITAL output jack (COAXIAL), that can be connected to the DIGITAL INPUT jack on a digital mixer, MD recorder, etc.

** The output level of the DIGITAL OUT jack cannot be controlled with the OUTPUT knob (fixed).*

DIGITAL OUT
COAXIAL

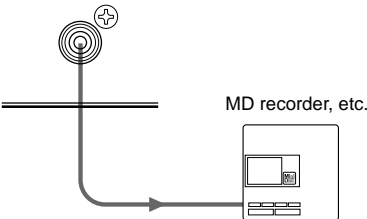

■ Connecting an Expression (EXP) Pedal

A foot controller (expression pedal), such as the YAMAHA FC-7, connected to the EXP. PEDAL jack on the DG-Stomp allows control of the DG-Stomp's individual parameters or use as a wah pedal. (See pages 21, 25)

EXP. PEDAL

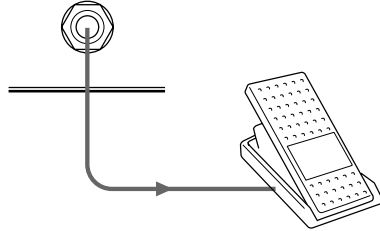

■ Connecting MIDI Devices

Using the MIDI IN/OUT jacks allows the exchange of MIDI information between the DG-Stomp and an external MIDI Device.

Data from the DG-Stomp can be stored in MIDI devices such as the YAMAHA MIDI Data Filer MDF3, etc. also, data from the external device can be loaded into the DG-Stomp.

Also, a MIDI foot controller, etc. can be used to select patches in the DG-Stomp, control individual parameters, set individual effects, etc. Refer to the [Utility Mode] (page 23) for more information on MIDI functions.

Using the DG-Stomp

First, connect a guitar to the DG-Stomp and try some sounds.

■ Produce Sound

1. Before connecting, turn off the power on the DG-Stomp and connect a guitar to the INPUT jack on the rear panel.

When connecting a high impedance guitar set the switch to LOW (⬇️), set the switch to HIGH (⬆️) when connecting a low impedance guitar.

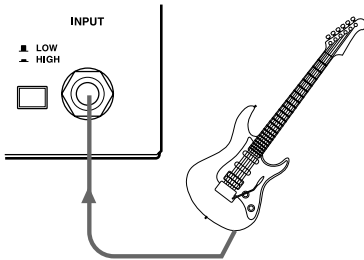

2. After rotating the OUTPUT knob to the "0" position, turn the POWER switch (STAND-BY) to ON (⬆️).

! Turning the POWER switch ON when the OUTPUT knob is turned up may result in damage to devices such as amplifier, speaker, headphone, etc., or cause unexpected accidents like damage to your hearing due to a high volume setting.

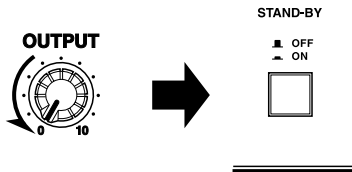

3. A 3-digit number "0 1 1" will appear on the display.



The numbers (Group number: 0, Bank number: 1, Patch number: 1) refer to the patch that is currently selected.

Note: When the patch's number is shown on the display the device is in a condition called the PLAY MODE. When in the PLAY MODE, it is possible to select a patch and use the knobs or buttons to change settings to play.

For now use this patch to try and produce some sound.

4. Play a chord on the guitar and rotate the OUTPUT knob to the right to control the volume.



■ Try Changing the Settings

Use the knobs or buttons on the panel to create your own original tone.

● Try creating your own sound

Knob positions do not represent the current patch's value settings so the knob must be aligned with its setting value (editable condition) in order to make changes to the value. For this reason, the following rules apply when a knob is moved.

- Rotate a knob, if the [UP] lamp flashes, rotate the knob to the right (toward 10). If the [DOWN] lamp flashes, rotate the knob to the left (toward 0). At this time, that patch's data value (the value set in the patch of the knob you are turning) will flash on the display.

** As long as the value is flashing on the display, the tone and value will not change when the knob is rotated.*

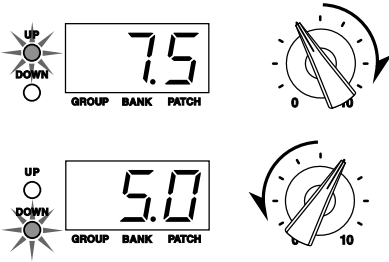

- Continue rotating the knob in the previously described direction and the patch's data value shown in the display as well as the [UP]/[DOWN] lamp will stop flashing and indicate the actual value corresponding to the knob's position.

** After you stop moving the knob, the value will be displayed for about 2 more seconds after which it will return to the normal display.*

** Even if only one setting value is changed, the [MANUAL] lamp will flash to indicate that the patch's data has changed. When settings for all knobs (with the exception of OUTPUT) have changed, the [MANUAL] lamp will light.*

- Once the knob is in an editable condition (in which the setting's value can be changed), turning the knob will result in the value shown in the display changing in regards to the knob's position and a relative change in the tone.

The previously described rules apply to all knobs except the OUTPUT knob.

The AMP SELECT switch functions in the same manner. When the knob is rotated, the patch's selected amp type will flash on the display. Rotate the knob to the position of the amp type indicated in the display and then select an amp type you want to use.

The OUTPUT knob and MASTER knob

Either knob can be used to change the volume. However, the MASTER knob setting is included with the patch data while the OUTPUT knob setting is not. Use the MASTER knob to set the volume of each patch and use the OUTPUT knob to set the volume as heard from the speaker.

● Change the Effect Setting

Try switching the each of the effect blocks ON/OFF or try changing the effect. Also, try using the knobs for each of the effects to change the character of the effect.

The DG-Stomp's effects section is divided into the following 4 blocks,

- Compressor (COMP)
 - Modulation (CHORUS/FLANGER/PHASER/ROTARY/TREMOLO)
 - Delay (DELAY/TAPE ECHO)
 - Reverb (SPRING/HALL/PLATE)
- Press the corresponding button to select the effect you want to use (the lamp will light). However, only one effect per block can be used at a time. Also, if a button that is lit (ON) is pressed, the light will go off and the effect in that block will be switched (OFF).

All knobs can be used to set the parameters of the effect selected in the block.

** Refer to [Effect Functions and Parameters] (page 19) for more information on each effect's function or knob's setting.*

** The operation of each knob follows the same rules as the pre-amplifier section.*

Using the DG-Stomp

● Set the Speaker Simulator

The speaker simulator is a special circuit that adds the live characteristics of a speaker to the tone output of the DG-Stomp. It is best used when you are listening through a pair of headphones or when connected directly via a line to a mixer or recorder.

Press the [SP. SIM] button to turn the Speaker Simulator ON (the lamp will light). Press the button again to turn the Speaker Simulator OFF (light is off).

Also, the DG-Stomp is equipped with 16 types of speaker simulations. Try to find a simulation you like.

1. Simultaneously press the [SP. SIM] button and the [UTILITY] button.

After "SP.S" appears in the display, the currently selected simulation type will be displayed. The four types of simulation are as follows.

- $A42$: American Style 12-inch x4
- $B42$: British Style 12-inch x4
- $M42$: Modern 12-inch x4
- $Y42$: YAMAHA 12-inch x4
- $H42$: Hybrid 12-inch x4
- $A22$: American Style 12-inch x2
- $B22$: British Style 12-inch x2
- $M22$: Modern 12-inch x2
- $Y22$: YAMAHA 12-inch x2
- $H22$: Hybrid 12-inch x2
- $A12$: American Style 12-inch x1
- $M12$: Modern 12-inch x1
- $Y12$: YAMAHA 12-inch x1
- $H12$: Hybrid 12-inch x1
- $Y10$: 10-inch x4
- $M10$: 10-inch x2

2. Use the [UP]/[DOWN] buttons to select the simulator type.
3. Press the [UTILITY] button to return to the PLAY mode.

* The speaker simulator's setting is stored along with the patch data. It is also possible to use Utility settings to turn the speaker simulator ON or OFF independent of the patch data settings (see page 27)

* If the MASTER volume or tone controls are set relatively high, the sound may clip when the Speaker Simulator circuit is activated. If so, slightly lower the MASTER volume level.

When another patch is selected, any settings you have altered will revert to their original settings.

If you want to save those settings, please use the Store operation described on page 17.

■ Try Selecting Another Patch

The DG-Stomp holds a total of 180 patch programs (patch) in its internal memory. The 180 patches are divided into two areas each containing 10 groups, 3 banks and 3 patches.

• AREA

There are two areas, the **USER AREA** and the **PRESET AREA**. When the Store operation is used, data in the USER AREA (90 patches) can be freely rewritten. You can change settings in the PRESET AREA (90 patches) data but you can not rewrite the contents to the PRESET AREA memory.

When a PRESET AREA patch is selected, a dot will appear to the lower right of the hundred's digit on the display (0.11-9.33) When the dot is not lit (011-933), it indicates that a patch in the USER AREA is selected.

** When the DG-Stomp is shipped from the factory, the same patch data as found in the PRESET AREA is used in the USER AREA. Refer to the [Patch List] on the separate "Patch List" sheet.*

• GROUP

The 90 patches in each area are divided into 10 groups (0-9).

• BANK

Each group is divided into 3 banks (1-3).

• PATCH

Each bank contains 3 patches (1-3).

Try selecting some of the different patches and try out some of the different sounds.

To select a different patch, use one of the three methods described below.

● Using the [UP]/[DOWN] buttons on the panel

- Each time the [UP] button is pressed, the next greater **patch number** is selected.

011 → 012 → 013 → 021 → 022 →
023 → 033 → 111 → ... → 933 → 011 →
012 → ... → 933 → 011 (returns to the top)...

Every time the [DOWN] button is pressed, the next lower **patch number** is selected.

- Press the [UP] button continuously increases the **group number** by one (1).

011 → 111 → 211 → ... → 911 → 011 →
111 → 211 → ... → 911 → 011 (returns to the top)...

Press the [DOWN] button continuously decreases the **group number** by one (1).

- Press the [UP] and [DOWN] button simultaneously to switch between the **USER AREA** ↔ **PRESET AREA**.

011 ↔ 0.11

• Patch Characteristics

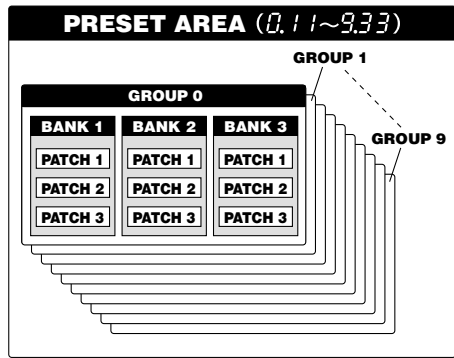
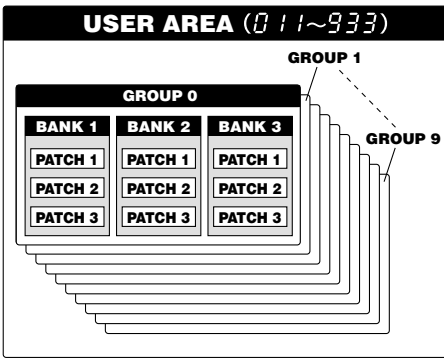

Using the DG-Stomp

● Using the Foot Switch and the Bank Switch

- Press a foot switch (1-3) to select the corresponding patch number 1-3 in the currently selected group/bank.

** If the Foot Switch's function is set to "EFF" in the Utility mode, it will not be possible to select a patch using the Foot Switch. (See page 23)*

- Press and hold the BANK switch until the display and the foot switch lamp flashes then remove your foot. In this condition, the following procedure can be used.

** Even if the Foot Switch function is set to "EFF" in the Utility Mode, this mode can be entered by stepping on the BANK switch.*

1. Hold Foot Switch 1 for more than one second to switch between the **USER AREA** ↔ **PRESET AREA**. When the area is changed, the Foot Switch's lamps will flash.
2. Hold Foot Switch 2 for more than one second to decrease the **group number** by a value of one. When the Group number is changed, the Foot Switch's lamps will flash.
3. Hold Foot Switch 3 for more than one second to increase the **group number** by a value of one. When the Group number is changed, the Foot Switch's lamps will flash.
4. Press a Foot Switch (1-3) to select the corresponding **bank number (1-3)**.
5. When a BANK is selected, the lamp in the display and foot switch lamp will flash quickly. Press a Foot Switch (1-3) at this time to select the corresponding **patch number (1-3)**.

** To cancel the selected patch, press the BANK switch. It will return to the previous condition.*

● Using MIDI Control

MIDI program change data transmitted from an external MIDI device such as the YAMAHA MIDI Foot Controller MFC10, etc. can be used to select patches in the DG-Stomp.

1. Use a MIDI cable to connect the MIDI IN jack on the DG-Stomp to the MIDI OUT jack on an external MIDI device.

** Make sure to use a MIDI cable that conforms to the MIDI standard. Also, limit the length of the MIDI cable to 15 meters. Use of a long cable may result in trouble such as inferior performance of the device, etc.*

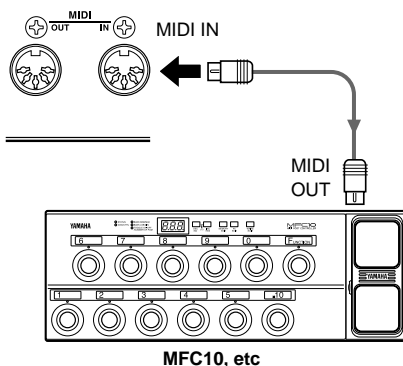

2. Match the DG-Stomp's MIDI receive channel with the MIDI transmit channel on the external MIDI device.

→ page 24 [Set the MIDI Receive Channel]

3. Create a Program Change Table*. (Factory default → Program Change No : Patch No. = 1:011, 2:012...128:4.12)

→ page 24 [Create a Program Change Table]

** This operation is used to assign patch numbers to a corresponding program change number received from an external device. For example, when the program change number "1" is received, the DG-Stomp's patch number "113" is recalled.*

4. When program change data is transmitted from an external MIDI device, the patch is selected that corresponds to the program change table you created.

** Refer to the owner's manual for your external MIDI device for instructions on how to transmit program change data.*

■ Create and Store a Patch

Original settings can be stored in the USER AREA (011-933). Try creating an original patch and then store it.

● Storing Procedure

1. Press the [STORE] button.
When you enter the Store Mode, the display, the [STORE] lamp and the foot switch lamp corresponding to the patch number will flash.
2. Select the patch (group, bank, patch number) to which you want to store the patch.
Use the same procedure as described in [Try Selecting Another Patch] (page 15) to select a patch. You can use the [UP]/[DOWN] buttons, the foot switches and the BANK switch to select the patch number. However, you cannot change the AREA (it can only be assigned to the USER AREA).
3. After select the patch you want to store your patch in, hold the [STORE] button.
The store operation is complete when all lamps light.

* Utility mode settings are not stored with patch data. As common settings for all patches, their contents are stored in the DG-Stomp memory.

* The OUTPUT knob's setting is not stored with the patch data. Use the MASTER knob to set differences in volume for situations like backing, soloing, etc.

* Data in the USER AREA (011-933) can be stored in an external MIDI device. (→ page 24)

This procedure can be used to store original patches and also used to rearrange the order of patches for use during live performance.

■ Convenient Functions

Here are some convenient functions that you can use with the DG-Stomp.

● Use Foot Switches 1-3 to Switch Effects ON/OFF

You can set Foot Switch 1 to act as an ON/OFF switch for the modulation effect, Foot Switch 2 as an ON/OFF switch for the delay effect, and Foot Switch 3 as an ON/OFF switch for the reverb effect.

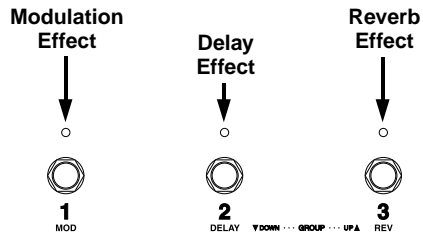

1. Press the [UTILITY] button and set the amp select switch to the LEAD 1 position.
After entering the Utility Mode, "F.S" will appear on the display and then the currently selected foot switch function will be displayed.
 - $\overline{P} \overline{R} \overline{U}$: Select a patch
 - $\overline{E} \overline{F} \overline{F}$: Switches the effect block ON/OFF
2. Use the [UP]/[DOWN] buttons to set the foot switch function to "EFF".
3. Press the [UTILITY] button to return to the Play Mode.
4. Press Foot Switches 1-3 to switch the corresponding effect block ON/OFF.

* To change the Bank, Group or Area, press and hold the BANK switch until the display and the Foot Switch lamp flashes. (→ page 16)

Using the DG-Stomp

● Using the DG-Stomp Without Patches

The [MANUAL] button lets you control the DG-Stomp when patches are not used.

Press the [MANUAL] button to enter the Manual Mode (the lamp lights). In this mode, all knobs and effect buttons are set to their present condition.

In the Manual Mode, changes to any knob or button can be performed directly.

To cancel the Manual Mode, simply recall a patch. Press the footswitch (1-3) that corresponds to the patch number shown on the display to return the DG-Stomp to the same condition previous to entering the Manual Mode.

Also, the Manual Mode will be exited and the [MANUAL] lamp will flash if the Modulation Effect's secondary parameters are changed.

● Using a Foot Pedal (Controller)

Connecting an optional foot controller (expression pedal) such as the YAMAHA FC-7, etc., to the EXP. PEDAL jack lets you control DG-Stomp's volume, tone or effect parameters (setting values) and use the device as a Wah pedal.

→ page 21 [External Control Settings]

● Controlling the DG-Stomp from an External MIDI Device

Using a MIDI cable to connect the MIDI IN jack on the DG-Stomp to the MIDI OUT jack on an external MIDI device lets you control DG-Stomp's volume, tone and effect parameters (setting values) and use the device as a Wah pedal.

→ page 21 [External Control Settings]

● Chromatic Auto Tuner Function

The Tuner Mode can be accessed while in the Play Mode by simultaneously pressing the [UTILITY] button and the [STORE] button or, holding the BANK switch until "♮" appears in the display. The Tuner Mode provides a chromatic tuner for tuning.

→ page 22 [Tuner Mode]

● Factory Default

To return the DG-Stomp to its factory-preset condition, hold the buttons [UP] and [MANUAL] and turn the Power ON (▲). The DG-Stomp will then be reset to its factory defaults and all data in the USER AREA will be rewritten with data for the patches listed in the Patch List (on the separate "Patch List" sheet).

When the DG-Stomp is reset to its factory default condition, all data stored in memory is erased. We recommend that any important data be stored in an external MIDI device or that notes be taken of the settings.

Effect Functions and Parameters

Compressor

● Comp (Compressor)

Controlling the input signal (peak) this effect keeps the maximum level constrained to the level set with the knob.

- **COMP knob**
Rotate the knob to the right to increase the depth of the compression.
When set to "0.0" it will have no effect.

Modulation Effects

There are five modulation effects, CHORUS, FLANGER, PHASER, ROTARY and TREMOLO.

- The two knobs controlling modulation parameters are double duty knobs. As is, they control speed and depth of the selected effect but holding the currently selected effect's button while turning the knob can access a second function for each knob.
- Secondary function parameters are also stored with the patch's data. When a patch is selected, the secondary parameter settings that are stored in the patch's data will be assigned to the patch.
- When a different modulation effect is selected from the modulation effect block, the previous effect's settings will be used for the SPEED and DEPTH knob's individual parameter values. Secondary parameter values are set to the value most recently used for the selected effect. (Secondary parameter values are always stored in the unit with individual effects.)
- To return the secondary parameter's setting to its factory default value, hold that effect's button until the five modulation effect lamps are lit.

● CHORUS

This is a typical chorus effect.

- **SPEED knob**
Sets the speed at which the pitch will vibrate.
- **DEPTH knob**
Sets the depth at which the pitch will vibrate.
- **SPEED knob + [CHORUS]**
Sets the delay time.
- **DEPTH knob + [CHORUS]**
Sets the mix level of the chorus effect.

● FLANGER

Creates a sound resembling a jet.

- **SPEED knob**
Sets the speed at which the pitch will vibrate.
- **DEPTH knob**
Sets the depth at which the pitch will vibrate.
- **SPEED knob + [FLANGER]**
Sets the delay time.
- **DEPTH knob + [FLANGER]**
Sets the feedback level.

● PHASER

This changes the cyclical phase to give the sound a wave like motion.

- **SPEED knob**
Sets the speed at which the phase changes.
- **DEPTH knob**
Sets the depth of the phase.
- **SPEED knob + [PHASER]**
Sets the feedback level.
- **DEPTH knob + [PHASER]**
Sets the mix level of the phase effect.

● ROTARY (Rotary Speaker)

This effect simulates a two-way rotary speaker.

- **SPEED knob**
Sets the rotation speed of the low frequency speaker.
- **DEPTH knob**
Sets the rotation speed of the high frequency speaker.
- **SPEED knob + [ROTARY]**
Sets the angle at which the left and right microphones are set in relation to the speaker. A setting of "0" will produce a monaural sound while a setting of "10.0" will produce a microphone placement of 180 degrees.
- **DEPTH knob + [ROTARY]**
Sets the volume balance between the high frequency speaker and low frequency speaker.

● TREMOLO

This effect changes the volume cyclically.

- **SPEED knob**
Sets the speed at which the volume changes.
- **DEPTH knob**
Sets the range in which the volume changes.

Effect Functions and Parameters

- **SPEED knob + [TREMOLO]**

Sets the phase difference between the left and right sounds. From 0 degrees to 360 degrees (0.0-10.0). Set to "5" the knob works like a stereo pan pot.

- **DEPTH knob + [TREMOLO]**

Sets the wave shape of the tremolo. A setting of "0.0" produces a triangular wave. Rotate the knob to the right to change the shape to a trapezoid with its sharpness increasing the more the knob is turned.

Delay Effects

There are two effects, DELAY and TAPE ECHO.

- **DELAY**

This is a digital delay effect. The sound played will be repeated after a determined pause.

- **TIME knob**

Sets the delay time (from the time of the original sound to the time of the delay).

When the delay effect is used, it is possible to set the TIME parameter (delay time) by tapping on the BANK switch. Tap a few times on the BANK switch in the tempo you want to set the delay to. The interval in which the switch was tapped will be set in the TIME parameter.

- **FEEDBACK knob**

Sets the number of times the effect will repeat.

** Too high of a setting may result in an uncontrolled oscillation of sound. Please use caution.*

- **LEVEL knob**

Controls the volume of the source signal into the Delay circuit.

** If the same Delay setting is switched from a patch using a LEVEL other than "0" to a patch using a LEVEL of "0", the remaining Delay will be leftover. Of course, the sound of the new patch will not be affected by the delay.*

- **TAPE ECHO**

A digital simulation that provides an realistic reproduction of the classic tape echo.

- **TIME Knob**

Sets the delay time (from the time of the original sound to the time of the delay).

** Just as in the DELAY effect, tapping on the BANK switch can set the TIME (Delay Time) parameter.*

- **FEEDBACK knob**

Sets the number of times the effect will repeat.

** Too high of a setting may result in an uncontrolled oscillation of sound. Please use caution.*

- **LEVEL knob**

Controls the volume of the source signal into the Tape Echo circuit.

** If the same Tape Echo setting is switched from a patch using a LEVEL other than "0" to a patch using a LEVEL of "0", the remaining Tape Echo will be leftover. Of course, the sound of the new patch will not be affected by the Tape Echo.*

Reverb Effects

There are three types of digital reverb, SPRING, HALL and PLATE.

- **SPRING (Spring Reverb)**

This effect simulates the spring reverb of a vintage guitar amp.

- **REVERB knob**

Controls the volume of the source signal into the Reverb circuit.

- **HALL (Hall Reverb)**

This effect simulates the reverb of a hall.

- **REVERB knob**

Controls the volume of the source signal into the Reverb circuit.

- **PLATE (Plate Reverb)**

This effect simulates the reverb of a metal plate.

- **REVERB knob**

Controls the volume of the source signal into the Reverb circuit.

** If the same Reverb type is switched from a patch using a LEVEL other than "0" to a patch using a LEVEL of "0", the remaining Reverb will be leftover. Of course, the sound of the new patch will not be affected by the Reverb.*

External Control Settings

Connecting an optional foot controller (expression pedal) such as the YAMAHA FC-7 to the EXP. PEDAL jack lets you control the volume and tone of the DG-Stomp and effect parameters (value settings). It is also possible to control these parameters with MIDI control changes.

■ Procedure

1. In the Play Mode, simultaneously press the [MANUAL] button and the [UTILITY] button.

Enter the external control setting mode and "E L L" will appear on the display.

2. Press the [COMP] button.

A control number will appear on the display.

Use the [UP]/[DOWN] buttons to set the control number.

Up to 8 programmed control settings can be assigned to control numbers 1-8 in the DG-Stomp. A separate controller can be used to control each programmed control setting or a single controller can be used to control all control settings separately.

3. Press the [CHORUS] button.

The controller type will appear in the display.

Use the [UP]/[DOWN] buttons to set the type of controller.

- *EP* : Control is by the foot controller connected to the EXP. PEDAL jack.

- *1-31, 64-95* : Control is by control change data received from an external MIDI device connected to the MIDI IN jack. Select the control change number. (Refer to the Owner's Manual for the external MIDI device for information in MIDI control change numbers.)

4. Press the [FLANGER] button.

The type of parameter will appear in the display.

Use the [UP]/[DOWN] buttons to select the parameter to be controlled.

- *UUH* : Use as a wah pedal.
- *bPr* : Volume (pre preamp.)
- *APr* : Volume (post preamp.)
- *RrE* : Volume (post reverb)

- *tRE* : Tone Control (TREBLE)
- *mid* : Tone Control (MIDDLE)
- *bBS* : Tone Control (BASS)
- *PRE* : Tone Control (PRESENCE)
- *CP* : Compressor Effect's COMP setting
- *SPd* : Modulation Effect's SPEED setting
- *dPt* : Modulation Effect's DEPTH setting
- *SP2* : The secondary parameter of the Modulation Effect's SPEED knob
- *dP2* : The secondary parameter of the Modulation Effect's DEPTH knob
- *t* : Delay Effect's TIME setting
- *Fb* : Delay Effect's FEEDBACK setting
- *LE* : Delay Effect's LEVEL setting
- *rE* : Reverb Effect's LEVEL setting
- *OFF* : Off (no control)

These parameters (setting values) can be controlled using the controller that is set in step 3.

5. Press the [PHASER] button.

Sets the controller's minimum parameter value.

Use the [UP]/[DOWN] buttons to set the value (0.0-10.0)

6. Press the [ROTARY] button,

Sets the controller's maximum parameter value.

Use the [UP]/[DOWN] buttons to set the value (0.0-10.0).

7. Press the [UTILITY] button to return to the Play Mode.

These external control settings are included in the patch data.

Also, in the Utility settings, there is a function not related to patch settings that sets the External Controller's Operating Mode. The External Controller can be set to operate Globally, by Program (patch) or always OFF. (→ page 25)

Tuner Mode

This mode is used for tuning your guitar. In the Tuner Mode, the DG-Stomp works as a chromatic tuner.

How to Enter the Tuner Mode

To enter the Tuner Mode, use any one of the methods described below.

- Simultaneously press the [UTILITY] button and the [STORE] button.
- In the Play Mode, hold the BANK switch until “**LU**” appears on the display. (The Tuner Mode comes after the Bank Select Mode.)
- In the Bank Select Mode, hold the BANK switch until “**LU**” appears on the display.

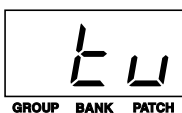

In the Tuner Mode, each of the DG-Stomp's outputs (OUTPUT, PHONES, DIGITAL OUT) will be muted (does not produce any sound).

Tuning

The name of the note closest to that which you played will appear in the display, and five lamps will be used to indicate whether the note's pitch is high, low or correct.

1. To change the standard pitch, use the [UP]/[DOWN] buttons. (Refer to “Setting the Standard Pitch”.)
2. Play the note you want to tune (play only a single note).

At first, tune the guitar so that the note name of the note you want to tune to appears in the display.

Notes are displayed as follows.

A	B \flat	C	D \flat	D	E \flat	E	F	G \flat	G	A \flat
R	b \flat	c	d \flat	d	e \flat	e	f	g \flat	g	a \flat

When the pitch is low, the CHORUS and FLANGER lamps will light. When the pitch is high, the ROTARY and TREMOLO lamps will light. Tune the note until only the PHASER lamp lights. Tuning is complete. (At this time the BANK switch's lamp will also light.)

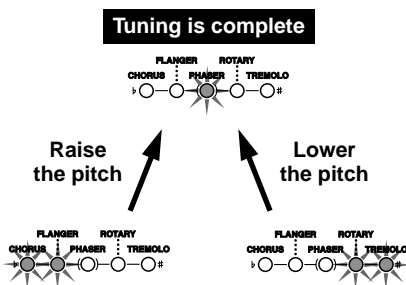

3. Press the [UTILITY] button or the BANK switch to return to the Play Mode.

Setting the Standard Pitch

Usually the standard pitch is set to A-440Hz, there are some cases in which the standard pitch of an acoustic piano, etc. is not 440Hz. The standard pitch of the DG-Stomp can be set anywhere from 436Hz to 444Hz.

1. In the Tuner Mode, press the [UP] button or the [DOWN] button and the standard pitch will appear on the display.

** When the DG-Stomp's power is switched ON, the standard pitch is set to 440Hz.*

2. Every time the [UP] button is pressed the standard pitch will increase by 1Hz. Likewise, every time the [DOWN] button is pressed the standard pitch will decrease by 1Hz.

Utility Mode

The Utility Mode is used for settings that cover the overall system of the DG-Stomp such as the foot switch, MIDI, external control, EXP. PEDAL jack, etc.

■ About the Utility Mode

Press the [UTILITY] button to enter the Utility Mode (the lamp lights).

In the Utility Mode, press the [UTILITY] button to return to the Play Mode (the lamp is off).

In the Utility Mode, MIDI messages cannot be received. Use the Play Mode to receive MIDI messages.

In the Utility Mode, it is possible to set the following seven functions. The Amp Select Switch is used to select the function.

- **LEAD1: Foot Switch Functions**
- **LEAD2: MIDI Functions**
- **DRIVE1: External Control Settings**
- **DRIVE2: EXP. Pedal Settings**
- **CRUNCH1: Wah Pedal Settings**
- **CRUNCH2: Speaker Simulator Mode**
- **CLEAN1: ON/OFF Settings for the Pre Amp Circuit**

■ Foot Switch Functions

Press the [UTILITY] button and set the amp select switch to LEAD1 (“F.5” will appear).

● Select the Foot Switch function

Press the [COMP] button and use the [UP]/[DOWN] buttons to set the function of foot switches 1-3.

- $P_r \bar{C}$: Switch patches with the Foot Switch.
- $\bar{E} \bar{F} \bar{F}$: Switch the effects ON/OFF with the Foot Switch.
 - Switch 1: Modulation Effect
 - Switch 2: Delay Effect
 - Switch 3: Reverb Effect

● Transmitting Control Change Numbers.

Sets the MIDI control change number that is transmitted when the foot switch is switched ON/OFF. (Available only when the Foot Switch function is set to “ $\bar{E} \bar{F} \bar{F}$ ”.)

Press the [CHORUS] button to display the value of the currently selected setting.

Press the Foot Switch that you want to set (the lamp lights), and use the [UP]/[DOWN] buttons to set to one of the following.

- $\bar{O} \bar{F} \bar{F}$: MIDI data is not transmitted.
- $1-32, 64-95$: The control change number that is to be transmitted.

● Transmitting control change values when the switch is OFF.

Sets the MIDI control change value that is transmitted when the Foot Switch is switched OFF. (Available only when the Foot Switch function is set to “ $\bar{E} \bar{F} \bar{F}$ ”.)

Press the [FLANGER] button to display the value of the currently selected setting.

Press the Foot Switch you want to set (the lamp lights), and use the [UP]/[DOWN] buttons to set.

- $\bar{C} - 127$: The control change value that is transmitted.

● Transmitting control change values when the switch is ON.

Sets the MIDI control change number that is transmitted when the Foot Switch is switched ON. (Available only when the Foot Switch function is set to “ $\bar{E} \bar{F} \bar{F}$ ”.)

Press the [PHASER] button to display the value of the currently selected setting.

Press the Foot Switch you want to set (the lamp lights), and use the [UP]/[DOWN] buttons to set.

- $\bar{C} - 127$: The control change value that is transmitted.

Utility Mode

■ MIDI Functions

Press the [UTILITY] button and set the Amp Select switch to LEAD2 (“*lead*” will appear).

● Create a MIDI Program Change Receive Table

Sets the corresponding patch that will be recalled when a MIDI Program Change No. (referred to as PRG No. from here on) is received.

Press the [COMP] button to set the receiving MIDI PRG No. Use the [UP]/[DOWN] buttons to select the number.

- *1-128* : MIDI Program Change No.

Press the [CHORUS] button to set the DG-Stomp's patch number. Just as in selecting a patch in the Play Mode, use the [UP]/[DOWN] buttons or the footswitch.

- *011-933, 011-933* :

The patch number to be recalled.

● Create a MIDI Program Change Transmit Table

When a footswitch (1-3) is pressed to recall a patch a MIDI Program Change Number can be transmitted from the DG-Stomp's MIDI OUT jack to a control an external effector, etc. from the DG-Stomp. Assigns to the patch, a MIDI PRG No. that will be transmitted when the patch is recalled.

Press the [FLANGER] button to set the DG-Stomp's patch number. Just as in selecting a patch in the Play Mode, use the [UP]/[DOWN] buttons or the footswitch.

- *011-933, 011-933* :

The patch number to be recalled.

Press the [PHASER] button to set the MIDI PRG No. to be transmitted. Use the [UP]/[DOWN] buttons to select the number.

- *1-128* : MIDI Program Change No.

● Set the MIDI Receive Channel

Sets the DG-Stomp's MIDI Receive Channel. The MIDI channel set in this step is also used as the device number for the bulk receive function.

Press the [ROTARY] button and use the [UP]/[DOWN] buttons to set the MIDI receive channel.

- *OFF* : MIDI messages are not received
- *ALL* : MIDI messages from all channels are received
- *1-16* : MIDI channel over which messages are received.

● Set the MIDI Transmit Channel

Sets the DG-Stomp's MIDI Transmit Channel. The MIDI channel set in this step is also used as the device number for the bulk out function.

Press the [TREMLO] button and use the [UP]/[DOWN] buttons to set the MIDI transmit channel.

- *1-16* : MIDI channel over which messages are transmitted.

● ON/OFF Setting for MIDI Merge

Sets whether or not the MIDI signal that is received via the DG-Stomp's MIDI IN jack will also be retransmitted via the MIDI OUT jack.

Press the [DELAY] button and use the [UP]/[DOWN] buttons to set the merge setting.

- *ON* : Data is retransmitted via the MIDI OUT jack
- *OFF* : Data is not retransmitted via the MIDI OUT jack

** When the merge is on, data retransmitted via the MIDI OUT jack is not confined to the MIDI Receive Channel setting, so all data from all channels will be transmitted.*

● MIDI Bulk Out

This operation transmits data stored in the DG-Stomp's USER AREA as well as Utility Mode settings to an external device, such as the YAMAHA MDF3, etc., for back up or storage.

Use a MIDI cable to connect the DG-Stomp's MIDI OUT jack to the MIDI IN jack of an external MIDI device.

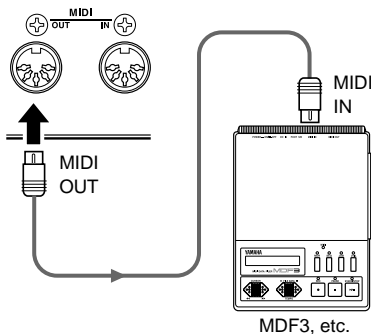

To send all USER AREA data (011-933) plus Utility settings with the Bulk Out operation.

Press the [TAPE ECHO] button (“*ALL*” will appear on the display), then press the [STORE] button to carry out the MIDI Bulk Out.

To send a single USER AREA patch (data) with the Bulk Out operation.

After pressing the [SPRING] button, select the patch number you want to send with the bulk out. Just as in selecting a patch number in the Play Mode, use the [UP]/[DOWN] buttons or the foot switches to select the patch.

After selecting a patch, press the [STORE] button to carry out the MIDI Bulk Out operation with a single patch.

** After transmitting the data the device will return to the previous condition, ready to select another patch number.*

● About the MIDI Bulk In

This operation is used to return data stored in an external MIDI device such as the YAMAHA MDF3, etc., to the DG-Stomp.

Use a MIDI cable to connect the MIDI OUT jack on the external MIDI device to the DG-Stomp's MIDI IN jack.

When Bulk Out data is sent from the external device, the DG-Stomp will receive the bulk data.

** Use the DG-Stomp's Play Mode to receive MIDI Bulk In data.*

When the MIDI Bulk In is carried out, the contents of the patches in the USER AREA will be rewritten.

Please make sure any important data is saved before carrying out the MIDI Bulk In operation.

■ External Control Settings

Just as in the [External Control Settings] section on page 21, these settings are used to control the DG-Stomp's volume, tone and effect parameters from a foot controller that is connected to the EXP. PEDAL jack or a MIDI device that is connected to the MIDI In jack.

Press the [UTILITY] button then set the Amp Select switch to DRIVE1 ("L L L" will appear on the display).

● External Control's Operating Mode Setting

Press the [COMP] button and use the [UP]/[DOWN] buttons to select an Operating Mode for the external control.

- ULb : The external control setting in the Utility Mode is always available.
- PrU : The external control setting that is set in the patch is available.
- OFF : The external control is always OFF.

● Set the External Control Number

Press the [CHORUS] button and use the [UP]/[DOWN] buttons to set a control number (1-8).

** Refer to [External Control Settings] (page 21)*

● Set the External Controller

Press the [FLANGER] button and use the [UP]/[DOWN] buttons to select the type of controller (EP, 1-3, 4-95).

** Refer to [External Control Settings] (page 21)*

● Set the Parameter to be Controlled

Press the [PHASER] button and use the [UP]/[DOWN] buttons to select the parameter to be controlled (UHH-).

** Refer to [External Control Settings] (page 21)*

● Set the Parameter's Minimum Value

Press the [ROTARY] button and use the [UP]/[DOWN] buttons to set the parameter's minimum value (the parameter's value when the controller is set to its minimum: 0.0 - 10.0).

** Refer to [External Control Settings] (page 21)*

● Set the Parameter's Maximum Value

Press the [TREMLOLO] button and use the [UP]/[DOWN] buttons to set the parameter's maximum value (the parameter's value when the controller is set to its maximum: 0.0 - 10.0).

** Refer to [External Control Settings] (page 21)*

Utility Mode

■ EXP Pedal Settings

These settings are available when the EXP Pedal (“EXP”) is selected as the controller in the External Control Settings.

Press the [UTILITY] button then set the amp select switch to DRIVE2 (“EXP” will appear on the display).

● Set the Minimum Value of the EXP Pedal

Sets the minimum value that indicates the position of the EXP Pedal.

Press the [COMP] button and use the [UP]/[DOWN] buttons to set the position (0-128).

You can also hold the [COMP] button and move the EXP Pedal to set the position.

* Due to the relationship between the maximum and minimum value, a value which results in a practical range (refer to the illustration below) of less than 128 can not be used.

● Set the Maximum Value of the EXP Pedal

Sets the maximum value that indicates the position of the EXP Pedal.

Press the [CHORUS] button and use the [UP]/[DOWN] buttons to set the position (127-255).

You can also hold the [CHORUS] button and move the EXP Pedal to set the position.

* Due to the relationship between the maximum and minimum value, a value which results in a practical range (refer to the illustration below) of less than 128 can not be used.

* The value can not be set greater than that of the EXP Pedal's Switch Setting.

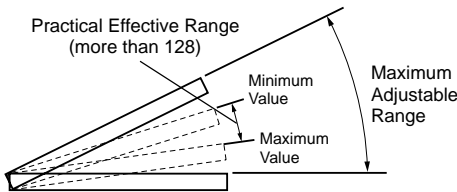

● The EXP Pedal's Switch Setting

When the EXP Pedal is used as a wah pedal, it is possible to switch the wah effect ON/OFF by stepping on the pedal. Set the pedal angle at which the effect is switched ON/OFF.

Press the [FLANGER] button and use the [UP]/[DOWN] buttons to set the pedal position.

You can also hold the [FLANGER] button and move the EXP Pedal to set the position.

* The value can not be set less than that of the EXP Pedal's Maximum Value.

* If the value is set to “OFF”, the wah switch function will be ineffective.

* The YAMAHA FC-7 foot controller is equipped with a “fortissimo” function that allows the foot pedal to be depressed beyond its average position. When your foot releases the fully depressed pedal, the pedal will naturally return to its average position. Setting the EXP Pedal's switch function to this “fortissimo” function is convenient.

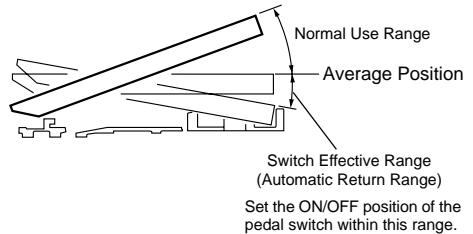

● Transmitting Control Change Numbers from the EXP Pedal

Set the MIDI control change number that is to be transmitted when the EXP pedal is used.

Press the [PHASER] button and use the [UP]/[DOWN] buttons to set the control change number.

- OFF : MIDI is not transmitted
- 1-32, 64-95 :

Control change number that is to be transmitted.

■ Wah Pedal Settings

These settings are available when the Wah Pedal function (“*WUH*”) is selected as the controller in the External Control settings.

Press the [UTILITY] button then set the amp select switch to CRUNCH1 (“*WUH*” will appear on the display).

● Set the Low Frequency of the Wah Pedal

Sets the low frequency in the wah pedal's frequency range.

Press the [COMP] button and use the [UP]/[DOWN] buttons to set the frequency (*150-500*:Hz).

● Set the High Frequency of the Wah Pedal

Sets the high frequency in the wah pedal's frequency range.

Press the [CHORUS] button and use the [UP]/[DOWN] buttons to set the frequency (*1.50-5.00*:kHz).

● Set the Wah Pedal “Q”

Sets the frequency curve of the wah pedal.

Press the [FLANGER] button and use the [UP]/[DOWN] buttons to select a curve (*100-500*).

■ The Speaker Simulator

Press the [UTILITY] button then set the amp select switch to CRUNCH2. The current setting will appear on the display.

Use the [UP]/[DOWN] buttons to select a speaker simulator mode.

- *On* : The speaker simulator is always ON.
- *PrG* : The speaker simulator is switched ON/OFF according to the patch setting.
- *Off* : The speaker simulator is always OFF

■ Preamp Circuit ON/OFF Settings

When the DG-Stomp's preamp circuit is not used, it is possible to use the DG-Stomp as an effector or a MIDI foot controller.

Press the [UTILITY] button then set the amp select switch to CLEAN1.

Use the [UP]/[DOWN] buttons to set the preamp circuit ON/OFF.

- *On* : The preamp circuit is active (in use)
- *Off* : The preamp circuit is inactive (not in use)

Error Messages

If an error occurs during operation, one of the following error message numbers will appear on the display.

E 1: MIDI Receive Buffer Full

CAUSE: Too much MIDI data is being received by the DG amplifier at one time.

SOLUTION: Try reducing the amount of data being sent or, break the data into smaller blocks.

E 2: Communication Error.

CAUSE: An abnormality is detected during MIDI communications.

SOLUTION: Check all connections, etc. and try again.

E 3: Bulk Receive Check Sum Error.

CAUSE: The check sum does not match the received MIDI bulk data.

SOLUTION: Check all connections and data, and try again.

E 4: Bulk Receive Data Abnormality.

CAUSE: An abnormality is detected in the received MIDI bulk data.

SOLUTION: Check all connections and data, and try again.

E 5: Backup Battery Error.

CAUSE: Backup battery power is depleted.

SOLUTION: Continued use of the device will result in the loss of data. Return the device to the music dealer where you purchased it or, the nearest Yamaha Service center and have the battery replaced.

Trouble Shooting

No Sound

- Is the power adaptor properly connected?
- Is the volume level on the guitar amplifier turned up?
- Is the GAIN knob value set to "0"?
- Is the MASTER knob value set to "0"?
- Is the OUTPUT knob value set to "0"?
- If an EXP pedal is being used to control the volume, try stepping on the pedal.
- Is the Tuner Mode active? Press the [UTILITY] button or the BANK switch to return to the Play Mode.

Turning the Knobs Does Not Change the Sound

- Turn the knob until the value in the display changes, then adjust the setting. (→ page 13).

- Is that knob's effect switched ON? After selecting the effect, by pressing the effect button, turn the knob to adjust the setting. (→ page 13)

Can Not Transmit MIDI

- Is the MIDI channel matched with MIDI channel on the receiving device? (→ page 24)
- Is the MIDI Merge set to "OFF"? (→ page 24)

Can Not Receive MIDI

- Is the DG-Stomp in the Play Mode? Return to the Play Mode and try receiving again.
- Is the DG-Stomp's MIDI channel set to "OFF"? (→ page 24)

Specifications

Digital Section

- Full Digital Signal Processing
- 8 Channel Preamp
- Digital Effects
 - Compressor
 - Chorus, Flanger, Phaser, Rotary Speaker, Tremolo
 - Digital Delay, Tape Echo
 - Spring Reverb, Hall Reverb, Plate Reverb
- Tap Tempo Function (Delay Time)
- Speaker Simulator (16 Types)
- External Controller Function (EXP Pedal/MIDI):8 Controllers/Parameters
- Wah Function
- Tuner Function (Chromatic, Auto)

MIDI Functions

Receive: Program Change (Program Change Table can be created), Control Change, Bulk In
Transmit: Program Change, Control Change, Bulk Out, Merge Out

Controller Switch

Top Panel

Push Switch x17

UP, DOWN, MANUAL, UTILITY, STORE, COMP, CHORUS, FLANGER, PHASER, ROTARY, TREMOLO, DELAY, TAPE ECHO, SPRING, HALL, PLATE, SP. SIM

Knob x15

AMP SELECT, GAIN, MASTER, TREBLE, MIDDLE, BASS, PRESENCE, COMP, SPEED, DEPTH, TIME, FEEDBACK, LEVEL, REVERB, OUTPUT

Footswitch x4

1, 2, 3, BANK

Rear Panel

STAND-BY ON/OFF, INPUT LOW/HIGH

Display

7 Segment LED (3 digit) x1

Push Switch LED x17

Foot Switch LED x4

Connections/Jacks

INPUT: Standard Monaural Phone Jack

OUTPUT L/MONO, R: Standard Monaural Phone Jack

PHONES: Standard Stereo Phone Jack

EXP. PEDAL: Standard Stereo Phone Jack

DIGITAL OUT: COAXIAL

MIDI IN, MIDI OUT: 5 pin DIN

A/D Converter

20 bit + 3 bit Floating

D/A Converter

20 bit

Sampling Frequency

48 kHz

Memory Allocations

Preset: 90

User: 90

Input Level/Impedance

(When using preamp bypass)

INPUT HIGH: -25dBm/1M Ω

INPUT LOW: -15dBm/1M Ω

Output Level/Impedance

OUTPUT L/MONO, R: 0dBm/1k Ω

PHONES: 0dBm/47 Ω (47 Ω load)

Power

Exclusive Power Adaptor (AC-10)

AC Output: AC12V, 1000mA

Power Consumption

15W

Dimensions (WxHxD)

280x70x184mm (11.0"x2.8"x7.2")

Weight

2.2kg (4lbs 14oz)

Accessories

Power Adaptor (AC-10)

Owner's Manual (this booklet)

* Specifications and design may change without notice.

MIDI Implementation Chart

YAMAHA [Guitar Pre Amplifier with Multi Effects] Date:30-Jun-2000
 Model DG stomp MIDI Implementation Chart Version : 1.0

Function ...	Transmitted	Recognized	Remarks
Basic Default	1 - 16	1 - 16, off	memorized
Channel Changed	1 - 16	1 - 16, off	
Default	1, 3	1, 3	memorized
Mode Messages	x	x	
Altered	*****	x	
Note	x	x	
Number : True voice	*****	x	
Velocity Note ON	x	x	
Note OFF	x	x	
After Key's	x	x	
Touch Ch's	x	x	
Pitch Bender	x	x	
0	x	x	
1 - 31	o	o	
32 - 63	x	x	
64 - 95	o	o	
Control 95 -127	x	x	
Change			

MIDI Implementation Chart

Prog	0	0 - 127	0	0 - 127
Change : True #	*****	*****	*****	*****
System Exclusive	0		0	Bulk Dump
System : Song Pos.	x		x	
System : Song Sel.	x		x	
common : Tune	x		x	
System : Clock	x		x	
Real Time : Commands	x		x	
Aux : All Sound OFF	x		x	
Reset All Cntrls	x		x	
Local ON/OFF	x		x	
All Notes OFF	x		x	
Mes- : Active Sense	0		x	
sages:Reset	x		x	
Mode 1	OMNI ON,	POLY	Mode 2	OMNI ON, MONO
Mode 3	OMNI OFF,	POLY	Mode 4	OMNI OFF, MONO
				o : Yes
				x : No

