

YAMAHA RX-495/395

Natural Sound Stereo Receiver

Ampli-sintoniseur stéréo de la série "Natural Sound"

Receptor estéreo de Sonido Natural

Thank you for selecting this YAMAHA stereo receiver.

Nous vous remercions pour avoir porté votre choix sur ce récepteur stéréo YAMAHA.

Muchas gracias por haber adquirido este receptor estéreo YAMAHA.



**OWNER'S MANUAL
MODE D'EMPLOI
MANUAL DE INSTRUCCIONES**

SAFETY INSTRUCTIONS

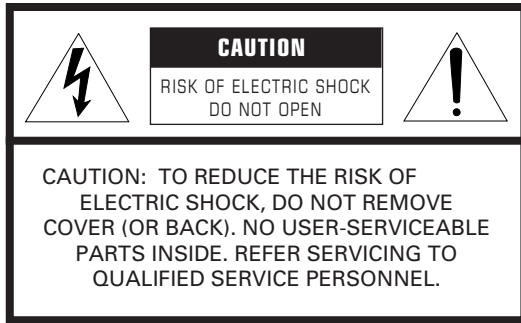

• Explanation of Graphical Symbols

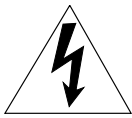

The lightning flash with arrowhead symbol, within an equilateral triangle, is intended to alert you to the presence of uninsulated "dangerous voltage" within the product's enclosure that may be of sufficient magnitude to constitute a risk of electric shock to persons.



The exclamation point within an equilateral triangle is intended to alert you to the presence of important operating and maintenance (servicing) instructions in the literature accompanying the appliance.



- 1 Read Instructions – All the safety and operating instructions should be read before the unit is operated.
- 2 Retain Instructions – The safety and operating instructions should be retained for future reference.
- 3 Heed Warnings – All warnings on the unit and in the operating instructions should be adhered to.
- 4 Follow Instructions – All operating and other instructions should be followed.
- 5 Water and Moisture – The unit should not be used near water – for example, near a bathtub, washbowl, kitchen sink, laundry tub, in a wet basement, or near a swimming pool, etc.
- 6 Carts and Stands – The unit should be used only with a cart or stand that is recommended by the manufacturer.
- 6A A unit and cart combination should be moved with care. Quick stops, excessive force, and uneven surfaces may cause the unit and cart combination to overturn.
- 7 Wall or Ceiling Mounting – The unit should be mounted to a wall or ceiling only as recommended by the manufacturer.
- 8 Ventilation – The unit should be situated so that its location or position does not interfere with its proper ventilation. For example, the unit should not be situated on a bed, sofa, rug, or similar surface, that may block the ventilation openings; or placed in a built-in installation, such as a bookcase or cabinet that may impede the flow of air through the ventilation openings.
- 9 Heat – The unit should be situated away from heat sources such as radiators, stoves, or other appliances that produce heat.
- 10 Power Sources – The unit should be connected to a power supply only of the type described in the operating instructions or as marked on the unit.
- 11 Power-Cord Protection – Power-supply cords should be routed so that they are not likely to be walked on or pinched by items placed upon or against them, paying particular attention to cords at plugs, convenience receptacles, and the point where they exit from the unit.
- 12 Cleaning – The unit should be cleaned only as recommended by the manufacturer.
- 13 Nonuse Periods – The power cord of the unit should be unplugged from the outlet when left unused for a long period of time.
- 14 Object and Liquid Entry – Care should be taken so that objects do not fall into and liquids are not spilled into the inside of the unit.
- 15 Damage Requiring Service – The unit should be serviced by qualified service personnel when:
 - A. The power-supply cord or the plug has been damaged; or
 - B. Objects have fallen, or liquid has been spilled into the unit; or
 - C. The unit has been exposed to rain; or
 - D. The unit does not appear to operate normally or exhibits a marked change in performance; or
 - E. The unit has been dropped, or the cabinet damaged.
- 16 Servicing – The user should not attempt to service the unit beyond those means described in the operating instructions. All other servicing should be referred to qualified service personnel.
- 17 Power Lines – An outdoor antenna should be located away from power lines.
- 18 Grounding or Polarization – Precautions should be taken so that the grounding or polarization is not defeated.



19 For US customers only:

Outdoor Antenna Grounding – If an outside antenna is connected to this unit, be sure the antenna system is grounded so as to provide some protection against voltage surges and built-up static charges. Article 810 of the National Electrical Code, ANSI/NFPA 70, provides information with regard to proper grounding of the mast and supporting structure, grounding of the lead-in wire to an antenna discharge unit, size of grounding conductors, location of antenna discharge unit, connection to grounding electrodes, and requirements for the grounding electrode.

Note to CATV system installer:

This reminder is provided to call the CATV system installer's attention to Article 820-40 of the NEC that provides guidelines for proper grounding and, in particular, specifies that the cable ground shall be connected to the grounding system of the building, as close to the point of cable entry as practical.

EXAMPLE OF ANTENNA GROUNDING

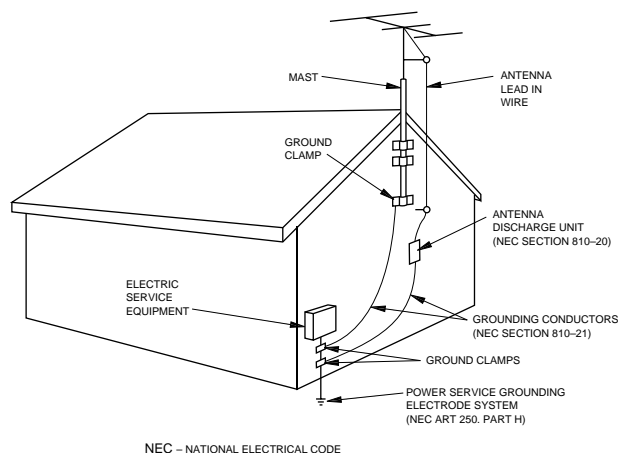
**SPECIAL NOTES FOR FCC COMPOSITE DEVICE (for US customers only)**

This device is a composite system. The digital device component may not cause harmful interference.

FCC INFORMATION (for US customers only)**1. IMPORTANT NOTICE : DO NOT MODIFY THIS UNIT!**

This product, when installed as indicated in the instructions contained in this manual, meets FCC requirements. Modifications not expressly approved by Yamaha may void your authority, granted by the FCC, to use the product.

2. IMPORTANT : When connecting this product to accessories and/or another product use only high quality shielded cables. Cable/s supplied with this product **MUST** be used. Follow all installation instructions. Failure to follow instructions could void your FCC authorization to use this product in the USA.**3. NOTE :** This product has been tested and found to comply with the requirements listed in FCC Regulations, Part 15 for Class "B" digital devices. Compliance with these requirements provides a reasonable level of assurance that your use of this product in a residential environment will not result in harmful interference with other electronic devices.

This equipment generates/uses radio frequencies and, if not installed and used according to the instructions found in the users manual, may cause interference harmful to the operation of other electronic devices.

Compliance with FCC regulations does not guarantee that interference will not occur in all installations. If this product is found to be the source of interference, which can be determined by turning the unit "OFF" and "ON", please try to eliminate the problem by using one of the following measures:

Relocate either this product or the device that is being affected by the interference.

Utilize power outlets that are on different branch (circuit breaker or fuse) circuits or install AC line filter/s.

In the case of radio or TV interference, relocate/reorient the antenna. If the antenna lead-in is 300 ohm ribbon lead, change the lead-in to coaxial type cable.

If these corrective measures do not produce satisfactory results, please contact the local retailer authorized to distribute this type of product. If you can not locate the appropriate retailer, please contact Yamaha Electronics Corp., U.S.A. 6660 Orangethorpe Ave, Buena Park, CA 90620.

The above statements apply **ONLY** to those products distributed by Yamaha Corporation of America or its subsidiaries.

We Want You Listening For A Lifetime (for US customers only)

YAMAHA and the Electronic Industries Association's Consumer Electronics Group want you to get the most out of your equipment by playing it at a safe level. One that lets the sound come through loud and clear without annoying blaring or distortion – and, most importantly, without affecting your sensitive hearing.

Since hearing damage from loud sounds is often undetectable until it is too late, YAMAHA and the Electronic Industries Association's Consumer Electronics Group recommend you to avoid prolonged exposure from excessive volume levels.



FEATURES



- **RX-495**
70W + 70W (8Ω) RMS Output Power,
0.04% THD, 20–20,000 Hz
- **RX-395**
45W + 45W (8Ω) RMS Output Power,
0.04% THD, 20–20,000 Hz
- High Dynamic Power, Low Impedance Drive Capability
- Continuously Variable Loudness Control
- 40-Station Random Access Preset Tuning
- Automatic Preset Tuning
- Preset Station Shifting Capability (Preset Editing)
- IF Count Direct PLL Synthesizer Tuning System
- SLEEP Timer
- Remote Control Capability
- **RX-495 only**
PURE DIRECT Switch to Reproduce the Purest Source Sound

CONTENTS

Safety Instructions.....	2
Features	4
Supplied Accessories	4
Caution	5
Controls and Their Functions	6
Connections	10
Basic Operations	14
Tuning Operations	17
Preset Tuning	18
Notes about the Remote Control Transmitter	21
Troubleshooting	22
Specifications	23

SUPPLIED ACCESSORIES

After unpacking, check that the following parts are contained.

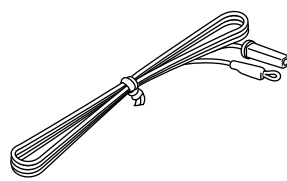
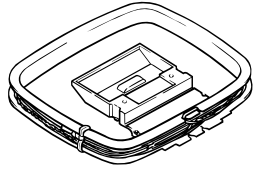
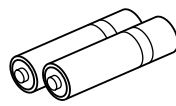
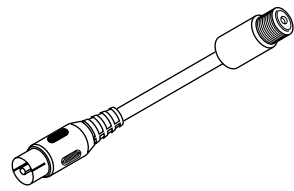
<p>Remote Control Transmitter</p> <div style="display: flex; justify-content: space-around; align-items: center;"> <div style="text-align: center;"> <p>RX-495</p>  </div> <div style="text-align: center;"> <p>RX-395</p>  </div> </div>	<p>Indoor FM Antenna</p> 	<p>AM Loop Antenna</p> 
	<p>Batteries (size AA, R6, UM-3)</p> 	<p>Antenna adapter <U.S.A. and Canada model only></p> 

CAUTION : READ THIS BEFORE OPERATING YOUR UNIT.

- 1 To assure the finest performance, please read this manual carefully. Keep it in a safe place for future reference.
- 2 Install this unit in a cool, dry, clean place – away from windows, heat sources, sources of excessive vibration, dust, moisture and cold. Avoid sources of humming (transformers, motors). To prevent fire or electrical shock, do not expose the unit to rain or water.
- 3 Do not operate the unit upside-down. It may overheat, possibly causing damage.
- 4 Never open the cabinet. If something drops into the set, contact your dealer.
- 5 The openings on the cabinet assure proper ventilation of the unit. If these openings are obstructed, the temperature inside the cabinet will rise rapidly. Therefore, avoid placing objects against these openings, and install the unit in well-ventilated condition. Make sure to allow a space of at least 10 cm behind, on the both sides and above the top panel of the unit. Otherwise it may not only damage the unit, but also cause fire.
- 6 Do not use force on switches, controls or connection wires. When moving the unit, first disconnect the power plug and the wires connected to other equipment. Never pull the wires themselves.
- 7 Do not attempt to clean the unit with chemical solvents; this might damage the finish. Use a clean, dry cloth.
- 8 Always set the VOLUME control to “– ∞” before starting the audio source play. Increase the volume gradually to an appropriate level after the play back has been started.
- 9 To prevent lightning damage, pull out the power cord and remove the antenna cable during an electrical storm.
- 10 Be sure to read the “TROUBLESHOOTING” section regarding common operating errors before concluding that the unit is faulty.
- 11 AC outlet
Do not connect audio equipment to the AC outlet on the rear panel if that equipment requires more power than the outlet is rated to provide.
- 12 **Voltage Selector (General Model only)**
The voltage selector on the rear panel of this unit must be set for your local main voltage BEFORE plugging into the AC main supply.
Voltages are 110–120/220–240V AC, 50/60 Hz.

IMPORTANT

Please record the serial number of this unit in the space below.

Serial No.:

The serial number is located on the rear of the unit. Retain this Owner's Manual in a safe place for future reference.

WARNING

TO REDUCE THE RISK OF FIRE OR ELECTRIC SHOCK, DO NOT EXPOSE THIS UNIT TO RAIN OR MOISTURE.

CAUTION (FOR CANADA MODEL)

TO PREVENT ELECTRIC SHOCK, MATCH WIDE BLADE OF PLUG TO WIDE SLOT AND FULLY INSERT.

FOR CANADIAN CUSTOMER

THIS CLASS B DIGITAL APPARATUS MEETS ALL REQUIREMENTS OF THE CANADIAN INTERFERENCE-CAUSING EQUIPMENT REGULATIONS.

The apparatus is not disconnected from the AC power source as long as it is connected to the wall outlet, even if the apparatus itself is turned off.

FREQUENCY STEP switch (General Model only)

Because the interstation frequency spacing differs in different areas, set the FREQUENCY STEP switch (located at the rear) according to the frequency spacing in your area. Before setting this switch, disconnect the AC power plug of this unit from the AC outlet.

CONTROLS AND THEIR FUNCTIONS

FRONT PANEL

RX-495

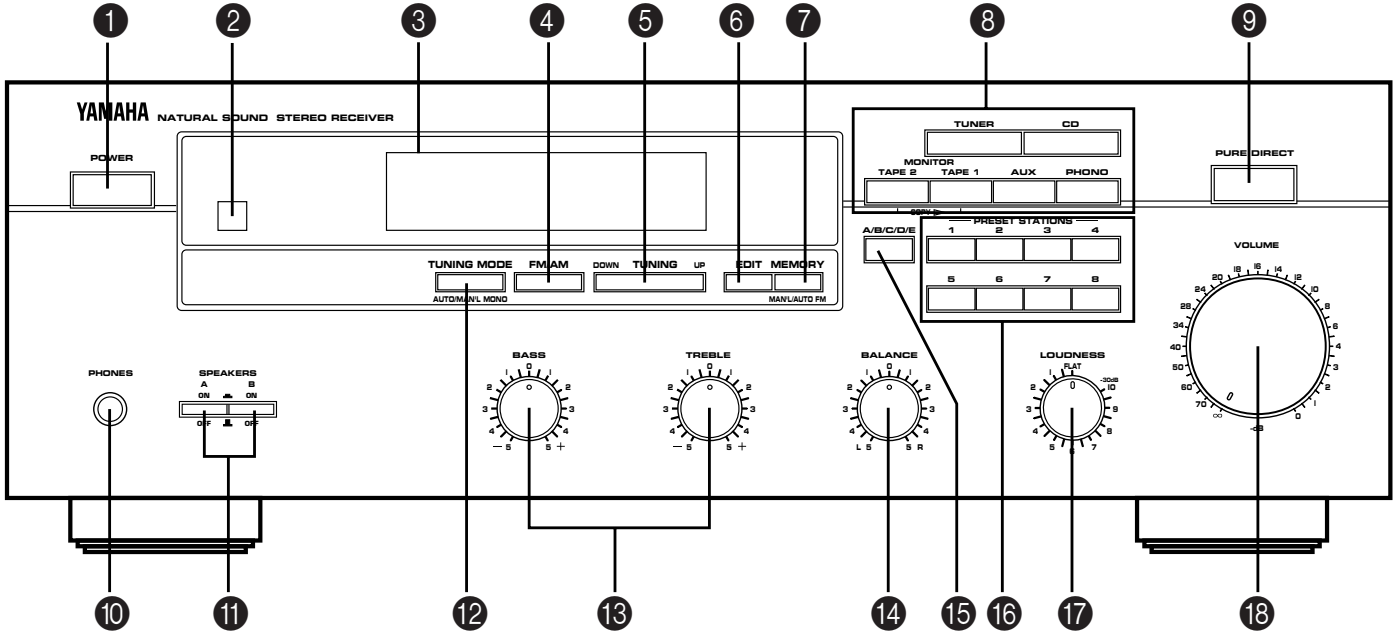

RX-395

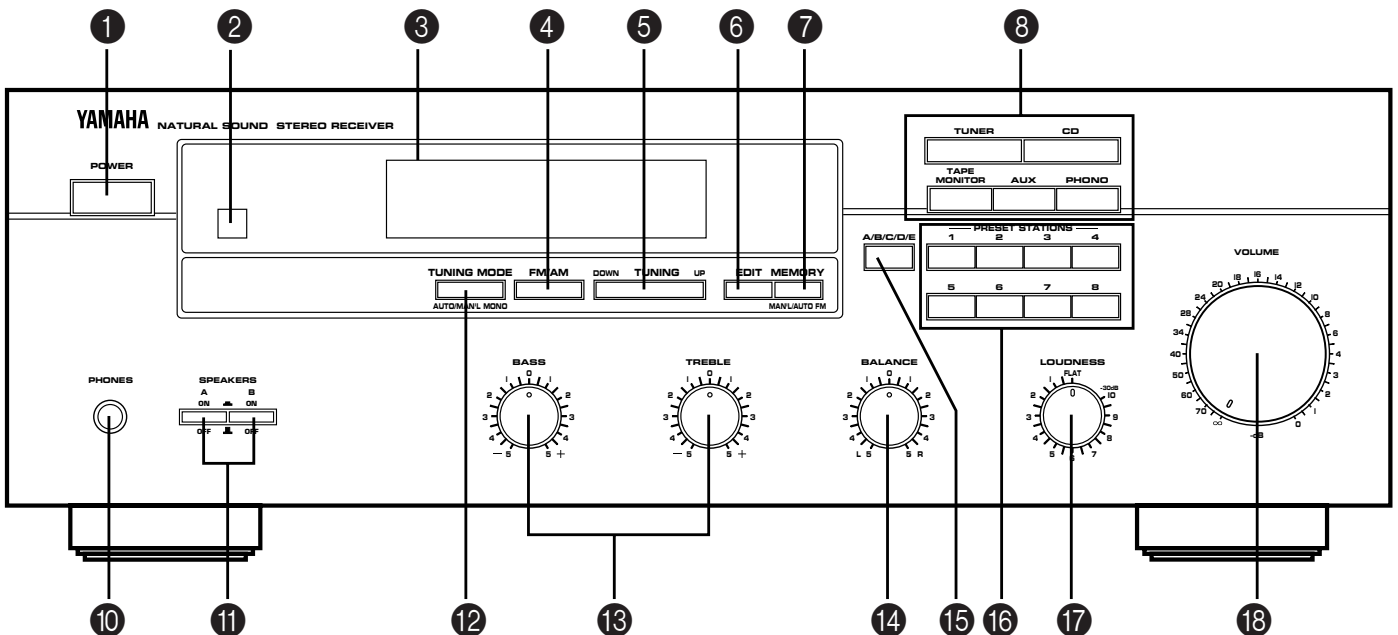

1 POWER switch

Press this switch to switch the power on. Press it again to switch the power off.

* Standby mode <Australia and Singapore models only>

While the power is on, pressing the **POWER** key on the remote control transmitter switches the unit to the standby mode. (In this mode, the power indicator is half illuminated.)

2 Remote control sensor

Receives signals from the remote control transmitter.

3 Display panel

Shows station frequencies and various information. (Refer to the next page for details.)

4 FM/AM buttons

Press this button to switch the reception band to FM or AM.

5 TUNING DOWN/UP button

Used for tuning. Press the "UP" side to tune in to higher frequencies, and press the "DOWN" side to tune in to lower frequencies.

6 EDIT button

This button is used to exchange the places of two preset stations with each other.

7 MEMORY (MAN'L/AUTO FM) button

When this button is pressed, the MEMORY indicator flashes for about 5 seconds. During this period, press the desired **PRESET STATIONS** button to enter the displayed station into the memory.

When this button is pressed and held for about 3 seconds, the automatic preset tuning begins.

8 Input selector buttons

Select a program source to listen to. When a button is pressed, the name of selected source lights up on the display.

9 PURE DIRECT switch **RX-495 only**

Press this switch to listen to a source in the purest sound. (Refer to page 16 for details.)

10 PHONES jack

When you listen with headphones, connect the headphones to the **PHONES** jack. When listening with headphones privately, set both the **SPEAKERS A** and **B** switches to the **OFF** position.

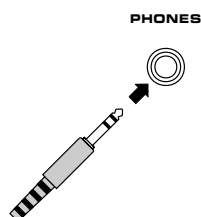
**11 SPEAKERS switches**

Set the switch **A** or **B** (or both **A** and **B**) for the speaker system (connected to this unit) you will use to the **ON** position. Set the switch for the speaker system you will not use to the **OFF** position.

12 TUNING MODE (AUTO/MAN'L) button

Press this button to switch the tuning mode to automatic or manual. To select the automatic tuning mode, press this button so that "AUTO TUNING" lights up on the display. To select the manual tuning mode, press this button so that "AUTO TUNING" goes off.

13 Tone controls**BASS**

Used to increase or decrease the low frequency response. The 0 position produces flat response.

TREBLE

Used to increase or decrease the high frequency response. The 0 position produces flat response.

14 BALANCE control

Adjusts the balance of the output volume to the left and right speakers to compensate for sound imbalance caused by speaker location or listening room conditions.

15 A/B/C/D/E button

Press this button to select a desired group (A–E) of preset stations.

16 PRESET STATIONS buttons

Used to enter as many as 40 station frequencies into the memory.

17 Continuously variable LOUDNESS control

Used to compensate for the human ears' loss of sensitivity to high and low-frequency ranges at low volume.

18 VOLUME control

Used to raise or lower the volume level.

DISPLAY PANEL

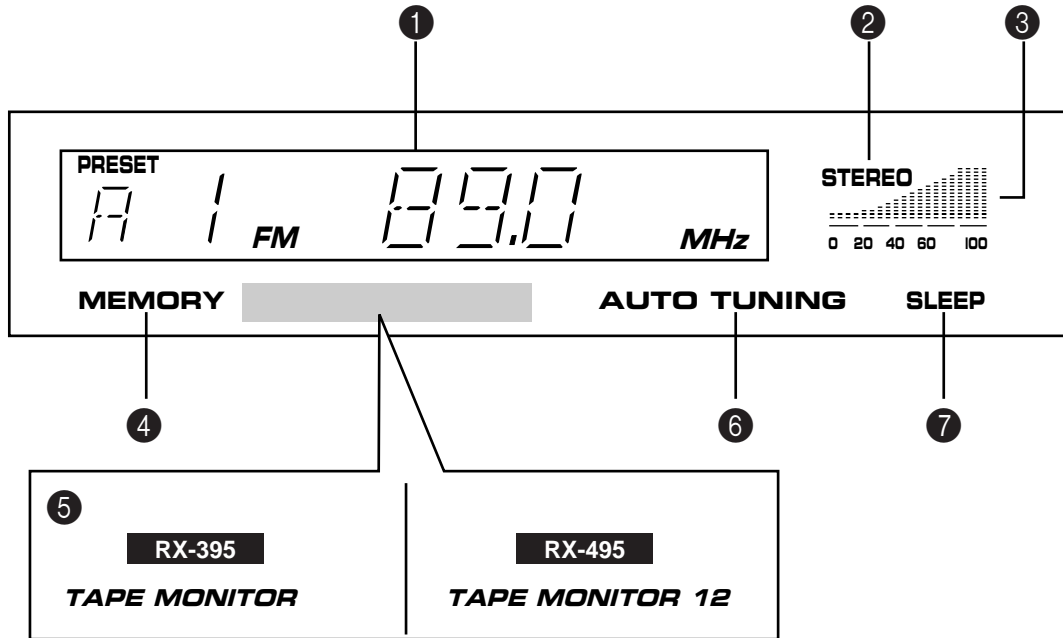

1 Multi-information display

Displays various information, for example station frequency, preset station number and name of selected program source.

2 STEREO indicator

Lights up when an FM stereo broadcast with sufficient signal strength is received.

3 Signal-level meter

Indicates the signal level of the received station. If multipath interference is detected, the indication decreases.

4 MEMORY indicator

When the **MEMORY** button is pressed, this indicator flashes for about 5 seconds. During this period, the displayed station can be programmed to the memory by using the **A/B/C/D/E** button and one of the **PRESET STATIONS** buttons.

5 TAPE MONITOR indicator

RX-395

Lights up when the tape deck is selected as the input source by pressing the **TAPE MONITOR** button.

RX-495

When the first tape deck is selected as the input source by pressing the **TAPE 1** button, "TAPE MONITOR 1" lights up, and when the second tape deck is selected by pressing the **TAPE 2** button, "TAPE MONITOR 2" lights up.

6 AUTO TUNING indicator

This indicator lights up when this unit is in the automatic tuning mode.

7 SLEEP indicator

Lights up while the built-in SLEEP timer is functioning.

REMOTE CONTROL TRANSMITTER

The remote control transmitter provided with this unit is designed to control all the most commonly used functions of the unit. If the CD player and tape deck connected to this unit are YAMAHA components designed for remote control compatibility, then this remote control transmitter will also control various functions of each component.

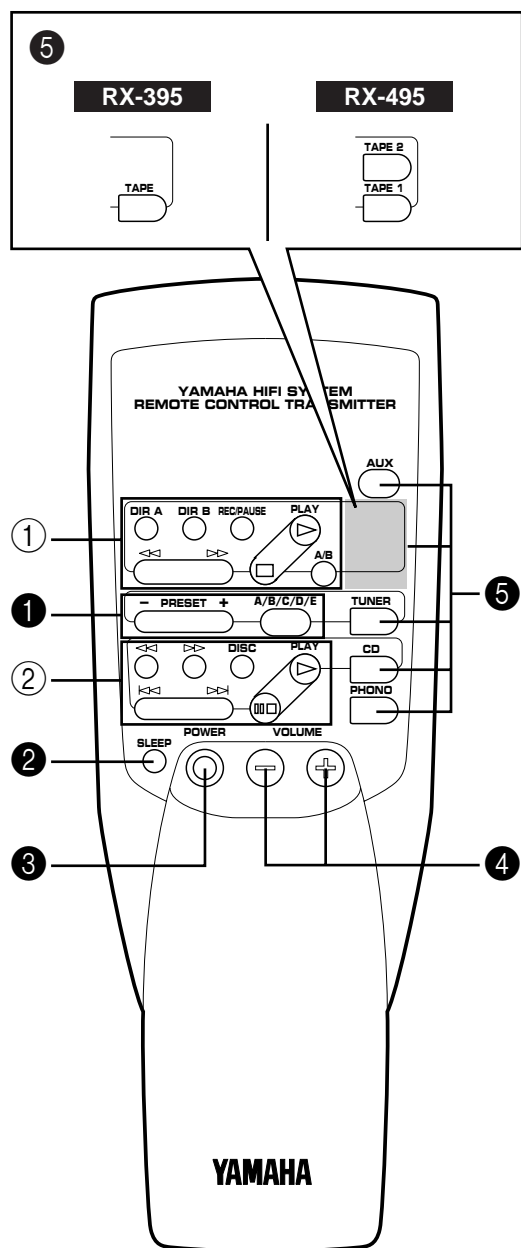

For Control of This Unit

① Tuner keys

Controls tuner.

+: Selects higher preset station number.

-: Selects lower preset station number.

A/B/C/D/E Selects the group (A – E) of preset station numbers.

② SLEEP timer key

The power to this unit is automatically turned off one hour after this key is pressed (so that "SLEEP" lights up on the display).

③ POWER key

Turns the power on/off.

* <Australia and Singapore models only>

While the power is on, pressing the **POWER** key on the remote control transmitter switches the unit from the power-on mode to the standby mode, and vice versa. (In the standby mode, the power indicator on the front panel is half illuminated.)

④ VOLUME +/- keys

Turns the volume level up/down.

⑤ Input selector keys

Selects input source.

For Other Component Control

Identify the remote control transmitter keys with your component's keys. If these keys are identical, their functions will be the same. On each key function, refer to the corresponding instruction on your component's manual.

① Tape deck keys

Controls tape deck.

* **DIR A, B** and **A/B** are applicable only to double cassette tape deck.

* For a single cassette deck with automatic reverse function, pressing **DIR A** will reverse the direction of tape running.

② CD player keys

Controls compact disc player.

* **DISC** is applicable only to compact disc changer.

CONNECTIONS

Before attempting to make any connections to or from this unit, be sure to first switch OFF the power to this unit and to any other components to which connections are being made.

CONNECTIONS WITH OTHER COMPONENTS

When making connections between this unit and other components, be sure all connections are made correctly, that is to say L (left) to L, R (right) to R, “+” to “+” and “-” to “-”. Also, refer to the owner’s manual for each component to be connected to this unit.

- * If you have YAMAHA components numbered as 1, 2, 3, etc. on the rear panel, connections can be made easily by making sure to connect the output (or input) terminals of each component to the same-numbered terminals of this unit.

RX-495

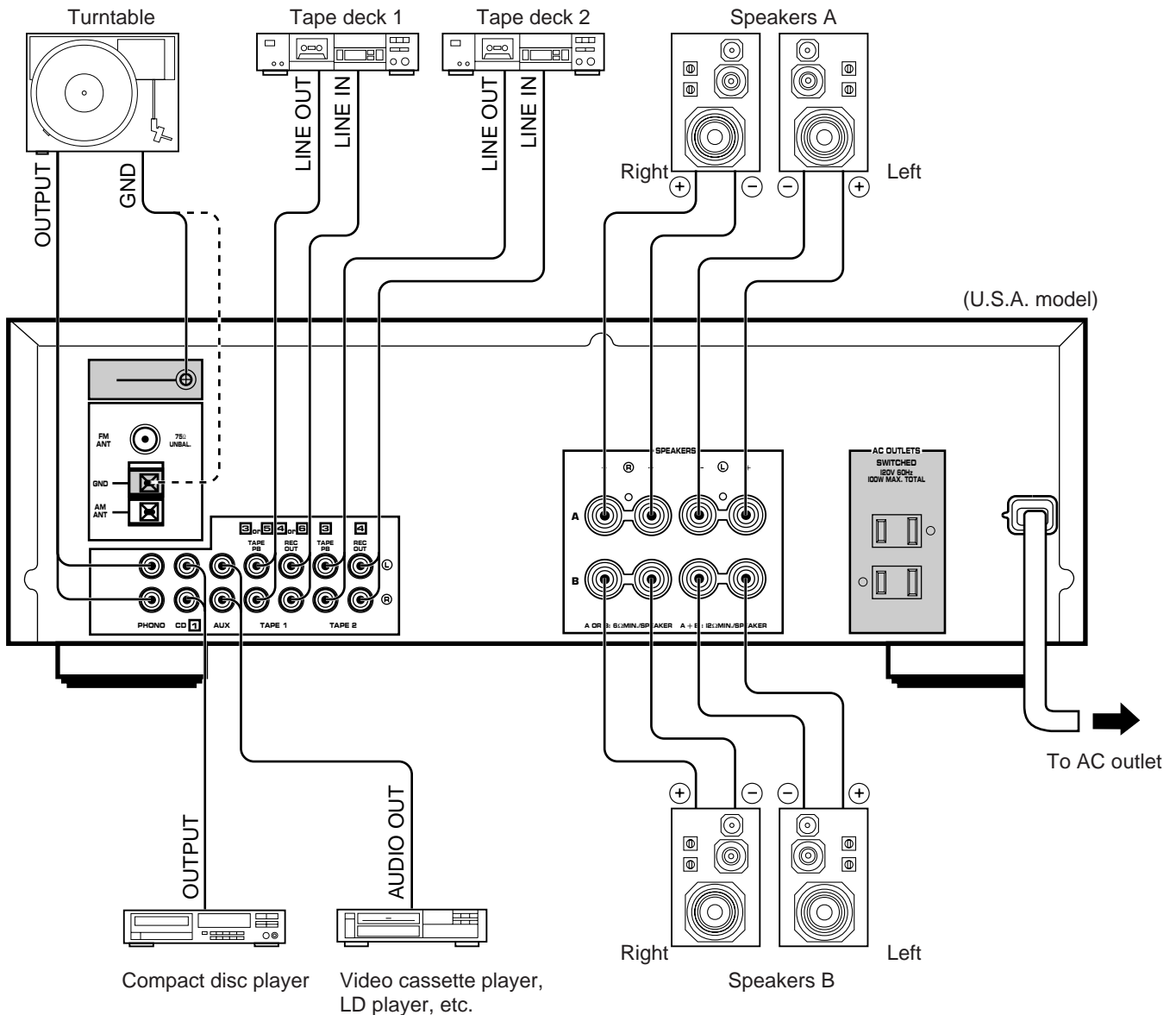

 : Refer to “ABOUT THE ACCESSORY TERMINALS” on page 12.

RX-395

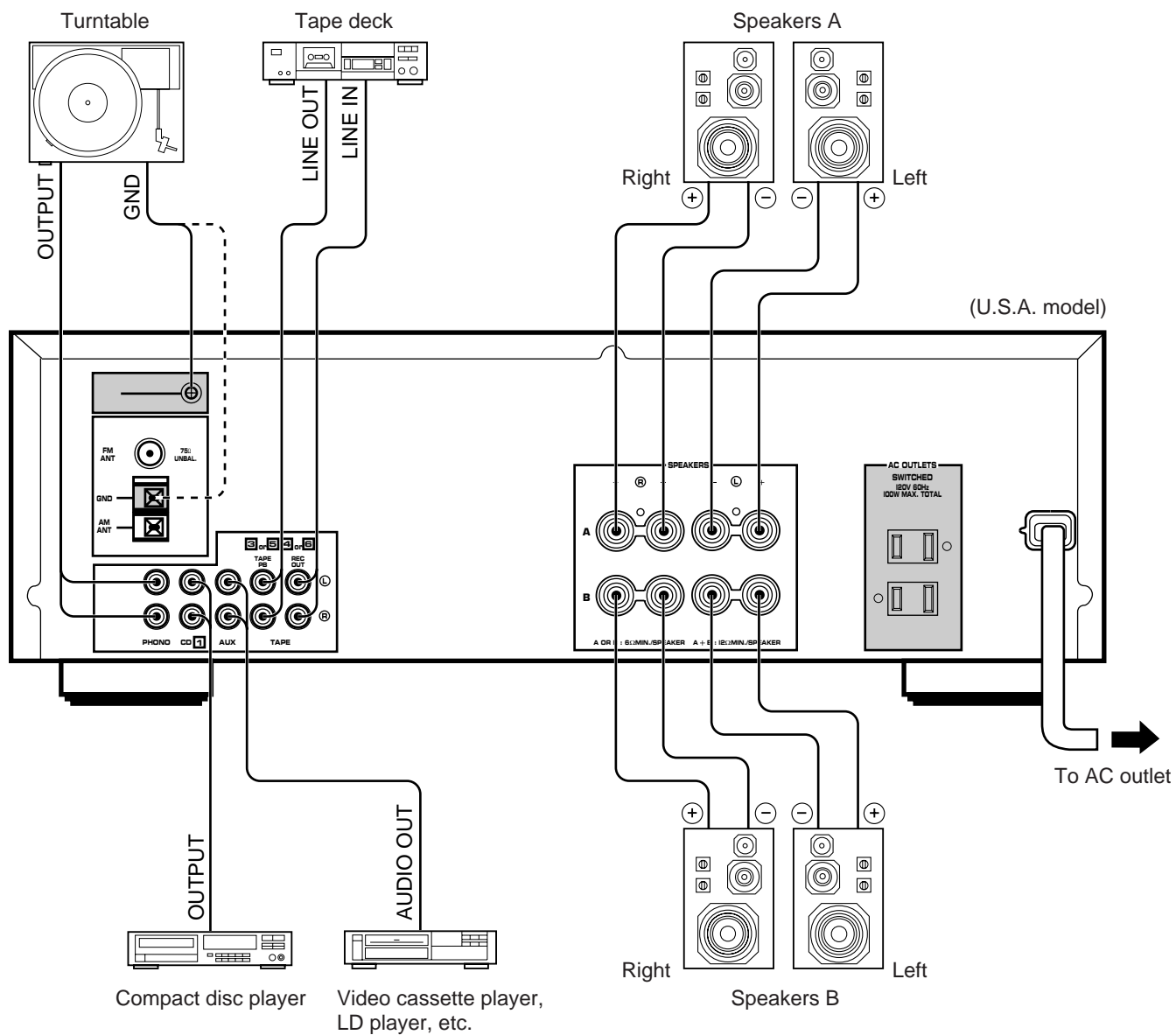

 : Refer to "ABOUT THE ACCESSORY TERMINALS" on page 12.

CONNECTING SPEAKERS

Connect the **SPEAKERS** terminals to your speakers with wire of the proper gauge, cut as short as possible. If the connections are faulty, no sound will be heard from the speakers. Make sure that the polarity of the speaker wires is correct, that is, + and – markings are observed. If these wires are reversed, the sound will be unnatural and will lack bass. **Do not let the bare speaker wires touch each other and do not let them touch the metal parts of this unit as this could damage this unit and/or speakers.**

How to Connect:

Red: positive (+)
Black: negative (–)

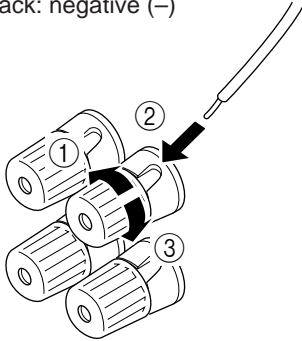

- ① Unscrew the knob.
- ② Insert the bare wire.
[Remove approx. 5mm (1/4") insulation from the speaker wires.]
- ③ Tighten the knob and secure the wire.

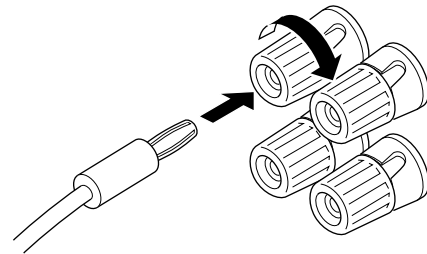

Notes

- One or two speaker systems can be connected to this unit. If you connect only one speaker system, connect it to either the **SPEAKERS A** or **B** terminals.
- Use speakers with the specified impedance shown on the rear of this unit.
- **<U.S.A., Canada, Australia and General models only>** Banana Plug connections are also possible. Simply insert the Banana Plug connector into the corresponding terminal.

ABOUT THE ACCESSORY TERMINALS

AC OUTLETS (SWITCHED)

(U.S.A., Canada, Singapore and General models)

..... 2 SWITCHED OUTLETS

(Australia model) 1 SWITCHED OUTLET

Use these to connect the power cords from your components to this unit.

The power to the **SWITCHED** outlets is controlled by this unit's **POWER** switch or the provided remote control transmitter's **POWER** key. These outlets will supply power to any component whenever this unit is turned on.

The maximum power (total power consumption of components) that can be connected to the **SWITCHED AC OUTLETS** is 100 watts.

GND terminal (For turntable use)

Connecting the ground wire of the turntable to the **GND** terminal will normally minimize hum, but in some cases better results may be obtained with the ground wire disconnected. Use one of the two **GND** terminals on the rear of this unit for the connection.

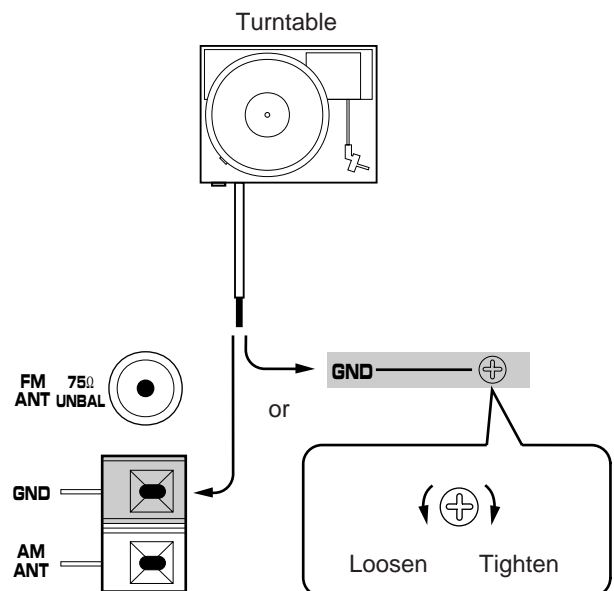

ANTENNA CONNECTIONS

- Each antenna should be connected to the designated terminals correctly, referring to the following diagram.
- Both AM and FM indoor antennas are included with this unit. In general, these antennas will probably provide sufficient signal strength. Nevertheless, a properly installed outdoor antenna will give clearer reception than an indoor one. If you experience poor reception quality, an outdoor antenna may result in improvement.

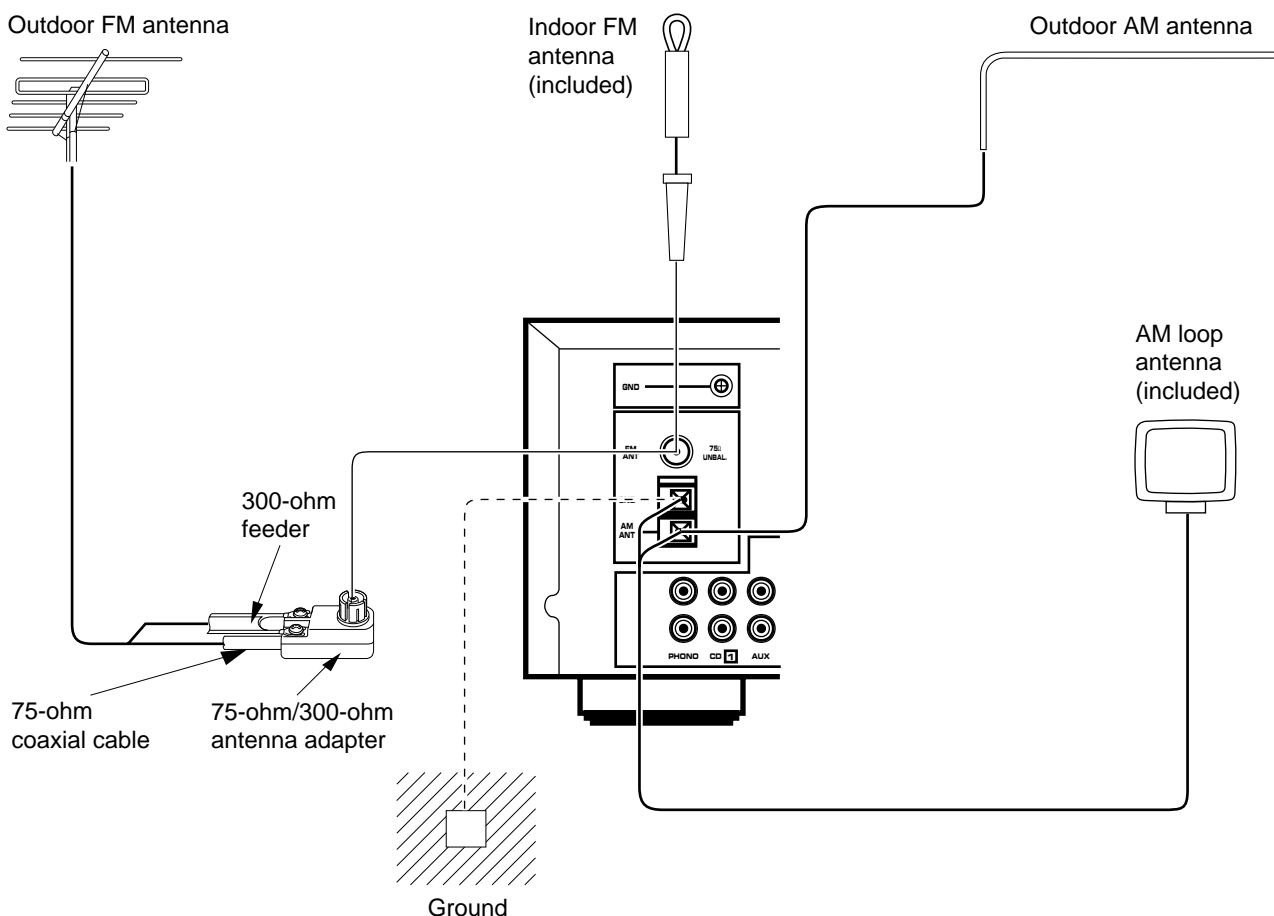

Connecting the AM loop antenna

1

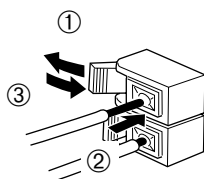

2

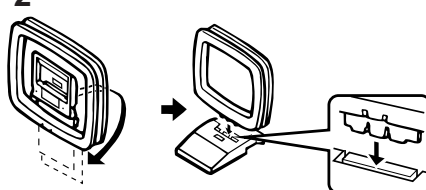

3



Orient so that the best reception is obtained.

* The AM loop antenna should be placed apart from the main unit. The antenna may be hung on a wall.

* The AM loop antenna should be kept connected, even if an outdoor AM antenna is connected to this unit.

GND terminal

For maximum safety and minimum interference, connect the **GND** terminal to a good earth ground. A good earth ground is a metal stake driven into moist earth.

Notes

- When connecting the indoor FM antenna, insert its connector into the **FM ANT** terminal firmly.
- If you need an outdoor FM antenna to improve FM reception quality, either 300-ohm feeder or coaxial cable may be used. In locations troubled by electrical interference, coaxial cable is preferable.

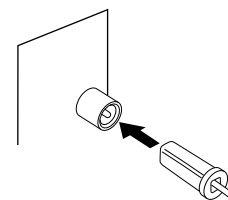

BASIC OPERATIONS

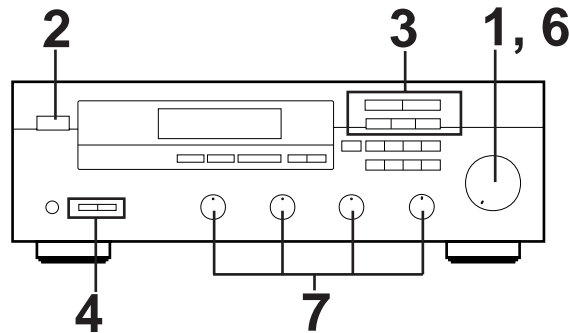

TO PLAY A SOURCE

1

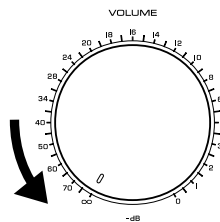

Set to the "∞" position.

2

Turn the power on.

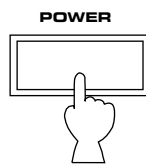

3

Select the desired input source by using the input selector buttons.

RX-495

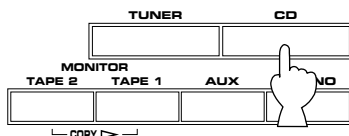

RX-395

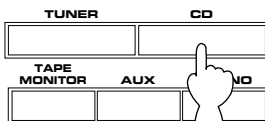

- * The name of the selected input source will appear on the display.
- * Note that pressing on each input selector button selects the source which is connected to the corresponding input terminals on the rear panel.

4

Select the speakers to be used.

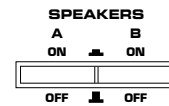

- * If you use two speaker systems, press both the A and B switches.

5

Play the source. (For detailed information on the tuning operation, refer to page 17.)

6

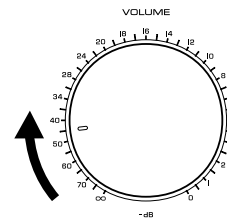

Adjust to the desired output level.

7

If desired, adjust the **BASS, TREBLE, BALANCE** and **LOUDNESS** controls, etc. (refer to page 16).

Notes

RX-495 only

- If you select **AUX, TUNER, CD** or **PHONO**, be sure that **TAPE 1** and/or **TAPE 2** are not being selected.
- If you select **TAPE 1** and **TAPE 2** at the same time, the result will be the sound from the tape deck 1.
- For **TAPE 1** and **TAPE 2**, whenever the button is pressed, the corresponding input source is selected or canceled alternately.

RX-395 only

- Whenever the **TAPE MONITOR** is pressed, the tape deck is selected or canceled alternately.
- If both **TAPE MONITOR** and another input selector button are selected, **TAPE MONITOR** takes priority of another input selector button.

To turn off the power

Press the **POWER** switch again.

TO RECORD A SOURCE TO TAPE

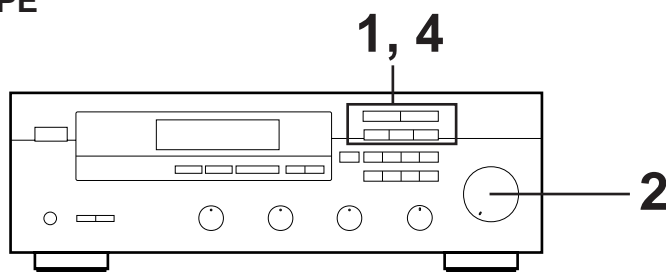

RX-495

- 1** Select the source to be recorded.

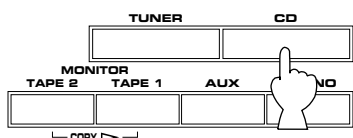

- * To dub from tape to tape, refer to the "Notes" shown below.
- * When you select **AUX**, **TUNER**, **CD** or **PHONO**, make sure that neither **TAPE 1** nor **TAPE 2** is also selected.

- 2** Play the source and then turn the **VOLUME** control up to confirm the input source. (For detailed information on the tuning operations, refer to the page 17.)

- 3** Begin recording on the tape deck.

- 4** To monitor the audio signals being recorded, press the input selector button for the tape deck being used to make the recording.

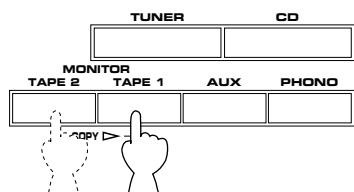

Notes

- **VOLUME, BASS, TREBLE, BALANCE, LOUDNESS** controls and **PURE DIRECT** switch settings have no effect on the material being recorded.
- To dub from tape to tape, select **TAPE 2** by pressing it. Only the following method of dubbing can be made by using this unit.

SOURCE	RECORDER
Tape deck connected to the TAPE 2 terminals.	→ Tape deck connected to the TAPE 1 terminals.

RX-395

- 1** Select the source to be recorded.

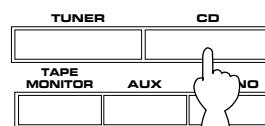

- * When you select **AUX**, **TUNER**, **CD** or **PHONO**, make sure that **TAPE MONITOR** is not also selected.

- 2** Play the source and then turn the **VOLUME** control up to confirm the input source. (For detailed information on the tuning operations, refer to the page 17.)

- 3** Begin recording on the tape deck.

- 4** To monitor the audio signals being recorded, press the **TAPE MONITOR**.

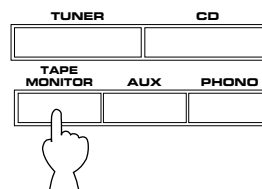

Note

VOLUME, BASS, TREBLE, BALANCE and **LOUDNESS** control settings have no effect on the material being recorded.

Selecting the SPEAKER system

Because one or two speaker systems can be connected to this unit, the **SPEAKERS** switches allow you to select speaker system **A** or **B**, or both at once.

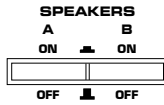

Adjusting the BALANCE control

Adjust the balance of the output volume to the left and right speakers to compensate for sound imbalance caused by speaker location or listening room conditions.



Adjusting the BASS and TREBLE controls

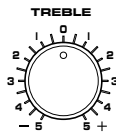
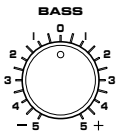

BASS : Turn this clockwise to increase (or counter-clockwise to decrease) the low frequency response.

TREBLE : Turn this clockwise to increase (or counter-clockwise to decrease) the high frequency response.

Using the PURE DIRECT switch

RX-495 only

You can enjoy the purest possible sound from your audio sources by pressing this switch inward. By doing so, the audio signal bypasses the **BASS**, **TREBLE**, **BALANCE** and **LOUDNESS** controls, eliminating any alterations to the audio signal.

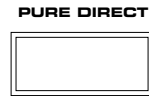

Adjusting the continuously variable LOUDNESS control

This control provides compensation for the human ears' loss of sensitivity to high and low-frequency ranges at low volume. This control is adjustable to retain full tonal range at any volume level.

1

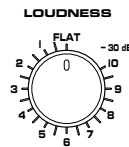

Set to the "FLAT" position.

2

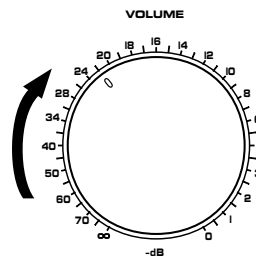

Set to the loudest listening level that you would listen to.

3

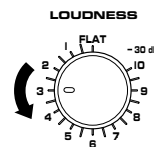

Turn until the desired volume is gained.

TUNING OPERATIONS

Normally, if station signals are strong and there is no interference, quick automatic-search tuning (AUTOMATIC TUNING) is possible. However, if signals of the station you want to select are weak, you must tune to it manually (MANUAL TUNING).

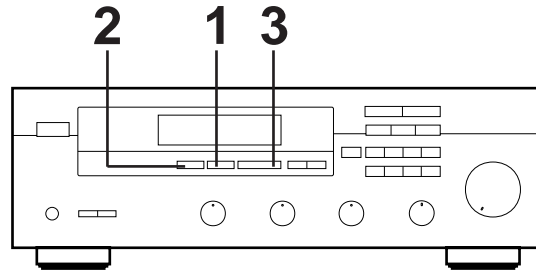

AUTOMATIC TUNING

- 1** Select the reception band (FM or AM) confirming it on the display.
- 2**
- 3**

To tune to a higher frequency, press the right side once.
 To tune to a lower frequency, press the left side once.

- * If the station where tuning search stops is not the desired one, press again.
- * If the tuning search does not stop at the desired station (because the signals of the station are weak), change to the MANUAL TUNING method.

MANUAL TUNING

- 1** Select the reception band (FM or AM) confirming it on the display.
- 2**
- 3** Tune to a desired station manually.

* To continue tuning search, press and hold the button.

Note

If you tune to an FM station manually, it is received in monaural mode automatically to increase the signal quality.

PRESET TUNING

MANUAL PRESET TUNING

This unit can store station frequencies (selected by tuning operation) by using the **PRESET STATIONS** buttons. With this function, you can recall any desired station by only pressing the corresponding **PRESET STATIONS** button. Up to 40 stations (8 stations x 5 groups) can be stored.

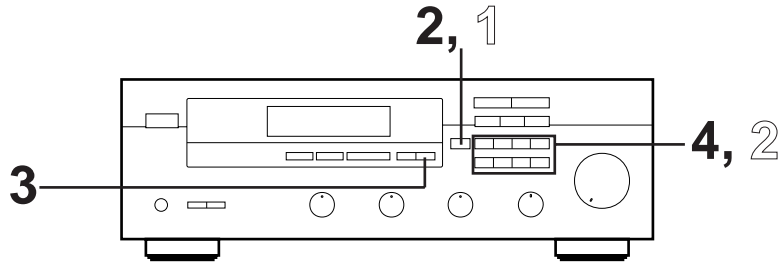

To store stations

1 Tune to a desired station.
(Refer to the previous page for tuning procedure.)

2 Select a desired group (A – E) of preset stations confirming it on the display.



3 Select a preset station number where you want to program the station before “MEMORY” goes off from the display.

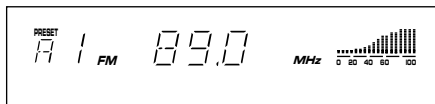
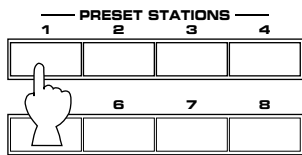
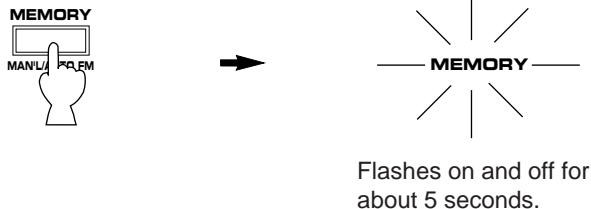

Shows the displayed station has been programmed to A1.

- * In the same way, program other stations to A2, A3 ... A8.
- * You can program more stations to preset station numbers on other groups in the same way by selecting other groups in step 2.

To recall a preset station

1 Select the group of preset stations.

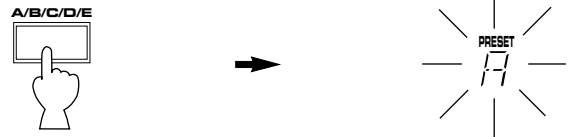

2 Select the preset station number.

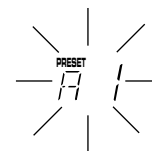
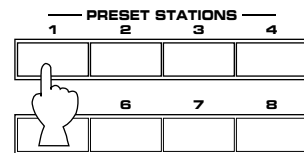

Notes

- A new setting can be programmed in place of the former one.
- For presets, the setting of the reception mode (stereo or monaural) is stored along with the station frequency.

Memory back-up

The memory back-up circuit prevents the programmed data from being lost even if the **POWER** switch is set off or the power plug is disconnected from the AC outlet or the power is cut due to temporary power failure. If, however, the power is cut for more than one week, the memory may be erased. If so, it can be re-programmed by simply following the PRESET TUNING steps.

AUTOMATIC PRESET TUNING

You can also make use of an automatic preset tuning function for FM stations only. By this function, this unit performs automatic tuning and stores FM stations with strong signals sequentially. Up to 40 stations are stored automatically in the same way as in the manual preset tuning method on page 18.

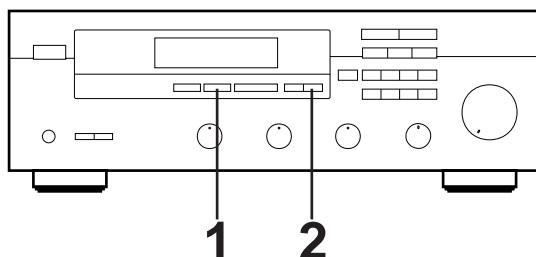

To store stations

1

FM

2

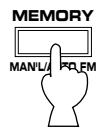

Press and hold for about 3 seconds.

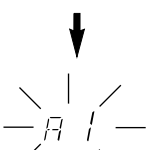

Flashes.



MEMORY



AUTO TUNING

After 5 seconds, the automatic preset tuning begins from A1. Received stations are programmed to A1, A2 ... A8 sequentially.
 * If more than 8 stations are received, they are also programmed to the preset station numbers on other groups (B, C, D and E) in that order.

When the automatic preset tuning is finished

The display shows the frequency of the last preset station. Check the contents and the number of preset stations by following the procedure of the section "To recall a preset station" on page 18.

To recall a preset station

Simply follow the procedure of the section "To recall a preset station" on page 18.

Notes

- If no station is received by the automatic preset tuning search, the search finishes after "NOTHING" flashes for about 3 seconds on the display.
- You can replace a preset station by another FM or AM station manually by simply following the procedure of the section "To store stations" on page 18.
- If the number of received stations is not enough to be stored up to E8, the search will be finished automatically when it reaches the highest frequency after searching through all frequencies.
- With this function, only FM stations with sufficient signal strength are stored automatically. If the station you want to program is weak in signal strength, tune to it in monaural manually and program it by following the procedure of the section "To store stations" on page 18.

If you want to store the first station received by the automatic preset tuning to a desired preset station number.

If, for example, you want to store the first received station to C5, select "C5" by using the **A/B/C/D/E** button and the **PRESET STATIONS** buttons after pressing the **MEMORY** button in step 2 before the automatic preset tuning begins. The first received station is stored to C5, and next stations to C6, C7 ... sequentially.

If stations are stored up to E8, the automatic preset tuning is finished automatically.

EXCHANGING PRESET STATIONS

You can exchange the places of two preset stations with each other as shown below.

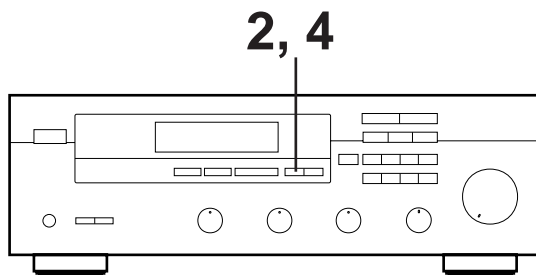

Example)

If you want to shift the preset station on E1 to A5, and vice versa.

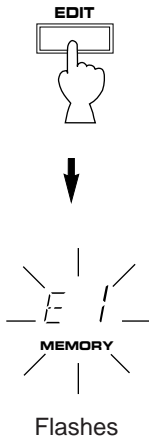
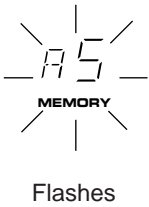
1 Recall the preset station on E1 (by following the method of "To recall a preset station" on page 18).
2 
3 Next, recall the preset station on A5 by following the same method with step 1. 

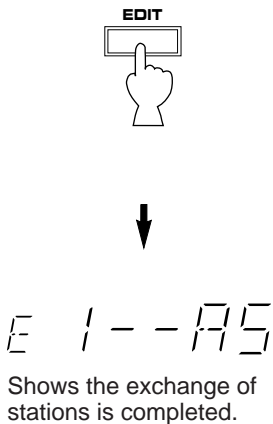
4 
--

NOTES ABOUT THE REMOTE CONTROL TRANSMITTER

Battery installation

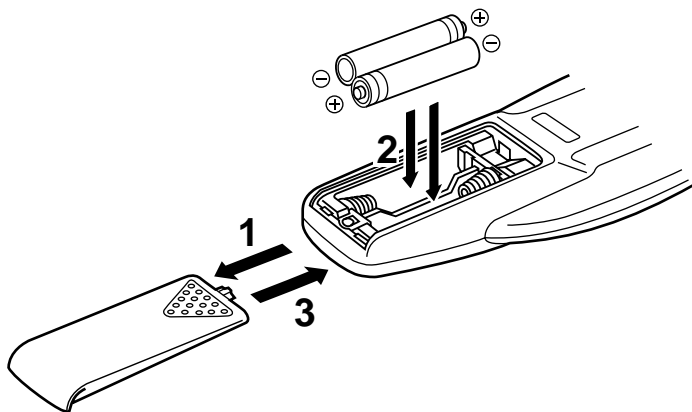

Battery replacement

If you find that the remote control transmitter must be used closer to the main unit, the batteries are weak. Replace both batteries with new ones.

Notes

- Use only AA, R6, UM-3 batteries for replacement.
- Be sure the polarities are correct. (See the illustration inside the battery compartment.)
- Remove the batteries if the remote control transmitter will not be used for an extended period of time.
- If batteries leak, dispose of them immediately. Avoid touching the leaked material or letting it come in contact with clothing, etc. Clean the battery compartment thoroughly before installing new batteries.

Remote control transmitter operation range

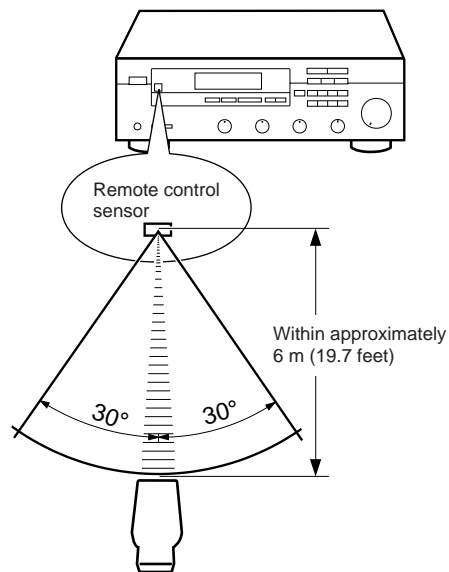

Notes

- There should be no large obstacles between the remote control transmitter and the main unit.
- If the remote control sensor is directly illuminated by strong lighting (especially an inverter type of fluorescent lamp etc.), it might cause the remote control transmitter not to work correctly. In this case, reposition the main unit to avoid direct lighting.

TROUBLESHOOTING

If the unit fails to operate normally, check the following points to determine whether the fault can be corrected by the simple measures suggested. If it cannot be corrected, or if the fault is not listed in the SYMPTOM column, disconnect the power cord and contact your authorized YAMAHA dealer or service center for help.

	SYMPTOM	CAUSE	REMEDY
Amplifier	The unit fails to turn on when the POWER switch is pressed.	Power cord is not plugged in or is not completely inserted.	Firmly plug in the power cord.
	No sound.	Incorrect output cord connections.	Connect the cords properly. If the problem persists, the cords may be defective.
		Appropriate input selector button is not pressed.	Press the appropriate input selector button corresponding to the input source.
		The SPEAKERS switches are not set properly.	Set the SPEAKERS switch that corresponds to the speakers to be used to the ON position.
		Speaker connections are not secure.	Secure the connections.
	The sound suddenly goes off.	The protection circuit has been activated because of short circuit etc.	Turning the unit off and then on will reset the protection circuit.
		The SLEEP timer functioned.	Cancel the SLEEP timer function.
	Only one side speaker outputs the sound.	Incorrect setting of the BALANCE control.	Adjust it to the appropriate position.
		Incorrect cord connections.	Connect the cords properly. If the problem persists, the cords may be defective.
	There is a lack of bass, and no ambience.	The + and – wires are connected in reverse at this unit or speakers.	Connect the speaker wires in the correct phase (+ and –).
Sound “hums”.	Incorrect cord connections.	Firmly connect the audio plugs. If the problem persists, the cords may be defective.	
	No connection from the turntable to the GND terminal.	Make the GND connection between the turntable and this unit.	
Sound level is low.	The LOUDNESS control is functioning.	Set the LOUDNESS control to the FLAT position.	
The volume level is low while playing a record.	The record is being played on a turntable with an MC cartridge.	The player should be connected to the unit through an MC head amplifier (available separately).	
The volume level cannot be increased, or sound is distorted.	The power to the component connected to the REC OUT terminals of this unit is off.	Turn the power to the component on.	
FM	FM stereo reception is noisy.	Because of the characteristics of FM stereo broadcasts, this is limited to cases where the transmitter is too far away or the antenna input is poor.	Check the antenna connections. Try using a high quality directional FM antenna. Set the TUNING MODE button to the manual tuning mode.
	There is distortion and clear reception cannot be obtained even with a good FM antenna.	There is multipath interference.	Adjust antenna placement to eliminate multipath interference.
	A desired station cannot be tuned in with the automatic tuning method.	The station is too weak.	Use the manual tuning method. Use a high quality directional FM antenna.
	Previously preset stations can no longer be tuned in.	The tuner has been unplugged for a long period.	Repeat the presetting procedure.
AM	A desired station cannot be tuned in with the automatic tuning method.	Weak signal or loose antenna connections.	Tighten the AM loop antenna connections and rotate it for best reception. Use the manual tuning method.
	There are continuous crackling and hissing noises.	Noises will result from lightning, fluorescent lamps, motors, thermostats and other electrical equipment.	Use an outdoor antenna and a ground wire. This will help somewhat but it is difficult to eliminate all noise.
	There are buzzing and whining noises (especially in the evening).	A television set is being used nearby.	Relocate this unit away from the TV.
Remote control Transmitter	The remote control transmitter does not work.	Direct sunlight or lighting (of an inverter type of fluorescent lamp etc.) is striking the remote control sensor of the main unit.	Change the position of the main unit.
		The batteries of this remote control transmitter are too weak.	Replace the batteries with new ones.
Others	The sound is degraded when listening with the headphones connected to the compact disc player or cassette deck that are connected with this unit.	The power to this unit is off.	Turn the power to this unit on.

SPECIFICATIONS

AUDIO SECTION

Minimum RMS Output Power per Channel

8 ohms, 20 Hz to 20 kHz, 0.04% THD	
<RX-495>	70W+70W
<RX-395>	45W+45W
6 ohms, 20 Hz to 20 kHz, 0.06% THD	
<RX-495>	80W+80W
<RX-395>	48W+48W

Dynamic Power per Channel

(by IHF Dynamic Headroom measuring method)

<RX-495>	
8/6/4/2 ohms	100/120/145/170W
<RX-395>	
8/6/4/2 ohms	68/75/85/95W

DIN Standard Output Power per Channel

4 ohms, 1 kHz, 0.7% THD	
[Singapore model only]	
<RX-495>	100W
<RX-395>	55W

IEC Power

8 ohms, 1 kHz, 0.04% THD	
[Singapore model only]	
<RX-495>	80W
<RX-395>	50W

Power Band Width

<RX-495>	
8 ohms, 35W, 0.08% THD	10 Hz to 50 kHz
<RX-395>	
8 ohms, 22.5W, 0.08% THD	10 Hz to 50 kHz

Damping Factor

8 ohms, 20 Hz to 20 kHz	100 or more
-------------------------------	-------------

Maximum Output Power (EIAJ)

[General model only]	
<RX-495>	
8 ohms, 1 kHz, 10% THD	100W
<RX-395>	
8 ohms, 1 kHz, 10% THD	70W

Input Sensitivity/Impedance

PHONO MM	2.5 mV/47 k-ohms
CD/TAPE/AUX	150 mV/47 k-ohms

Maximum Input Signal (1 kHz, 0.04% THD)

PHONO MM	90 mV
----------------	-------

Output Level

REC OUT	150 mV
---------------	--------

Headphone Jack Rated Output/Impedance

Output Level (8 ohms, 0.04% THD)	
<RX-495>	0.48V
<RX-395>	0.45V
Impedance	
<RX-495>	390 ohms
<RX-395>	330 ohms

Frequency Response (20 Hz to 20 kHz)

CD/TAPE/AUX	0±0.5 dB
-------------------	----------

RIAA Equalization Deviation

PHONO MM	0±0.5 dB
----------------	----------

Total Harmonic Distortion

PHONO MM to REC OUT	
20 Hz to 20 kHz, 1V	0.02%
CD/TAPE/AUX to SP OUT	
20 Hz to 20 kHz, 35W/8 ohms	0.02%

Signal-to-Noise Ratio (IHF-A Network)

PHONO MM to REC OUT	
(5 mV Input Shorted)	82 dB
CD/TAPE/AUX to SP OUT (Input Shorted)	108 dB

Residual Noise (IHF-A Network)..... 100 µV

Channel Separation (Vol. -30 dB, EFFECT OFF)

CD/TAPE/AUX	
(Input 5.1 k-ohms Terminated, 1 kHz)	60 dB

Tone Control Characteristics

BASS: Boost/cut	±10 dB (50 Hz)
Turnover Frequency	(350 Hz)
TREBLE: Boost/cut	±10 dB (20 kHz)
Turnover Frequency	(3.5 kHz)

Continuous Loudness Control.....- 30 dB (1 kHz) (Level related equalization)

FM SECTION

Tuning Range

[Australia, Singapore and General models]	
.....	87.5 to 108.0 MHz
[U.S.A. and Canada models]	87.5 to 107.9 MHz

50 dB Quieting Sensitivity (IHF, 75 ohms)

[Except Singapore model]	
Mono	1.55 µV (15.1 dBf)
Stereo	21 µV (37.7 dBf)

Usable Sensitivity (75 ohms)
 (30 dB S/N Quieting, 1 kHz, 100% mod.)
 [Except Singapore model].....0.8 μ V (9.3 dBf)
 DIN, Mono (S/N 26 dB) [Singapore model only]
0.9 μ V
 DIN, Stereo (S/N 46 dB) [Singapore model only]
24 μ V

Image Response Ratio
 [Singapore model only].....80 dB
 [Except Singapore model].....45 dB

IF Response Ratio80 dB

Spurious Response Ratio70 dB

AM Suppression Ratio55 dB

Capture Ratio.....1.5 dB

Alternate Channel Selectivity
 [Except Singapore model].....85 dB

Selectivity (two signals , \pm 300 kHz, 40 kHz Dev.)
 [Singapore model only].....70 dB

Signal-to-Noise Ratio
 (IHF) Mono/Stereo
 [Except Singapore model]80 dB/75 dB
 (DIN-Weighted, 40 kHz Dev.) Mono/Stereo
 [Singapore model only].....75 dB/70 dB

Harmonic Distortion
 Mono/Stereo (1kHz, 40 kHz Dev.)
0.1%/0.2%

Stereo Separation
 (1 kHz, 40 kHz Dev.).....50 dB

Frequency Response
 20 Hz to 15 kHz0 \pm 1.5 dB

AM SECTION

Tuning Range
 [Australia and Singapore models]531 to 1,611 kHz
 [U.S.A., Canada and General models]
530 to 1,710 kHz

Usable Sensitivity100 μ V/m

Selectivity.....32 dB

Signal-to-Noise Ratio50 dB

Image Response Ratio40 dB

Spurious Response Ratio50 dB

Harmonic Distortion (1 kHz)0.3%

AUDIO SECTION

Output Level/Impedance
 FM (100% mod., 1 kHz)500 mV/2.2 k-ohms
 AM (30% mod., 1 kHz)150 mV/2.2 k-ohms

GENERAL

Power Supply
 [U.S.A. and Canada models].....AC 120V, 60 Hz
 [Australia model].....AC 240V, 50 Hz
 [Singapore model]AC 230V, 50 Hz
 [General model]AC 110-120/220-240V, 60/50 Hz

Power Consumption
 <RX-495>
 [U.S.A. model].....160W
 [Canada model].....260VA, 210W
 [Australia, Singapore and General models]145W
 <RX-395>
 [U.S.A., Singapore, Australia and General models]
120W
 [Canada model]170W

AC Outlets
 2 SWITCHED OUTLETS
 [U.S.A., Canada, Singapore and General models]
100W max. total
 1 SWITCHED OUTLET
 [Australia model]100W max. total

Dimensions (W x H x D)435 x 146 x 308.5 mm
 (17-1/8" x 5-3/4" x 12-1/8")

Weight
 <RX-495>7.8 kg (17 lbs. 3 oz.)
 <RX-395>6.5 kg (14 lbs. 5 oz.)

Accessories.....AM loop antenna
 Indoor FM antenna
 Remote control transmitter
 Batteries
 <U.S.A. and Canada model only>
 Antenna adapter

Specifications are subject to change without notice.

YAMAHA

YAMAHA ELECTRONICS CORPORATION, USA 6660 ORANGETHORPE AVE., BUENA PARK, CALIF. 90620, U.S.A.
YAMAHA CANADA MUSIC LTD. 135 MILNER AVE., SCARBOROUGH, ONTARIO M1S 3R1, CANADA
YAMAHA ELECTRONIK EUROPA G.m.b.H. SIEMENSSTR. 22-34, D-25462 RELLINGEN BEI HAMBURG, F.R. OF GERMANY
YAMAHA ELECTRONIQUE FRANCE S.A. RUE AMBROISE CROIZAT BP70 CROISSY-BEAUBOURG 77312 MARNE-LA-VALLÉE CEDEX02, FRANCE
YAMAHA ELECTRONICS (UK) LTD. YAMAHA HOUSE, 200 RICKMANSWORTH ROAD WATFORD, HERTS WD1 7JS, ENGLAND
YAMAHA SCANDINAVIA A.B. J A WETTERGRENS GATA 1, BOX 30053, 400 43 VÄSTRA FRÖLUNDA, SWEDEN
YAMAHA MUSIC AUSTRALIA PTY, LTD. 17-33 MARKET ST., SOUTH MELBOURNE, 3205 VIC., AUSTRALIA

YAMAHA CORPORATION

VU26730