

To assure the finest performance, please read this manual carefully.  
Keep it in a safe place for future reference.

**Package contents**

Check that the following accessories are supplied with the product.

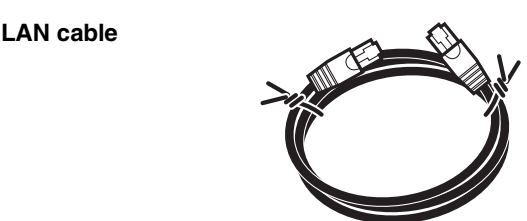

Owner's Manual (this manual)

**Features**

Allows Yamaha AV products equipped with a NETWORK port and a DC OUT jack to be connected with a wireless LAN.  
Compatible devices can connect to the YWA-10 through a USB connector instead of a DC OUT jack.  
Refer to the website below for a list of compatible devices.  
<http://yamaha.com/>

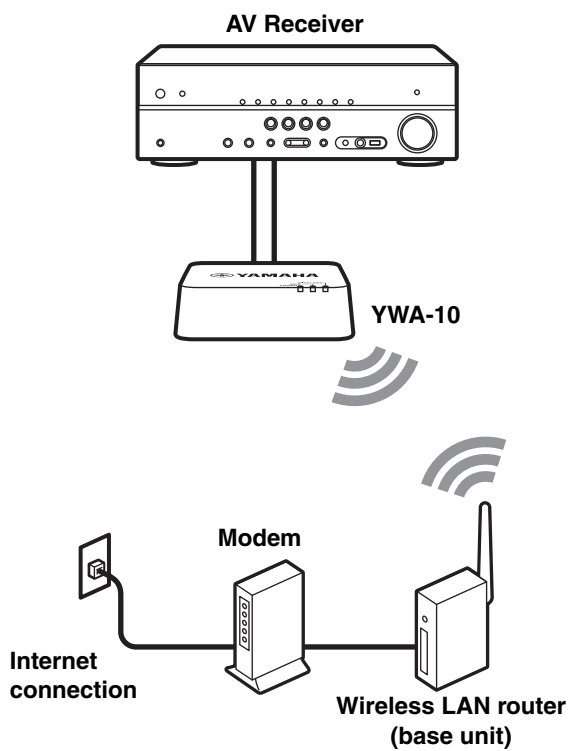

The firmware of this unit may be updated at times for improvement. Please refer to the following website for information on firmware updates.  
<http://yamaha.com/>

**Setup procedure**

**Checking the base unit**

- Check that the Wireless LAN router (base unit) can connect to the Internet.

**Connecting to the base unit**

- When the Wireless LAN router (base unit) has a WPS button  
→ Carry out the procedures in "Step 2-A Connecting to the base unit (using WPS)" to connect to the base unit.
- When the Wireless LAN router (base unit) does not have a WPS button  
→ Carry out the procedures in "Step 2-B Connecting to the base unit (manual configuration)" to connect to the base unit.  
\* If connecting using "(using WPS)" does not succeed, refer to "(manual configuration)" and configure the connection.

**Connecting to an AV product**

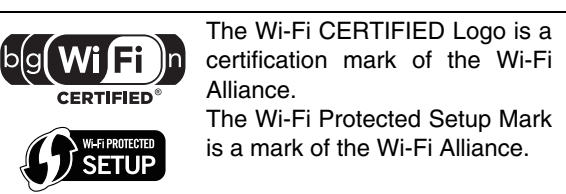

**Step 2-A Connecting to the base unit (using WPS)**

**Notes**

- This explanation details the procedure for connecting using the WPS function. When using a base unit that is not equipped with a WPS function, refer to "Step 2-B Connecting to the base unit (manual configuration)" at right.
- You will need to change the IP address of this unit if you are using more than one YWA-10 at the same time.  
Refer to "Troubleshooting" on the reverse page for more details.

**1. Supply power to the YWA-10**

1 Turn on the power of the AV product that you wish to connect this unit to.

2 Use the supplied USB power cable to connect the power connector on this unit to the DC OUT jack on the AV product.

The indicator on the front panel of this unit lights. Wait for approximately one minute after the indicator lights and then carry out the following procedure.

**Note**

If the AV product is not equipped with a DC OUT jack, connect to the USB connector on the front panel.

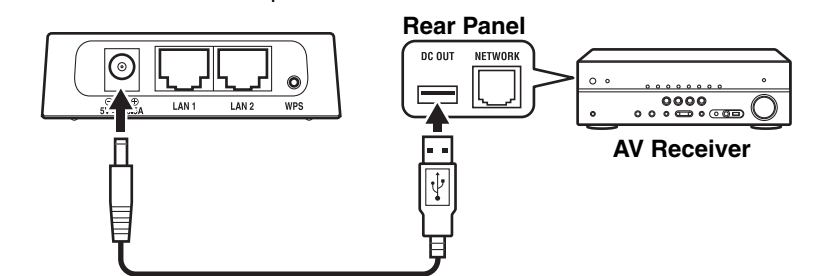

**2. Connect the base unit**

1 Press the WPS button on the wireless LAN router (base unit).  
Refer to the owner's manual of the wireless LAN router (base unit) for information on how to use the WPS button.

2 Press and hold the WPS button on the rear of this unit for more than 5 seconds and release it.  
The WPS indicator on the front panel lights.

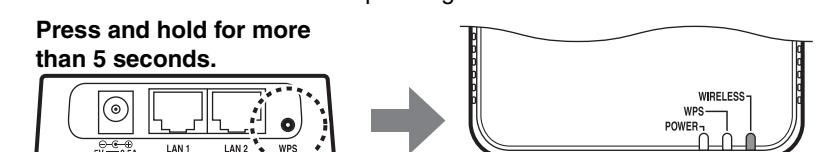

3 Wait until the WPS indicator turns off (this will take two minutes at most).

**Note**

If the WPS indicator blinks, carry out procedure 2 again, starting at number 1.

This completes connection with the base unit. Proceed to "Step 3 Connecting to an AV product".

**Step 2-B Connecting to the base unit (manual configuration)**

**Notes**

- When making a manual connection to the base unit, or when you are unable to connect using the procedure described in "Step 2-A Connecting to the base unit (using WPS)" at left, refer to the explanation below.
- If the PC you are using to configure this unit is connected to the wireless LAN, turn the PC's wireless LAN function off.
- You will need to change the IP address of this unit if you are using more than one YWA-10 at the same time.  
Refer to "Troubleshooting" on the reverse page for more details.

**1. Check the network that you are attempting to connect to.**

You will need the setting information from the wireless LAN router (base unit) when connecting or setting up this unit. Have the following table ready for use.  
\* Refer to the owner's manual of the wireless LAN router (base unit) for information on how to check its wireless LAN settings.

**■ When using WEP security settings**

	Name	Wireless LAN setting
(1)	SSID	
(2)	Security mode	<input type="checkbox"/> Open <input type="checkbox"/> Shared
(3)	Security key type	<input type="checkbox"/> Hexadecimal*1 <input type="checkbox"/> ASCII*2
(4)	Default key	<input type="checkbox"/> Key 1 <input type="checkbox"/> Key 2 <input type="checkbox"/> Key 3 <input type="checkbox"/> Key 4
(5)	Password	

\*1: 16-digit number (0-9, A-F), \*2: ASCII (0-9, A-Z, a-z)

**■ When using WPA/WPA2 security settings**

	Name	Wireless LAN setting
(1)	SSID	
(2)	Security mode	<input type="checkbox"/> WPA-PSK <input type="checkbox"/> WPA2-PSK
(3)	Encryption type	<input type="checkbox"/> TKIP <input type="checkbox"/> AES
(4)	Password	

**Note**

Use only alpha-numeric characters (0-9, A-Z, a-z) for an SSID or password. Otherwise, Yamaha cannot guarantee normal operation.  
Refer to the owner's manual of the wireless LAN router (base unit) for information on how to change the SSID or password.

**2. Connect this unit to a PC**

1 Turn the PC power on.

2 Use the supplied LAN cable to connect the LAN1 port (or the LAN2 port) on this unit to the LAN port on the PC. Then, use the supplied USB power cable to connect the power connector on this unit to the USB connector on the PC.

The indicator on the front panel of this unit lights. Wait for approximately one minute after the indicator lights and then carry out the following procedure.

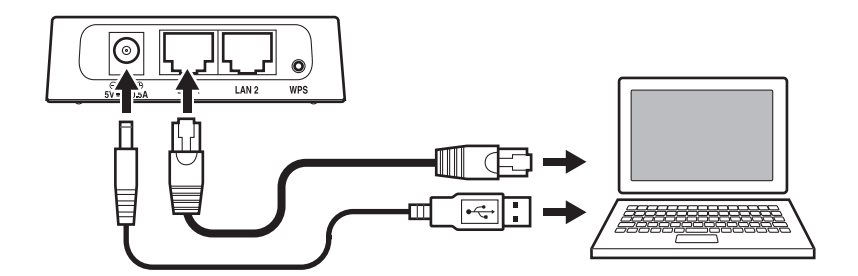

**3. Setting up this unit**

1 Start the web browser on the PC.

2 Enter "ywa.setup" in the address field in the Web browser, and press the Enter key.

**Note**

If the login screen does not appear even after you enter "ywa.setup", enter "192.168.1.249" and press the Enter key. If the login screen still does not appear, refer to "Troubleshooting".

**Part names**

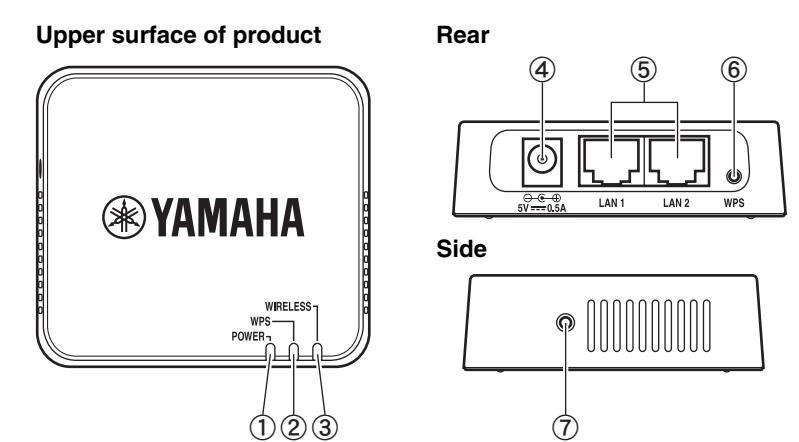

- ① POWER indicator
- ② WPS indicator
- ③ WIRELESS indicator
- ④ Power connector
- ⑤ LAN1 port, LAN2 port
- ⑥ WPS button
- ⑦ Reset button

**Things to check before setup**

- If you do not already have an Internet connection, please apply for one before setting up this unit.
- Do not connect the USB power cable to a USB hub.

**Step 1 Checking the base unit**

1 Check that the wireless LAN router (base unit) can connect to the Internet without difficulty.

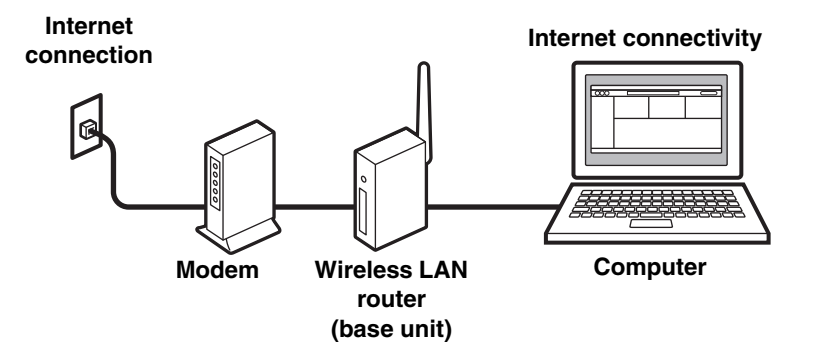

**Notes**

- If you do not currently have an Internet subscription, please obtain one.
- A wireless LAN router is required to set up a connection using this procedure. Please obtain a wireless LAN router if you do not have one available.

2 Check whether the wireless LAN router (base unit) is WPS compatible. Check the owner's manual and other documentation supplied with the wireless LAN router.

**Note**

WPS (Wi-Fi Protected Setup) is a function that uses a button to configure connections and security on wireless LAN devices.  
\*Some Wi-Fi devices have "WPS" written on them.

- ▶ **When the wireless LAN router (base unit) has a WPS button**  
Carry out "Step 2-A Connecting to the base unit (using WPS)", and then "Step 3 Connecting to an AV product", in that order.
- ▶ **When the wireless LAN router (base unit) does not have a WPS button**  
Carry out "Step 2-B Connecting to the base unit (manual configuration)", and then "Step 3 Connecting to an AV product", in that order.

- On the login screen, enter “admin” in the user name field, and “password” in the password field, and then click the OK button.



**Note**

If you cannot login to the setup screen, check that you have entered the correct letters.

- Where necessary, select the display language from the drop-down list. The screen display language changes.

**Note**

The display examples in this manual use English as the display language.

- Click [Setup Wizard] and then [Next], in that order. The “Wireless Site Survey” screen appears.

- On the “Wireless Site Survey” screen, choose the same SSID as in (1) on the table in “1 Check the network that you are attempting to connect to.” and then click [Next].



**Notes**

- When the SSID does not appear, click [Refresh] and then search again.
- If the SSID (the name of the device you are connecting to) does not display even when the above operation is performed, the wireless LAN router (base unit) power is turned off, or the SSID name notification is turned off (SSID Broadcast refusal). In such cases, enter the same SSID as the wireless LAN router (base unit) directly.
- It is recommended that you connect to an SSID with an RSSI (Received Signal Strength Indication) of 50 or above.

- Follow the procedure in “1 Check the network that you are attempting to connect to.” to set up this unit.

When (2) in the table is “Open / Shared”

Refer to “■ When using WEP security settings” in the table on the reverse page to set up this unit.

- Enter the profile name of your choice in “profile name”.
- When (2) in the table is “Open”
  - Select “Open” under “Encryption”.
  - When (2) in the table is “Shared”
    - Select “SHARED” under “Encryption”.
- When (5) in the table is set to use a 10 or 5 letter password
  - Select “64Bit” under “Key Length”.
  - When (5) in the table is set to use a 26 or 13 letter password
    - Select “128Bit” under “Key Length”.
- When (3) in the table is “Hexadecimal”
  - Select “Hex” under “Key Format”.
  - When (3) in the table is “ASCII”
    - Select “ASCII” under “Key Format”.

- Enter the same encryption key as in (5) on the table in the same Encryption key field as in (4) in the table. For example, when (4) in the table is “Key 1”, enter the same password as “Encryption Key 1” from (5) in the table.

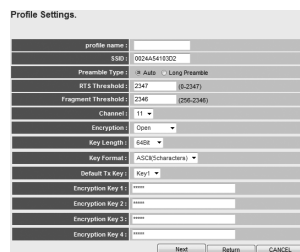

- Select the same default key as (4) from the table in “Default Tx Key”.

- Click [APPLY].

When (2) in the table is “WPA-PSK”/“WPA2-PSK”

Refer to “■ When using WPA/WPA2 security settings” in the table on the reverse page to set up this unit.

- Enter the profile name of your choice in “profile name”.
- Enter the same password as in (4) from the table in the “Pre-shared Key” field.
- Click [APPLY].

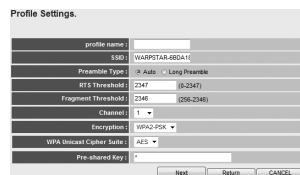

**Note**

To register multiple base units repeat procedures 5 through 7.

- The “LAN Setup” screen appears. Change the IP address if it is already being used by another device. Check the settings and click [APPLY].

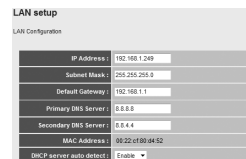

- The seconds before this unit restarts are counted down (30 seconds). When the count reaches “0”, this unit will restart. Click “OK” and check that this unit can connect to the access point.

- Close the browser.

- Remove the connected LAN cable and USB power cable.

This completes connection with the base unit. Proceed to “Step 3 Connecting to an AV product”.

### Step 3 Connecting to an AV product

- Use the supplied LAN cable to connect the LAN1 port (or the LAN2 port) on this unit to the NETWORK port on the AV product. Then, use the supplied USB power cable to connect the power connector on this unit to the DC OUT jack on the AV product.

The indicator on the front panel of this unit lights. Wait for approximately one minute and then carry out the following procedure.

**Note**

If the AV product is not equipped with a DC OUT jack, connect to the USB connector on the front panel.

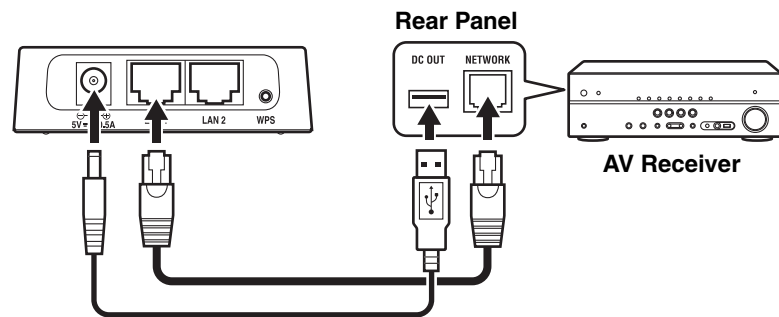

- Turn on the power of the AV product that you wish to connect this unit to.

- Check that the network functions of the connected AV products function correctly. Refer to the owner’s manual of the AV product for information on these network functions.

This completes the setup procedure.

### Troubleshooting

**■ The power does not turn on**

- Check that the USB power cable is firmly connected to this unit and the AV product.
- Check that the AV Receiver Network Standby is set to ON. (If Network Standby is OFF, power supply to the DC OUT jack will turn OFF when the AV Receiver is set to Standby.)

**■ Cannot connect using WPS**

- Only some devices are WPS compatible. If you are unable to connect using WPS, configure the settings manually.

**■ An error occurs when “ywa.setup” or “192.168.1.249” is input in the address field of the web browser, or the login screen does not appear.**

- Check the IP address settings (automatic or fixed setting) of the PC. If the PC is set to fixed setting, change it to automatic.
- The IP address of this unit may have changed from its default setting. Refer to “Resetting this unit” and reset this unit.
- If you are using any security software, turn it off temporarily. Refer to the owner’s manual of the security software for information on how to turn it off.
- If the wireless channel of the base unit is set to “12” or “13”, change it to a channel between “1” and “11”. (USA and Canada models only)

**■ Cannot log in from the login screen**

- The ID and password may have been changed. Refer to “Resetting this unit” and reset this unit.

**■ Unable to find the base unit in “Wireless Site Survey” on the setup screen**

- If this unit is too far away from the base unit (wireless LAN router, etc.) or there is an obstacle between them, try searching again in close proximity to the base unit, in a location where there are no obstacles between the two devices.
- The base unit may be set to refuse SSID Broadcast. Set the SSID, security mode, and key by hand.

**■ Unable to configure settings in “Wireless Site Survey” on the setup screen**

- Check the SSID. If the base unit SSID or password contain characters that this unit cannot use, the password is greater than 30 characters long, or the SSID is greater than 32 characters long, change them to settings that are compatible with this unit.
- Check the base unit security mode, and set the same security mode on the YWA-10 setup screen.
- The password you have entered may be incorrect. Check the password and re-enter it.
- If multiple base units are registered, select the units to which you wish to connect, and click [Connect].

**■ Not connected to the Internet, or connected to the Internet, but experiencing sound skipping.**

- There may be a problem with your Internet environment. Without using this unit, check whether your PC can connect to the Internet, as in Step 1.
- Refer to “Step 3 Connecting to an AV product” and check that the products and cables are connected correctly.
- If this unit is too far away from the base unit (wireless LAN router, etc.) or there is an obstacle between them, try searching again in close proximity to the base unit, in a location where there are no obstacles between the two devices.
- If there is a microwave oven in the immediate area, electromagnetic waves from the microwave oven may be interfering with the wireless transmissions. Move further away from the microwave oven and try connecting again.
- The base unit may be restricting connections by MAC Address. Add the MAC address written on the underside of this unit to the list of permitted connections on the base unit.
- Turn on the power to this unit again.
- Turn on the power to the base unit (wireless LAN router, etc) again.
- Check the IP address settings (automatic or fixed setting) of the network device to which this product is to be connected. If the network device is set to fixed setting, change it to automatic.
- Check that the DHCP server function on the base unit is set to ON.
- Try removing and reinserting the LAN cable connecting this unit and the AV Receiver.
- Connection is not possible if multiple YWA-10 units are in use, or if another device is using the IP address “192.168.xxx.249”. Refer to “Changing the IP address” and change to a unique IP address.
- If you are unable to connect even after performing the above procedure, reset this unit. Refer to “Resetting this unit” for information on resetting.
- Audio content that utilizes a significant amount of data may not transmit correctly over a wireless connection in some cases. Use audio formats that require a small amount of data.

### Resetting this unit

**Note**  
Resetting this unit will erase all of its settings. Be sure to note down the necessary information before resetting.

- Check that this unit’s power is on.
  - Press the Reset button for at least 10 seconds.
  - Release the Reset button when all the indicators are blinking.
- When this unit restarts after approximately 2 minutes, resetting is complete. When resetting is complete, set up this unit again, starting from “Step 2-A Connecting to the base unit (using WPS)” or “Step 2-B Connecting to the base unit (manual configuration)”.

### Changing the IP address

- Reset this unit. Refer to “Resetting this unit”.
- Connect this unit to a PC. Refer to “2 Connect this unit to a PC” in “Step 2-B Connecting to the base unit (manual configuration)”.
- Open the setting screen of this unit. Refer to “3 Setting up this unit” in “Step 2-B Connecting to the base unit (manual configuration)”, and carry out procedures 1-3.
- Click “Network” in the menu in the upper area of the setting screen.
- On the “LAN Setup” screen, enter “192.168.1.xxx” as an IP address. Set the “xxx” in “192.168.1.xxx” to a number that is between 2 and 248, and one that is not used by other devices.
- Click [APPLY].
- Set up this unit again. Carry out “Step 2-A Connecting to the base unit (using WPS),” or “Step 2-B Connecting to the base unit (manual configuration)”.

### Factory default settings

User name (Login ID): admin  
IP address: 192.168.1.249  
Password: password

### Specifications

**Wireless section**

Wireless type .....	IEEE802.11n, IEEE802.11g, IEEE802.11b
Frequency of operation .....	US: 1—11 ch, EU: 1—13 ch
Frequency band .....	2.4 GHz (2,400—2,483.5 MHz)
Type of modulation .....	IEEE802.11n: OFDM, IEEE802.11g: OFDM, IEEE802.11b: DSSS
Antenna gain .....	2 dBi
Antenna .....	Internal antenna x 2 (2T2R)
Access mode .....	Infrastructure mode
Bandwidth .....	20 MHz and 40 MHz
Security .....	WPA2-PSK (TKIP), WPA2-PSK (AES), WPA-PSK (TKIP), WPA-PSK (AES), SHARED, OPEN (WEP: 64bit/128bit, Key format: ASCII/Hexadecimal), Disabled (No encryption)

**Wired section**

Ethernet type .....	IEEE802.3u (100Base-Tx), IEEE802.3i (10Base-T)
Interface .....	RJ-45 port x 2 (LAN x 2)
Ethernet cable .....	Category 5 or more
<b>Configuration window requirement</b>	
OS .....	Windows 7(32bit/64bit)/Vista(32bit/64bit)/XP, Mac OS X 10.4/10.5/10.6, CPU: Intel/PowerPC support)

**Browser** .....

Internet Explorer 6 or above, Firefox 5.0 or above	
<b>General</b>	
Dissipation power .....	Maximum of approximately 2.3 W
Power supply .....	DC +5V 0.5 A
External dimensions .....	78 x 70 x 22 (mm) *Excluding protrusions
Weight .....	62 g
Operating temperature range .....	Temperature: 0—40 °C
	Humidity: 10—90 % (No condensation)
Strage temperature range .....	Temperature: -20—60 °C
	Humidity: 10—90 % (No condensation)

\* Specifications are subject to change without notice.

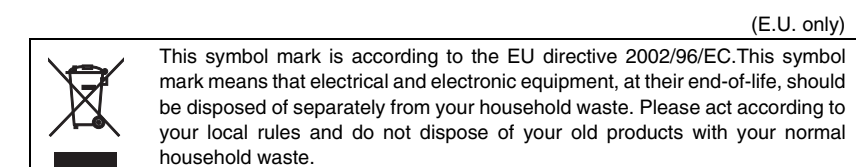

**■ Precautions**  
**Read this before using this unit.**  
To assure the finest performance, please read this manual carefully. Keep it in a safe place for future reference.

- Install this unit in a cool, dry, clean place away from direct sunlight, heat sources, and sources of excessive vibration, dust, moisture, and/or cold. (Do not use/keep this unit in a car etc.)
- Locate this unit away from other electrical appliances, motors, or transformers to avoid humming sounds.
- Do not expose this unit to sudden temperature changes from cold to hot, and do not locate this unit in an environment with high humidity (i.e. a room with a humidifier) to prevent condensation inside this unit, which may cause an electrical shock, fire, damage to this unit, and/or personal injury.
- Do not clean this unit with chemical solvents; this might damage the finish. Use a clean, dry cloth.
- Do not attempt to modify or fix this unit. Contact qualified Yamaha service personnel when any service is needed. The cabinet should never be opened for any reason.
- Be sure to read the “Troubleshooting” section regarding common operating errors before concluding that the unit is faulty.
- Before moving this unit, disconnect USB power cable from the AV product.

Do not use this unit within 22 cm (9 inches) of persons with a heart pacemaker implant or defibrillator implant.

**Explanations regarding GPL**  
This product utilizes GPL/LGPL open-source software in some sections. You have the right to obtain, duplicate, modify, and redistribute this open-source code only. For information on GPL/LGPL open source software, how to obtain it, and the GPL/LGPL license, refer to the Yamaha Corporation website (<http://download.yamaha.com/sourcecodes/ywa-10/>).

- This product is limited to indoor use only.
- Frequencies used by this product may be prohibited to use in some countries. As a user of this product, you have responsibilities to use this product only in the intended countries and confirm that this product is set to use frequencies and channels that are allowed to use in your country. Violators may be punishable by law of the country. For information about laws of each country, please refer to “ERC/REC 70-03”.

We, the manufacturer (Yamaha Corporation) hereby declare that this equipment (Wireless Network Adapter), model YWA-10 is in compliance with the essential requirements and other relevant provisions of Directive 1999/5/EC.

- Microsoft, Windows 7, Windows Vista and Windows XP are registered trademarks or trademarks of Microsoft Corporation in the U.S. and other countries.
- Other product names, technology names, and company names mentioned in this manual may be trademarks or registered trademarks of their respective owners and are hereby acknowledged.