

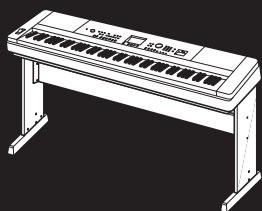

Portable Grand

DGX-650

Owner's Manual



Keyboard Stand Assembly

For information on assembling the keyboard stand, refer to the instructions on **page 10** of this manual.



Setting Up

Basic Guide

Reference

Appendix

EN

SPECIAL MESSAGE SECTION

This product utilizes batteries or an external power supply (adapter). DO NOT connect this product to any power supply or adapter other than one described in the manual, on the name plate, or specifically recommended by Yamaha.

WARNING: Do not place this product in a position where anyone could walk on, trip over, or roll anything over power or connecting cords of any kind. The use of an extension cord is not recommended! If you must use an extension cord, the minimum wire size for a 25' cord (or less) is 18 AWG. NOTE: The smaller the AWG number, the larger the current handling capacity. For longer extension cords, consult a local electrician.

This product should be used only with the components supplied or; a cart, rack, or stand that is recommended by Yamaha. If a cart, etc., is used, please observe all safety markings and instructions that accompany the accessory product.

SPECIFICATIONS SUBJECT TO CHANGE:

The information contained in this manual is believed to be correct at the time of printing. However, Yamaha reserves the right to change or modify any of the specifications without notice or obligation to update existing units.

This product, either alone or in combination with an amplifier and headphones or speaker/s, may be capable of producing sound levels that could cause permanent hearing loss. DO NOT operate for long periods of time at a high volume level or at a level that is uncomfortable. If you experience any hearing loss or ringing in the ears, you should consult an audiologist.

IMPORTANT: The louder the sound, the shorter the time period before damage occurs.

Some Yamaha products may have benches and / or accessory mounting fixtures that are either supplied with the product or as optional accessories. Some of these items are designed to be dealer assembled or installed. Please make sure that benches are stable and any optional fixtures (where applicable) are well secured BEFORE using.

Benches supplied by Yamaha are designed for seating only. No other uses are recommended.

NOTICE:

Service charges incurred due to a lack of knowledge relating to how a function or effect works (when the unit is operating as designed) are not covered by the manufacturer's warranty, and are therefore the owners responsibility. Please study this manual carefully and consult your dealer before requesting service.

ENVIRONMENTAL ISSUES:

Yamaha strives to produce products that are both user safe and environmentally friendly. We sincerely believe that our products and the production methods used to produce them, meet these goals. In keeping with both the letter and the spirit of the law, we want you to be aware of the following:

Battery Notice:

This product MAY contain a small non-rechargeable battery which (if applicable) is soldered in place. The average life span of this type of battery is approximately five years. When replacement becomes necessary, contact a qualified service representative to perform the replacement.

This product may also use "household" type batteries. Some of these may be rechargeable. Make sure that the battery being charged is a rechargeable type and that the charger is intended for the battery being charged.

When installing batteries, never mix old batteries with new ones, and never mix different types of batteries. Batteries MUST be installed correctly. Mismatches or incorrect installation may result in overheating and battery case rupture.

Warning:

Do not attempt to disassemble, or incinerate any battery. Keep all batteries away from children. Dispose of used batteries promptly and as regulated by the laws in your area. Note: Check with any retailer of household type batteries in your area for battery disposal information.

Disposal Notice:

Should this product become damaged beyond repair, or for some reason its useful life is considered to be at an end, please observe all local, state, and federal regulations that relate to the disposal of products that contain lead, batteries, plastics, etc. If your dealer is unable to assist you, please contact Yamaha directly.

NAME PLATE LOCATION:

The name plate is located on the bottom of the product. The model number, serial number, power requirements, etc., are located on this plate. You should record the model number, serial number, and the date of purchase in the spaces provided below and retain this manual as a permanent record of your purchase.

Model

Serial No.

Purchase Date

PLEASE KEEP THIS MANUAL

92-BP (bottom)

FCC INFORMATION (U.S.A.)

1. IMPORTANT NOTICE: DO NOT MODIFY THIS UNIT!

This product, when installed as indicated in the instructions contained in this manual, meets FCC requirements. Modifications not expressly approved by Yamaha may void your authority, granted by the FCC, to use the product.

2. IMPORTANT:

When connecting this product to accessories and/ or another product use only high quality shielded cables. Cable/s supplied with this product MUST be used. Follow all installation instructions. Failure to follow instructions could void your FCC authorization to use this product in the USA.

3. NOTE:

This product has been tested and found to comply with the requirements listed in FCC Regulations, Part 15 for Class "B" digital devices. Compliance with these requirements provides a reasonable level of assurance that your use of this product in a residential environment will not result in harmful interference with other electronic devices. This equipment generates/uses radio frequencies and, if not installed and used according to the instructions found in the users manual, may cause interference harmful to the operation of other electronic devices. Compliance with FCC regulations does

not guarantee that interference will not occur in all installations. If this product is found to be the source of interference, which can be determined by turning the unit "OFF" and "ON", please try to eliminate the problem by using one of the following measures:

Relocate either this product or the device that is being affected by the interference.

Utilize power outlets that are on different branch (circuit breaker or fuse) circuits or install AC line filter/s.

In the case of radio or TV interference, relocate/reorient the antenna. If the antenna lead-in is 300 ohm ribbon lead, change the lead-in to co-axial type cable.

If these corrective measures do not produce satisfactory results, please contact the local retailer authorized to distribute this type of product. If you can not locate the appropriate retailer, please contact Yamaha Corporation of America, Electronic Service Division, 6600 Orangethorpe Ave, Buena Park, CA90620

The above statements apply ONLY to those products distributed by Yamaha Corporation of America or its subsidiaries.

* This applies only to products distributed by YAMAHA CORPORATION OF AMERICA.

(class B)

**COMPLIANCE INFORMATION STATEMENT
(DECLARATION OF CONFORMITY PROCEDURE)**

Responsible Party : Yamaha Corporation of America
Address : 6600 Orangethorpe Ave., Buena Park, Calif.
90620
Telephone : 714-522-9011
Type of Equipment : Digital Piano
Model Name : DGX-650

This device complies with Part 15 of the FCC Rules.
Operation is subject to the following two conditions:
1) this device may not cause harmful interference, and
2) this device must accept any interference received including
interference that may cause undesired operation.
See user manual instructions if interference to radio reception is
suspected.

* This applies only to products distributed by (FCC DoC)
YAMAHA CORPORATION OF AMERICA.

OBSERVERA!

Apparaten kopplas inte ur växelströmskällan (nätet) så länge som den
är ansluten till vägguttaget, även om själva apparaten har stängts av.

ADVARSEL: Netspændingen til dette apparat er IKKE afbrudt,
så længe netledningen sidder i en stikkontakt, som er tændt — også
selvom der er slukket på apparatets afbryder.

VAROITUS: Laitteen toisiopiiriin kytketty käyttökytkin ei irroita koko
laitetta verkosta.

(standby)

The model number, serial number, power requirements, etc., may be
found on or near the name plate, which is at the bottom of the unit.
You should note this serial number in the space provided below and
retain this manual as a permanent record of your purchase to aid
identification in the event of theft.

Model No.

Serial No.

(bottom_en_01)

Information for Users on Collection and Disposal of Old Equipment



This symbol on the products, packaging, and/or accompanying documents means that used electrical and electronic products should not be mixed with general household waste.

For proper treatment, recovery and recycling of old products, please take them to applicable collection points, in accordance with your national legislation and the Directives 2002/96/EC.

By disposing of these products correctly, you will help to save valuable resources and prevent any potential negative effects on human health and the environment which could otherwise arise from inappropriate waste handling.

For more information about collection and recycling of old products, please contact your local municipality, your waste disposal service or the point of sale where you purchased the items.

[For business users in the European Union]

If you wish to discard electrical and electronic equipment, please contact your dealer or supplier for further information.

[Information on Disposal in other Countries outside the European Union]

This symbol is only valid in the European Union. If you wish to discard these items, please contact your local authorities or dealer and ask for the correct method of disposal.

(weee_eu_en_01)

Table of Contents

Setting Up	
Special Features	5
PRECAUTIONS	6
Compatible Format	8
About Manuals	9
Included Accessories	9
Keyboard Stand Assembly	10
Panel Controls and Terminals	
Front Panel	14
Rear Panel	15
Setting Up	16
Power Requirements	16
Connecting a Footswitch (SUSTAIN Jack)	16
Connecting Headphones or External Audio Equipment (PHONES/OUTPUT Jack)	17
Connecting a Pedal Unit (PEDAL UNIT jack)	18
Connecting a Computer (USB TO HOST terminal)	19
Turning the Power On/Off	19
Setting the Volume	20
Auto Power Off Function	20
MAIN Display	21
Basic Controls	22
Basic Guide	
Try Playing a Variety of Instrument Voices	23
Selecting a Main Voice	23
Playing the "Grand Piano"	23
Layering Two Voices—Dual Voice	24
Playing a Split Voice in the Left Hand area	24
Using the Metronome	25
Adding Harmony	27
Playing Styles	28
Using the Music Database	29
Chords	30
Using the Smart Chord feature	31
Calling up Optimum Styles for Your Performance (Style Recommender)	33
Playing Songs and Audio Files	34
Listening to the Overview Demo	34
Playing Back a Song or Audio File	35
Fast Forward, Rewind, and Pause	36
A-B Repeat	36
Turning Each Track On/Off	36
Displaying the Song Score	37
Displaying the Lyrics	37
Using the Song Lesson Feature	38
Three Types of Song Lesson	38
Practicing with Song Lesson	38
Making Practice Perfect—Repeat & Learn	39
Recording Your Performance	40
Song Recording	40
Recording to a Specified Track	42
Clearing a User Song	44
Clearing a Specified Track from a User Song	44
Audio Recording	45
Memorizing Your Favorite Panel Settings	46
Memorizing Panel Settings to the Registration Memory	46
Recalling Panel Settings from the Registration Memory	47

Playing Audio Files via an External Audio Player	48
Backup Parameters and Initialization	
Backup Parameters	49
Initialization	49

Reference

Handy Performance Features	50
Selecting a Reverb Type	50
Selecting a Chorus Type	50
Selecting a DSP Type	51
Panel Sustain	52
Pitch Controls—Transpose	52
Pitch Controls—Tuning	53
Pitch Controls—the PITCH BEND wheel	53
Touch Response Sensitivity	54
Selecting an EQ Setting for the Best Sound	54
Setting the Output Gain Level	55
Speaker On/Off Setting	55
Intelligent Acoustic Control (IAC)	56
Voice Settings	57
Selecting a Dual Voice	57
Selecting a Split Voice	57
Voice Editing	57
Style (Auto Accompaniment) Functions	58
Style Variations—Sections	58
Changing the Tempo	60
Adjusting the Volume of the Style	60
Playing Chords Without Style Playback	60
Setting the Split Point	61
Setting the Chord Fingering	61
Looking Up Chords Using the Chord Dictionary	62
Song and Audio Settings	63
Background Music (BGM) Playback	63
Random Playback	63
Tempo Setting of the Song	64
Song Volume	64
Audio Volume	64
Changing the Voice of the Song	65
Specifying the Channel for the Lesson Part	65
The Functions	66
Function List	67
USB Flash Memory Operations	70
Connecting a USB Flash Memory	71
Formatting a USB Flash Memory	72
Saving a Registration Memory to USB Flash Memory	73
Saving a User Song to USB Flash Memory	74
Converting a User Song to an Audio file	75
Loading Files from a USB Flash Memory	76
Deleting files from a USB Flash Memory	77
Deleting User Data from the Instrument	77
Appendix	
Troubleshooting	78
Messages	79
Specifications	80
Index	82

Special Features

Natural Piano Voice ► Page 23

The DGX-650 features an amazingly realistic piano Voice (“Natural! Grand Piano”; Voice 001) meticulously sampled from a concert grand piano—fantastic for playing not only classical compositions but also piano pieces in any style. No matter what instrument settings have been made, you can instantly call up the Piano Voice by simply pressing the [PORTABLE GRAND] button.

Graded Hammer Standard Keyboard

Thanks to our experience as the world’s leading manufacturer of acoustic pianos, we’ve developed a keyboard with action that’s virtually indistinguishable from the real thing. Just as on a traditional acoustic piano, the keys of the lower notes have a heavier touch, while the higher ones are more responsive to lighter playing. The keyboard’s sensitivity can even be adjusted to match your playing style. This Graded Hammer technology gives the DGX-650 remarkably authentic touch in a lightweight instrument.

Amazingly Realistic and Dynamic Sounds ► Page 23

Yamaha’s authentic Voices (especially the highly acclaimed Live!, Sweet! and Cool! Voices) deliver incredibly natural and dynamic sound—with all the nuances of the original instrument, from delicate to powerful.

Play Along with Styles ► Page 28

The DGX-650 also has complete and fully automatic accompaniment features with the Styles. These Styles provide the equivalent of a full backing band covering wide variety of genres—from waltz and swing to 8-beat and euro-trance, plus much more. Select a Style that matches the music you want to play, or experiment with new Styles to expand your musical horizons. And if it’s difficult to select the right Style from the huge variety available, use the Style Recommender function, which calls up a list of suggested Styles, based on a sample rhythm you play. Also, this instrument features a Smart Chord function, allowing you to simply press single keys, and yet play various chord progressions that authentically match the music genre and key you specify—giving you even greater enjoyment from the Styles!

Easy Performance with Music Notation Display ► Page 37

When you play back a Song, the corresponding score is shown on the display. This is a great way to learn how to read music. If the Song contains lyric and chord data, the lyrics and chords also appear in the score.

USB TO DEVICE ► Page 70

Connect a USB flash memory device to the USB TO DEVICE terminal on the instrument, and save or load registrations, and User Songs that you’ve created on the instrument, as well as read data from the device, such as MIDI files or Style files.

Also, Audio files (.wav) stored to USB flash memory can be played back on the instrument. Moreover, you can record your performance as Audio data to a USB flash memory device. For more on Audio playing and recording, see pages 34 and 40.

PRECAUTIONS

PLEASE READ CAREFULLY BEFORE PROCEEDING

Please keep this manual in a safe and handy place for future reference.



WARNING

Always follow the basic precautions listed below to avoid the possibility of serious injury or even death from electrical shock, short-circuiting, damages, fire or other hazards. These precautions include, but are not limited to, the following:

Power supply/AC power adaptor

- Do not place the power cord near heat sources such as heaters or radiators. Also, do not excessively bend or otherwise damage the cord, or place heavy objects on it.
- Only use the voltage specified as correct for the instrument. The required voltage is printed on the name plate of the instrument.
- Use the specified adaptor (page 81) only. Using the wrong adaptor can result in damage to the instrument or overheating.
- Check the electric plug periodically and remove any dirt or dust which may have accumulated on it.

Do not open

- This instrument contains no user-serviceable parts. Do not open the instrument or attempt to disassemble or modify the internal components in any way. If it should appear to be malfunctioning, discontinue use immediately and have it inspected by qualified Yamaha service personnel.

Water warning

- Do not expose the instrument to rain, use it near water or in damp or wet conditions, place on it any containers (such as vases, bottles or glasses) containing liquids which might spill into any openings. If any liquid such as water seeps into the instrument, turn off the power immediately and unplug the power cord from the AC outlet. Then have the instrument inspected by qualified Yamaha service personnel.
- Never insert or remove an electric plug with wet hands.

Fire warning

- Do not put burning items, such as candles, on the unit. A burning item may fall over and cause a fire.

If you notice any abnormality

- When one of the following problems occur, immediately turn off the power switch and disconnect the electric plug from the outlet. Then have the device inspected by Yamaha service personnel.
 - The power cord or plug becomes frayed or damaged.
 - It emits unusual smells or smoke.
 - Some object has been dropped into the instrument.
 - There is a sudden loss of sound during use of the instrument.



CAUTION

Always follow the basic precautions listed below to avoid the possibility of physical injury to you or others, or damage to the instrument or other property. These precautions include, but are not limited to, the following:

Power supply/AC power adaptor

- Do not connect the instrument to an electrical outlet using a multiple-connector. Doing so can result in lower sound quality, or possibly cause overheating in the outlet.
- When removing the electric plug from the instrument or an outlet, always hold the plug itself and not the cord. Pulling by the cord can damage it.
- Remove the electric plug from the outlet when the instrument is not to be used for extended periods of time, or during electrical storms.

Assembly

- Read carefully the attached documentation explaining the assembly process. Failure to assemble the instrument in the proper sequence might result in damage to the instrument or even injury.

Location

- Do not place the instrument in an unstable position where it might accidentally fall over.
- When transporting or moving the instrument, always use two or more people. Attempting to lift the instrument by yourself may damage your back, result in other injury, or cause damage to the instrument itself.
- Before moving the instrument, remove all connected cables, to prevent damage to the cables or injury to anyone who might trip over them.
- When setting up the product, make sure that the AC outlet you are using is easily accessible. If some trouble or malfunction occurs, immediately turn off the power switch and disconnect the plug from the outlet. Even when the power switch is turned off, electricity is still flowing to the product at the minimum level. When you are not using the product for a long time, make sure to unplug the power cord from the wall AC outlet.
- Use only the stand specified for the instrument. When attaching the stand or rack, use the provided screws only. Failure to do so could cause damage to the internal components or result in the instrument falling over.

Connections

- Before connecting the instrument to other electronic components, turn off the power for all components. Before turning the power on or off for all components, set all volume levels to minimum.
- Be sure to set the volumes of all components at their minimum levels and gradually raise the volume controls while playing the instrument to set the desired listening level.

Handling caution

- Do not insert a finger or hand in any gaps on the instrument.
- Never insert or drop paper, metallic, or other objects into the gaps on the panel. This could cause physical injury to you or others, damage to the instrument or other property, or operational failure.
- Do not rest your weight on, or place heavy objects on the instrument, and do not use excessive force on the buttons, switches or connectors.
- Do not use the instrument/device or headphones for a long period of time at a high or uncomfortable volume level, since this can cause permanent hearing loss. If you experience any hearing loss or ringing in the ears, consult a physician.

Yamaha cannot be held responsible for damage caused by improper use or modifications to the instrument, or data that is lost or destroyed.

Always turn the power off when the instrument is not in use.

Even when the [] (Standby/On) switch is in standby status (display is off), electricity is still flowing to the instrument at the minimum level.

When you are not using the instrument for a long time, make sure you unplug the power cord from the wall AC outlet.

NOTICE

To avoid the possibility of malfunction/ damage to the product, damage to data, or damage to other property, follow the notices below.

■ Handling and Maintenance

- Do not use the instrument in the vicinity of a TV, radio, stereo equipment, mobile phone, or other electric devices. Otherwise, the instrument, TV, or radio may generate noise. When you use the instrument along with the application on your iPhone/iPad, we recommend that you set "Airplane Mode" to "ON" on your iPhone/iPad in order to avoid noise caused by communication.
- Do not expose the instrument to excessive dust or vibrations, or extreme cold or heat (such as in direct sunlight, near a heater, or in a car during the day) to prevent the possibility of panel discoloration, damage to the internal components or unstable operation. (Verified operating temperature range: 5° – 40°C, or 41° – 104°F.)
- Do not place vinyl, plastic or rubber objects on the instrument, since this might discolor the panel or keyboard.
- When cleaning the instrument, use a soft, dry cloth. Do not use paint thinners, solvents, cleaning fluids, or chemical-impregnated wiping cloths.
- During extreme changes in temperature or humidity, condensation may occur and water may collect on the surface of the instrument. If water is left, the wooden parts may absorb the water and be damaged. Make sure to wipe any water off immediately with a soft cloth.

■ Saving data

- Some data items (page 49) are automatically saved as backup data in the internal memory even if you turn the power off. Saved data may be lost due to malfunction or incorrect operation. Save important data to external device such as a USB flash memory (pages 73–75).
- The recorded Songs are lost when you turn off the power of the instrument without saving. It occurs also when the power is turned off by Auto Power Off function (page 20). Save the recorded data to the instrument.

Information

■ About copyrights

- Copying of the commercially available musical data including but not limited to MIDI data and/or audio data is strictly prohibited except for your personal use.
- This product incorporates and bundles computer programs and contents in which Yamaha owns copyrights or with respect to which it has license to use others' copyrights. Such copyrighted materials include, without limitation, all computer software, style files, MIDI files, WAVE data, musical scores and sound recordings. Any unauthorized use of such programs and contents outside of personal use is not permitted under relevant laws. Any violation of copyright has legal consequences. DON'T MAKE, DISTRIBUTE OR USE ILLEGAL COPIES.

■ About functions/data bundled with the instrument

- Some of the preset songs have been edited for length or arrangement, and may not be exactly the same as the original.

■ About this manual

- The illustrations and LCD screens as shown in this manual are for instructional purposes only, and may appear somewhat different from those on your instrument.
- Apple, iPhone, iPod touch and iPad are trademarks of Apple Inc., registered in the U.S. and other countries.
- The company names and product names in this manual are the trademarks or registered trademarks of their respective companies.

Compatible Format



GM System Level 1

“GM System Level 1” is an addition to the MIDI standard which ensures that any GM-compatible music data can be accurately played by any GM-compatible tone generator, regardless of manufacturer. The GM mark is affixed to all software and hardware products that support GM System Level.



XF

The Yamaha XF format enhances the SMF (Standard MIDI File) standard with greater functionality and open-ended expandability for the future. The instrument is capable of displaying lyrics when an XF file containing lyric data is played.



STYLE FILE

The Style File Format is Yamaha’s original style file format which uses a unique conversion system to provide high-quality automatic accompaniment based on a wide range of chord types.



XGlite

As its name implies, “XGlite” is a simplified version of Yamaha’s high-quality XG tone generation format. Naturally, you can play back any XG song data using an XGlite tone generator. However, keep in mind that some songs may play back differently compared to the original data, due to the reduced set of control parameters and effects.

About Manuals

This instrument has the following documents and instructional materials.

■ Included Documents



Owner's Manual (this book)

- Setting Up Please read this section first.
- Basic Guide This section explains how to use the basic functions. Refer to this section while playing the instrument.
- Reference This section explains how to make detailed settings for the various functions of the instrument.
- Appendix This section includes troubleshooting information and specifications.



Data List

Contains various important preset content lists such as those of Voices, Styles, and Effects.

■ Online Materials (from Yamaha Downloads)



MIDI Reference

Contains MIDI related information such as MIDI Data Format and the MIDI Implementation Chart.



MIDI Basics (only in English, French, German and Spanish)

Contains basic explanations about MIDI.



Computer-related Operations

Includes instructions on connecting this instrument to a computer, and operations related to transferring files and MIDI data.

To obtain these manuals, access the Yamaha Downloads website, select your country, enter “DGX-650” in the Model Name box, then click [Search].

Yamaha Downloads <http://download.yamaha.com/>

■ Online Material (for Yamaha Online members)



Song Book (only in English, French, German and Spanish)

Contains music scores for the preset Songs (excluding the Over View Demo Song and Songs 1–11) of this instrument. After completing the user registration at the website below, you can download this Song Book free of charge.

Yamaha Online Member <https://member.yamaha.com/myproduct/regist/>

You will need the PRODUCT ID on the sheet “Online Member Product Registration” packaged with this manual in order to fill out the User Registration form.

Included Accessories

- Owner's Manual (this book)
- Data List
- Keyboard Stand
- Footswitch
- Music Rest
- AC Power Adaptor *1
- Online Member Product Registration *2

*1: May not be included depending on your particular locale. Check with your Yamaha dealer.

*2: The PRODUCT ID on the sheet will be needed when you fill out the User Registration form.

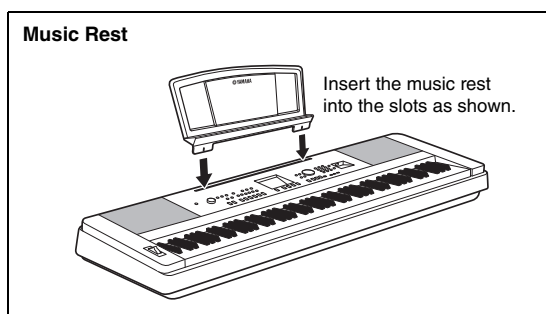

Keyboard Stand Assembly

CAUTION

Read these cautions carefully before you assemble or use the keyboard stand. These cautions are to promote safe use of the stand and to prevent injury and damage from occurring to you and others. By following these cautions carefully, your keyboard stand will provide you with safe and prolonged use.

- Be careful not to confuse parts, and be sure to install all parts in the correct direction. Please assemble in accordance with the sequence given below.
- Assembly should be carried out by at least two persons.
- Be sure to use the correct screw size, as indicated below. Use of incorrect screws can cause damage.
- Use the stand after assembly is complete. An uncompleted stand may overturn or the keyboard may drop.
- Always place the stand on a flat, stable surface. Placing the stand on uneven surfaces may cause it to become unstable or overturn, the keyboard to drop, or injury.
- Do not use the stand for anything other than its designed purpose. Placing other objects on the stand may result in the object dropping or the stand overturning.
- Do not apply excessive force to the keyboard as it may cause the stand to overturn or the keyboard to drop.
- Make sure the stand is sturdy and safe, and all screws have been tight and firm before use. If not, the stand may overturn, the keyboard may drop, or may result in injury to the user.
- To disassemble, reverse the assembly sequence given below.

Have a phillips-head (+) screwdriver of the appropriate size ready.

1 The parts shown in the “Assembly Parts” illustration will be used. Follow the assembly instructions and select the parts as needed.

1

Assembly Parts

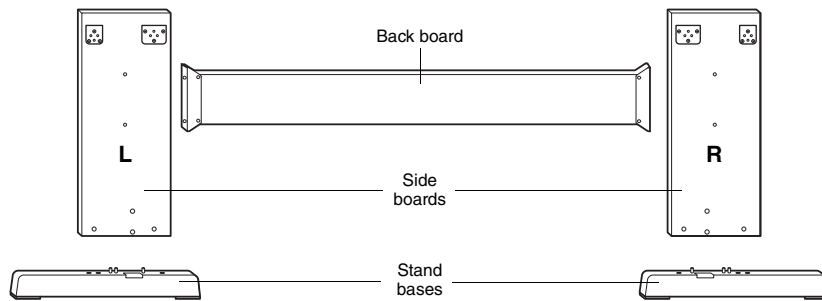

A (1 pc.) B (1 pc.) C (2 pcs.)



1 Joint connectors
(4 pcs.)



2 Metal brackets



3 3 x 8 mm roundhead
screws (12 pcs.)



4 6 x 70 mm roundhead
screws (4 pcs.)



5 6 x 30 mm roundhead
screws (4 pcs.)



6 5 x 16 mm roundhead
screws (4 pcs.)

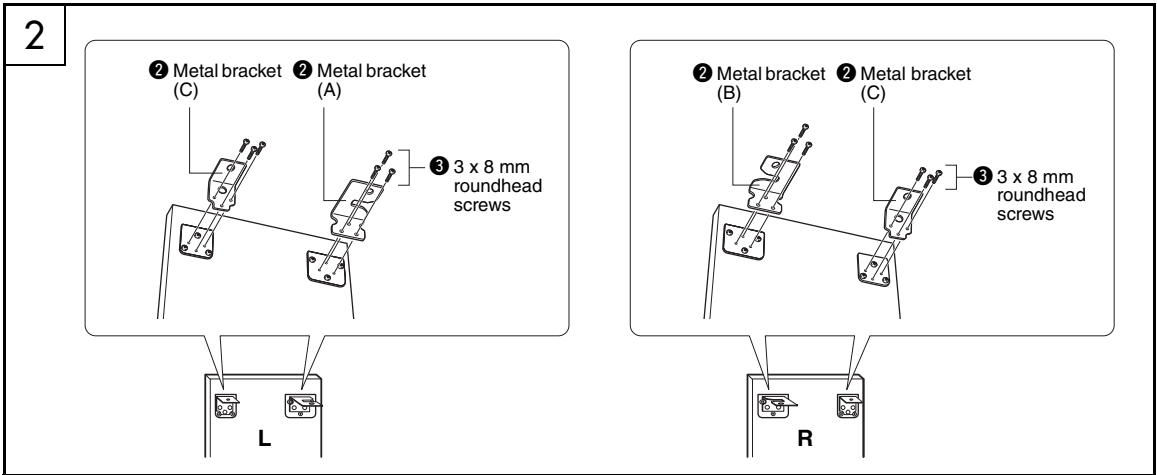

2 Attach the metal brackets.

Attach the metal brackets ② to the top of the side boards, using the screws ③ as shown.

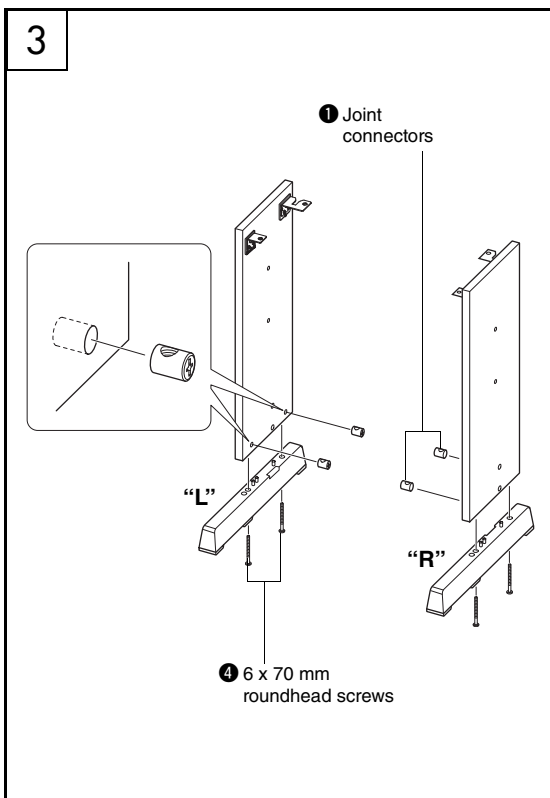

3 Attach the stand bases.

Insert the joint connectors ① into the side boards as shown. The joint connectors have been installed properly if you can see the screw head on the connector.

NOTE

- If you put the connectors in wrong direction and want to take them out, tap around the holes on the boards.

Attach the “L” (Left) and “R” (Right) stand bases to the bottom of the side boards, using the screws ④. “L” (Left) and “R” (Right) are marked on the upper surfaces of the stand bases. If you have trouble fastening the screws, use a screwdriver to rotate the joint connectors so that the connector holes are aligned with the screw holes on the stand bases.

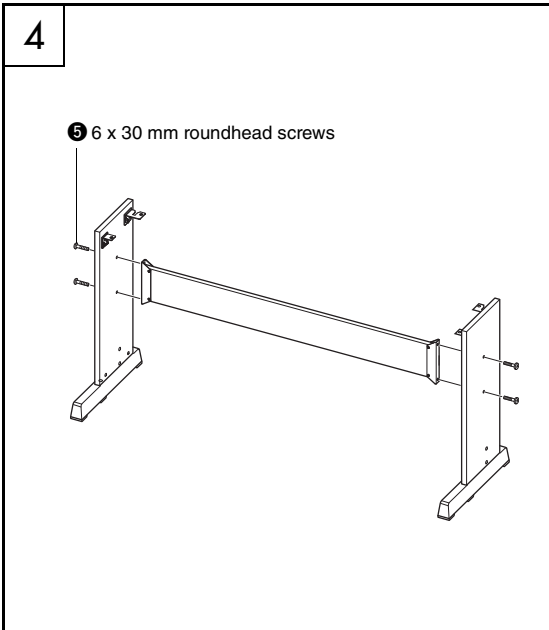

4 Attach the back board.

Attach the back board, using the screws ⑤. Check the back-to-front orientation for the side boards. Make sure the non-colored surface is facing down.

⚠ CAUTION

- Be careful not to drop the back board or touch the sharp metal fittings.

NOTE

- If you have purchased an optional pedal unit, attach the pedal unit before proceeding to the next step. Refer to the instructions provided with your pedal unit.

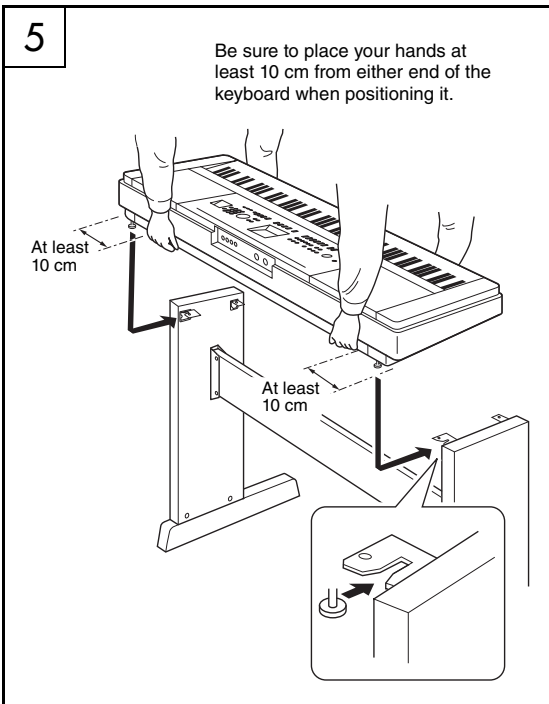

5 Put the keyboard on the stand.

Check the back-to-front orientation for stand, and carefully place the keyboard on the side boards. Slowly move the keyboard so that the holes on the bottom of the keyboard are properly aligned with the holes on the angle brackets.

⚠ CAUTION

- Be careful not to drop the keyboard or to get your fingers caught between the keyboard and the stand parts.
- Do not hold the keyboard in any position other than the position shown in the illustration.

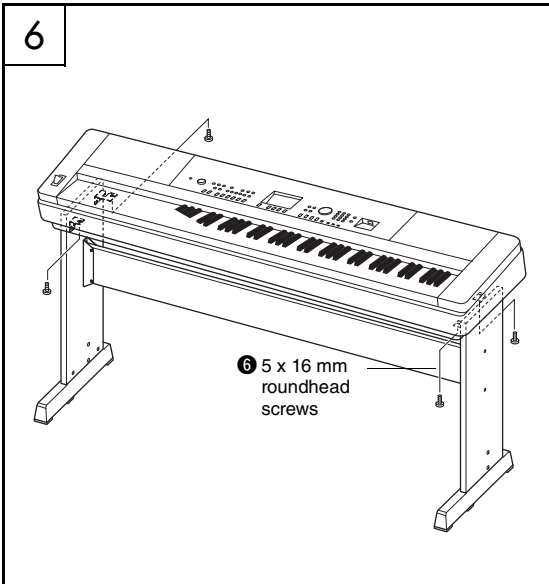

6 Install the keyboard to the stand.

Fix the keyboard to the angle brackets, using the screws **6**.

Post-assembly checklist

Once you've assembled the stand, check the following points:

- Are there any parts left over?
→ If so, read the assembly instructions again and correct any errors you might have made.
- Is the instrument clear of doors and other movable fixtures?
→ If not, move the instrument to an appropriate location.
- Does the instrument make a rattling noise when you play it or move it?
→ If so, properly tighten all screws.
- Also, if the keyboard makes a creaking noise or seems unsteady when you play it, refer carefully to the assembly instructions and diagrams and retighten all screws.

Panel Controls and Terminals

Front Panel

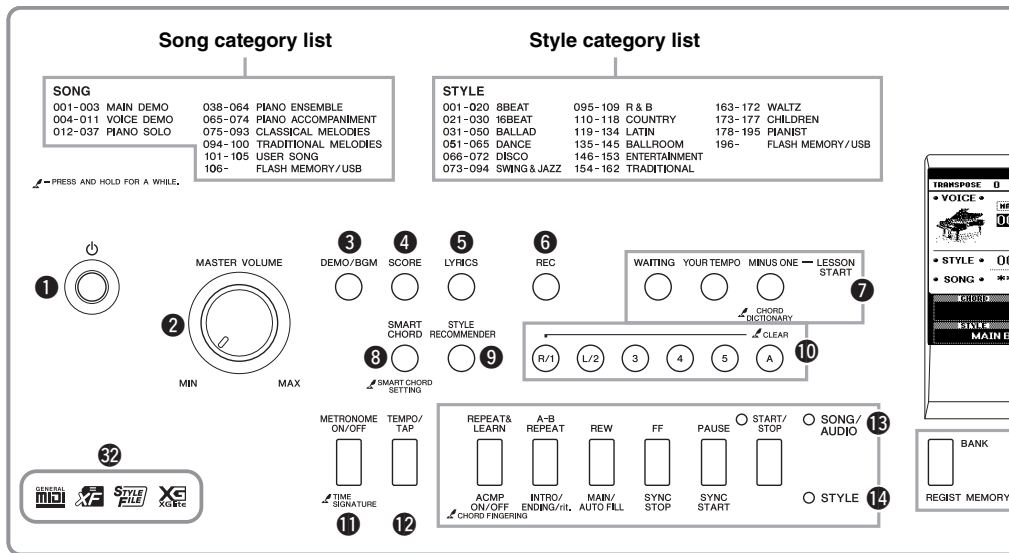

Front Panel

- ① [⏻] (Standby/On) switch..... page 19
- ② [MASTER VOLUME] control page 20
- ③ [DEMO/BGM] button pages 34, 63
- ④ [SCORE] button..... page 37
- ⑤ [LYRICS] button..... page 37
- ⑥ [REC] button..... pages 40, 42, 45
- ⑦ LESSON START
 - [WAITING] button..... page 39
 - [YOUR TEMPO] button page 39
 - [MINUS ONE] button..... page 39
- ⑧ [SMART CHORD] button..... page 31
- ⑨ [STYLE RECOMMENDER] button page 33
- ⑩ Song Track
 - [1]–[5], [A] buttons..... page 36
- Lesson
 - [R] and [L] buttons page 38
- ⑪ [METRONOME ON/OFF] button page 25
- ⑫ [TEMPO/TAP] button..... pages 60, 64
- ⑬ SONG/AUDIO
 - [REPEAT&LEARN] button..... page 39
 - [A-B REPEAT] button..... page 36
 - [REW] button..... page 36
 - [FF] button..... page 36
 - [PAUSE] button page 36
 - [START/STOP] button page 35
- ⑭ STYLE
 - [ACMP ON/OFF] button page 28
 - [INTRO/ENDING/rit.] button page 58
 - [MAIN/AUTO FILL] button page 58
 - [SYNC STOP] button page 59
 - [SYNC START] button..... page 29
 - [START/STOP] button..... page 29
- ⑮ REGIST MEMORY
 - [BANK], [1]–[4] buttons..... page 46
- ⑯ CATEGORY [◀] and [▶] buttons page 22
- ⑰ [EXIT] button page 21
- ⑱ [EXECUTE] button page 72
- ⑲ DATA ENTRY
 - Dial, Number buttons [0]–[9],
 - [+] and [-] buttons page 22
- ⑳ [FILE CONTROL] button..... page 72
- ㉑ [FUNCTION] button..... page 66
- ㉒ [PORTABLE GRAND] button..... page 23
- ㉓ [SONG/AUDIO] button page 35
- ㉔ [STYLE] button page 28
- ㉕ [VOICE] button page 23
- ㉖ [MUSIC DATABASE] button..... page 29
- ㉗ [SPLIT ON/OFF] button page 24
- ㉘ [DUAL ON/OFF] button page 24
- ㉙ [HARMONY ON/OFF] button page 27
- ㉚ [PITCH BEND] wheel page 53
- ㉛ USB TO DEVICE terminal pages 70, 71
- ㉜ Compatible Formats page 8

Display (page 21)

Voice category list

VOICE	064-079 STRINGS	123-131 SYNTH LEAD
001-009 PIANO	080-083 CHOIR	132-139 SYNTH PAD
010-021 E.PIANO	084-096 SAXOPHONE	140-147 PERCUSSION
022-035 ORGAN	097-105 TRUMPET	148-162 DRUM KITS
036-040 ACCORDION	106-115 BRASS	163-543 XG1 [®]
041-054 GUITAR	116-122 FLUTE	000 OTS

Music Database category list

MUSIC DATABASE	133-141 DISCO	238-245 WALTZ
001-015 MODERN POP	142-161 SWING & JAZZ	246-274 WORLD&TRADITIONAL
016-048 80S POP	162-184 R & B	275-305 PIANIST
049-076 70S POP	185-198 COUNTRY	
077-110 60S & 50S POP	199-213 LATIN	
111-122 ROCK	214-237 ENTERTAINMENT	

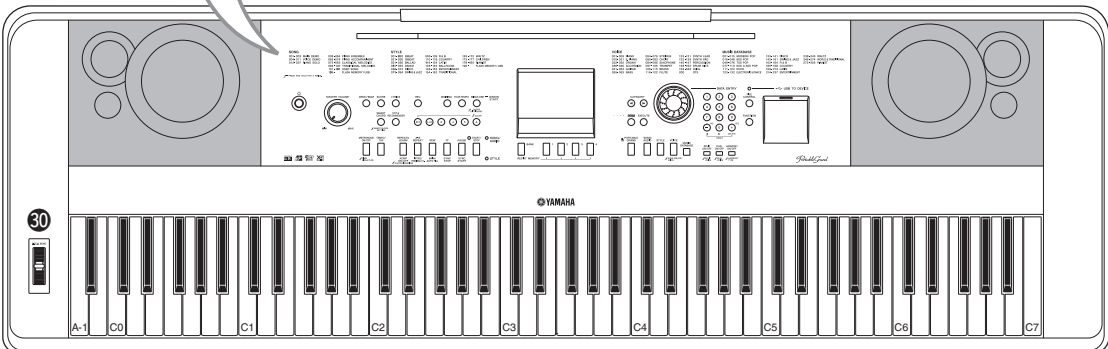

Rear Panel

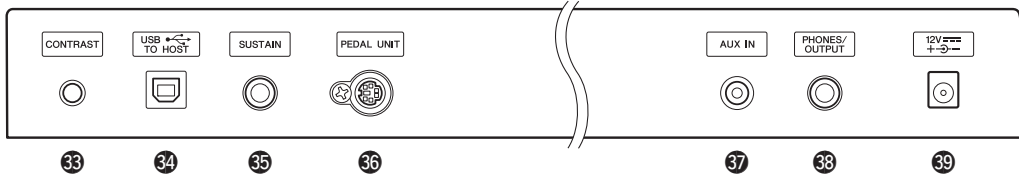

Rear Panel

- 33 CONTRAST knobpage 21
- 34 USB TO HOST terminal..... pages 19, 68
- 35 SUSTAIN jack page 16
- 36 PEDAL UNIT jack page 18
- 37 AUX IN jack.....page 48
- 38 PHONES/OUTPUT jack..... page 17
- 39 DC IN jack..... page 16

“Press & Hold” symbol
 By holding down one of the buttons having this symbol, you can call up an alternate function, other than the one called up when simply pressing.

Setting Up

Power Requirements

⚠ WARNING

- Use the specified adaptor (page 81) only. Using the wrong adaptor can result in damage to the instrument or overheating.

- 1 Connect the AC power adaptor to the DC IN jack.
- 2 Plug the AC power adaptor into an AC outlet.

⚠ CAUTION

- Unplug the AC Power Adaptor when not using the instrument, or during electrical storms, to avoid the possibility of physical injury to you or others, or damage to the instrument or other property.

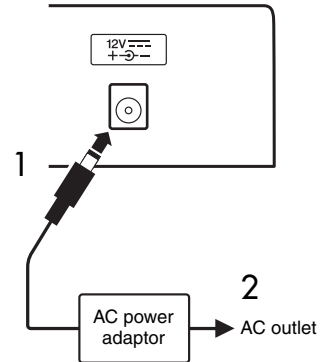

⚠ CAUTION

- Before connecting the instrument to other electronic components, turn off the power of all the components. Also, before turning any components on or off, make sure to set all volume levels to minimum (0). Otherwise, damage to the components, electrical shock, or even permanent hearing loss may occur.

Connecting a Footswitch (SUSTAIN Jack)

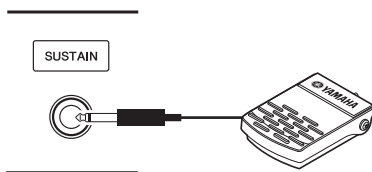

The sustain function lets you produce a natural sustain as you play by pressing a footswitch. Plug the supplied footswitch into this jack and use it to switch sustain on and off.

Damper Resonance

This function simulates the sustain sound produced with the damper pedal on a grand piano. If you want to use this function, select Voice 001 (page 23), then press the Footswitch. This function can be turned off via the FUNCTION display (page 68).

NOTE

- The sustain function does not affect the Split Voice (page 24).
- Make sure that the footswitch plug is properly connected to the SUSTAIN jack before turning on the power.
- Do not press the footswitch while turning the power on. Doing this changes the recognized polarity of the footswitch, resulting in reversed footswitch operation.

Connecting Headphones or External Audio Equipment (PHONES/OUTPUT Jack)

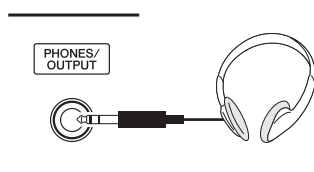

Headphones

Any pair of stereo headphones with a standard stereo phone plug can be plugged in here for convenient monitoring. The speakers are automatically shut off when a plug is inserted into this jack. This setting can be changed so that speaker sound is always on regardless whether a plug is inserted or not (page 55).

External Audio Equipment

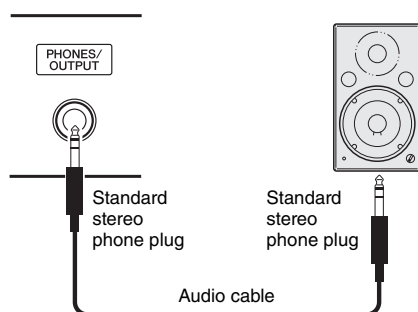

The PHONES/OUTPUT jack also functions as an external output. You can connect the PHONES/OUTPUT jack to a keyboard amplifier, stereo system, mixer, tape recorder, or other line-level audio device to send the instrument's output signal to that device.

Optimum setting

Output gain level for this jack is set to a value suitable for connecting headphones, as the default setting. You can switch this to the value suitable for connecting an external audio device. For details on how to switch the value, see page 55.

CAUTION

- Do not use the instrument/device or headphones for a long period of time at a high or uncomfortable volume level, since this can cause permanent hearing loss. If you experience any hearing loss or ringing in the ears, consult a physician.

NOTICE

- When the instrument's sound is output to an external device, first turn on the power to the instrument, then to the external device. Reverse this order when you turn the power off. If the instrument's power is automatically turned off via the Auto Power Off function (page 20), first turn off the external device, then turn on the power to the instrument then the external device again.

NOTICE

- Do not route the output from the PHONES/OUTPUT jack to the AUX IN jack. If you make this connection, the signal input at the AUX IN jack is output from the PHONES/OUTPUT jack. These connections could result in a feedback loop that will make normal performance impossible, and may even damage both pieces of equipment.

NOTE

- Use audio cables and adaptor cables having no (zero) resistance.

Connecting a Pedal Unit (PEDAL UNIT jack)

This jack is for connecting an optional LP-7A/LP-7AWH pedal unit. When connecting the pedal unit, make sure to also assemble the unit on the supplied keyboard stand.

NOTE

- Make sure that power is off when connecting or disconnecting the pedal.
- This affects only Main/Dual Voices and Harmony sound (pages 23, 24 and 27).

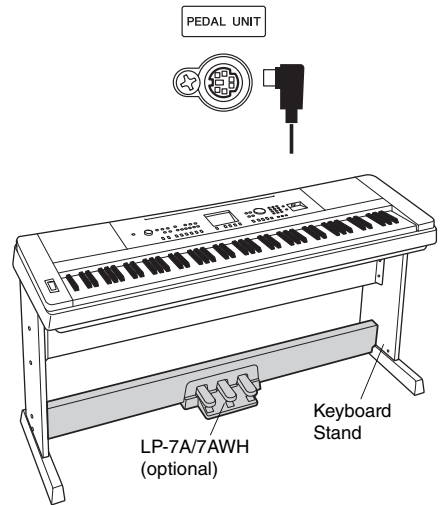

Pedal Unit functions

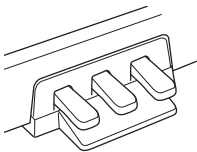

Damper Pedal (Right)

Pressing this pedal will sustain notes longer. Releasing this pedal immediately stops (damps) any sustained notes. A “half-pedal” function of this pedal creates partial sustain effects, depending on how far down you press the pedal. When using both a footswitch and pedal unit, the last effect applied takes priority.

Damper Resonance

This function simulates the sustain sound produced with a damper pedal on a grand piano. This effect is added when the Damper pedal is pressed for Voice 001. You can turn this function on or off via the FUNCTION display (page 68).

Sostenuto Pedal (Center)

If you play a note or notes on the keyboard and press the sostenuto pedal while the note(s) are held, those notes will sustain as long as you hold the pedal (as if the damper pedal had been pressed) but all subsequently played notes will not be sustained. This makes it possible to sustain a note or notes, for example, while other notes are played “staccato.”

Soft Pedal (Left)

The soft pedal reduces the volume and slightly changes the timbre of notes played while the pedal is pressed. The soft pedal will not affect notes that are already playing when it is pressed.

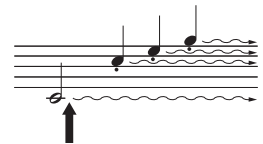

If you press and hold the damper pedal here, all the notes shown will be sustained.

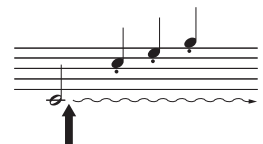

If you press and hold the sostenuto pedal here, only the notes held at this timing will be sustained.

CAUTION

- Before connecting the instrument to other electronic components, turn off the power of all the components. Also, before turning any components on or off, make sure to set all volume levels to minimum (0). Otherwise, damage to the components, electrical shock, or even permanent hearing loss may occur.

Connecting a Computer (USB TO HOST terminal)

By connecting a computer to the USB TO HOST terminal, you can transfer data between the instrument and the computer via MIDI. For details on using a computer with this instrument, refer to “Computer-related Operations” on the website (page 9).

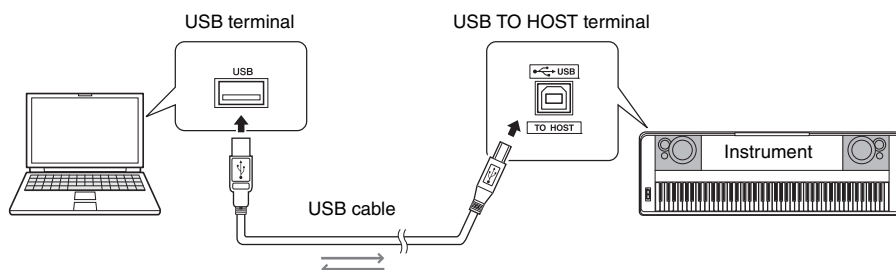
**NOTICE**

- Use an AB type USB cable of less than 3 meters. USB 3.0 cables cannot be used.

NOTE

- The instrument will begin transmission a short time after the USB connection is made.
- When using a USB cable to connect the instrument to your computer, make the connection directly without passing through a USB hub.
- For information on setting up your sequence software, refer to the owner's manual of the relevant software.

iPhone/iPad Connection

By connecting your iPhone or iPad to the USB TO HOST terminal of this instrument and using applications, you can manage your music files more easily and take advantage various functions. For details on connection, refer to “iPhone/iPad Connection Manual” downloadable from the website “Yamaha Downloads” (page 9).

For information about available applications, access the following page:

<http://www.yamaha.com/kbdapps/>

Turning the Power On/Off

Turn down the MASTER VOLUME control to “MIN” then press the [⏻] (Standby/On) switch to turn on the power. While playing the keyboard, adjust the MASTER VOLUME control. To turn off the power, press the [⏻] (Standby/On) switch again for a second.

CAUTION

- When using a power adaptor, even when the power is off, a small amount of electricity is still being consumed by the instrument. When you are not using the instrument for a long time, make sure to unplug the AC power adaptor from the wall AC outlet.

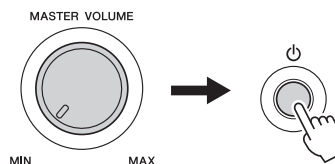

Setting the Volume

To adjust the volume level of the entire keyboard sound, use the MASTER VOLUME control located at the left of the panel. Play the keyboard to actually produce sound while you adjusting the volume to the desired level.

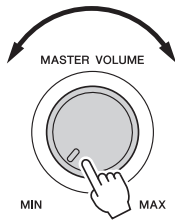

NOTE

- Adjusting the MASTER VOLUME control also affects the output level of the PHONES/OUTPUT jack.

CAUTION

- Do not use the instrument at a high volume level for a long period of time, or your hearing may be damaged.

Intelligent Acoustic Control (IAC)

IAC is a function which automatically adjusts and controls the sound quality according to the overall volume of the instrument. Even when the volume is low, it permits both low sounds and high sounds to be clearly heard. For details, refer to page 56.

Auto Power Off Function

To prevent unnecessary power consumption, this instrument features an Auto Power Off function that automatically turns the power off if the instrument is not operated for a specified period of time. The amount of time that will elapse before the power is automatically turned off is set by default to 30 minutes.

To disable the Auto Power Off function:

Turn off the power, then press the [⏻] (Standby/On) switch to turn on the power while holding down the lowest key. Make sure to hold down lowest key until a message appears at the top left of the display after pressing the power switch.

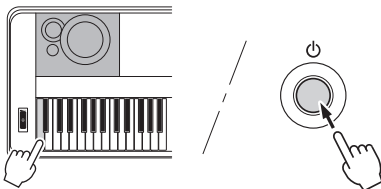

To set the time that elapses before Auto Power Off is executed:

Press the [FUNCTION] button, press the CATEGORY [◀◀] or [▶▶] button several times until “Auto Power Off” appears, then select the desired value by using the dial.

Settings: OFF, 5, 10, 15, 30, 60, 120

Default value: 30

NOTICE

- The recorded Song will be lost if the power is automatically turned off without executing the save operation. Make sure to save your recorded Song before the power turns off.
- Depending on the instrument status, the power may not turn off automatically, even after the elapse of the specified period of time. Always turn off the power manually when the instrument is not in use.
- When the instrument is not operated for a specified period of time while connected to an external device such as an amplifier, speaker or computer, make sure to follow the instructions in the Owner's Manual to turn off the power to the instrument and the connected devices, in order to protect the devices from damage. If you do not want the power to turn off automatically when a device is connected, disable Auto Power Off.

MAIN Display

When the power is turned on, the MAIN display automatically appears. This display shows the basic settings of the instrument, including the current Voice, Style, Song, Audio and other settings.

To Return to the MAIN Display
 You can return to the MAIN display from any other display by pressing the [EXIT] button.

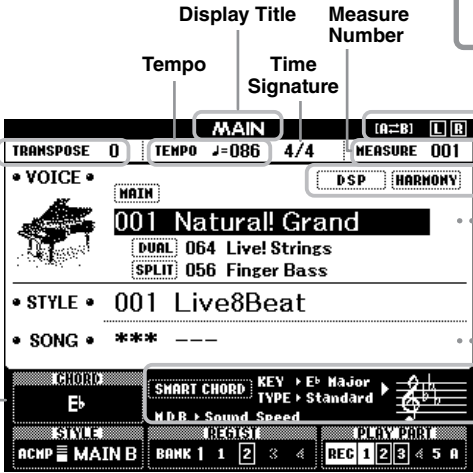

CONTRAST knob
 Adjust the CONTRAST knob on the rear panel of the instrument for optimum display legibility.

Transpose

TRANSPOSE 0

Tempo

TEMPO J=086

Time Signature

4/4

Measure Number

MEASURE 001

Style
 Indicates the current Style (page 28).

001 Natural! Grand

064 Live! Strings

056 Finger Bass

001 Live8Beat

Chord indication

E^b

SMART CHORD KEY ▶ E^b Major
 TYPE ▶ Standard

Style Status

ACMP MAIN B

ACMP Appears when Auto Accompaniment (ACMP) is on.

Appears when the Synchro Stop function is engaged.

MAIN B Shows section name

Registration Memory Status

BANK 1 1 2 3 4

BANK 1 Shows the selected bank number.

Shows the memory numbers that contain data. A border appears around the selected number.

A-B Repeat

[A=B] Appears when A-B Repeat playback is engaged.

Lesson part

[L R] Shows the current Lesson part

Appears when the corresponding function is turned on.

DSP Page 51

HARMONY Page 27

Voice

Indicates the current Voices (Main, Dual and Split) (pages 23, 24).

Song or Audio

Indicates the current Song or Audio file.

SONG • 001 JetSet

AUDIO • 000 New Audio

Smart Chord setting (page 31)

M.D.B.
 Indicates the current M.D.B. (page 29).

Song Track Status

Indicates the track status of the current Song (pages 36 and 42).

REC 1 2 3 4 5 A

Highlighted when ready for recording.

Specified as Song recording target.

Contains data and is muted.

Contains no data.

Contains data and can be played back.

Basic Controls

Before operating the instrument, it may be helpful to familiarize yourself with the basic controls below that are used to select items and change values.

■ Dial

Rotate the dial clockwise to increase the value, or counterclockwise to decrease the value.

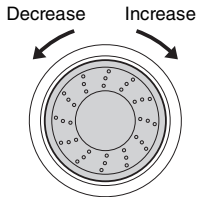

■ Number buttons

Use the Number buttons to directly enter a number or parameter value.

For numbers that start with one or two zeroes (such as “003”), the first zeroes can be omitted. However, completely entering [0]→[0]→[3] will display “003” quicker than pressing only [3].

Example: Selecting Voice 003

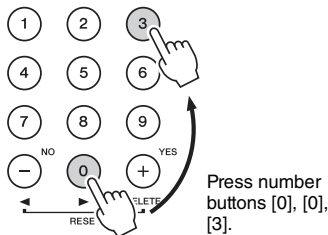

■ [-] and [+] buttons

Press the [+] button briefly to increase the value by 1, or press the [-] button briefly to decrease the value by 1. Press and hold either button to continuously increase or decrease the value in the corresponding direction. To restore the value to the default setting, press both buttons simultaneously.

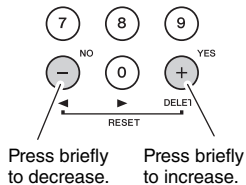

■ CATEGORY buttons

Use these buttons to jump to the first Voice, Style, or Song in the next or previous Category, and call up the next or previous Function sequentially.



Example: VOICE SELECT (MAIN) display

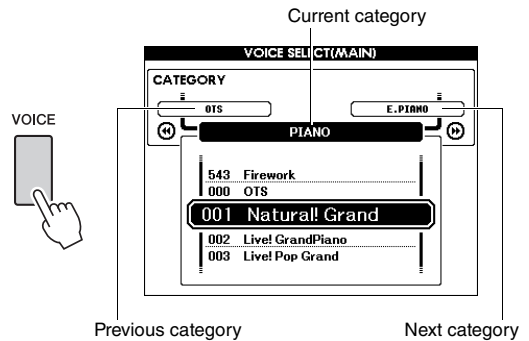

In most procedures described throughout this owner's manual the dial is recommended for selection simply because it is the easiest and most intuitive selection method. Please note however, that most items or values that can be selected using the dial can also be selected using the [+] and [-] buttons.

Try Playing a Variety of Instrument Voices

In addition to the wonderfully realistic piano sounds, you can select and play other musical instrument Voices, such as organ, guitar, bass, strings, sax, trumpet, drums and percussion, and even sound effects.

Selecting a Main Voice

This procedure selects the Main Voice for playing on the keyboard.

1 Press the [VOICE] button to call up the Main Voice selection display.

The current Voice number and name will be highlighted.

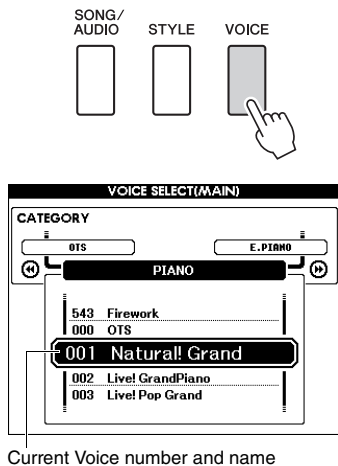

2 Use the dial to select the desired Voice.

The Voice List is provided on the front panel, or in the separate Data List.

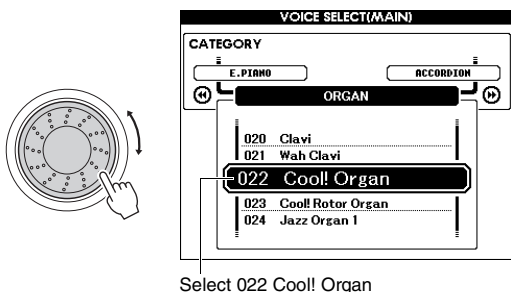

3 Play the keyboard.

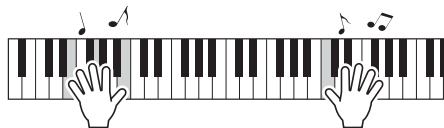

Preset Voice Types

001–147 163–543	Instrument Voices
148–162 (Drum Kit)	Various drum and percussion sounds are assigned to individual keys. Details on assigning instruments to keys are provided in the Drum Kit List of the separate Data List.
000	One Touch Setting (OTS) The One Touch Setting feature automatically selects the most suitable Voice for you when you select a Style or Song. Simply select Voice number “000” to activate this feature.

Playing the “Grand Piano”

When you want to reset various settings to default and simply play a Piano sound, press the [PORTABLE GRAND] button.



The Voice number is set to 001 “Natural! Grand Piano” and all the settings are turned off automatically, so only the Grand Piano Voice will play over the entire keyboard.

Layering Two Voices—Dual Voice

In addition to the Main Voice, you can layer a different Voice over the entire keyboard as a “Dual Voice.”

- 1 Press the [DUAL ON/OFF] button to turn Dual on.

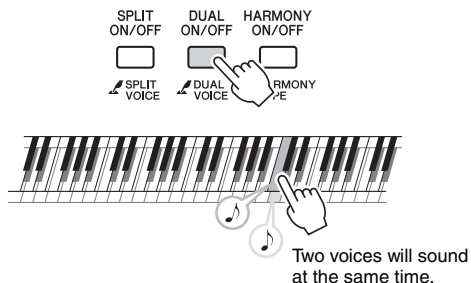

You can confirm whether the Dual function is on in the MAIN display (page 21).



Dual Voice number and name appear when Dual is on.

- 2 Press the [DUAL ON/OFF] button again to exit from Dual.

Although turning on Dual will select a Dual Voice suitable for the current Main Voice, you can easily select a different Dual Voice (page 57).

Playing a Split Voice in the Left Hand area

By dividing the keyboard into two separate areas, you can play one Voice with your right hand and a different Voice with your left.

- 1 Press the [SPLIT ON/OFF] button to turn on Split.

The keyboard is divided into the left hand and right hand areas.

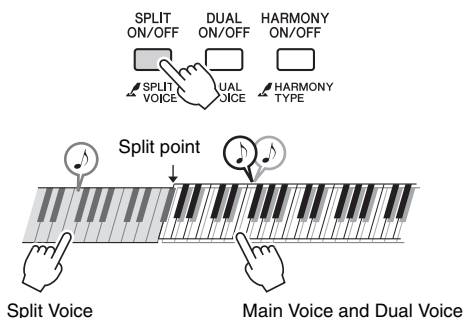

You can play a “Split Voice” on the left hand area of the keyboard while playing a Main Voice and Dual Voice on the right hand area of the keyboard. The highest key for the left hand area is referred to as the “Split Point” which can be changed from the default F#2 key. For details, refer to page 61.

You can confirm whether the Split function is on in the MAIN display (page 21).



Split Voice number and name appear when Split is on.

- 2 Press the [SPLIT ON/OFF] button again to exit from Split.

You can easily select a different Split Voice (page 57).

Using the Metronome

The instrument features a built-in metronome (a device that keeps an accurate tempo), convenient for practicing.

- 1 Press the [METRONOME ON/OFF] button to start the metronome.

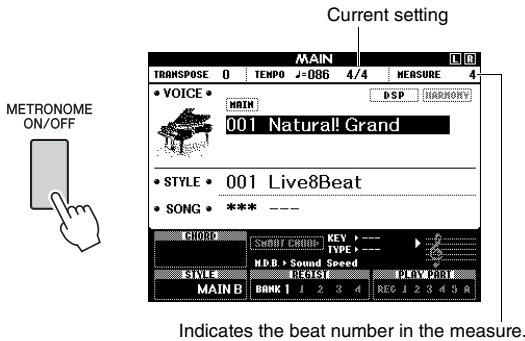

Indicates the beat number in the measure.

- 2 Press the [METRONOME ON/OFF] button again to stop the metronome.

Adjusting the Metronome Tempo

Press the [TEMPO/TAP] button to call up the Tempo value, then use the dial to adjust the Tempo value.

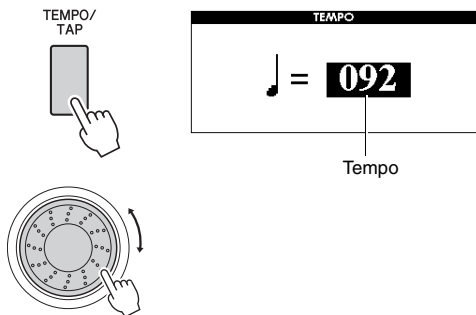

Press the [EXIT] button to return to the MAIN display.

Setting the Time Signature

Here, we'll set a time signature of 3/4 as an example.

- 1 Hold down the [METRONOME ON/OFF] button for longer than a second to call up "Time Signature - Numerator."

The time signature is shown on the display.

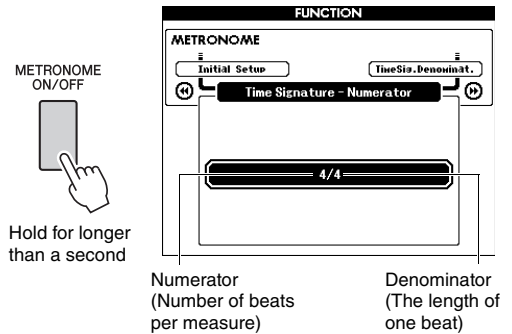

NOTE

- The metronome time signature will synchronize to a Style or Song that is selected, so these parameters cannot be changed while a Style or Song is playing.

- 2 Rotate the dial to select "3." A bell will sound on the first beat of each measure while the other beats will click.
- 3 Press the CATEGORY [▶▶] button to call up "Time Signature - Denominator."

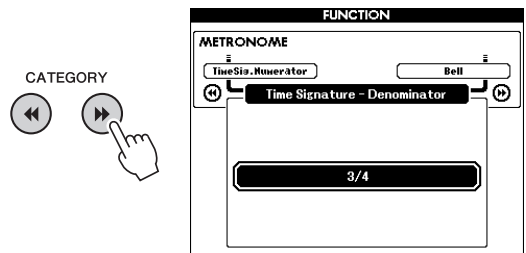

4 Rotate the dial to select “4.”

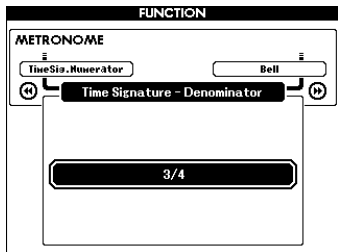

5 Confirm the setting by playing the Metronome.

Setting the Metronome Volume

1 Press the [FUNCTION] button to call up the FUNCTION display.

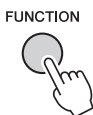

2 Press the CATEGORY [◀◀] or [▶▶] buttons repeatedly to select “Metronome Volume.”

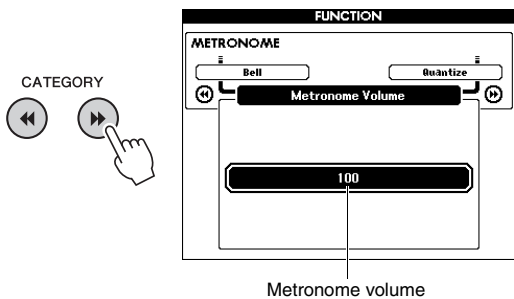

3 Rotate the dial to set the Metronome Volume.

Setting the Bell sound

This allows you to select whether the click sound has a bell accent, or plays only a click sound.

1 Press the [FUNCTION] button.

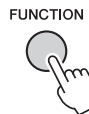

2 Use the CATEGORY [◀◀] or [▶▶] button repeatedly to select “Bell.”

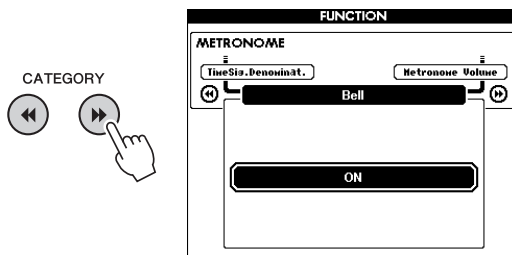

3 Rotate the dial to turn the bell sound on or off.

Adding Harmony

You can add harmony notes to the Main Voice.

- 1 Press the [HARMONY ON/OFF] button to turn Harmony on.

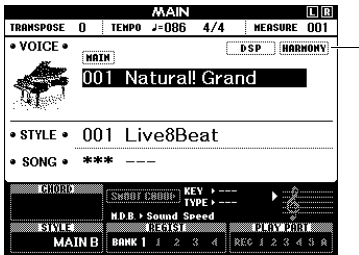
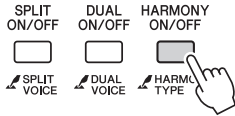

Appears when Harmony is turned on.

Although turning on the Harmony will select a Harmony Type suitable for the current Main Voice, you can select a different Harmony Type.

- 2 Hold down the [HARMONY ON/OFF] button for longer than a second until “Harmony Type” appears on the display.

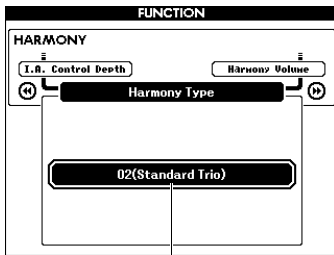
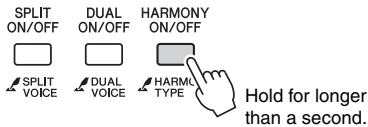

Current Harmony Type

- 3 Rotate the dial to select the desired Harmony Type.

For details, refer to the separate Data List. The effect and operation differs depending on the Harmony Type. Refer to the section below.

How to sound each Harmony Type

Harmony type 01 to 10, 13



Press the right-hand keys while playing chords in the auto accompaniment range of the keyboard when the Auto Accompaniment is on (page 28).

Harmony type 15 to 18 (Echo)



Play the keys.

Harmony type 19 to 22 (Tremolo)

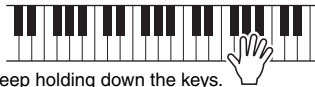

Keep holding down the keys.

Harmony type 23 to 26 (Trill)



Hold down two keys.

You can adjust the Harmony Volume in the Function Settings (page 68).

Playing Styles

The instrument features a variety of accompaniment and rhythmic backing patterns (called “Styles”) in a variety of different musical genres including pop, jazz, and many others. Each Style features Auto Accompaniment, letting you produce automatic accompaniment playback simply by playing “chords” with your left hand. This lets you automatically recreate the sound of a full band or orchestra — even if you’re playing by yourself.

1 Press the [STYLE] button to call up the STYLE selection display.

The current Style number and name is highlighted.

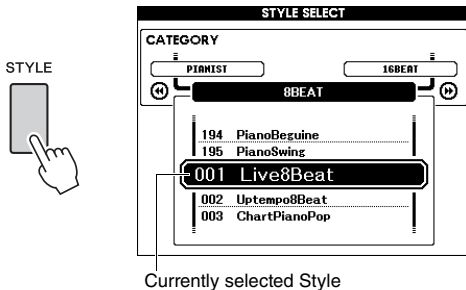

2 Use the dial to select the desired Style.

The Style List is provided on the front panel, or in the separate Data List.

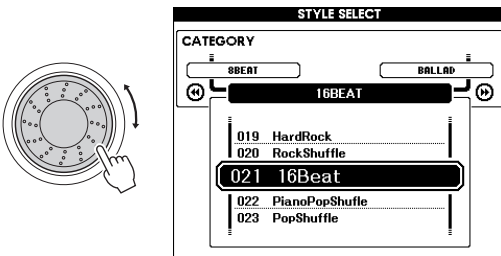

NOTE

- You can also play the Styles in the instrument's flash memory area transferred from a computer (refer to “Computer-related Operations”—page 9) or loaded from a USB flash memory (page 76), and Styles on a USB flash memory connected to the instrument. These styles are numbered from 196 upward.

Playing only the Rhythm Part

Pressing the [START/STOP] button starts playback of only the rhythm part. To stop playback, press the [START/STOP] button again.

Keep in mind that some Styles, such as “PIANIST” category Styles, have no rhythm part. These Styles produce no sound even if you press the [START/STOP] button. When you want to use any of these Styles, always execute step 3 and later so that all accompaniment parts will sound.

3 Press the [ACMP ON/OFF] button to turn on the Auto Accompaniment.

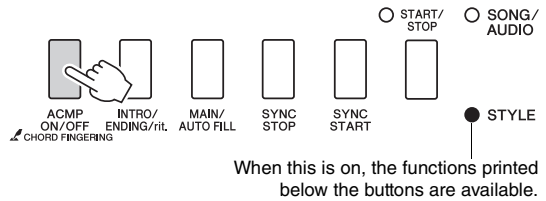

4 Press the [EXIT] button to return to the MAIN display, then confirm whether the Auto Accompaniment is on.

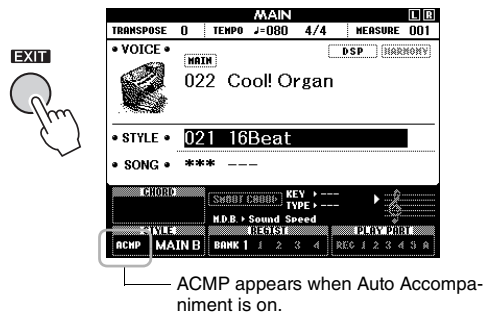

When the Auto Accompaniment is on, the keyboard area left to the Split Point (54: F#2) becomes the “Auto Accompaniment range” and is used only for specifying the chords.

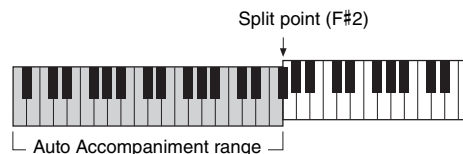

NOTE

- The Split Point can be specified from the FUNCTION display. For details, refer to page 61.

5 Press the [SYNC START] button to turn Synchro Start on.

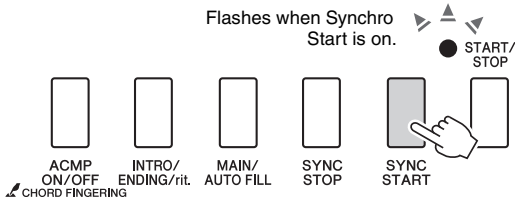

6 Play a chord in the Auto Accompaniment range to start Style playback.

Play a melody with your right hand and chords with your left.

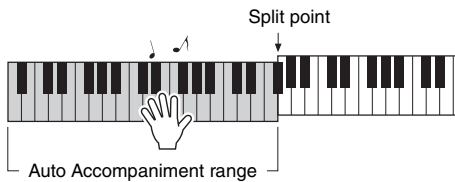

Chord indication

Chords being played in the Auto Accompaniment range will appear.

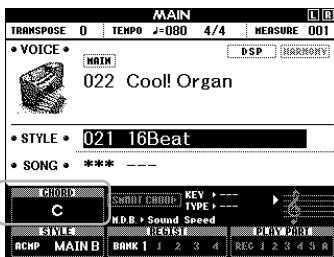

For information about chords, refer to “Chords” (page 30) or use the Chord Dictionary function (page 62).

You can adjust the volume of the Style playback. For details, see page 60.

7 Press the [START/STOP] button to stop playback.

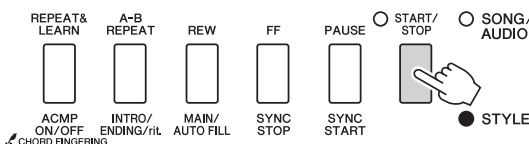

You can add intro, ending and rhythm variations to Style playback by using “Sections.” For details, refer to page 58.

Using the Music Database

If you have difficulty finding and selecting the desired Style and Voice, use this feature. From the Music Database, simply selecting your favorite music genre calls up the ideal settings.

1 Press the [MUSIC DATABASE] button to call up the Music Database selection display.

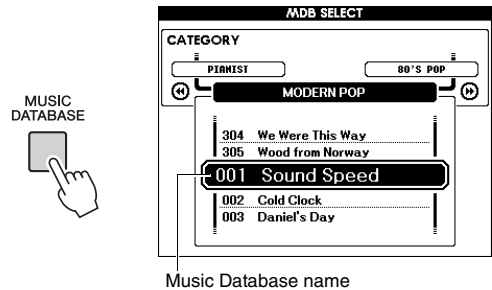

Both the Auto Accompaniment and Synchro Start are automatically turned on.

2 Use the dial to select the desired Music Database.

This operation calls up the panel settings such as Voice and Style that are registered to the selected Music Database. The Music Database List is provided in the separate Data List.

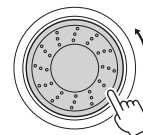

3 Play the keyboard as described in Steps 6 to 7 in this page.

Chords

For users who are unfamiliar with chords, this chart shows the notes of common chords. Since there are many useful chords and many different ways to use them musically, refer to commercially available chord books for further details.

★ indicates the root note.

Major	Minor	Seventh	Minor Seventh	Major Seventh
C 	Cm 	C7 	Cm7 	CM7
D 	Dm 	D7 	Dm7 	DM7
E 	Em 	E7 	Em7 	EM7
F 	Fm 	F7 	Fm7 	FM7
G 	Gm 	G7 	Gm7 	GM7
A 	Am 	A7 	Am7 	AM7
B 	Bm 	B7 	Bm7 	BM7

- A wide variety of chord types can be recognized as well as the above chord types.
- Depending on the chord type, inversions can be used as well as in "root" position.
- Some chord types may not be recognized if some notes are omitted.

Easy Chords

This method lets you easily play chords in the accompaniment range of the keyboard using only one, two, or three fingers.

For a root of "C"



To play a major chord
Press the root note (★) of the chord.



To play a minor chord
Press the root note together with the nearest black key to the left of it.



To play a seventh chord
Press the root note together with the nearest white key to the left of it.



To play a minor seventh chord
Press the root note together with the nearest white and black keys to the left of it (three keys altogether).

Changing the Chord Fingering type

There are three different Chord Fingering Types. For details, refer to page 61.

Using the Smart Chord feature

If you want to fully enjoy playing in various Styles but don't know how to play the appropriate chords, Smart Chord is very useful. This function lets you control Styles with just a single finger as long as you know the key of your playing music, even if you don't know any chord fingering such as major, minor, diminished and so on. Appropriate chords suited for the music genre will sound whenever you press a single note, as if you were playing the "right" chords.

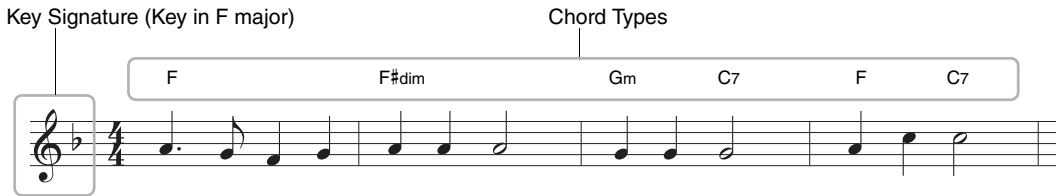

- 1 Select the Style which you want to play with, as described in steps 1–2 on page 28.
- 2 Press the [EXIT] button to return to the MAIN display.
- 3 Press the [SMART CHORD] button to turn on the Smart Chord function.



Indicates the current Smart Chord settings, KEY and TYPE when the Smart Chord is on.

NOTE

Smart Chord can be turned on after pressing the [STYLE] button.

- 4 Hold down the [SMART CHORD] button until the SMART CHORD setting display appears.

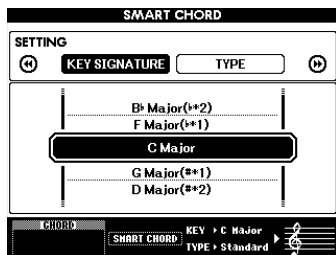

- 5 On the KEY SIGNATURE page, use the dial to select the Key Signature. Make sure to select the Key Signature which is same as that on your music score, or your desired key for playing. Check the Key Signature indication at the right bottom corner of the display.

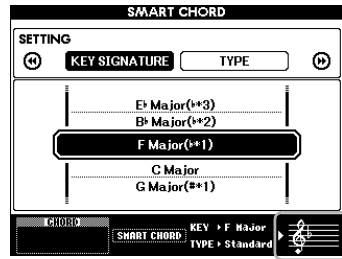

Indicates the selected Key Signature. Set this to the same as your music score.

Since the number of flats or sharps is shown to the right of Key Signature in the display, you can also find the desired Key Signature by counting the number of flats or sharps.

TYPE Page:

This page provides five Types of music genres which determine the specific chord assignment for each scale note in the Auto Accompaniment range. Although selecting a Style in step 1 will automatically set the optimum Type, you can select a different Type here for more appropriate results, if necessary. To do so, from the SMART CHORD display press the CATEGORY [▶▶] button to select the TYPE page then use the dial to select a Type.

The actual chord assignments are provided in the Smart Chord Chart in the separate Data List.

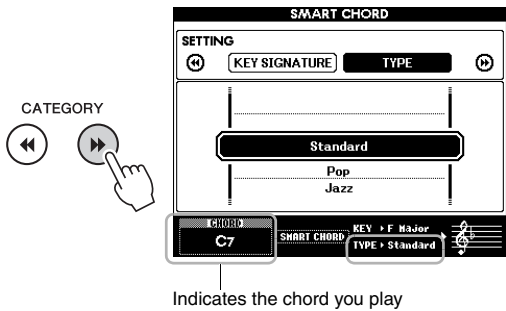

NOTE

- Each music type assumes only typical or conventional chord progression for the Style.
- The root of a chord shown at the bottom left of the display during Song recording may be different when the recorded Song is played back.

6 Press the [SYNC START] button to turn Synchro Start on.

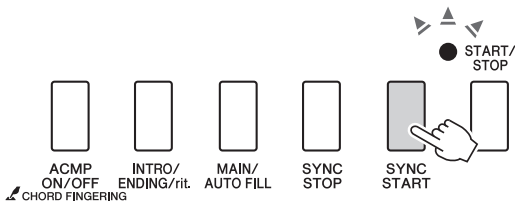

7 According to the music score or the chord progression of your performance, play only the root key with the left hand.

Pressing a key will start playback of the Style. You can try the chord progression F - F# - G - C - F - C in order referring to the score on page 31.

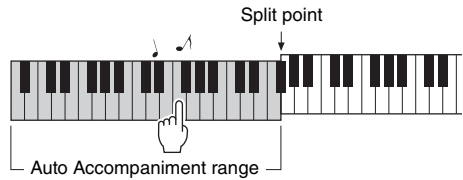

A sample score for the Smart Chord function is provided in the separate Data List.

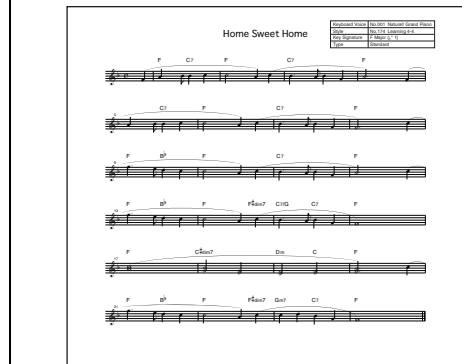

8 Press the [SMART CHORD] button to turn off the Smart Chord function.

Calling up Optimum Styles for Your Performance (Style Recommender)

This convenient function “recommends” optimum Styles for your performance, based on the rhythm you play for one or two measures.

1 Press the [STYLE RECOMMENDER] button to call up the STYLE RECOMMENDER display.

The keyboard is divided by the B0 key into two sections (Drum and Piano) as shown below.

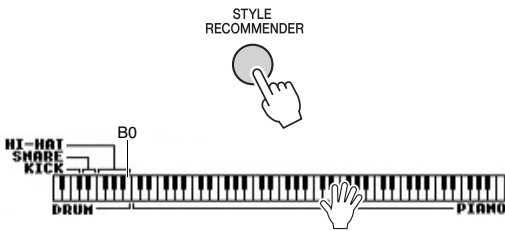

The Drum instruments (Kick, Snare and Hi-Hat) are assigned to the left-side section while the Piano sound is assigned to the right.

2 Search for the desired Style.

2-1 Press the [START/STOP] button to start the metronome.

A “WAITING” indication appears in the display. As necessary, use the [+]/[-] buttons to select the beat, and use the [TEMPO/TAP] button to adjust the tempo (page 60).

2-2 While “WAITING” is shown, play the rhythm you have in mind on the Drum or Piano section for one or two measures along with the metronome.

Below are two possible examples.

Example 1: Play the following rhythm in the Piano section of the keyboard.



Bossa Nova Styles or those of a similar feel may be listed on the display.

Example 2: Play the following rhythm in the Drum section of the keyboard.



8-beat Styles or those of a similar feel may be listed on the display.

The timing at which you play the keys is analyzed over several seconds, then playback of the most recommended Style starts. In addition, the candidates of the other recommended Styles are listed in the display.



NOTE

- Only the note-on timing is analyzed. Tempo, pitches and note length are ignored.
- The recommended Style plays back according to the last chord played in the PIANO section. The PIANO section detects chords using the Fingering Chord type “FullKeyboard” (page 61).

3 Listen to the highest recommended Style, while playing chords in the PIANO section (as shown in step 1).

You can try out other Styles listed on the display by using the dial. If you cannot find the desired Style in the list, press the [STYLE RECOMMENDER] button, then return to step 2-2.

4 When you’ve found a Style you’re satisfied with, press the [EXIT] button to exit from the Style Recommender display.

5 Play the keyboard along with the Style you just found.

Playing Songs and Audio Files

There are two kinds of data that can be recorded and played back on this instrument: Songs and Audio files. Not only can you play back a Song or Audio file and listen to it, but you can also play the keyboard along with Song or Audio file playback.

• Songs

The Songs are organized by category as listed below, allowing you to easily select from the desired category. The numbers 001–100 are Preset Songs, and a complete list is provided in the separate Data List. The numbers 101–105 are Songs you've recorded on this instrument, and numbers from 106 upward are MIDI files in SMF (Standard MIDI File) format in this instrument's flash memory and a USB flash memory connected to this instrument.

SONG

001-003	MAIN DEMO	• Gives you an idea of the advanced capabilities of this instrument.
004-011	VOICE DEMO	• Demonstrates many useful Voices of this instrument.
012-037	PIANO SOLO	• These are piano solo pieces.
038-064	PIANO ENSEMBLE	• These are piano ensemble pieces.
065-074	PIANO ACCOMPANIMENT	• When you need to practice backing (accompaniment) patterns, these songs are ideal for that purpose.
075-093	CLASSICAL MELODIES	• Includes famous classical music pieces.
094-100	TRADITIONAL MELODIES	• Includes traditional Songs from around the world.
101-105	USER SONG	• Songs you've recorded on this instrument (page 40).
106-	FLASH MEMORY / USB	• Songs (MIDI files) in the instrument's flash memory area transferred from a computer (refer to "Computer-related Operations"—page 9) or loaded from a USB flash memory (page 76), and Songs (MIDI files) on a USB flash memory connected to the instrument.

NOTE

- Score data for the Preset Songs (exceptions are the Over View Demo Song and Songs 1–11) are provided in the Songbook, which is available as a free download from the website (page 9).

• Audio files

Commercially available Audio files in WAV format (file extension: .wav with 44.1 kHz sample rate, 16 bit resolution, stereo) and your own recorded Audio files on a USB flash memory can be played back (page 45).

Availability of functions differs between Songs and Audio files. In this manual, the following icons indicate whether or not the explanation applies to Songs or Audio files individually.

Example: **SONG** **AUDIO** ... Indicates explanation applies only to Songs.

Listening to the Overview Demo

This is a special demo for sound demonstrations and features. Press the [DEMO/BGM] button to start playback of the Overview Demo continuously, calling up the various displays in sequence.

DEMO/BGM



To stop playback, press the [DEMO/BGM] button or [START/STOP] button.

Please note that any Song-related functions with “**SONG**” cannot be applied to Overview Demo.

NOTE

- With the default setting, only one Demo is played back and repeated when the [DEMO/BGM] button is pressed. This setting can be changed so that all Preset Songs are played, or all Songs and Audio files on a USB flash memory are played. Five playback group settings are provided. Simply select the one that suits your needs (page 63).

Playing Back a Song or Audio File

SONG

AUDIO

Before using a USB flash memory, be sure to read “Connecting a USB Flash Memory” on page 71.

- If you want to play back a Song or Audio file on a USB flash memory, connect a USB flash memory to the USB TO DEVICE terminal.

Audio files must be on a USB flash memory.

Important

- In order to play a file on a USB flash memory, the file must be stored either in the USB flash memory’s root directory or a first-level/ second-level folder in the root directory. Files stored in third-level-folders created inside a second-level folder cannot be selected and played by this instrument.

USB flash memory (Root)

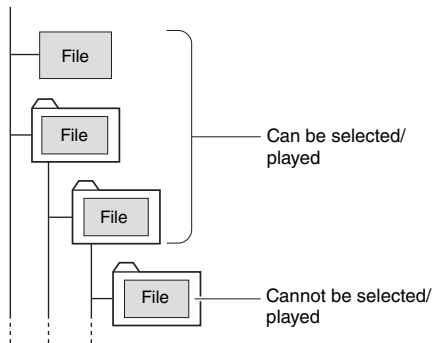

- Press the [SONG/AUDIO] button once or twice to call up the SONG SELECT display for Song selecting, or AUDIO SELECT display for Audio selecting.

The available Songs or Audio files are listed on the display.

If a USB flash memory is connected, pressing the [SONG/AUDIO] button repeatedly toggles between two displays: SONG SELECT and AUDIO SELECT. If a USB flash memory is not connected, this operation calls up only SONG SELECT display.

SONG SELECT display

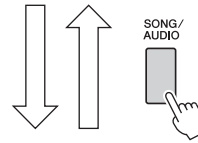
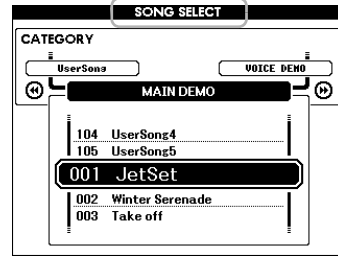

AUDIO SELECT display

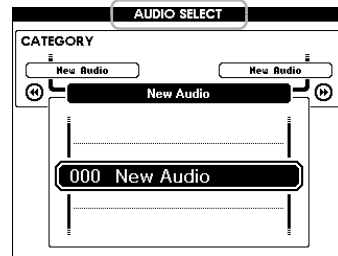

- Use the dial to select the desired Song or Audio file.

When selecting Songs, refer to the list on page 34.

- Press the [START/STOP] button to start playback.

To stop playback, press the [START/STOP] button again.

When this is on, the functions printed above the buttons are available.

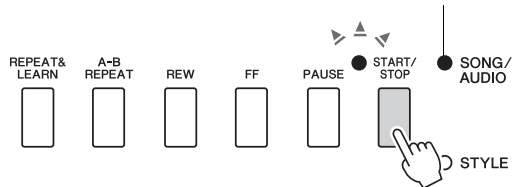

You can adjust the Song volume (page 64) and Audio volume (page 64).

Adjusting the Tempo of a Song

Same procedure as with Style tempo. See page 60.

NOTE

- The tempo of audio playback cannot be changed.

Fast Forward, Rewind, and Pause

SONG

AUDIO

This instrument lets you fast forward [FF], rewind [REW] and pause [PAUSE] playback of the Song or Audio file.

When this is on, the functions printed above the buttons are available.

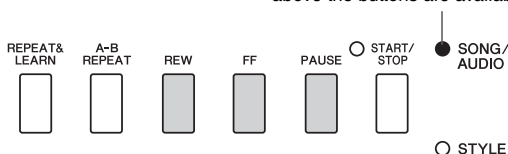

Pressing the [REW] or [FF] button once moves one measure backward/forward for Songs, or one second for Audio files. Holding one of them scrolls backward/forward continuously. Press the [PAUSE] button to pause playback, and press again to start from that point.

A-B Repeat

SONG

AUDIO

You can specify a desired section of a Song and repeatedly play back that section by setting the A point (start point) and B point (end point).



- 1 Start playback of the Song (page 35).
- 2 When playback reaches to the point you want to specify as the start point, press the [A-B REPEAT] button to set the A point.

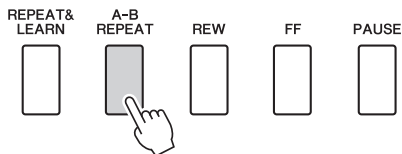

- 3 When playback reaches to the point you want to specify as the end point, press the [A-B REPEAT] button again to set the B point.

The specified A-B section of the Song will now play repeatedly.

- 4 To cancel repeat playback, press the [A-B REPEAT] button.

To stop playback, press the [START/STOP] button.

NOTE

- If you want to set the start point "A" at the top of the Song, press the [A-B REPEAT] button before starting playback.

Turning Each Track On/Off

SONG

AUDIO

Each "track" of a Song plays a different part—melody, percussion, accompaniment, etc. Each of the tracks can be muted so that you can play the muted part yourself. Pressing the desired Track button repeatedly will toggle the on/off status.

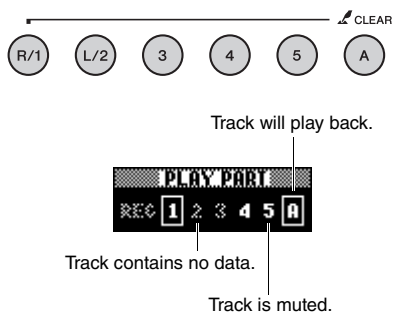

NOTE

- Up to two Track buttons can be pressed simultaneously for turning on or off.

Displaying the Song Score

SONG

AUDIO

You can view the music notation (score) of the selected Song.

- 1 Select a Song (steps 1–3 on page 35).
- 2 Press the [SCORE] button to call up the Score display.

Pressing this button each time alternates the displayed notation style between single-staff and double-staff.

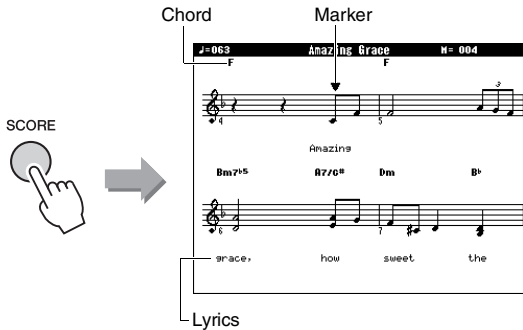

Both chords and lyrics will be shown in single-staff score display of a Song that includes chords and lyric data.

- 3 Press the [START/STOP] button to start Song playback.

The marker moves to indicate the current position.

If the Song parts are muted at this point you will be able to hear only the sound of your own performance so that you can play the Song yourself while reading the score. Refer to page 36 for more information on Song muting.

NOTE

- When there are many lyrics, they may be displayed in two rows a measure, and/or some lyrics or chords may be abbreviated.
- Small notes that are hard to read may be easier to read after you use the Quantize function (page 69).
- No chords or lyrics are shown on the double-staff display.

- 4 Press the [EXIT] button to return to the MAIN display.

Displaying the Lyrics

SONG

AUDIO

When the selected Song contains lyric data, you can view it on the instrument's display during playback.

- 1 Select Song 38 (steps 1–3 on page 35), which is the only internal Song that provides lyric display.
- 2 Press the [LYRICS] button to call up the Lyrics display.

The title, lyricist, and composer of the Song will appear on the display.

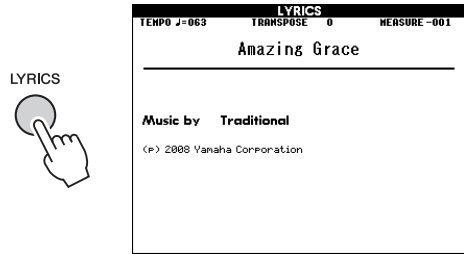

- 3 Press the [START/STOP] button.

The Song will play back while the lyrics and chords are shown on the display. The lyrics will be highlighted to show the current location in the Song.

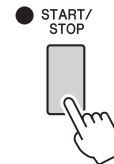

NOTE

- Commercially available Song files, including XF format files (page 8), are compatible with the Lyrics display features as long as they are standard MIDI file format files containing lyric data. Lyrics display may not be possible with some files.

- 4 Press the [EXIT] button to return to the MAIN display.

Using the Song Lesson Feature

You can use the selected Song for a left-hand, right-hand, or both-hands lesson. Try practicing with these three Song Lesson types.

Three Types of Song Lesson

Lesson 1—Waiting

In this Lesson, try playing the correct notes shown on the display. The Song pauses until you play the right note.

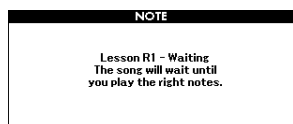

Lesson 2—Your Tempo

In this Lesson, try playing the correct notes shown on the display with the correct timing. The Song playback tempo will change to match the speed at which you are playing at.

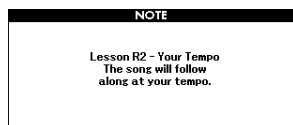

Lesson 3—Minus One

Here's where you can perfect your technique. The Song will play at the normal tempo, minus the part you have chosen to play. Play along while listening to the Song.

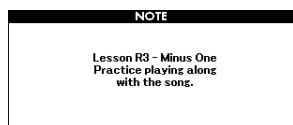

Practicing with Song Lesson

1 Select the desired Song for your lesson (page 35).

NOTE

- Audio files cannot be used with the Lesson features.

NOTE

- The Song Lesson features can be applied also to User Songs and Songs (SMF format 0 and 1) on a USB flash memory or transferred/loaded to the instrument (pages 74 and 76).

2 Press the [EXIT] button to return to the MAIN display.

3 Select the part you want to practice.

Press the [R/1] button for a right-hand lesson, [L/2] button for a left-hand lesson, or press both the [R/1] and [L/2] buttons simultaneously for a both-hands lesson. The currently selected part is shown in the upper right corner of the display.

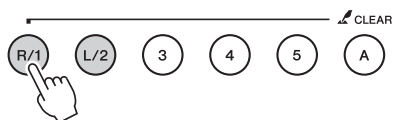

- R** : Right-hand lesson
- L** : Left-hand lesson
- L R** : Both-hands lesson



4 Press the desired LESSON START button, [WAITING], [YOUR TEMPO] or [MINUS ONE] to start playback of the Song Lesson.

Play the notes shown in the on-screen score. The score marker and keyboard marker in the display will indicate the notes to play.

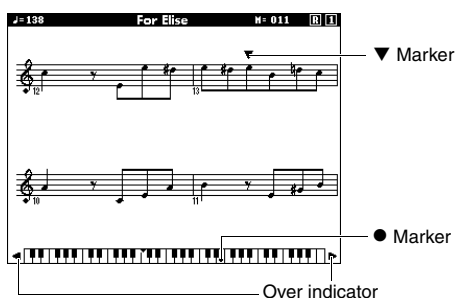

NOTE

- The notes in the on-screen score may be shown an octave higher or lower (or more) depending on the Voice used in the Song.
- Since the display has restrictions, the on-screen score may appear somewhat different from commercially available scores. When using the Lesson function, also make sure to refer to the notes shown in the on-screen keyboard at the bottom of the display. You can adjust the score appearance on the Lesson display by changing the Quantize parameter in the Score category in the Function List (page 69).

Shifting the on-screen keyboard left or right.

If the Over indicator appears, the hidden () areas of the keyboard can be brought into view by pressing the [+] or [-] button. Notes that actually fall outside the keyboard's range cannot be used in the lesson.

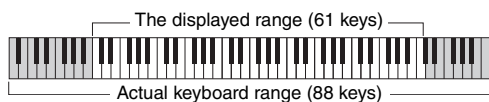

To stop Lesson playback, press the [START/STOP] button. Even during playback, you can change the Lesson number by pressing the [WAITING], [YOUR TEMPO] or [MINUS ONE] button.

5 When Lesson playback reaches the end, check your evaluation Grade on the display.

Your performance will be evaluated in four levels: OK, Good, Very Good, or Excellent. After the evaluation display has appeared, the lesson will start again from the beginning.



NOTE

- The evaluation feature can be turned off via the FUNCTION "Grade" item (page 69).

Making Practice Perfect—Repeat & Learn

If you want to practice a specific section in which you made a mistake or you have difficulty with use the Repeat & Learn function.

Press the [REPEAT & LEARN] button during Lesson playback.

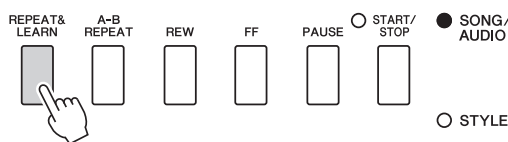

The Song location will move back four measures, a one-measure count will play, then Song playback will start again. Playback of the four measures will repeat with a one-measure count-in.

To exit from this status, press this button again.

NOTE

- You can change the amount of measures the Repeat & Learn function jumps back by pressing a number button [1] to [9] during repeat playback.

Recording Your Performance

This instrument allows you to record your performance in the following two methods.

• Song recording (MIDI recording)

With this method, recorded performances are saved to the instrument as a User Song, in SMF (format 0) MIDI file. If you want to re-record a specific section or edit parameters such as Voice, use this method. Also if you want to record your performance to each track one by one, execute “Recording to a Specified Track” of the Song recording method. Since a User Song can be converted to an Audio file after recording (page 75), you may want to use Song recording (with individual track recording) to first create a complex arrangement you would not otherwise be able to play live, then convert it to an Audio file. Up to approximately 30,000 notes can be recorded for one User Song if you record only to the tracks [R/1]–[5].

• Audio recording (page 45)

With this method, recorded performances are saved to a USB flash memory as an Audio file. Recording is done without designating the recorded part. Since it is saved in stereo WAV format of normal CD quality resolution (44.1kHz/16bit) by default, it can be transmitted to and played on portable music players by using a computer. This instrument allows you to record up to 80 minutes per single recording.

Song Recording

SONG

AUDIO

You can record up to five of your performances and save them as User Song 101 through 105. This operation is for recording a new Song from scratch. If you want to re-record a specific track, execute “Recording to a Specified Track (Song Recording)” on page 42.

NOTE

- Split Voice, Metronome, and the AUX IN sound cannot be recorded.

1 Press the [SONG/AUDIO] button once or twice to call up the SONG SELECT display for Song recording.

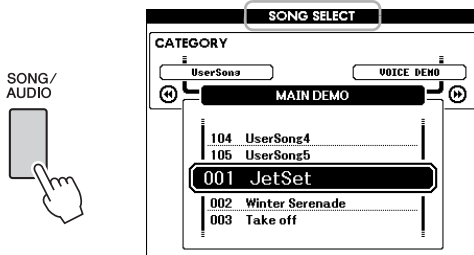

If a USB flash memory is connected, pressing the [SONG/AUDIO] button repeatedly toggles between two displays: SONG SELECT and AUDIO SELECT. If a USB flash memory is not connected, this operation calls up only SONG SELECT display.

You can select the desired User Song with the dial.

2 If you want to record with a Style, press the [STYLE] button then the [ACMP ON/OFF] button to turn ACMP on.

Once you have set the ACMP to ON, don't call up the SONG SELECT or AUDIO SELECT display because doing so will set the ACMP to OFF.

3 Press the [REC] button to enable recording.

If a User Song was not selected beforehand, this operation selects the lowest-numbered unrecorded User Song (from 101–105) as the Recording target.



Track 1 (and A) is automatically selected for recording.

To cancel recording, press the [REC] button or [EXIT] button.

NOTICE

- If all User Songs (Song numbers 101–105) contain recorded data, Song 101 will automatically be selected. In this case, you will record over and erase any previous data of this Song.

NOTE

- You can use the Metronome while recording although the metronome sound will not be recorded. After pressing the [REC] button, set the Time Signature and start Metronome before going on to step 4.

4 Play the keyboard to start recording.

You can also start recording by pressing the [START/STOP] button.



The current measure will be shown on the display during recording.



Current measure

5 After you finish performance, press the [START/STOP] button or [REC] button to stop recording.

When recording is stopped, a message asking if you want to save the Song will appear.

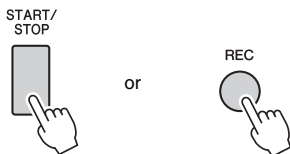
**NOTICE**

- The recorded Song will be lost if you turn the power off without executing the save operation.

6 Press the [+] (YES) button to save the Song.

The Song will be stored as a MIDI file to Song number 101–105. To cancel saving, press the [-] (NO) button at the prompt.

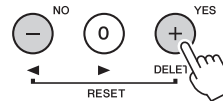
**NOTICE**

- Never attempt to turn the power off when a “Now Writing...” message is shown in the display. Doing so can damage the flash memory and result in a loss of data.

7 To hear the newly recorded performance, press the [START/STOP] button.**NOTE**

- If you press the [-] (NO) button once in response to the confirmation message, you have the option of saving the Song later until the power is turned off or another Song is selected. To do this hold down the [REC] button until the save confirmation message appears, then press the [+] (YES) button.

Data that cannot be recorded to Songs

Aux in sound, Metronome sound, Damper Resonance effect, Split Voice, Damper Resonance ON/OFF, Master EQ Type, Output Gain, I.A.Control, I.A.Control Depth, MDB, Song Volume, Transpose, Tuning, Split Point

Data that cannot be changed during the Song recording

Style Number, ACMP ON/OFF, Smart Chord setting, Style Volume, Chord Fingering, Touch Response, Time Signature

Recording to a Specified Track

SONG

AUDIO

With Song Recording, you can create a Song consisting of six tracks (1–5 and A) by recording your performance to each track one by one. In recording a piano piece, for example, you can record the right-hand part to Track 1 then record the left-hand part to Track 2, allowing you create a complete piece which may be difficult to play live with both hands together. To record a performance with Style playback, for example, record the Style playback to Track A, then record melodies to Track 1 while listening to the already recorded Style playback. In this way, you can create an entire Song which would otherwise be difficult, or even impossible, to play live.

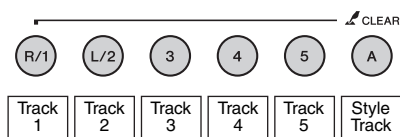

Tracks [1]–[5] For recording your keyboard performances, such as a piano piece.

Track [A] For recording Style playback.

NOTE

- Split Voice, Metronome, AUX IN sound cannot be recorded.

Before recording, make the necessary settings such as Voice/Style selection.

1 If you want to re-record an existing User Song, select the desired User Song. (Execute step 1 on page 40 then select the User Song from 101–105 using the dial.)

If you want to record from scratch, select the unrecorded User Song.

2 To specify the target track, while holding down the [REC] button, press one track button from [1]–[5] or [A].

To cancel recording to a specified track, press that track button again.

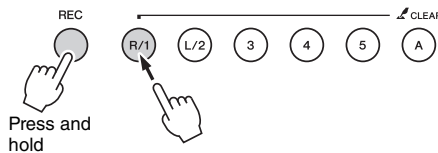

To record your keyboard performance, specify from [1] to [5]. (To record the Dual Voice specify from [1] to [3].)

To record the Style playback, specify [A]. (ACMP is automatically turned on.)

The selected track will be highlighted in the display.

(When Track 1 is specified)



Track 1 will be highlighted

(When Track A is specified)



Track A will be highlighted

When Track A is specified, you can specify one more track from [1]–[5] by repeating this step, and vice versa.

To cancel recording, press the [REC] button or [EXIT] button.

NOTICE

- If you record to a track that contains previously recorded data, the previous data will be overwritten and lost.

NOTE

- If Auto Accompaniment is on and Track [A] has not yet been recorded, Track [A] will automatically be selected for recording when one of Tracks ([1]–[5]) is selected. If you only want to record to Track [1]–[5], be sure to turn Track [A] off.
- If the User Song selected in step 1 already contains recorded Style data, the same Style number is automatically set. If you want to select another Style, press the [STYLE] button then use the dial to select the desired Style after specifying the [A] track.

NOTE

- You can use the Metronome while recording although the metronome sound will not be recorded. After pressing the [REC] button, set the Time Signature and start Metronome before going on to step 3.

3 Play the keyboard to start Recording.



4 After you finish the performance, press the [START/STOP] button or [REC] button to stop recording.

When recording is stopped, a message asking if you want to save the Song appears.

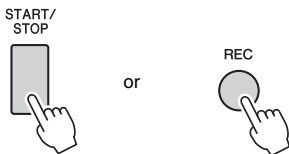

NOTICE

- The recorded performance will be lost if you turn the power off without executing the Save operation.

5 Press the [+] (YES) button to save the Song.

The Song will be stored as a MIDI file to Song number 101–105. To cancel saving, press the [-] (NO) button at the prompt.

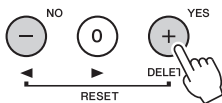

The recorded track numbers in the display will be shown in a box border.



NOTICE

- Never attempt to turn the power off when a “Now Writing...” message is shown in the display. Doing so can damage the flash memory and result in a loss of data.

6 To hear the newly recorded performance, press the [START/STOP] button.

7 Record your performance to another track by repeating steps 2–6.

In step 2, select a track which has no recorded data. Play the keyboard while listening to the already recorded data.

You can record to each track [1]–[5] using different Voices. Before specifying the target track, press the [VOICE] button and select the desired Voice, then press the [EXIT] button.

NOTE

- When recording another track, you can turn already recorded tracks on or off using the track buttons.

See page 41 for information on data that cannot be recorded to the Songs or cannot be changed during Song recording.

Clearing a User Song

SONG

AUDIO

You can clear all tracks of a User Song.

- 1 Press the [SONG/AUDIO] button, and then select the User Song (101 to 105) to be cleared.
- 2 While holding down the track [A] button, press the track [1] button for longer than a second.

A confirmation message will appear on the display.

To cancel this operation, press the [-] (NO) button.

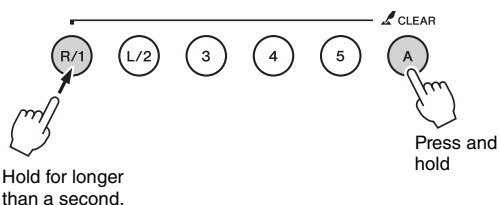

- 3 Press the [+] (YES) button to clear the Song.

A clear-in-progress message will appear briefly on the display.

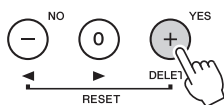

Clearing a Specified Track from a User Song

SONG

AUDIO

This lets you clear individual tracks from a User Song.

- 1 Press the [SONG/AUDIO] button, and then select the desired User Song (101 to 105).
- 2 From [1] to [5] and [A], press the Track button to be cleared for longer than a second.

A confirmation message will appear on the display.

To cancel this operation, press the [-] (NO) button.

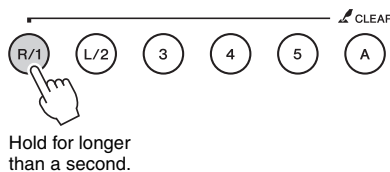

- 3 Press the [+] (YES) button to clear the track.

A clear-in-progress message will appear briefly on the display.

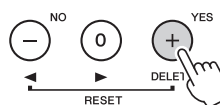

Audio Recording

SONG

AUDIO

Before recording, make the necessary settings such as Voice/Style selection and the AUX IN connection (if you want to record with the input sound via AUX IN jack). All the sound produced via this instrument other than Metronome can be recorded.

NOTICE

- Don't use the file name “_DGX-650_TMP.wav” in the USB flash memory because the file with the name will be overwritten and erased by newly recording Audio data.

1 Connect the USB flash memory to the USB TO DEVICE terminal.

Before using a USB flash memory, be sure to read “Connecting USB device” on page 70.

2 Press the [SONG/AUDIO] button once or twice to call up the AUDIO SELECT display for Audio recording.

If a User Audio file was not selected beforehand, this operation selects a new Audio file as recording target.

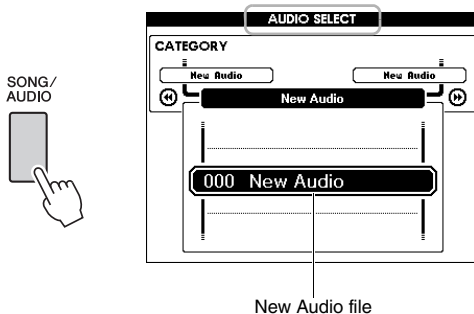

3 As necessary, select the Audio file for recording target.

If multiple Audio files are in the USB flash memory and the wrong file is selected by mistake, you can select a different file by using the dial. If you want to create a new Audio file, select “000 New Audio.”

NOTICE

- If you record to Audio file that contains previously recorded data the previous data will be overwritten and lost.

4 Press the [REC] button to be ready for recording.

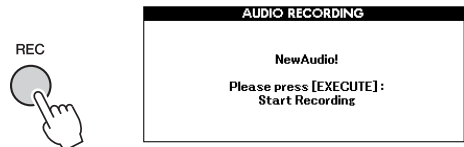

If you want to cancel recording, press the [REC] button again or [EXIT] button.

5 Press the [EXECUTE] button to start recording, then play the keyboard.

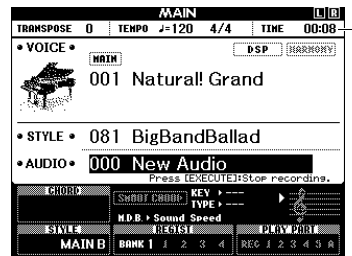
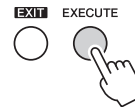

The elapsed recording time is shown in the MAIN display while recording.

NOTICE

- Never attempt to disconnect the USB flash memory or turn the power off during recording. Doing so may corrupt the USB flash memory data or the recording data.

6 After you finish the performance, press the [EXECUTE] button or [REC] button to stop recording.

The Audio file will automatically be saved as “UserAudioxxx” (xxx is 001–100) in a folder labeled “USER FILES” which will automatically be created on the USB flash memory. To delete the User Audio files 001–100, perform “USB Delete” described on page 77.

7 To hear the recorded performance, press the [START/STOP] button.

Memorizing Your Favorite Panel Settings

This instrument has a Registration Memory feature that lets you memorize your favorite settings for easy recall whenever they're needed. Up to 32 complete setups can be saved (eight banks of four setups each).

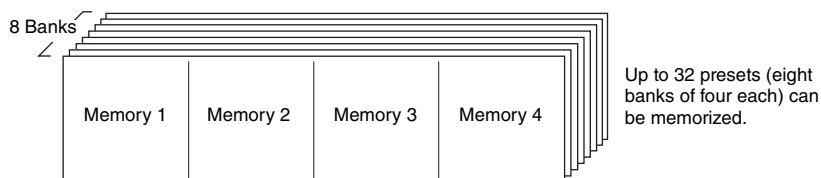

Memorizing Panel Settings to the Registration Memory

- 1 Make the desired settings such as those for Voice and Style.
- 2 Press and release the [BANK] button to call up a Bank number on the display.

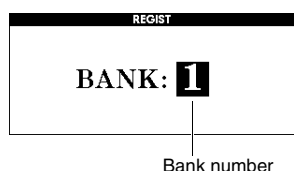
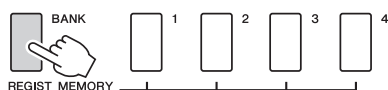

- 3 Use the dial to select a Bank number.

NOTE

- Data cannot be saved to the Registration Memory during Song playback.

- 4 While holding down the [BANK] button, press one of the REGIST MEMORY [1] to [4] buttons to memorize the current panel settings.

You can check the Registration Memory status in the MAIN display; Memory numbers that contain data light up, and a border appears around the selected one.

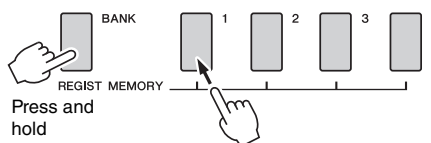

NOTICE

- If you select a Registration Memory number that already contains data, the previous data is deleted and overwritten by the new data.
- Do not turn off the power while memorizing settings to the Registration Memory, otherwise the data may be damaged or lost.

Recalling Panel Settings from the Registration Memory

- 1 Press and release the [BANK] button to call up a Bank number on the display.

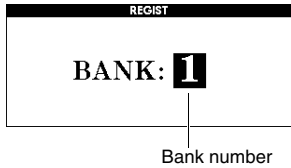
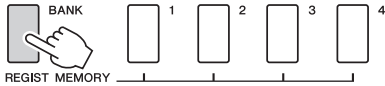

- 2 Use the dial to select a Bank number.
- 3 Press one of the REGIST MEMORY [1] to [4] buttons to call up the panel settings you memorized.

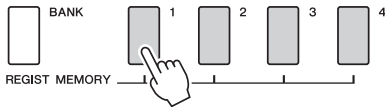

You can check the Registration Memory status in the MAIN display (page 21).

Settings that are Saved to the Registration Memory

Style settings*

Style number, Auto Accompaniment on/off, Split Point, Style settings (Main A/B), Style Volume, Tempo, Chord Fingering, Smart Chord on/off, Smart Chord Setting

Voice settings

Main Voice setting (Voice number and all settings of the related Functions)

Dual Voice settings (Dual on/off, Voice number and all settings of the related Functions)

Split Voice settings (Split on/off, Voice number and all settings of the related Functions)

Effect settings

Reverb Type, Chorus Type, Panel Sustain on/off, DSP on/off, DSP Type

Harmony settings

Harmony on/off and all settings of the related Functions

Other settings

Transpose, Pitch Bend Range

* Style settings are not available for Registration Memory when using the Song/Audio features.

Playing Audio Files via an External Audio Player

You can output the sound of an external audio device, such as a portable music player, through the built-in speakers of this instrument by connecting it via a cable. This lets you play the keyboard along with playback of your music player.

⚠ CAUTION

- Before connecting, turn off the power of both this instrument and the external audio device. Also, before turning the power on or off, make sure to set all volume levels to minimum (0). Otherwise, damage to the devices, electrical shock, or even permanent hearing loss may occur.

1 Turn off the power for both the external audio device and this instrument.

2 Connect the audio device to the instrument's AUX IN jack.

Use a cable which has a stereo-mini plug at one side for connecting to this instrument and a plug matching the output jack of the external audio device at the other side.

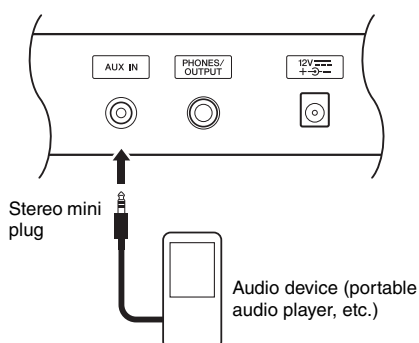

NOTICE

- After connecting, first turn on the power to the external audio device then to this instrument. Reverse this order when you turn the power off.

3 Turn on the external audio device, then this instrument.

4 Play back the connected external audio device.

The sound of the audio device is output through the speakers of this instrument.

5 Adjust the volume balance between the audio device and this instrument.

In general, the volume should be adjusted on the connected audio device.

NOTE

- You can adjust the volume of the sound input via the AUX IN jack from the external audio device. To do this, Press the [FUNCTION] button then use the CATEGORY buttons to select "AUX IN LEVEL," then adjust the value by using the dial.

6 Play the keyboard along with the sound of the audio device.

7 After finishing the performance, stop playback of the audio device.

8 Make sure to set all volume levels to minimum (0), then turn the power off to the instrument then to the audio device.

Backup Parameters and Initialization

Backup Parameters

The following data will be maintained even if the power is turned off and can be transferred then saved to a computer via Musicsoft Downloader as a single Backup file. For instructions, refer to “Computer-related Operations” (page 9).

Backup Data

- Registration Memory data (page 46)
- Function Settings (page 66):
 - Tuning, Split Point, Touch Sensitivity, Style Volume, Song Volume, Metronome Volume, Grade, Demo Group, Demo Play mode, Demo Cancel, Panel Sustain, Master EQ type, Chord Fingering, Auto Power Off setting, Damper Resonance ON/OFF, Output Gain, I.A. Control ON/OFF, I.A. Control Depth, Audio Volume, Aux IN Level

In addition to the Backup data above, all the User Songs and all the Song and Style files transferred from a computer or loaded from a USB flash memory will be maintained even if you turn off the power.

To initialize Backup data, execute “Clearing Backup data.”

To initialize data (excluding Backup data) transferred from a computer or loaded from a USB flash memory, execute “Clearing files in flash memory area.”

Initialization

This function erases the Backup data described above and Song/Style data, then restores all the default factory settings. As required, execute one of the following two procedures.

Clearing Backup data

This operation initializes the backup data. While holding down the highest white key on the keyboard, press the [⏻] (Standby/On) switch to turn the power on. Make sure to hold down the key until the message appears at the top left of the display.

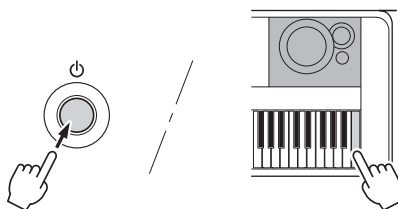

Clearing files in flash memory area

This operation deletes all User Songs and all the Songs and Styles that have been transferred from a computer or loaded from a USB flash memory. While simultaneously holding the highest white key and the three highest black keys, press the [⏻] (Standby/On) switch to turn the power on. Make sure to hold down the keys until the message appears at the top left of the display.

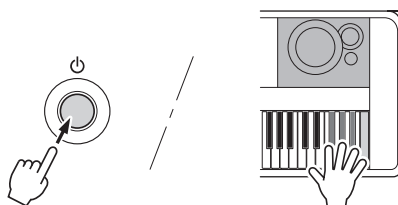

NOTICE

- *Keep in mind that this operation also deletes the data you have purchased. Be sure to save the important data to a computer via Musicsoft Downloader (MSD) software. For details, refer to “Computer-related Operations” (page 9).*

Handy Performance Features

Selecting a Reverb Type

The Reverb effect lets you play with a rich concert hall type ambience. Although selecting a Style or Song will call up the optimum Reverb type for the entire sound, you can select a different Reverb type manually.

- 1 Press the [FUNCTION] button.

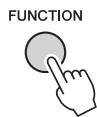

- 2 Use the CATEGORY [◀◀] and [▶▶] buttons to call up “Reverb Type.”

The current Reverb type is shown below.

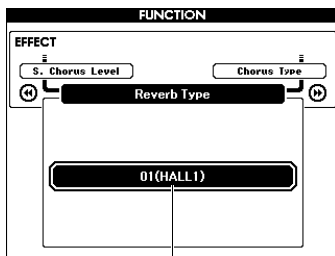

Current Reverb type

NOTE

- Some Songs and Styles use Reverb Types which cannot be selected via panel operations. If such a Song or Style is played back, “- -” is shown on the display. In such a case, you can select Reverb type 01 using the [+] or [-] button.

- 3 Rotate the dial to select a Reverb type.

Play the keyboard to check the sound. For information about the available Reverb types, refer to the Effect Type List in the separate Data List.

Adjusting the Reverb Level

You can adjust the Reverb level applied to the Main, Dual, and Split Voices individually via the same operations above. Regarding the item in Step 2, refer to the Function List on page 67.

Selecting a Chorus Type

The Chorus effect creates a thick sound that is similar to many of the same Voices being played in unison. Although selecting a Style or Song will call up the optimum Chorus type for the entire sound, you can select a different Chorus type manually.

- 1 Press the [FUNCTION] button.

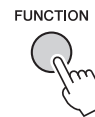

- 2 Use the CATEGORY [◀◀] and [▶▶] buttons to call up “Chorus Type.”

The current Chorus type is shown.

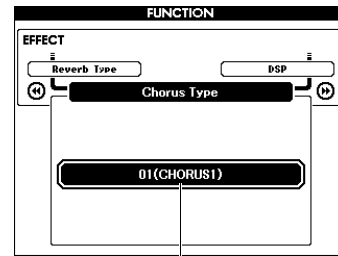

Current Chorus type

NOTE

- Some Songs and Styles use Chorus Types which cannot be selected via panel operations. If such a Song or Style is played back, “- -” is shown on the display. In such a case, you can select Chorus type 01 using the [+] or [-] button.

- 3 Rotate the dial to select a Chorus type.

Play the keyboard to check the sound. For information about the available Chorus types, refer to the Effect Type List in the separate Data List.

Adjusting the Chorus Level

You can adjust the Chorus level applied to the Main, Dual, and Split Voices individually via the same operations above. Regarding the item in Step 2, refer to the Function List on page 67.

Selecting a DSP Type

DSP is an abbreviation of Digital Signal Processing. These range from reverb-like ambience effects to distortion and other dynamic processing tools that let you enhance the sound, or completely transform it. The DSP effect can be added to the Main and Dual Voices. Although ON/OFF status and type selection for DSP depends on a selected Main Voice, you can set these parameters manually.

1 Press the [FUNCTION] button.

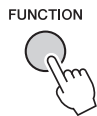

NOTE

- The volume of the currently playing Voice changes when turning DSP on or off. This is not a malfunction. The amount of change differs depending on the selected Voice.
- The DSP type is an overall setting—only one type can be selected. For this reason, when you play a newly loaded Song or Style, for example, the currently playing Voices may not sound as expected. This is normal, since the Song or Style has its own DSP type which replaces any selection you’ve made before loading. A similar phenomenon occurs when you use the [FF], [REW] buttons or A-B Repeat function during Song playback.

2 Use the CATEGORY [◀◀] and [▶▶] buttons to call up “DSP.”

The current setting is displayed.

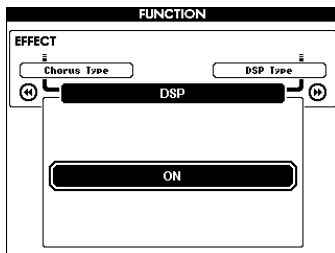

3 Use the dial to turn DSP on.

Press the [EXIT] button to return to the MAIN display in order to check the DSP on/off status.

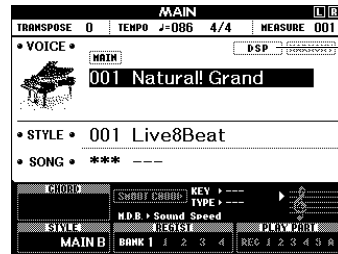

Appears when DSP is on

4 Press the [FUNCTION] button.

5 Use the CATEGORY [◀◀] and [▶▶] buttons to call up “DSP Type.”

The currently selected DSP type will be displayed.

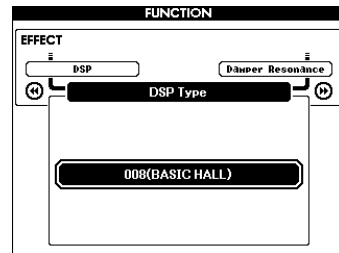

6 Use the dial to select a DSP type.

For information about the available DSP types, refer to the Effect Type List in the separate Data List.

Adjusting the DSP Level

You can adjust the DSP level applied to the Main and Dual Voices individually via the FUNCTION display. Refer to “** DSP Level” in the Function List (page 67).

Panel Sustain

This function adds sustain to the keyboard voices. Use it when you want to add sustain to the voices at all times, regardless of footswitch operation. The sustain function does not affect the Split Voice.

- 1 Press the [FUNCTION] button.

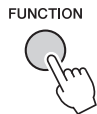

- 2 Use the CATEGORY [◀◀] and [▶▶] buttons to call up “Sustain.”

The current setting is displayed.

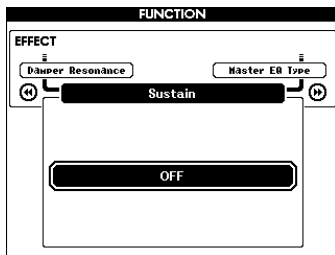

- 3 Use the dial to turn panel sustain on or off.

NOTE

- The sustain of some Voices may not be obviously or audibly affected when the panel sustain function is turned on.

Pitch Controls—Transpose

The overall pitch of the instrument (except for the Voices with name “*** Kit”) can be shifted up or down by a maximum of 1 octave in semitone increments.

- 1 Press the [FUNCTION] button.

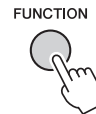

- 2 Use the CATEGORY [◀◀] and [▶▶] buttons to call up “Transpose.”

The current setting is displayed.

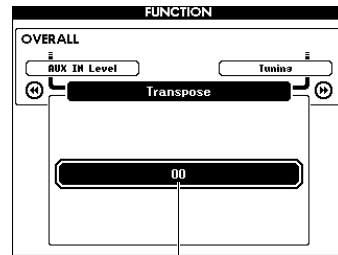

Current Transpose value

- 3 Use the dial to set the Transpose value between -12 and +12.

Pitch Controls—Tuning

The overall tuning of the instrument (except for the Voices with name “*** Kit”) can be shifted up or down between 415.3 Hz and 466.2 Hz in approximately 0.2Hz or 0.3Hz increments. The default value is 440.0 Hz.

- 1 Press the [FUNCTION] button.

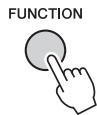

- 2 Use the CATEGORY [+] and [-] buttons to call up “Tuning.”

The current setting is displayed.

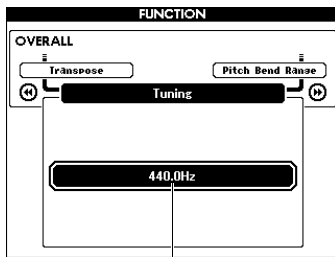

Current value

- 3 Use the dial to set the Tuning value.

Pitch Controls—the PITCH BEND wheel

The PITCH BEND wheel can be used to add smooth pitch variations to notes you play on the keyboard. Roll the wheel upward to raise the pitch, or downward to lower the pitch. You can change the amount of pitch bend produced by the wheel. Refer to “Pitch Bend Range” in the Function List (page 67).

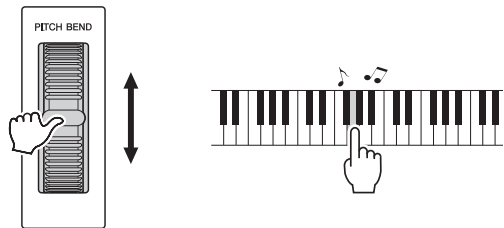

Touch Response Sensitivity

The keyboard of this instrument is equipped with a Touch Response feature that lets you dynamically and expressively control the level of the Voices according to your playing strength.

1 Press the [FUNCTION] button.

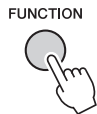

2 Use the CATEGORY [◀◀] or [▶▶] button to select “Touch Response.”

The current Touch Response sensitivity is displayed.

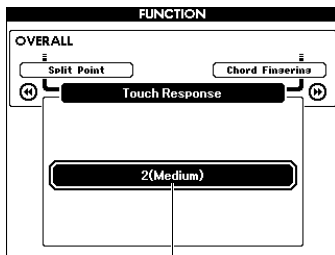

Current Touch Response sensitivity

3 Use the dial to select a Touch Response sensitivity setting between 1 and 4.

When “1 (Soft),” “2 (Medium)” or “3 (Hard)” is selected, Touch Response is active. When “4” (Fixed) is selected, all notes will be played at the same volume no matter how strongly or softly you play the keys.

1 (Soft)	With a soft touch, the instrument produces a loud sound. The volume level of tones tends to be consistent.
2 (Medium)	Standard touch response.
3 (Hard)	You must hit the key very hard to generate a loud volume. This allows for versatile expression, from pianissimo to fortissimo tones.
4 (Fixed)	No touch response. The volume level will be the same regardless of how hard you play the keys.

NOTE

- The initial default Touch Response Sensitivity value is “2.”

Selecting an EQ Setting for the Best Sound

Five different master equalizer (EQ) settings are provided to give you the best possible sound. Master Equalizer is EQ processing that is applied to the overall sound (except Audio) which is finally output from the Effect block to the speakers or headphones.

1 Press the [FUNCTION] button.

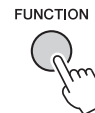

2 Press the CATEGORY [◀◀] or [▶▶] button several times until “Master EQ Type” appears.

The current Master EQ type is displayed.

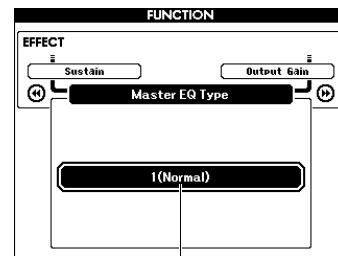

Current Master EQ type

3 Use the dial to select the desired Master EQ type.

1 (Normal)	Flat EQ settings.
2 (Piano)	Optimum for piano solo performance.
3 (Soft)	Lowers the high range for a softer sound.
4 (Bright)	Lowers the mid range for a brighter sound.
5 (Powerful)	Features more powerful sound.

NOTE

- “5 (Powerful)” produces a more punchy sound but may produce distortion depending on the Voice and Style, compared to the other Master EQ types.

Setting the Output Gain Level

Output gain level for the PHONES/OUTPUT jack can be switched between two values suitable for headphones or an external audio equipment.

- 1 Press the [FUNCTION] button.

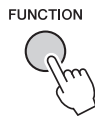

- 2 Press the CATEGORY [◀◀] or [▶▶] button several times until “Output Gain” appears.

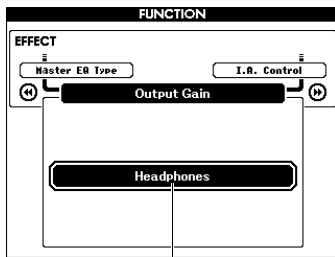

Current setting

- 3 Use the dial to select the desired setting. Select “Line Out” when using an external audio equipment, or “Headphones” when using headphones. When “Headphones” is selected and an external audio device is connected to the PHONES/OUTPUT jack, distortion may be produced.

Speaker On/Off Setting

You can set whether the sound of this instrument is always output from its built-in speaker or not when a plug is inserted to the PHONES/OUTPUT jack.

- 1 Press the [FUNCTION] button.

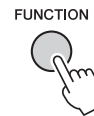

- 2 Press the CATEGORY [◀◀] or [▶▶] button several times until “Speaker Control” appears.

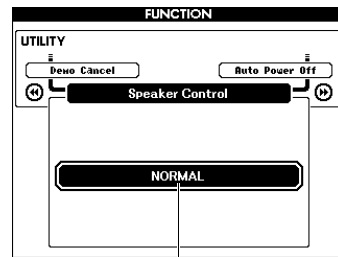

Current setting

- 3 Use the dial to select the desired setting. When “NORMAL” is selected the speakers are automatically shut off when a plug is inserted into the PHONES/OUTPUT jack. When “ALWAYS ON” is selected the speaker sound is always on regardless of whether a plug is inserted or not.

Intelligent Acoustic Control (IAC)

IAC is a function which automatically adjusts and controls the sound quality according to the overall volume of the instrument. Even when the volume is low, it permits both low sounds and high sounds to be clearly heard. IAC is effective only from the sound output of the instrument speakers. Although the default settings of IAC is set to ON, you can turn the function on or off. In addition, you can set the depth of IAC.

- 1 Press the [FUNCTION] button.

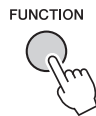

- 2 Press the CATEGORY [◀◀] or [▶▶] button several times until "I.A. Control" appears.

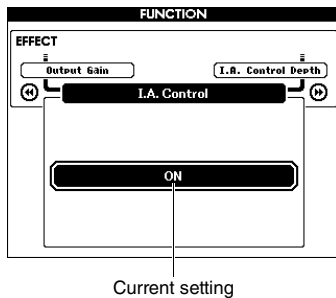

- 3 Use the dial to set the desired value.

Setting IAC Depth

You can adjust the depth of the IAC effect.

- 1 Press the [FUNCTION] button.

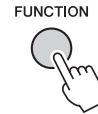

- 2 Press the CATEGORY [◀◀] or [▶▶] button several times until "I.A. Control Depth" appears.

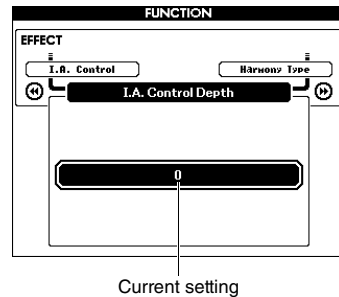

- 3 Use the dial to set the desired value.

Voice Settings

Selecting a Dual Voice

- 1 Hold down the [DUAL ON/OFF] button for longer than a second to call up the “VOICE SELECT (DUAL)” display.

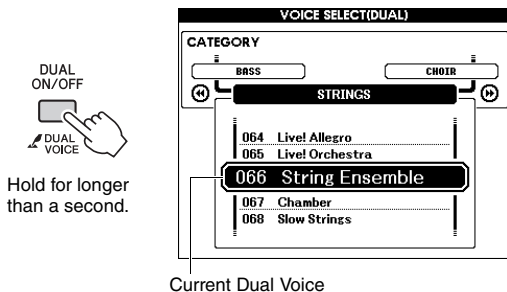

- 2 Rotate the dial to select the desired Dual Voice.

Selecting a Split Voice

- 1 Hold down the [SPLIT ON/OFF] button for longer than a second to call up the “VOICE SELECT (SPLIT)” display.

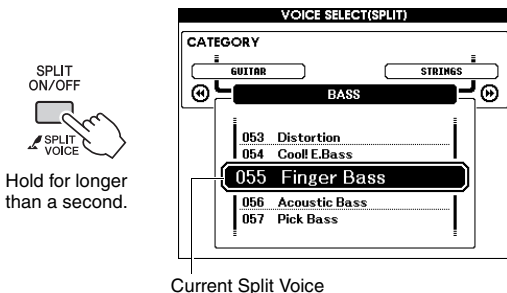

- 2 Rotate the dial to select the desired Split Voice.

Voice Editing

For each of the Main, Dual and Split Voices, you can edit the parameters such as volume, octave and depth of the Reverb and Chorus, allowing you to create new, custom sounds that best suit your musical needs.

- 1 Press the [FUNCTION] button.

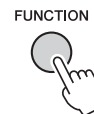

- 2 Use the CATEGORY [◀◀] or [▶▶] buttons to call up the desired item.

Main Voice parameters are indicated as “Main ***,” Dual Voice parameters as “Dual ***,” and Split Voice parameters as “Split ***.” For information about each parameter, refer to the Function List on page 67.

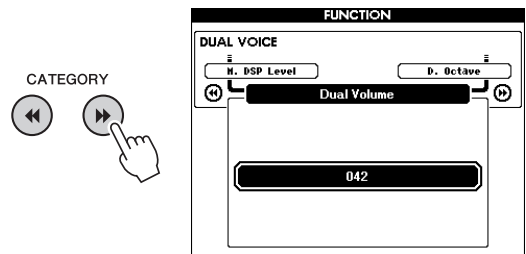

- 3 Rotate the dial to set the value.

Check the sound by playing the keyboard.

- 4 Repeat Steps 2–3 above to edit various parameters.

- 5 If necessary, memorize the settings to the Registration Memory (page 46).

The Voice-related settings are reset when a different Voice is selected. If you want to store the created sound for future recall, memorize the settings to the Registration Memory.

Style (Auto Accompaniment) Functions

Style Variations—Sections

Each Style consists of “Sections” that allow you to vary the arrangement of the accompaniment to match the performance you are playing.

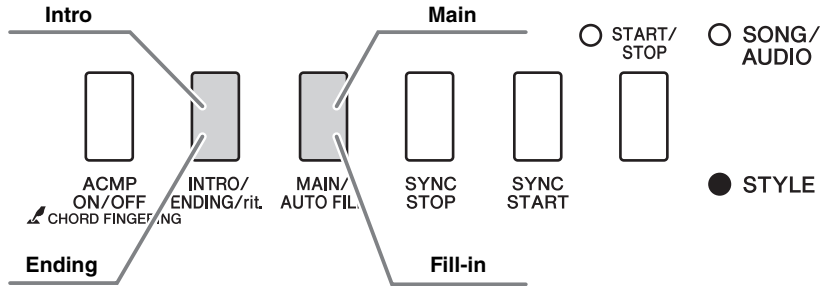

Intro

This is used for the beginning of the performance. When the Intro finishes, Style playback shifts to the Main section. The length of the Intro (in measures) differs depending on the selected Style.

Main

This is used for playing the main part of the performance. Playback of the Main section repeats indefinitely until another Section’s button is pressed. There are two variations (A and B), and the Style playback sound changes harmonically in response on the chords you play with your left hand.

Fill-in

This is automatically added before changing to Main A or B.

Ending

This is used for the ending of the performance. When the Ending finishes, Style playback stops automatically. The length of the Ending (in measures) differs depending on the selected Style.

- 1 Press the [STYLE] button, then rotate the dial to select a Style.
- 2 Press the [EXIT] button to return to the MAIN display.
- 3 Press the [ACMP ON/OFF] button to turn ACMP on.



Appears when ACMP is turned on.

- 4 Press the [SYNC START] button to turn Synchro Start on.

The indicator flashes when Synchro Start is on.

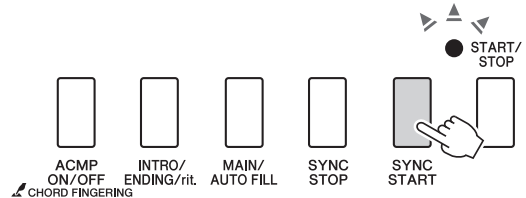

Synchro Start

When Synchro Start is on, Style playback will begin as soon as you play a chord in the Auto Accompaniment range of the keyboard. Pressing the [SYNC START] button alternately turns Synchro Start on or off.

5 Press the [MAIN/AUTO FILL] button to select Main A or Main B.

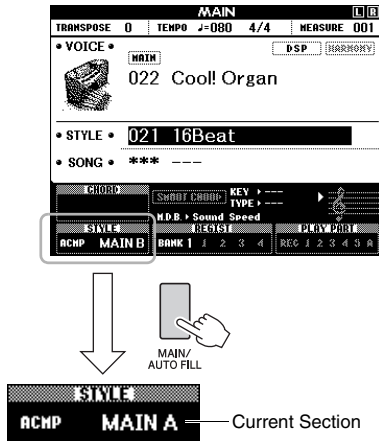

6 Press the [INTRO/ENDING/rit.] button.



Now, you're ready to start Style playback from the Intro section.

7 Play a chord with your left hand to start playback of the Intro.

For this example, play a C major chord (as shown below). For information on how to enter chords, see "Chords" on page 30.

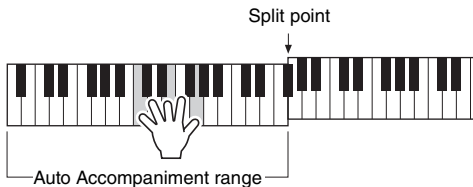

8 After the Intro finishes, play the keyboard according to the progression of the performance you are playing.

Play chords with your left hand while playing melodies with your right hand, and press the [MAIN/AUTO FILL] button as necessary. The Section will change to Fill-in then Main A or B.



9 Press the [INTRO/ENDING/rit.] button.



The Section switches to the Ending. When the Ending is finished, Style playback stops automatically. You can have the Ending gradually slow down (ritardando) by pressing the [INTRO/ENDING/rit.] button again while the Ending is playing back.

Synchro Stop

When you press the [SYNC STOP] button to turn on this function, the Style will only play while pressing chords in the Auto Accompaniment range of the keyboard. Releasing all the notes will stop Style playback. This makes it easy to add rhythmic breaks as you perform, simply by releasing your hand from the Auto Accompaniment range of the keyboard.

Pressing the [SYNC STOP] button alternately turns Synchro Stop on or off.

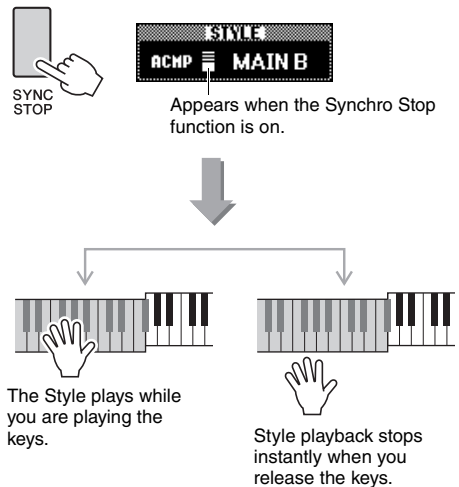

Changing the Tempo

A Style can be played at any tempo you desire—fast or slow.

- 1 Press the [TEMPO/TAP] button to call up the Tempo display.

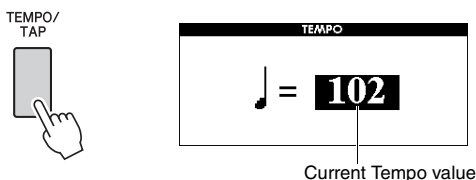

- 2 Rotate the dial to set a tempo.

Press the [+] and [-] buttons simultaneously to instantly reset the value to the default tempo of the current Style. You can change the tempo during playback by pressing the [TEMPO/TAP] button just twice at the required tempo.

NOTE

- The above operation applies also to Song playback tempo.

Tap Start

You can start play back of the Style or Song by simply tapping the [TEMPO/TAP] button at the required tempo—four times for time signatures in 4 (4/4, etc.), and three times for time signatures in 3 (3/4, etc.).

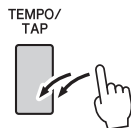

Adjusting the Volume of the Style

You can adjust the volume balance between Style playback and keyboard performance.

- 1 Press the [FUNCTION] button.

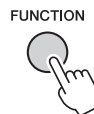

- 2 Use the CATEGORY [◀◀] and [▶▶] buttons to call up “Style Volume.”

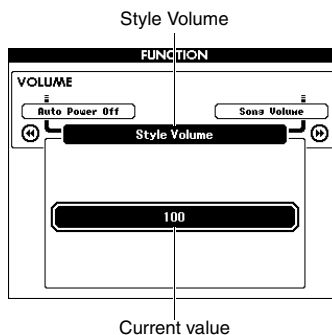

- 3 Rotate the dial to set the volume.

Playing Chords Without Style Playback

If you press the [STYLE] button, press the [ACMP ON/OFF] button to turn ACMP on (the ACMP ON icon appears), and play the chord in the left hand range of the keyboard (with SYNC START off), the chord sound will be heard without Style playback. This is referred to as “Stop Accompaniment.” The specified chord will be shown in the display, and affects the Harmony function (page 27).

Setting the Split Point

The point on the keyboard that separates the left-hand range and the right-hand range of the keyboard is called the “Split Point.”

When a Style is selected and ACMP is on, the notes played to the left of the Split Point are used to specify the chord for Style playback. When the Split function is on, the notes played to the left of the Split Point are used to play the Split Voice.

The initial default Split Point is key number 54 (the F#2 key), but you can change it to another key.

1 Press the [FUNCTION] button.

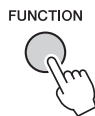

2 Use the CATEGORY [◀◀] and [▶▶] buttons to call up “Split Point.”

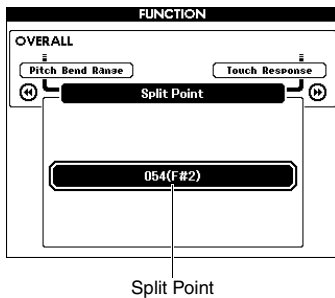

3 Rotate the dial to set the Split Point between 021 (A-1) and 108 (C7).

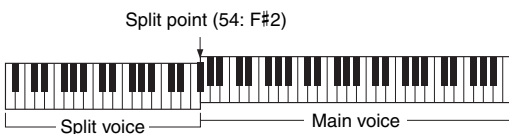

To restore the value to the default setting, press [+] / [-] buttons simultaneously.

NOTE

- The Split Point set here is applied to both the Style and Voice.
- During the Lesson playback, the Split Point cannot be changed.

Setting the Chord Fingering

There are three different Fingering Types which let you specify the chord type for Style playback or use the entire keyboard range for chord specifying.

1 Press the [STYLE] button.

2 Holding down the [ACMP ON/OFF] button for longer than a second to call up the “Chord Fingering” display.

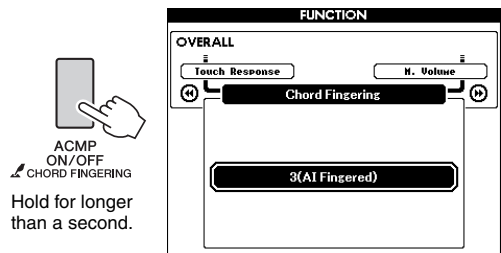

3 Use the dial to select the desired setting.

1 (Multi Finger)	Recognizes the various chord types which are listed on the separate Data List, including “Easy Chords” (this book, page 30).
2 (FullKeyboard)	Detects chords in the entire key range. Chords are detected in a way similar to 1 (Multi Finger), even if you split the notes between your left and right hands — for example, playing a bass note with your left hand and a chord with your right, or by playing a chord with your left hand and a melody note with your right. In this mode, Easy Chords cannot be detected.
3 (AI Fingered)	Less than three notes can be played to indicate the chords (based on the previously played chord, etc.).

Looking Up Chords Using the Chord Dictionary

The Dictionary function is useful when you know the name of a certain chord and want to quickly learn how to play it.

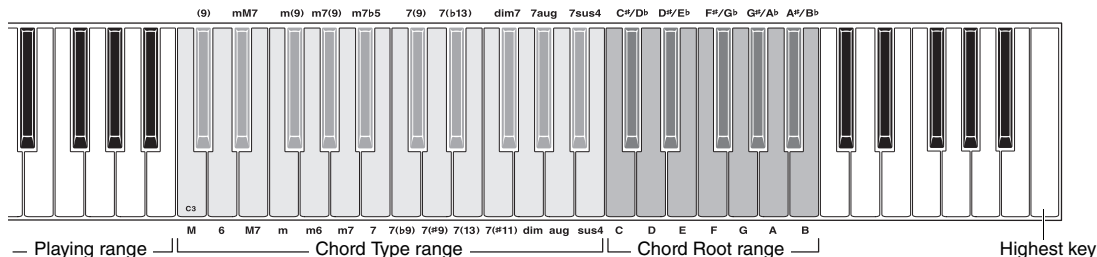

1 Press and hold the [MINUS ONE] button for longer than a second to call up the **DICTIONARY** display.

2 As an example, learn how to play a **GM7** (G major seventh) chord.

2-1 Referring to the illustration, press the G key in the “Chord Root” range so that “G” is shown as the root note (no sound will be produced).

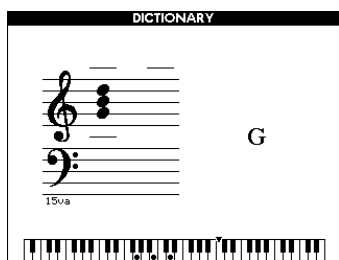

2-2 Referring to the illustration, press the M7 (major seventh) key in the “Chord Type” range (no sound will be produced). The notes you should play for the specified chord (root note and chord type) are shown in the display, both as notation and in the keyboard diagram.

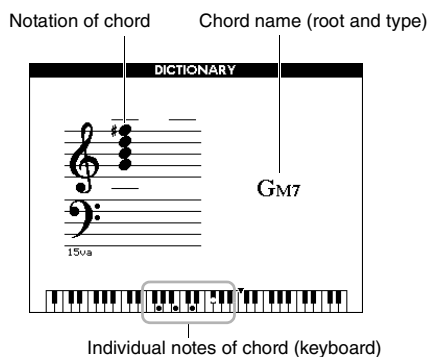
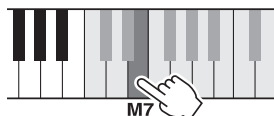

To call up possible inversions of the chord, press the [+]/[-] buttons.

NOTE

- About major chords: Simple major chords are usually indicated only by the root note. For example, “C” refers to C major. However, when specifying major chords here, make sure to select “M” (major) after pressing the root note.

3 Following the notation and keyboard diagram in the display, try playing a chord in the “Playing” range.

When you’ve played the chord properly, a bell sound signals your success and the chord name in the display will be highlighted.

To exit from this function, press the [EXIT] button.

Song and Audio Settings

Background Music (BGM) Playback

With the default setting, pressing the [DEMO/BGM] button will play back only Overview Demo Song repeatedly. This setting can be changed so that, for example, all internal Songs are played, or all Songs and Audio files on a USB flash memory are played back, letting you use the instrument as a background music source. Five playback group settings are provided. Simply select the one that suits your needs.

- 1 Hold down the [DEMO/BGM] button for longer than a second to call up the “Demo Group” display.

The current repeat playback target is shown.

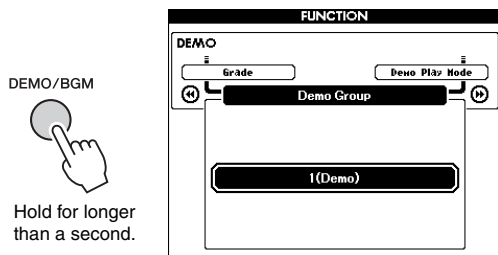

- 2 Rotate the dial to select a repeat playback group from the table below.

Demo	Overview Demo Song
Preset	All preset Songs
User	All User Songs
Download	All Songs transferred from a computer
USB	<p>All Song files (MIDI files) and Audio files in the connected USB flash memory.</p> <p>Playback Order Since the files in the root folder on a USB flash memory will be sorted in alphabetical order regardless of the file type, you can alternately playback several Songs and Audio files in order as in this example:</p> <p>Song1.mid Song1.wav Song2.mid Song2.wav</p> <p>To do so, please make sure only the files to be played back are in the root folder on a USB flash memory and there are no other files in the USB flash memory.</p>

- 3 Press the [DEMO/BGM] button to start playback.

To stop playback, press the [DEMO/BGM] button again.

Random Playback

The order of repeat playback via the [DEMO/BGM] button can be changed between numerical and random order.

- 1 Press the [FUNCTION] button.

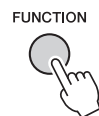

- 2 Press the CATEGORY [◀] or [▶] buttons several times to select “Demo Play Mode.”

The current playback mode, “1 (Normal)” or “2 (Random),” is shown.

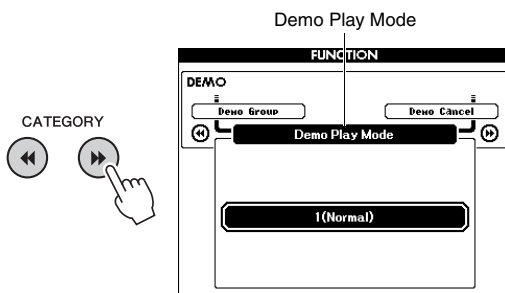

When the “Demo Group” is set to “Demo,” this parameter cannot be set.

- 3 Rotate the dial to select “2 (Random).”
To return to numerical order, select “1 (Normal).”
- 4 Press the [DEMO/BGM] button to start playback.
To stop playback, press the [DEMO/BGM] button again.

Tempo Setting of the Song

This operation is same as that of the Style. Refer to page 60.

Tap Start

This operation is same as that of the Style. Refer to page 60.

Song Volume

NOTE

- Song volume can be adjusted while a Song is selected.

1 Press the [FUNCTION] button.

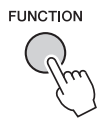

2 Press the CATEGORY [◀◀] or [▶▶] buttons several times to call up “Song Volume.”

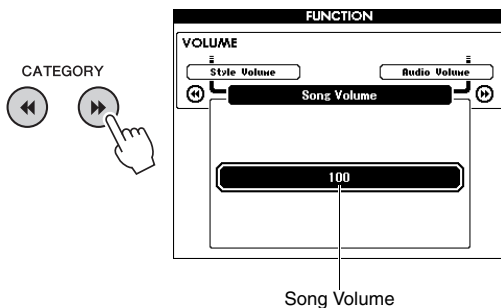

3 Rotate the dial to set the Song volume.

Audio Volume

NOTE

- Audio volume can be adjusted while an Audio file is selected.

1 Press the [FUNCTION] button.

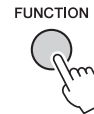

2 Press the CATEGORY [◀◀] or [▶▶] buttons several times to call up “Audio Volume.”

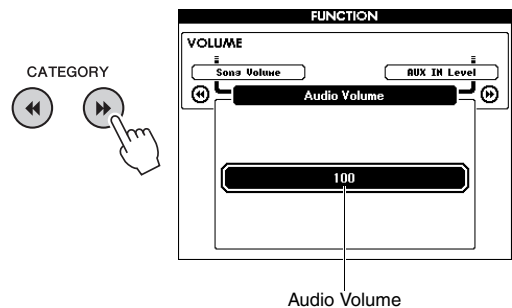

3 Rotate the dial to set the Audio volume.

Changing the Voice of the Song

You can change the Voice of Track 1 or 2 in the current Preset Song temporarily to any other desired Voice.

- 1 Press the [SONG/AUDIO] button, select the desired Preset Song, then start playback.
- 2 Hold down the [VOICE] button for longer than a second to call up the “VOICE SELECT (MELODY R)” display for selecting a Voice.

Pressing the [VOICE] button alternates the display between VOICE SELECT (MELODY R) and VOICE SELECT (MELODY L), then select the desired display. Melody R is the Track 1 Voice, and Melody L is the Track 2 Voice.

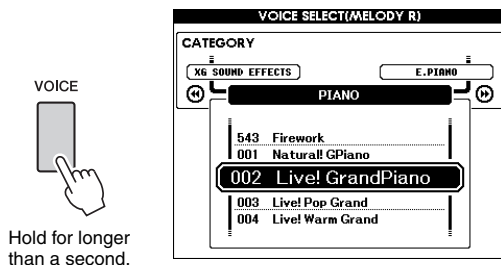

- 3 Rotate the dial to select the desired Voice.

As you select different Voices, the Melody Voice of the Song changes while the Song remains the same.

Specifying the Channel for the Lesson Part

When using external Songs (only SMF format 0 and 1) in a USB flash memory (or transferred from a computer) for lessons you can specify which channels are to be played back as the right-hand and left-hand parts. The default settings are channel 1 for the right-hand part and channel 2 for the left-hand part.

- 1 Press the [SONG/AUDIO] button and select the Song (106–) for which you want to set the guide track.

- 2 Press the [FUNCTION] button.

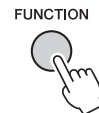

- 3 Use the CATEGORY [◀◀] and [▶▶] buttons to select the “R-Part” or “L-Part.”
- 4 Use the dial to select the channel you want to play back as the specified right- or left-hand part.

The Functions

The “Functions” provide access to a range of detailed instrument parameters such as Tuning, Split Point, Voices and Effects. Take a look at the Function List (pages 67–69). When you find the desired Function you want to change, follow the instructions below.

- 1 Find the desired item in the Function List on pages 67–69.
- 2 Press the [FUNCTION] button to call up the FUNCTION display.

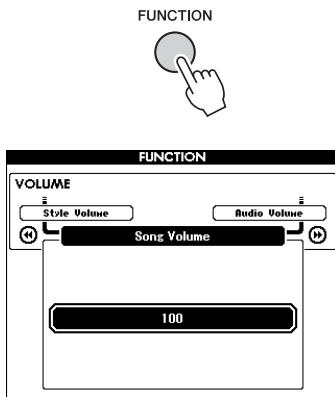

- 3 Press the CATEGORY [◀◀] or [▶▶] buttons several times until the desired item appears.

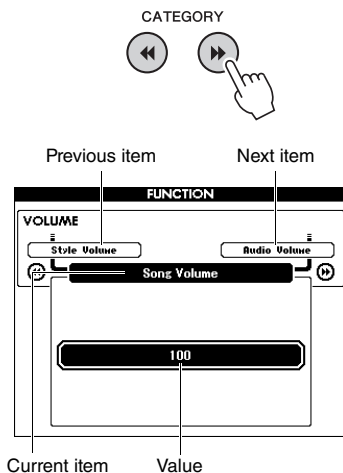

- 4 Use the dial, the [+] and [-] buttons, or the [0]–[9] number buttons to set the value of the selected function.

To restore the default value, press the [+] and [-] buttons simultaneously. In the sole case of the MIDI Initial Send function, pressing the [+] button executes the function while pressing [-] cancels it.

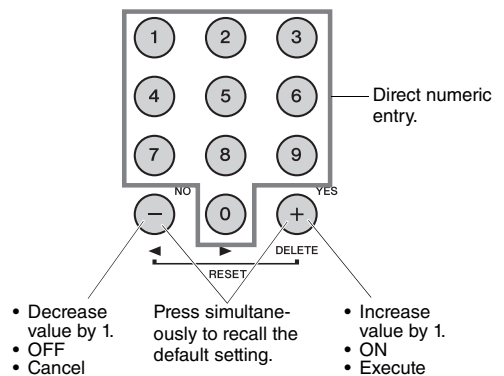

Some Function settings are maintained even if you turn off the power, and can be transferred to the computer as Backup Data (page 49).

Function List

Category	Function	Range/Settings	Default Value	Description
Volume	Style Volume	000–127	100	Refer to page 60.
	Song Volume	000–127	100	Refer to page 64.
	Audio Volume	000–127	100	Determines the volume of the Audio file.
	AUX IN Level	000–127	100	Determines the volume of the sound input via the AUX IN jack.
Overall	Transpose	-12–+12	00	Refer to page 52.
	Tuning	415.3Hz–466.2Hz	440.0Hz	Refer to page 53.
	Pitch Bend Range	01–12	02	Sets the range over which you can control pitch by using the PITCH BEND wheel (page 53), in semitone increments.
	Split Point	021 (A-1)–108 (C7)	054 (F#2)	Refer to page 61.
	Touch Response	1 (Soft)/ 2 (Medium)/ 3 (Hard)/ 4 (Fixed)	2 (Medium)	Refer to page 54.
Chord Fingering	1 (Multi Finger)/ 2 (FullKeyboard)/ 3 (AI Fingered)	1 (Multi Finger)	Refer to page 61.	
Main Voice (page 23)	Main Volume	000–127	*	Determines the volume of the Main Voice.
	Main Octave	-2–+2	*	Determines the octave range for the Main voice.
	Main Pan	000 (left)– 64 (center)– 127 (right)	*	Determines the stereo pan position of the Main Voice. A value of "0" results in the sound being panned full left; a value of "127" results in the sound being panned full right.
	Main Reverb Level	000–127	*	Determines how much of the Main Voice's signal is sent to the Reverb effect.
	Main Chorus Level	000–127	*	Determines how much of the Main Voice's signal is sent to the Chorus effect.
	Main DSP Level	000–127	*	Determines how much of the Main voice's signal is sent to the DSP effect.
Dual Voice (pages 24, 57)	Dual Volume	000–127	*	Determines the volume of the Dual Voice.
	Dual Octave	-2–+2	*	Determines the octave range for the Dual voice.
	Dual Pan	000 (left)– 64 (center)– 127 (right)	*	Determines the stereo pan position of the Dual Voice. A value of "0" results in the sound being panned full left; a value of "127" results in the sound being panned full right.
	Dual Reverb Level	000–127	*	Determines how much of the Dual Voice's signal is sent to the Reverb effect.
	Dual Chorus Level	000–127	*	Determines how much of the Dual Voice's signal is sent to the Chorus effect.
	Dual DSP Level	000–127	*	Determines how much of the Dual Voice's signal is sent to the DSP effect.
Split Voice (pages 24, 57)	Split Volume	000–127	080	Determines the volume of the Split Voice.
	Split Octave	-2–+2	0	Determines the octave range for the Split voice.
	Split Pan	000 (left)– 64 (center)– 127 (right)	064	Determines the stereo pan position of the Split Voice. A value of "0" results in the sound being panned full left; a value of "127" results in the sound being panned full right.
	Split Reverb Level	000–127	008	Determines how much of the Split Voice's signal is sent to the Reverb effect.
	Split Chorus Level	000–127	000	Determines how much of the Split Voice's signal is sent to the Chorus effect.

Category	Function	Range/Settings	Default Value	Description
Effect	Reverb Type	01–36	**	Refer to page 50.
	Chorus Type	01–45	**	Refer to page 50.
	DSP	ON/OFF	*	Refer to page 51.
	DSP Type	001–239	*	Refer to page 51.
	Damper Resonance	ON/OFF	ON	This effect is applied only to Voice 001 (Main Voice) or Voice 001 used in Track 1 of the Song. Refer to pages 16 and 18.
	Sustain	ON/OFF	OFF	Refer to page 52.
	MASTER EQ Type	1 (Normal)/ 2 (Piano)/ 3 (Soft)/ 4 (Bright)/ 5 (Powerful)	Normal	Refer to page 54.
	Output Gain	Headphones/ Line Out	Headphones	Refer to page 55.
	I. A. Control	ON/OFF	ON	Refer to page 56.
	I. A. Control Depth	-3–+3	0	Refer to page 56.
Harmony (page 27)	Harmony Type	01–26	*	Determines the Harmony type.
	Harmony Volume	000–127	*	Determines the volume of the Harmony effect.
PC (USB TO HOST terminal)	PC Mode	PC1/PC2/OFF	OFF	Optimizes the MIDI settings when transmitting or receiving the performance data between the computer and the instrument (page 69).
MIDI***	Local	ON/OFF	ON	Determines whether the instrument’s keyboard controls the internal tone generator (ON) or not (OFF). When you record your keyboard performance to the application software on the computer via MIDI, set this parameter to OFF.
	External Clock	ON/OFF	OFF	Determines whether the instrument synchronizes to the internal clock (OFF) or an external clock (ON). When you record your keyboard performance to the application software on the computer via MIDI, set this parameter to ON.
	Keyboard Out	ON/OFF	ON	Determines whether MIDI messages generated via keyboard performance are transmitted (ON) or not (OFF) from the USB TO HOST terminal.
	Style Out	ON/OFF	OFF	Determines whether MIDI messages generated via Style playback are transmitted (ON) or not (OFF) from the USB TO HOST terminal.
	Song Out	ON/OFF	OFF	Determines whether MIDI messages generated via Song playback are transmitted (ON) or not (OFF) from the USB TO HOST terminal.
	Initial Setup	ON	–	Lets you send the data of the panel settings to a computer. Press [+] to send, or press [-] to cancel during sending. This operation should be done immediately after starting the Recording operation on the computer.
Metronome (page 25)	Time Signature Numerator	1–60	**	Determines the time signature of the Metronome.
	Time Signature - Denominator	2/4/8/16	**	Determines the length of each metronome beat.
	Bell	ON/OFF	ON	Determines whether a bell accent will be sounded (ON) or not (OFF).
	Metronome Volume	000–127	100	Determines the volume of the Metronome.

Category	Function	Range/Settings	Default Value	Description
Score	Quantize	1 (1/4 note)/ 2 (1/4 note triplet)/ 3 (1/8 note)/ 4 (1/8 note triplet)/ 5 (1/16 note)/ 6 (1/16 note triplet)/ 7 (1/32 note)/ 8 (1/32 note triplet)	–	Depending on the Song data, you can make the score more readable by adjusting the timing of the notes. This determines the minimum timing resolution used in the Song. For example, if there are both quarter notes and eighth notes in the Song, you should set this value to “eighth note.” Any notes or rests shorter than this value will not be shown in the score.
Song/Lesson	Right-Part	CH 01, 02...15, 16, OFF	CH 01	Determines the guide track number for your right hand lesson. The setting is effective for Songs in SMF format 0 and 1 that are transferred from an external device.
	Left-Part	CH 01, 02...15, 16, OFF	CH 02	Determines the guide track number for your left hand lesson. The setting is effective for Songs in SMF format 0 and 1 that are transferred from an external device.
Lesson	Grade	ON/OFF	ON	Determines whether the Grade function is on or off.
Demo	Demo Group	1 (Demo)/ 2 (Preset)/ 3 (User)/ 4 (Download)/ 5 (USB)	1 (Demo)	Refer to page 63.
	Demo Play Mode	1 (Normal)/ 2 (Random)	1 (Normal)	Refer to page 63.
	Demo Cancel	ON/OFF	OFF	Determines whether Demo cancel is enabled or not. When this is set to ON, the Demo Song will not play, even if the [DEMO/BGM] button is pressed.
Utility	Speaker Control	NORMAL/ ALWAYS ON	NORMAL	Refer to page 55.
	Auto Power Off	OFF/5/10/15/30/60/ 120 (min.)	30	Refer to page 20.

* The appropriate value is automatically set for each Voice combination.

** The appropriate value is automatically set for each Song or Style.

*** For details, refer to “Computer-related Operations” (page 9).

PC Mode

The PC settings instantly reconfigure all important MIDI settings (as shown below). This setting is not necessary when transferring files between the computer and the instrument via Musicsoft Downloader.

	PC1	PC2	OFF
Local	OFF	OFF	ON
External Clock	ON	OFF	OFF
Song Out	OFF	OFF	OFF
Style Out	OFF	OFF	OFF
Keyboard Out	OFF	ON	ON

NOTE

- Preset Song data cannot be transmitted from the instrument by the Song Out function, but User Songs can.

USB Flash Memory Operations

By connecting the USB flash memory device to the USB TO DEVICE terminal, you can save the data created on this instrument, such as User Song and parameter settings. The saved data can be recalled to this instrument again for future use.

Precautions when using the USB TO DEVICE terminal

This instrument features a built-in USB TO DEVICE terminal. When connecting a USB device to the terminal, be sure to handle the USB device with care. Follow the important precautions below.

NOTE

- For more information about the handling of USB devices, refer to the owner's manual of the USB device.

Compatible USB devices

- USB flash memory

The instrument does not necessarily support all commercially available USB devices. Yamaha cannot guarantee operation of USB devices that you purchase. Before purchasing a USB device for use with this instrument, please visit the following web page:

<http://download.yamaha.com/>

NOTE

- Other USB devices such as a computer keyboard or mouse cannot be used.

Connecting USB device

- When connecting a USB device to the USB TO DEVICE terminal, make sure that the connector on the device is appropriate and that it is connected in the proper direction.

NOTICE

- Avoid connecting or disconnecting the USB device during playback/recording, file control (such as Save, Delete and Format operations) or when accessing the USB device. Failure to do so may result in "freezing" of the operation of the instrument or corruption of the USB device and the data.
- When connecting then disconnecting the USB device (and vice versa), make sure to wait a few seconds between the two operations.

NOTE

- When connecting a USB cable, make sure that the length is less than 3 meters.
- Though the instrument supports the USB 1.1 standard, you can connect and use a USB 2.0 storage device with the instrument. However, note that the transfer speed is that of USB 1.1.

Using USB flash memory

By connecting the instrument to a USB flash memory, you can save data you've created to the connected device, as well as read data from the connected USB flash memory.

Maximum number of USB flash memory allowed

Only one USB flash memory can be connected to the USB TO DEVICE terminal.

Formatting USB flash memory

When a USB flash memory is connected, a message may appear prompting you to format the USB flash memory. If so, execute the Format operation (page 72).

NOTICE

- The format operation overwrites any previously existing data. Make sure that the USB flash memory you are formatting does not contain important data.

To protect your data (write-protect)

To prevent important data from being inadvertently erased, apply the write-protect provided with each USB flash memory. If you are saving data to the USB flash memory, make sure to disable write-protect.

Turning off the instrument

When turning off the instrument, make sure that the instrument is NOT accessing the USB flash memory by playback/recording or file control (such as during Save, Delete and Format operations). Failure to do so may corrupt the USB flash memory and the data.

Connecting a USB Flash Memory

- 1 **Connect a USB flash memory to the USB TO DEVICE terminal, being careful to insert it with the proper orientation.**

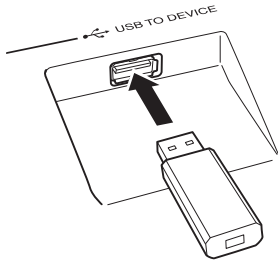

A message (information or confirmation dialog) sometimes appears on the display to facilitate operation. Refer to the “Messages” on page 79 for an explanation of each message.

- 2 **Wait for confirmation that the USB flash memory has been properly mounted.**

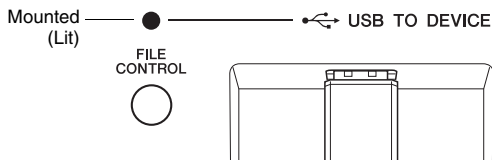
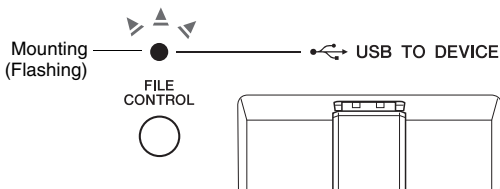

Calling up the FILE CONTROL display

Pressing the [FILE CONTROL] button while the USB flash memory is connected to the USB TO DEVICE terminal calls up the FILE CONTROL display.

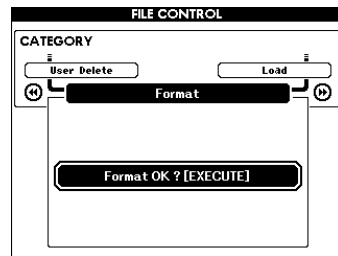

You can access file operations listed below by pressing the CATEGORY [◀◀] or [▶▶] buttons from the FILE CONTROL display.

Menu	Reference page
Format	72
Regist Save	73
User Song Save	74
Audio Save	75
Load	76
USB Delete	77
User Delete	77

If you press the [FILE CONTROL] button while an unformatted USB flash memory is connected to the instrument, the “Format” function will automatically be selected.

To exit from the FILE CONTROL display press the [EXIT] button.

NOTE

- No sound will be produced if you play the keyboard while the FILE CONTROL display is showing. Also, in this state only buttons related to file functions will be active.

NOTE

- The FILE CONTROL display will not appear in any of the following cases:
 - During Style, Song or Audio playback.
 - During Lesson and Style Recommender.
 - While data is being loaded from a USB flash memory.

Formatting a USB Flash Memory

The Format operation lets you prepare commercially available USB flash memory for use with this instrument.

NOTICE

- If a USB flash memory that contains data is formatted as described below, the data will be erased. Make sure that a USB flash memory to be formatted contains no important data before carrying out the formatting procedure.

- 1 Press the [FILE CONTROL] button to call up the FILE CONTROL display.



- 2 Use the CATEGORY [◀] or [▶] buttons to call up "Format."

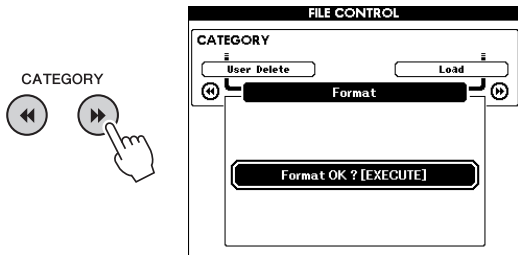

- 3 Press the [EXECUTE] button. A confirmation message will appear. To cancel the operation, press the [-] (NO) button.



- 4 Press the [EXECUTE] button again or the [+] (YES) button to execute the Format operation.

After a while, a message indicating completion of the operation appears, and the "USER FILES" folder will be created on the root directory in the USB flash memory.

NOTICE

- The Format operation cannot be cancelled during execution. Never turn off the power or disconnect the USB flash memory during the operation. Doing so may result in data loss.

- 5 Press the [EXIT] button to exit from the FILE CONTROL display.

Saving a Registration Memory to USB Flash Memory

This operation saves a Registration Memory to a USB flash memory device. The file name will have a “.usr” extension which does not appear in the instrument’s display.

- 1 Press the [FILE CONTROL] button to call up the FILE CONTROL display.



- 2 Use the CATEGORY [◀] or [▶] buttons to call up “Regist Save.”

A default file name will automatically be created.

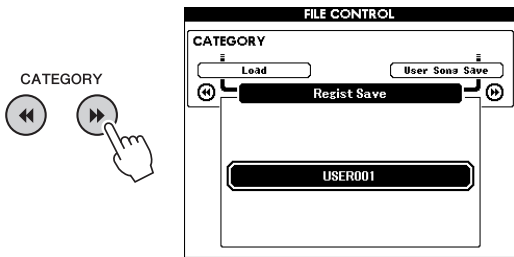

To Overwrite an Existing File

If you want to overwrite a file that already exists on the USB flash memory, use the dial or the [+] and [-] buttons to select the file, then skip ahead to step 5.

NOTE

- Up to 100 User files can be saved to a single USB flash memory.

- 3 Press the [EXECUTE] button.

A cursor will appear below the first character in the file name.

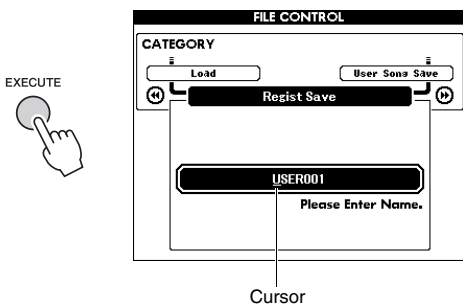

- 4 Change the file name as necessary.

The [-] button moves the cursor to the left, and the [0] button moves it to the right.

Use the dial to select a character for the current cursor location.

The [+] button deletes the character at the cursor location.

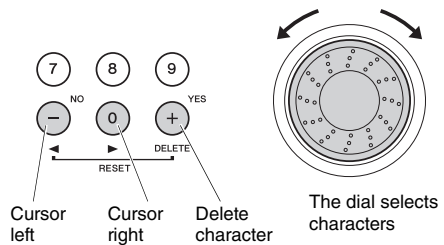

- 5 Press the [EXECUTE] button.

A confirmation message will appear. To cancel the operation, press the [-] (NO) button.

- 6 Press the [EXECUTE] button again, or the [+] (YES) button to execute the Save operation.

After a while, a message indicating completion of the operation appears.

Registration Memory will be saved in a folder labeled “USER FILES” which will automatically be created on the USB flash memory.

NOTICE

- If an existing file name is specified, the display prompts you for confirmation. Press [EXECUTE] or [+] if it is OK to overwrite the file, or [-] to cancel.

NOTICE

- The Save operation cannot be cancelled during execution. Never turn off the power or disconnect the USB flash memory during the operation. Doing so may result in data loss.

- 7 Press the [EXIT] button to exit from the FILE CONTROL display.

NOTE

- If you want to recall the Registration Memory (.usr) to this instrument again, execute the Load operation (page 76).

NOTE

- The amount of time it will take to perform the Save operation will depend on the condition of the USB flash memory.

Saving a User Song to USB Flash Memory

This operation saves a User Song (Song numbers 101–105) to USB flash memory.

- 1 Press the [FILE CONTROL] button to call up the FILE CONTROL display.



- 2 Use the CATEGORY [◀] or [▶] buttons to call up “User Song Save.”

The SOURCE FILE—a User Song name—will be highlighted.

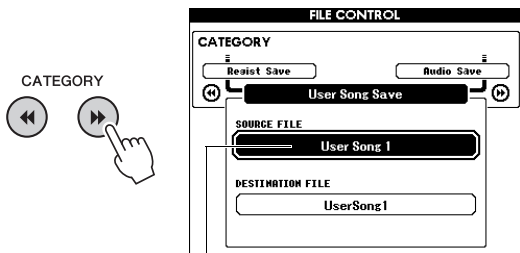

The source User Song name.

- 3 Use the dial to select the User Song you want to save.

- 4 Press the [EXECUTE] button.

The DESTINATION FILE parameter will be highlighted, and a default name will automatically be created.



To Overwrite an Existing File

If you want to overwrite a file that already exists on the USB flash memory, use the dial to select the file, then skip ahead to step 7.

- 5 Press the [EXECUTE] button.

A cursor will appear below the first character in the file name.

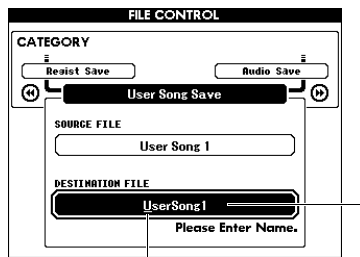

Cursor

The name of the file to be saved

- 6 Change the file name as necessary.

Refer to “Saving a Registration Memory to USB Flash Memory” on page 73 for filename entry.

- 7 Press the [EXECUTE] button.

A confirmation message will appear. To cancel the operation, press the [-] (NO) button.

- 8 Press the [EXECUTE] button again, or the [+] (YES) button to execute the Save operation.

After a while, a message indicating completion of the operation appears.

The User Song will be saved in a folder labeled “USER FILES” which will automatically be created on the USB flash memory.

NOTICE

- If an existing file name is specified, the display prompts you for confirmation. Press [EXECUTE] or [+] if it is OK to overwrite the file, or [-] to cancel.

NOTICE

- The Save operation cannot be cancelled during execution. Never turn off the power or disconnect the USB flash memory during the operation. Doing so may result in data loss.

- 9 Press the [EXIT] button to exit from the FILE CONTROL display.

NOTE

- The amount of time it will take to perform the Save operation will depend on the condition of the USB flash memory.

Converting a User Song to an Audio file

This operation converts a User Song (Song numbers 101–105) to an Audio file and saves the file to the USB flash memory.

NOTE

- Only User Songs can be converted to Audio files.

1 Press the [FILE CONTROL] button to call up the FILE CONTROL display.



2 Use the CATEGORY [◀] or [▶] buttons to call up “Audio Save.”

The SOURCE FILE—a User Song name—will be highlighted.

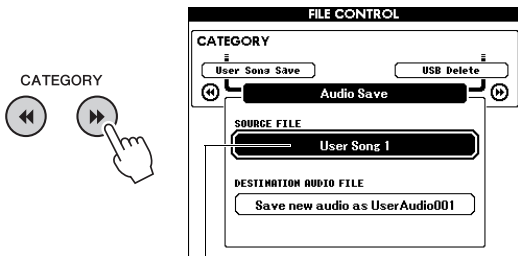

The source User Song name.

3 Use the dial to select the User Song you want to convert.

4 Press the [EXECUTE] button.

The DESTINATION AUDIO FILE parameter will be highlighted, and a default name will automatically be created.



To Overwrite an Existing File

If you want to overwrite a file that already exists on the USB flash memory, use the dial to select the file, then go on to the next step.

5 Press the [EXECUTE] button.

A confirmation message will appear. To cancel the operation, press the [-] (NO) button.

6 Press the [EXECUTE] button again, or the [+] (YES) button to execute the Save (Convert) operation.

This operation starts playback and conversion from a User Song to an audio file. If you input audio signals via the AUX IN jack during conversion, that sound also will be recorded.

After a while, a message indicating completion of the operation appears.

The Audio file will be saved in a folder labeled “USER FILES” which will automatically be created on the USB flash memory.

NOTICE

- If an existing file name is specified, the display prompts you for confirmation. Press [EXECUTE] or [+] if it is OK to overwrite the file, or [-] to cancel.

NOTICE

- Never turn off the power or disconnect the USB flash memory during the operation. Doing so may result in data loss.

7 Press the [EXIT] button to exit from the FILE CONTROL display.

NOTE

- The amount of time it takes to perform the Save operation depends on the condition of the USB flash memory.

Loading Files from a USB Flash Memory

Registration Memory, Style file and Song file (SMF) residing on a USB flash memory can be loaded into the instrument.

NOTICE

- If you load a Registration Memory, data will be overwritten by the newly loaded data. Save important data to a USB flash memory before loading data that will overwrite it.

1 Press the [FILE CONTROL] button to call up the FILE CONTROL display.



2 Use the CATEGORY [◀◀] or [▶▶] buttons to call up “Load.”

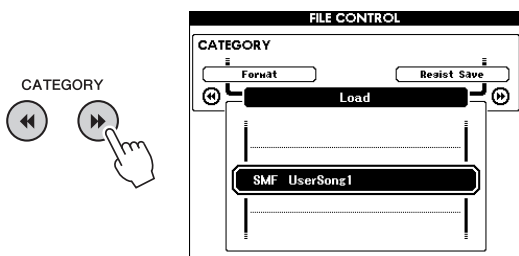

3 Use the dial to select the file you want to load.

All Registration Memory files in the USB flash memory will be displayed first, followed by the Style files and Song files. Files must be located in the “USER FILES” folder in the USB flash memory. Files located outside of that folder will not be recognized.

4 Press the [EXECUTE] button.

A confirmation message will appear. To cancel the operation, press the [-] (NO) button.



5 Press the [EXECUTE] button again, or the [+] (YES) button to execute the Load operation.

After a while, a message indicating completion of the operation appears.

NOTICE

- The Load operation cannot be cancelled during execution. Never turn off the power or disconnect the USB flash memory during the operation. Doing so may result in data loss.

6 Press the [EXIT] button to exit from the FILE CONTROL display.

Deleting files from a USB Flash Memory

This procedure deletes Registration Memory, Style file, Song file and Audio file from a USB flash memory.

- 1 Press the [FILE CONTROL] button to call up the FILE CONTROL display.
- 2 Use the CATEGORY [◀] or [▶] buttons to call up “USB Delete.”

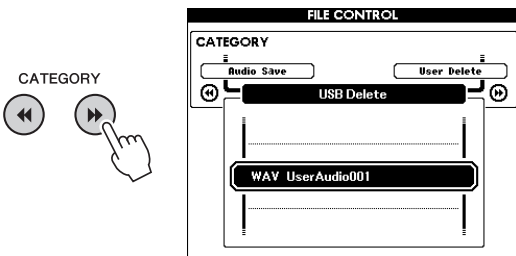

- 3 Use the dial to select the file you want to delete.

All Registration Memory files in the USB flash memory will be displayed first, followed by the Song files, Audio files and Style files. Files must be located in the “User Files” folder in the USB flash memory. Files located outside of that folder will not be recognized.

- 4 Press the [EXECUTE] button. A confirmation message will appear. To cancel the operation, press the [-] (NO) button.
- 5 Press the [EXECUTE] button again, or the [+] (YES) button to execute the Delete operation.

After a while, a message indicating completion of the operation appears.

NOTICE

- The Delete operation cannot be cancelled during execution. Never turn off the power or disconnect the USB flash memory during the operation. Doing so may result in data loss.

- 6 Press the [EXIT] button to exit from the FILE CONTROL display.

Deleting User Data from the Instrument

This procedure deletes User Song files as well as Style and Song files loaded or transferred from an external device such as a computer. This operation does not erase the Preset data.

- 1 Press the [FILE CONTROL] button to call up the FILE CONTROL display.
- 2 Use the CATEGORY [◀] or [▶] buttons to call up “User Delete.”

Only “User Delete” can be selected if no USB flash memory is connected to the instrument.

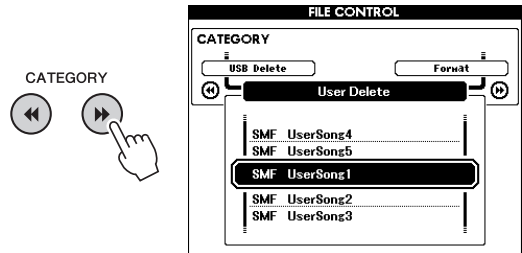

- 3 Use the dial to select the file you want to delete.

All User Songs will be displayed first, followed by the Song and Style files.

- 4 Press the [EXECUTE] button. A confirmation message will appear. To cancel the operation, press the [-] (NO) button.
- 5 Press the [EXECUTE] button again, or the [+] (YES) button to execute the Delete operation.

After a while, a message indicating completion of the operation appears.

NOTICE

- The Delete operation cannot be cancelled during execution. Never turn off the power or disconnect the USB flash memory during the operation. Doing so may result in data loss.

- 6 Press the [EXIT] button to exit from the FILE CONTROL display.

Troubleshooting

For the Instrument

Problem	Possible Cause and Solution
When the instrument is turned on or off, a popping sound is temporarily produced.	This is normal and indicates that the instrument is receiving electrical power.
The power is automatically turned off.	This is normal and due to the Auto Power Off function. If necessary, set the parameter of the Auto Power Off function (page 20).
When using a mobile phone, noise is produced.	Using a mobile phone in close proximity to the instrument may produce interference. To prevent this, turn off the mobile phone or use it further away from the instrument.
Noise is heard from the instrument's speakers or headphones when using the instrument with an iPhone/iPad application.	When you use the instrument along with an iPhone/iPad application, we recommend that you set "Airplane Mode" to "ON" on your iPhone/iPad in order to avoid noise caused by communication.
There is no sound even when the keyboard is played or when a Style or Song is being played back.	Check that nothing is connected to the PHONES/OUTPUT jack on the rear panel. When a plug is connected to this jack, no sound is output.
	Check the Local Control on/off setting. (See page 68.)
	Is the FILE CONTROL display showing? The instrument's keyboard, etc., will not produce any sound while the FILE CONTROL display is showing. Press the [EXIT] button to return to the MAIN display.
Playing keys in the right hand area of the keyboard does not produce any sound.	When using the Dictionary function (page 62), the keys in the right hand area are used only for entering the chord root and type.
The Style or Song does not play back when the [START/STOP] button is pressed.	Is External Clock set to ON? Make sure External Clock is set to OFF; refer to "External Clock" on page 68.
The Style does not sound properly.	Make sure that the Style Volume (page 60) is set to an appropriate level.
	Is the Split Point set at an appropriate key for the chords you are playing? Set the Split Point at an appropriate key (page 61). Is the "ACMP" indicator showing in the display? If it is not showing press the [ACMP ON/OFF] button so that it does show.
No rhythm accompaniment plays when the [START/STOP] button is pressed after selecting style number 165 or a style between 178–195 (Pianist).	This is not a malfunction. Style number 165 and style numbers 178–195 (Pianist) have no rhythm parts, so no rhythm will play. The other parts will begin playing when you play a chord in the accompaniment range of the keyboard if the ACMP is turned on.
Not all of the voices seem to sound, or the sound seems to be cut off.	The instrument is polyphonic up to a maximum of 128 notes. If the Dual Voice or Split Voice is being used and a Style or Song is playing back at the same time, some notes/sounds may be omitted (or "stolen") from the accompaniment or Song.
The footswitch (for sustain) seems to produce the opposite effect. For example, pressing the footswitch cuts off the sound and releasing it sustains the sounds.	The polarity of the footswitch is reversed. Make sure that the footswitch plug is properly connected to the SUSTAIN jack before turning on the power.
The sound of the Voice changes from note to note.	This is normal. The AWM tone generation method uses multiple recordings (samples) of an instrument across the range of the keyboard; thus, the actual sound of the Voice may be slightly different from note to note.
The appropriate display does not appear when the [SONG/AUDIO], [STYLE], or [VOICE] button is pressed.	Is another display showing? Try pressing the [EXIT] button to return to the MAIN display, and then pressing one of the mentioned buttons.
The ACMP indicator does not appear when the [ACMP ON/OFF] button is pressed.	Always press the [STYLE] button first when you are going to use any Style-related function.
The "Over Current" message is shown in the upper left area of the MAIN display and the USB device does not respond.	Communication with the USB device has been shut down because of the overcurrent to the USB device. Disconnect the device from the USB TO DEVICE terminal, then turn on the power of the instrument.
The Headphone sound is too low.	Make sure the parameter of "Output Gain Level" is set to "Headphones" (page 55).

Messages

LCD Message	Comment
Access error!	Indicates the failure in reading or writing from/to the media or the flash memory.
Clearing all memory...	Displayed while erasing all data in the flash memory. Never turn the power off during data transmission.
Data Error!	Displayed when the Song or Style contains illegal data.
File information area is not large enough.	Indicates that saving data in the media cannot be executed since the total number of files have become too many.
File is not found.	Indicates there is no file.
File too large. Loading is impossible.	Indicates that loading data cannot be executed since the file data is too large.
Media capacity is full.	Displayed when saving data cannot be executed since the media memory has become full.
Memory Full	Displayed when the internal memory becomes full during Song recording.
MIDI receive buffer overflow.	Displayed when too much MIDI data was received at one time and failed to proceed.
Over Current	Communication with the USB device has been shut down because of the overcurrent to the USB device. Disconnect the device from the USB TO DEVICE terminal, then turn on the power of the instrument.
Save OK ? [YES]/[NO]	Confirms whether saving is executed or not. Press the [+] (YES) button to save the recorded Song. To cancel saving, press the [-] (NO) button at the prompt.
Save data is not found.	Displayed when the data to be saved doesn't exist.
Since the media is in use now, this function is not available.	Indicates that the file control function is currently unavailable since the media is being accessed.
Since the recorded song has not been saved, the operation cannot be performed.	This message appears if you attempt to convert the User Song to audio file when there is any recorded Song which is not saved. When this message appears, press the [EXIT] button to exit from the FILE CONTROL display, then save the recorded Song which is not saved. To save the Song, hold down the [REC] button until the save confirmation message appears, then press the [+] (YES) button.
The limit of the media has been reached.	Indicates that saving data cannot be executed since the folder/directory structure has become too complicated.
The media is not formatted.	Indicates the inserted media has not been formatted.
The media is write-protected.	Indicates that the inserted media cannot be written since it is write-protected. Set to the write-protect switch to the "overwrite" position before use.
The notation cannot be displayed, since this song is not allowed to display the notation.	This message will appear if you attempt to display the score of a Song for which score display is prohibited.
The song data is too large to be converted to notation.	Indicates that the score cannot be displayed since the Song data is too large.
The number of files exceeds the system limit. Delete existing files to add new ones.	Indicates that saving data cannot be executed since the total number of files exceeds the capacity.
This drive is busy now.	This message appears when processing lags behind Audio playback or recording.
This function is not available now.	Indicates the designated function is not available since the instrument is executing another job.

NOTE

- Not all the messages are listed in the table; only messages needing explanation are included.

Specifications

Size/Weight	Dimensions	(W x D x H)	1,397 x 445 x 146 mm (55" x 17-1/2" x 5-3/4") with keyboard stand: 1,399 x 445 x 761 mm (55-1/16" x 17-1/2" x 29-15/16")
	Weight		22.5kg (49 lbs. 10 oz.) with keyboard stand: 29.5kg (65 lbs. 1 oz.)
Control Interface	Keyboard	Number of Keys	88
		Type	Graded Hammer Standard (GHS) Keyboard
		Touch Response	Soft, Medium, Hard, Fixed
	Other Controllers	Pitch Bend	Yes
		Display	Type
	Size		320 x 240 dots
	Color		Monochrome
	Contrast		Yes
	Score Display Function		Yes
	Lyrics Display Function		Yes
Panel	Language	English	
	Language	English	
Voices	Tone Generation	Piano Sound	Pure CF Sound Engine
		Damper Resonance	Yes
	Polyphony	Number of Polyphony (Max.)	128
	Preset	Number of Voices	147 + 15 Drum/SFX Kits + 381 XGLite
		Featured Voices	1 Natural! Voice, 9 Live! Voices, 8 Sweet! Voices, 7 Cool! Voices
Compatibility		GM, XGLite	
Effects	Types	Reverb	35 types
		Chorus	44 types
		DSP	237 types
		Master EQ	5 types
		Intelligent Acoustic Control (IAC)	Yes
	Functions	Dual	Yes
		Split	Yes
	Panel Sustain	Yes (Function Menu)	
Accompaniment Styles	Preset	Number of Preset Styles	195
		Fingering	Multi Finger, Full Keyboard, AI Fingered
		Style Control	INTRO, MAIN x 2, FILL-IN, ENDING
	External Styles		Yes (SFF GE)
	Other Features	Music Database	305
		One Touch Setting (OTS)	Yes
Style Recommender		Yes	
	Smart Chord	Yes	
Songs	Preset	Number of Preset Songs	100
		Number of Songs	5
	Recording	Number of Tracks	6 (5 Melody + 1 Chord)
		Data Capacity	Approx. 30,000 notes for 1 user song (when only "melody" tracks are recorded)
	Compatible Data Format	Playback	SMF (Format 0, Format 1), XF
Recording		SMF (Format 0)	
Audio Recorder	Length of Recording (max.)		80 minutes per single recording
	Compatible Data Format	Playback	.wav
		Recording	.wav
Functions	Registration	Number of Buttons	4 (x 8 banks)
	Lesson	Yamaha Education Suite (Y.E.S.)	Waiting, Your tempo, Minus one, Repeat & Learn, Chord Dictionary
	Demo	Demonstration	Yes
	Overall Controls	Metronome	Yes
		Tempo Range	5–280
		Transpose	-12 to 0, 0 to +12
		Tuning	Yes
	Miscellaneous	PIANO Button	Portable Grand Button

Storage and Connectivity	Storage	Internal Memory	Approx. 1.7 MB
		External Drives	USB Flash Memory
	Connectivity	DC IN	DC IN 12V
		Headphones/Output	x 1
		Sustain Pedal	x 1
		Pedal Unit	x 1
		USB TO DEVICE	Yes
		USB TO HOST	Yes
AUX IN (Stereo Mini)	Yes		
Amplifiers and Speakers	Amplifiers	6W x 2	
	Speakers	12cm x 2 + 5cm x 2	
Power Supply	Power Supply	Adaptor (PA-150 or the equivalent)	
	Power Consumption	13W	
Accessories	Included Accessories	<ul style="list-style-type: none"> • Owner's Manual • Data List • Keyboard Stand • Footswitch • Music Rest • AC Power Adaptor (PA-150 or an equivalent recommended by Yamaha) *1 • Online Member Product Registration *2 <p>*1: May not be included depending on your particular locale. Check with your Yamaha dealer. *2: The PRODUCT ID on the sheet will be needed when you fill out the User Registration form.</p>	
	Optional Accessories (May not be available depending on your locale.)	<ul style="list-style-type: none"> • AC Power Adaptor: <ul style="list-style-type: none"> - Users within U.S.A. or Europe: PA-150 or an equivalent recommended by Yamaha - Others: PA-5D, PA-150 or an equivalent • Headphones: HPE-150 • Pedal Unit: LP-7A/7AWH • Footswitch: FC4/5 • USB MIDI Interface for iPhone/iPod touch/iPad: i-UX1 	

* Specifications and descriptions in this owner's manual are for information purposes only. Yamaha Corp. reserves the right to change or modify products or specifications at any time without prior notice. Since specifications, equipment or options may not be the same in every locale, please check with your Yamaha dealer.

Symbols

[-] and [+] buttons 22

A

A-B Repeat 36
 Accessories 9
 ACMP 28
 Assembly 10
 Audio 34, 63
 Audio Player 48
 AUDIO SELECT display 35
 Auto Accompaniment 28
 Auto Accompaniment range 28
 Auto Power Off 20

B

Backup 49
 Bank number 46
 Bell 26

C

CATEGORY buttons 22
 Channel 65
 Chord Dictionary 62
 Chord Fingering 30, 61
 Chorus 50
 Compatible Format 8
 Computer 19
 Connection 16, 48, 70
 Convert 75

D

Damper Resonance 16, 18
 Delete (from flash memory) 77
 Delete (from USB flash memory) .. 77
 Delete (User Song) 44
 Demo 34
 Demo Group 63
 Dial 22
 DSP 51
 Dual Voice 24, 57

E

Effect 50
 Ending 58
 EQ 54
 Evaluation (lesson) 39

F

Fast Forward 36
 File Control 71
 Fill-in 58
 Footswitch 16
 Format (USB flash memory) 72
 FUNCTION display 66
 Function List 67
 Functions 66

G

Grade 39

H

Harmony 27
 Headphones 17

I

Initialization 49
 Intelligent Acoustic Control (IAC) ... 56
 Intro 58

L

Lesson 38
 Load 76
 Lyrics 37

M

Main 58
 MAIN Display 21
 Main Voice 23
 Memory number 46
 Messages 79
 Metronome 25
 MIDI 40, 68
 Music Database 29
 Music Rest 9
 Mute 36

N

Number buttons 22

O

Output Gain Level 55
 Overview Demo 34

P

Panel Settings 46
 Panel Sustain 52
 Pause 36
 Pedal Unit 18
 Piano Voice 23
 Pitch 52, 53
 PITCH BEND wheel 53
 Power On/Off 19
 Power Requirements 16
 Practice 38
 “Press & Hold” 15

R

Random Playback 63
 Recording (Audio) 45
 Recording (Song Track) 42
 Recording (Song) 40
 Registration Memory 46
 Repeat & Learn 39

Repeat Playback 36
 Reverb 50
 Rewind 36
 Rhythm 28

S

Save (to USB flash memory) .. 73, 74
 Score 37
 Sections 58
 Smart Chord 31
 Song 34, 63
 SONG SELECT display 35
 Speaker On/Off 55
 Split Point 24, 28, 61
 Split Voice 24, 57
 Stop Accompaniment 60
 Style 28, 58
 Style Recommender 33
 Sustain 52
 Synchro Start 29, 58
 Synchro Stop 59

T

Tap Start (Song) 64
 Tap Start (Style) 60
 Tempo (Song) 35
 Tempo (Style) 60
 Time Signature 25
 Touch Response 54
 Track On/Off 36
 Transpose 52
 Tuning 53

U

USB Flash Memory 70
 USER FILES folder 72, 73, 76
 User Song 40

V

Voice 23, 57
 Volume (Audio) 64
 Volume (Main Voice, Dual Voice,
 Split Voice) 67
 Volume (Master) 20
 Volume (Song) 64
 Volume (Style) 60



**LIMITED 3-YEAR WARRANTY ON
DIGITAL PIANOS
(P, CP, YDP, DGX640, DGX650)**

Thank you for selecting a YAMAHA product. YAMAHA products are designed and manufactured to provide a high level of defect-free performance. Yamaha Corporation of America ("YAMAHA") is proud of the experience and craftsmanship that goes into each and every YAMAHA product. YAMAHA sells its products through a network of reputable, specially authorized dealers and is pleased to offer you, the Original Owner, the following Limited Warranty, which applies only to products that have been (1) directly purchased from YAMAHA's authorized dealers in the fifty states of the USA and District of Columbia (the "Warranted Area) and (2) used exclusively in the Warranted Area. YAMAHA suggests that you read the Limited Warranty thoroughly, and invites you to contact your authorized YAMAHA dealer or YAMAHA Customer Service if you have any questions.

Coverage: YAMAHA will, at its option, repair or replace the product covered by this warranty if it becomes defective, malfunctions or otherwise fails to conform with this warranty under normal use and service during the term of this warranty, without charge for labor or materials. Repairs may be performed using new or refurbished parts that meet or exceed YAMAHA specifications for new parts. If YAMAHA elects to replace the product, the replacement may be a reconditioned unit. You will be responsible for any installation or removal charges and for any initial shipping charges if the product(s) must be shipped for warranty service. However, YAMAHA will pay the return shipping charges to any destination within the USA if the repairs are covered by the warranty. This warranty does not cover (a) damage, deterioration or malfunction resulting from accident, negligence, misuse, abuse, improper installation or operation or failure to follow instructions according to the Owner's Manual for this product; any shipment of the product (claims must be presented to the carrier); repair or attempted repair by anyone other than YAMAHA or an authorized YAMAHA Service Center; (b) any unit which has been altered or on which the serial number has been defaced, modified or removed; (c) normal wear and any periodic maintenance; (d) deterioration due to perspiration, corrosive atmosphere or other external causes such as extremes in temperature or humidity; (e) damages attributable to power line surge or related electrical abnormalities, lightning damage or acts of God; or (f) RFI/EMI (Interference/noise) caused by improper grounding or the improper use of either certified or uncertified equipment, if applicable. Any evidence of alteration, erasing or forgery of proof-of-purchase documents will cause this warranty to be void. This warranty covers only the Original Owner and is not transferable.

In Order to Obtain Warranty Service: Warranty service will only be provided for defective products within the Warranted Area. Contact your local authorized YAMAHA dealer who will advise you of the procedures to be followed. If this is not successful, contact YAMAHA at the address, telephone number or website shown below. YAMAHA may request that you send the defective product to a local authorized YAMAHA Servicer or authorize return of the defective product to YAMAHA for repair. If you are uncertain as to whether a dealer has been authorized by YAMAHA, please contact YAMAHA's Service Department at the number shown below, or check Yamaha's website at www.usa.yamaha.com. Product(s) shipped for service should be packed securely and must be accompanied by a detailed explanation of the problem(s) requiring service, together with the original or a machine reproduction of the bill of sale or other dated, proof-of-purchase document describing the product, as evidence of warranty coverage. Should any product submitted for warranty service be found ineligible therefore, an estimate of repair cost will be furnished and the repair will be accomplished only if requested by you and upon receipt of payment or acceptable arrangement for payment.

Limitation of Implied Warranties and Exclusion of Damages: ANY IMPLIED WARRANTIES, INCLUDING WARRANTIES OF MERCHANTABILITY AND FITNESS FOR A PARTICULAR PURPOSE SHALL BE LIMITED IN DURATION TO THE APPLICABLE PERIOD OF TIME SET FORTH ABOVE. YAMAHA SHALL NOT BE RESPONSIBLE FOR INCIDENTAL OR CONSEQUENTIAL DAMAGES OR FOR DAMAGES BASED UPON INCONVENIENCE, LOSS OF USE, DAMAGE TO ANY OTHER EQUIPMENT OR OTHER ITEMS AT THE SITE OF USE OR INTERRUPTION OF PERFORMANCES OR ANY CONSEQUENCES THEREOF. YAMAHA'S LIABILITY FOR ANY DEFECTIVE PRODUCT IS LIMITED TO REPAIR OR REPLACEMENT OF THE PRODUCT, AT YAMAHA'S OPTION. SOME STATES DO NOT ALLOW LIMITATIONS ON HOW LONG AN IMPLIED WARRANTY LASTS OR THE EXCLUSION OR LIMITATION OF INCIDENTAL OR CONSEQUENTIAL DAMAGES, SO THE ABOVE LIMITATION OR EXCLUSION MAY NOT APPLY TO YOU. This Warranty gives you specific legal rights, and you may also have other rights which vary from state to state. This is the only express warranty applicable to the Product specified herein; Yamaha neither assumes nor authorizes anyone to assume for it any other express warranty.

If you have any questions about service received or if you need assistance in locating an authorized YAMAHA Servicer, please contact:



CUSTOMER SERVICE
Yamaha Corporation of America
6600 Orangethorpe Avenue, Buena Park, California 90620-1373
Telephone: 800-854-1569
www.usa.yamaha.com

Do not return any product to the above address without a written Return Authorization issued by YAMAHA.

© 2013 Yamaha Corporation of America.

Important Notice: Guarantee Information for customers in European Economic Area (EEA) and Switzerland

Important Notice: Guarantee Information for customers in EEA* and Switzerland For detailed guarantee information about this Yamaha product, and Pan-EEA* and Switzerland warranty service, please either visit the website address below. (Printable file is available at our website) or contact the Yamaha representative office for your country. *EEA: European Economic Area	English
Wichtiger Hinweis: Garantie-Information für Kunden in der EWR* und der Schweiz Für nähere Garantie-Information über dieses Produkt von Yamaha, sowie über den Pan-EWR*- und Schweizer Garantieservice, besuchen Sie bitte entweder die folgend angegebene Internetadresse (eine druckfähige Version befindet sich auch auf unserer Webseite), oder wenden Sie sich an den für Ihr Land zuständigen Yamaha-Vertrieb. *EWR: Europäischer Wirtschaftsraum	Deutsch
Remarque importante: informations de garantie pour les clients de l'EEE et la Suisse Pour des informations plus détaillées sur la garantie de ce produit Yamaha et sur le service de garantie applicable dans l'ensemble de l'EEE ainsi qu'en Suisse, consultez notre site Web à l'adresse ci-dessous (le fichier imprimable est disponible sur notre site Web) ou contactez directement Yamaha dans votre pays de résidence. *EEE: Espace Economique Européen	Français
Belangrijke mededeling: Garantie-informatie voor klanten in de EER* en Zwitserland Voor gedetailleerde garantie-informatie over dit Yamaha-product en de garantieservice in heel de EER* en Zwitserland, gaat u naar de onderstaande website (u vindt een afdrukbaar bestand op onze website) of neemt u contact op met de vertegenwoordiging van Yamaha in uw land. *EER: Europese Economische Ruimte	Nederlands
Aviso importante: información sobre la garantía para los clientes del EEE* y Suiza Para una información detallada sobre este producto Yamaha y sobre el soporte de garantía en la zona EEE*, y Suiza, visite la dirección web que se incluye más abajo (la versión del archivo para imprimir está disponible en nuestro sitio web) o póngase en contacto con el representante de Yamaha en su país. *EEE: Espacio Económico Europeo	Español
Aviso importante: informazioni sulla garanzia per i clienti residenti nell'EEA* e in Svizzera Per informazioni dettagliate sulla garanzia relativa a questo prodotto Yamaha e l'assistenza in garanzia nei paesi EEA* e in Svizzera, potete consultare il sito Web all'indirizzo riportato di seguito (è disponibile il file in formato stampabile) oppure contattate l'ufficio di rappresentanza locale della Yamaha. *EEA: Area Economica Europea	Italiano
Aviso importante: informações sobre as garantias para clientes da AEE* e da Suíça Para obter uma informação pormenorizada sobre este produto da Yamaha e sobre o serviço de garantia na AEE* e na Suíça, visite o site a seguir (o arquivo para impressão está disponível no nosso site) ou entre em contato com o escritório de representação da Yamaha no seu país. *AEE: Área Económica Europeia	Português
Σημαντική σημείωση: Πληροφορίες εγγύησης για τους πελάτες στον ΕΟΧ* και Ελβετία Για λεπτομερείς πληροφορίες εγγύησης σχετικά με το παρόν προϊόν της Yamaha και την κάλυψη εγγύησης σε όλες τις χώρες του ΕΟΧ και την Ελβετία, επισκεφτείτε την παρακάτω ιστοσελίδα (Εκτυπώσιμη μορφή είναι διαθέσιμη στην ιστοσελίδα μας) ή απευθυνθείτε στην αντιπροσωπεία της Yamaha στη χώρα σας. *ΕΟΧ: Ευρωπαϊκός Οικονομικός Χώρος	Ελληνικά
Viktigt: Garantiinformasjon for kunder i EES-området* och Schweiz For detaljert informasjon om denne Yamaha-produktet samt garantieservice i hele EES-området* og Sveits kan du antingen besøke nedenstående webadresse (en utskriftsværdig fil finnes på webbladet) eller kontakta Yamahas offisielle representant i ditt land. *EES: Europeiska Ekonomska Samarbeidsområdet	Svenska
Viktig merknad: Garantiinformasjon for kunder i EØS* og Sveits Detaljert garantiinformasjon om dette Yamaha-produktet og garantieservice for hele EØS-området* og Sveits kan fås enten ved å besøke nettstedene nedenfor (utskriftsversjon finnes på våre nettsider) eller kontakte kontakta Yamaha-kontoret i landet der du bor. *EØS: Det europeiske økonomiske samarbeidsområdet	Norsk
Vigtig oplysning: Garantioplysninger til kunder i EØO* og Schweiz De kan finde detaljerede garantioplysninger om dette Yamaha-produkt og den fælles garantieserviceordning for EØO* (og Schweiz) ved at besøge det websted, der er angivet nedenfor (der findes en fil, som kan udskrives, på vores websted), eller ved at kontakte Yamahas nationale repræsentationskontor i det land, hvor De bor. *EØO: Det Europæiske Økonomiske Samarbejdsområde	Dansk

Tärkeä ilmoitus: Takuuehdot Euroopan talousalueen (ETA)* ja Sveitsin asiakkaille Tämän Yamaha-tuotteen sekä ETA-alueen ja Sveitsin takuuta koskevat yksityiskohtaiset tiedot saatte alla olevasta nettiosoitteesta. (Tulostettava liidosto saatavissa sivustollamme.) Voitte myös ottaa yhteyttä paikalliseen Yamaha-edustajalleen. *ETA: Euroopan talousalue	Suomi
Ważne: Warunki gwarancyjne obowiązujące w EOG* i Szwajcarii Aby dowiedzieć się więcej na temat warunków gwarancyjnych tego produktu firmy Yamaha i serwisu gwarancyjnego w całym EOG* i Szwajcarii, należy odwiedzić wskazaną poniżej stronę internetową (plik gotowy do wydruku znajduje się na naszej stronie internetowej) lub skontaktować się z przedstawicielstwem firmy Yamaha w swoim kraju. *EOG — Europejski Obszar Gospodarczy	Polski
Důležitě oznámení: Záruční informace pro zákazníky v EHS* a ve Švýcarsku Podrobnější informace o tomto produktu Yamaha a záručním servisu v celém EHS* a ve Švýcarsku naleznete na níže uvedené webové adrese (soubor k tisku je dostupný na našich webových stránkách) nebo se můžete obrátit na zastoupení firmy Yamaha ve své zemi. *EHS: Evropský hospodářský prostor	Česky
Fontos figyelemzés: Garancia-információk az EGT* területén és Svájcban élő vásárlók számára A jelen Yamaha termékre vonatkozó részletes garancia-információk, valamint az EGT*-re és Svájcra kiterjedő garanciális szolgáltatás tekintetében keressék fel webhelyünket az alábbi címen (a webhelyen nyomtatható fájl is talál), vagy pedig lépjen kapcsolatba az országában működő Yamaha képviselőirodával. *EGT: Európai Gazdasági Térség	Magyar
Oluline märkus: Garantiteave Euroopa Majanduspiirkonna (EMP)* ja Šveitsi klientidele Täpsema teabe saamiseks selle Yamaha toote garantii ning kogu Euroopa Majanduspiirkonna ja Šveitsi garantiteeninduse kohta, külastage palun veebilehti alljärgneval aadressil (meie saidil on saadaval printitav fail) või pöörduge Teie riigioni Yamaha esinduse poole. *EMP: Euroopa Majanduspiirkond	Eesti keel
Svarigs paziņojums: garantijas informācija klientiem EEZ* un Šveicā Lai saņemtu detalizētākas garantijas informāciju par šo Yamaha produktu, kā arī garantijas apkalpošanu EEZ* un Šveicā, lūdzam apmeklēt zemāk norādīto tīmekļa vietnes adresi (tīmekļa vietnē ir pieejams arī lejupielāmes fails) vai sazināties ar Jūsu valstī apliecināto Yamaha pārstāvniecību. *EEZ: Eiropas Ekonomikas zona	Latviešu
Dėmesio: informacija dėl garantijos pirkėjams EEE* ir Šveicarijoje Jei reikia išsamesnės informacijos apie šį „Yamaha“ produktą (jo techninę priežiūrą visoje EEE* ir Šveicarijoje, apsilankykite mūsų svetainėje toliau nurodytu adresu (svetainėje yra spausdinamas failas) arba kreipkitės į „Yamaha“ atstovybę savo šalyje. *EEE — Europos ekonominė erdvė	Lietuvių kalba
Dôležité upozornenie: Informácie o záruke pre zákazníkov v EHP* a Švajčiarsku Podrobnejšie informácie o záruke týkajúce sa tohto produktu od spoločnosti Yamaha a garancijnom servise v EHP* a Švajčiarsku nájdete na webovej stránke uvedenej nižšie (na našej webovej stránke je k dispozícii súbor na tlač) alebo sa obráťte na zástupcu spoločnosti Yamaha vo svojej krajine. *EHP: Európsky hospodársky priestor	Slovenčina
Pomembno obvestilo: Informacije o garanciji za kupce v EGP* in Švici Za podrobnejše informacije o tem Yamaha izdelku ter garancijskem servisu v celotnem EGP in Švici, obiščite spletno mesto, ki je navedeno spodaj (natisljiva datoteka je na voljo na našem spletnem mestu), ali se obrnite na Yamahinega predstavnikva v svoji državi. *EGP: Evropski gospodarski prostor	Slovenščina
Важно съобщение: Информация за гаранцията за клиенти в ЕИПТ* и Швейцария За подробна информация за гаранцията за този продукт на Yamaha и гаранционното обслужване в маневренската зона на ЕИПТ* и Швейцария или посетете посочения по-долу уеб сайт (на нашия уеб сайт има файл за печат), или се свържете с представителния офис на Yamaha във вашата страна. *ЕИПТ: Европейско икономическо пространство	Български език
Notificare importantă: Informații despre garanție pentru clienții din SEE* și Elveția Pentru informații detaliate privind acest produs Yamaha și serviciul de garanție Pan-SEE* și Elveția, vizitați site-ul la adresa de mai jos (fișierul imprimabil este disponibil pe site-ul nostru) sau contactați biroul reprezentanței Yamaha din țara dumneavoastră. *SEE: Spațiul Economic European	Limba română

<http://europe.yamaha.com/warranty/>

For details of products, please contact your nearest Yamaha representative or the authorized distributor listed below.

NORTH AMERICA

CANADA

Yamaha Canada Music Ltd.
135 Milner Avenue, Scarborough, Ontario,
M1S 3R1, Canada
Tel: 416-298-1311

U.S.A.

Yamaha Corporation of America
6600 Orangethorpe Ave., Buena Park, Calif. 90620,
U.S.A.
Tel: 714-522-9011

CENTRAL & SOUTH AMERICA

MEXICO

Yamaha De México, S.A. de C.V.
Av. Insurgentes Sur 1647 "Prisma Insurgentes",
Col. San José Insurgentes, Del. Benito Juárez,
03900, México, D.F.
Tel: 55-5804-0600

BRAZIL

Yamaha Musical do Brasil Ltda.
Rua Joaquim Floriano, 913 - 4º andar, Itaim Bibi,
CEP 04534-013 Sao Paulo, SP. BRAZIL
Tel: 011-3704-1377

ARGENTINA

Yamaha Music Latin America, S.A.
Sucursal de Argentina
Olga Cossetini 1553, Piso 4 Norte
Madero Este-C1107CEK
Buenos Aires, Argentina
Tel: 011-4119-7000

PANAMA AND OTHER LATIN AMERICAN COUNTRIES/ CARIBBEAN COUNTRIES

Yamaha Music Latin America, S.A.
Torre Banco General, Piso 7, Urbanización Marbella,
Calle 47 y Aquilino de la Guardia,
Ciudad de Panamá, Panamá
Tel: +507-269-5311

EUROPE

THE UNITED KINGDOM/IRELAND

Yamaha Music Europe GmbH (UK)
Sherbourne Drive, Tilbrook, Milton Keynes,
MK7 8BL, England
Tel: 01908-366700

GERMANY

Yamaha Music Europe GmbH
Siemensstraße 22-34, 25462 Rellingen, Germany
Tel: 04101-3030

SWITZERLAND/LIECHTENSTEIN

Yamaha Music Europe GmbH
Branch Switzerland in Zürich
Seefeldstrasse 94, 8008 Zürich, Switzerland
Tel: 044-387-8080

AUSTRIA

Yamaha Music Europe GmbH Branch Austria
Schleiergasse 20, A-1100 Wien, Austria
Tel: 01-60203900

CZECH REPUBLIC/HUNGARY/ ROMANIA/SLOVAKIA/SLOVENIA

Yamaha Music Europe GmbH
Branch Austria (Central Eastern Europe Office)
Schleiergasse 20, A-1100 Wien, Austria
Tel: 01-602039025

POLAND/LITHUANIA/LATVIA/ESTONIA

Yamaha Music Europe GmbH
Branch Poland Office
ul. Wrotkowa 14 02-553 Warsaw, Poland
Tel: 022-500-2925

BULGARIA

Dinacord Bulgaria LTD.
Bul. Iskarsko Schose 7 Targowski Zentar Ewropa
1528 Sofia, Bulgaria
Tel: 02-978-20-25

MALTA

Olimpus Music Ltd.
The Emporium, Level 3, St. Louis Street Msida
MSD06
Tel: 02133-2144

THE NETHERLANDS/ BELGIUM/LUXEMBOURG

Yamaha Music Europe Branch Benelux
Clarissenhof 5-b, 4133 AB Vianen, The Netherlands
Tel: 0347-358 040

FRANCE

Yamaha Music Europe
7 rue Ambroise Croizat, Zone d'activités Pariest,
77183 Croissy-Beaubourg, France
Tel: 01-64-61-4000

ITALY

Yamaha Music Europe GmbH, Branch Italy
Viale Italia 88, 20020 Lainate (Milano), Italy
Tel: 02-935-771

SPAIN/PORTUGAL

**Yamaha Music Europe GmbH Ibérica, Sucursal
en España**
Ctra. de la Coruna km. 17, 200, 28230
Las Rozas (Madrid), Spain
Tel: 91-639-8888

GREECE

Philippos Nakas S.A. The Music House
147 Skiathou Street, 112-55 Athens, Greece
Tel: 01-228 2160

SWEDEN

**Yamaha Music Europe GmbH Germany filial
Scandinavia**
J. A. Wettergrens Gata 1, Box 30053
S-400 43 Göteborg, Sweden
Tel: 031 89 34 00

DENMARK

**Yamaha Music Europe GmbH, Tyskland - filial
Denmark**
Generatorvej 6A, DK-2730 Herlev, Denmark
Tel: 44 92 49 00

FINLAND

F-Musiikki Oy
Kluuvikatu 6, P.O. Box 260,
SF-00101 Helsinki, Finland
Tel: 09 618511

NORWAY

**Yamaha Music Europe GmbH Germany -
Norwegian Branch**
Grini Næringspark 1, N-1345 Østerås, Norway
Tel: 67 16 77 70

ICELAND

Skifan HF
Skifan 17 P.O. Box 8120, IS-128 Reykjavik, Iceland
Tel: 525 5000

RUSSIA

Yamaha Music (Russia)
Room 37, bld. 7, Kievskaya street, Moscow,
121059, Russia
Tel: 495 626 5005

OTHER EUROPEAN COUNTRIES

Yamaha Music Europe GmbH
Siemensstraße 22-34, 25462 Rellingen, Germany
Tel: +49-4101-3030

AFRICA

**Yamaha Corporation,
Asia-Pacific Sales & Marketing Group**
Nakazawa-cho 10-1, Naka-ku, Hamamatsu,
Japan 430-8650
Tel: +81-53-460-2313

MIDDLE EAST

TURKEY/CYPRUS

Yamaha Music Europe GmbH
Siemensstraße 22-34, 25462 Rellingen, Germany
Tel: 04101-3030

OTHER COUNTRIES

Yamaha Music Gulf FZE
LOB 16-513, P.O.Box 17328, Jubel Ali,
Dubai, United Arab Emirates
Tel: +971-4-881-5868

ASIA

THE PEOPLE'S REPUBLIC OF CHINA

Yamaha Music & Electronics (China) Co., Ltd.
2F, Yunhedasha, 1818 Xinzha-lu, Jingan-qu,
Shanghai, China
Tel: 021-6247-2211

HONG KONG

Tom Lee Music Co., Ltd.
11/F, Silvercord Tower 1, 30 Canton Road,
Tsimshatsui, Kowloon, Hong Kong
Tel: 2737-7688

INDIA

Yamaha Music India Pvt. Ltd.
Spazedge building, Ground Floor, Tower A, Sector
47, Gurgaon- Sohna Road, Gurgaon, Haryana, India
Tel: 0124-485-3300

INDONESIA

**PT. Yamaha Musik Indonesia (Distributor)
PT. Nusantik**
Gedung Yamaha Music Center, Jalan Jend. Gatot
Subroto Kav. 4, Jakarta 12930, Indonesia
Tel: 021-520-2577

KOREA

Yamaha Music Korea Ltd.
8F, 9F, Dongsung Bldg. 158-9 Samsung-Dong,
Kangnam-Gu, Seoul, Korea
Tel: 02-3467-3300

MALAYSIA

Yamaha Music (Malaysia) Sdn., Bhd.
Lot 8, Jalan Perbandaran, 47301 Kelana Jaya,
Petaling Jaya, Selangor, Malaysia
Tel: 03-78030900

PHILIPPINES

Yupangco Music Corporation
339 Gil J. Puyat Avenue, P.O. Box 885 MCPO,
Makati, Metro Manila, Philippines
Tel: 819-7551

SINGAPORE

Yamaha Music (Asia) PRIVATE LIMITED
Blk 202 Hougang Street 21, #02-00,
Singapore 530202, Singapore
Tel: 6747-4374

TAIWAN

Yamaha KHS Music Co., Ltd.
3F, #6, Sec.2, Nan Jing E. Rd. Taipei.
Taiwan 104, R.O.C.
Tel: 02-2511-8688

THAILAND

Siam Music Yamaha Co., Ltd.
4, 6, 15 and 16th floor, Siam Motors Building,
891/1 Rama 1 Road, Wangmai,
Pathumwan, Bangkok 10330, Thailand
Tel: 02-215-2622

OTHER ASIAN COUNTRIES

**Yamaha Corporation,
Asia-Pacific Sales & Marketing Group**
Nakazawa-cho 10-1, Naka-ku, Hamamatsu,
Japan 430-8650
Tel: +81-53-460-2313

OCEANIA

AUSTRALIA

Yamaha Music Australia Pty. Ltd.
Level 1, 99 Queensbridge Street, Southbank,
Victoria 3006, Australia
Tel: 3-9693-5111

NEW ZEALAND

Music Works LTD
P.O. BOX 6246 Wellesley, Auckland 4680,
New Zealand
Tel: 9-634-0099

COUNTRIES AND TRUST TERRITORIES IN PACIFIC OCEAN

**Yamaha Corporation,
Asia-Pacific Sales & Marketing Group**
Nakazawa-cho 10-1, Naka-ku, Hamamatsu,
Japan 430-8650
Tel: +81-53-460-2313



Yamaha Global Site
<http://www.yamaha.com/>

Yamaha Downloads
<http://download.yamaha.com/>

U.R.G., Digital Musical Instruments Division
© 2013 Yamaha Corporation

302POZC*.*-01A0
Printed in Indonesia

ZF49080



ZF49080