



Clavinova[®]

CLP-825

Owner's Manual

Mode d'emploi

Before using the instrument, be sure to read "PRECAUTIONS" on pages 3–4.
For information on assembling the instrument, refer to the instructions on page 34.

Avant d'utiliser l'instrument, lisez attentivement la section « PRÉCAUTIONS D'USAGE »
aux pages 3 et 4.
Pour plus d'informations sur l'assemblage de l'instrument, reportez-vous aux instructions
figurant en page 34.

English

Français

EN

FR

FCC INFORMATION (U.S.A.)

1. IMPORTANT NOTICE: DO NOT MODIFY THIS UNIT!

This product, when installed as indicated in the instructions contained in this manual, meets FCC requirements. Modifications not expressly approved by Yamaha may void your authority, granted by the FCC, to use the product.

2. IMPORTANT: When connecting this product to accessories and/or another product use only high quality shielded cables. Cable/s supplied with this product MUST be used. Follow all installation instructions. Failure to follow instructions could void your FCC authorization to use this product in the USA.

3. NOTE: This product has been tested and found to comply with the requirements listed in FCC Regulations, Part 15 for Class "B" digital devices. Compliance with these requirements provides a reasonable level of assurance that your use of this product in a residential environment will not result in harmful interference with other electronic devices. This equipment generates/uses radio frequencies and, if not installed and used according to the instructions found in the users manual, may cause interference harmful to the operation of other electronic devices. Com-

pliance with FCC regulations does not guarantee that interference will not occur in all installations. If this product is found to be the source of interference, which can be determined by turning the unit "OFF" and "ON", please try to eliminate the problem by using one of the following measures:

- Relocate either this product or the device that is being affected by the interference.
- Utilize power outlets that are on different branch (circuit breaker or fuse) circuits or install AC line filter/s.
- In the case of radio or TV interference, relocate/reorient the antenna. If the antenna lead-in is 300 ohm ribbon lead, change the lead-in to co-axial type cable.

If these corrective measures do not produce satisfactory results, please contact the local retailer authorized to distribute this type of product. If you cannot locate the appropriate retailer, please contact Yamaha Corporation of America, 6600 Orangethorpe Avenue, Buena Park, CA90620, USA.

The above statements apply ONLY to those products distributed by Yamaha Corporation of America or its subsidiaries.

(529-M04 FCC class B YCA 02)

COMPLIANCE INFORMATION STATEMENT (Supplier's declaration of conformity procedure)

Responsible Party: Yamaha Corporation of America
Address: 6600 Orangethorpe Ave. Buena Park, CA 90620
Telephone: 714-522-9011
Type of Equipment: Digital Piano
Model Name: CLP-825

This device complies with Part 15 of the FCC Rules.

Operation is subject to the following two conditions:

- 1) this device may not cause harmful interference, and
- 2) this device must accept any interference received including interference that may cause undesired operation.

(529-M02 FCC sdoc YCA 02)

The model number, serial number, power requirements, etc., may be found on or near the name plate, which is at the bottom of the unit. You should note this serial number in the space provided below and retain this manual as a permanent record of your purchase to aid identification in the event of theft.

Model No.

Serial No.

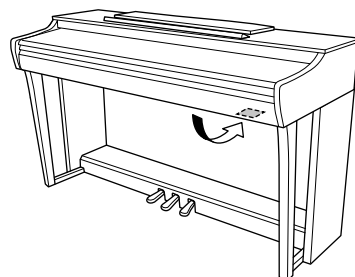

(1003-M06 plate bottom en 01) The name plate is located on the bottom of the unit.

PRECAUTIONS

PLEASE READ CAREFULLY BEFORE PROCEEDING

Especially in the case of children, a guardian should provide guidance on how to properly use and handle the product before actual use. Please keep this manual in a safe and handy place for future reference.



WARNING

Always follow the basic precautions listed below to avoid the possibility of serious injury or even death from electrical shock, short-circuiting, damages, fire or other hazards. These precautions include, but are not limited to, the following:

Power supply

- Do not place the power cord near heat sources such as heaters or radiators. Also, do not excessively bend or otherwise damage the cord, or place heavy objects on it.
- Do not touch the product or the power plug during an electrical storm.
- Use only the correct voltage specified for the product. The required voltage is printed on the name plate of the product.
- Use only the supplied or the specified AC adaptor (page 38)/power cord. Do not use the AC adaptor/power cord for other devices.
- Check the power plug periodically and remove any dirt or dust which may have accumulated on it.
- Insert the power plug firmly all the way into the AC outlet. Using the product when it is not plugged in sufficiently can cause dust to accumulate on the plug, possibly resulting in fire or skin burns.
- When setting up the product, make sure that the AC outlet you are using is easily accessible. If some trouble or malfunction occurs, immediately turn off the power switch and disconnect the plug from the outlet. Even when the power switch is turned off, as long as the power cord is not unplugged from the wall AC outlet, the product will not be disconnected from the power source.
- Do not connect the product to an electrical outlet using a multi-plug outlet extender. Doing so can result in lower sound quality, or possibly cause overheating in the outlet.
- When disconnecting the power plug, always hold the plug itself and not the cord. Pulling by the cord can damage it and cause electric shocks or a fire.
- If not using the product for long periods of time, be sure to pull the power plug from the AC outlet.

Do not disassemble

- This product contains no user-serviceable parts. Do not attempt to disassemble the internal parts or modify them in any way.

Water warning

- Do not expose the product to rain, use it near water or in damp or wet conditions, or place on it any containers (such as vases, bottles or glasses) containing liquids which might spill into any openings or places where water may drop. A liquid such as water getting into the product may cause a fire, electric shocks, or malfunctions.
- Use the AC adaptor indoors only. Do not use in any wet environments.
- Never insert or remove a power plug with wet hands.

Fire warning

- Do not place any burning items or open flames near the product, since they may cause a fire.

Wireless unit

- Radio waves from this product may affect electro-medical devices, such as a heart pacemaker implant or defibrillator implant.
 - Do not use the product near medical devices or inside medical facilities. Radio waves from this product may affect electro-medical devices.
 - Do not use the product within 15 cm (6 in.) of persons with a heart pacemaker implant or a defibrillator implant.

Using the bench (if included)

- Do not place the bench in an unstable position where it might accidentally fall over.
- Do not play carelessly with or stand on the bench. Using it as a tool or stepladder or for any other purpose might result in accident or injury.
- Only one person should sit on the bench at a time, in order to prevent the possibility of accident or injury.
- If the bench screws become loose due to extensive long-term use, tighten them periodically using the specified tool in order to prevent the possibility of accident or injury.
- Keep special watch over any small children so that they don't fall off the rear of the bench. Since the bench does not have a backrest, unsupervised use may result in accident or injury.

If you notice any abnormality

- If any of the following problems occur, immediately turn off the power switch and disconnect the power plug from the outlet. Finally have the device inspected by Yamaha service personnel.
 - The power cord or plug becomes frayed or damaged.
 - Unusual smells or smoke are emitted.
 - Some object, or water has been dropped into the product.
 - There is a sudden loss of sound during use of the product.
 - Cracks or other visible damage appear on the product.

CAUTION

Always follow the basic precautions listed below to avoid the possibility of physical injury to you or others, or damage to the product or other property. These precautions include, but are not limited to, the following:

Assembly

- Assemble the product in the proper sequence by following the assembly instructions in this manual. Also, make sure to tighten the screws or bolts regularly. Failure to do so might result in damage to the product or even injury.

Location

- Do not place the product in an unstable position or a location with excessive vibration, where it might accidentally fall over and cause injury.
- Do not go near the product during an earthquake. Strong shaking during an earthquake could cause the product to move or tip over, resulting in damage to the product or its parts, and possibly causing injury.
- When transporting or moving the product, always use two or more people. Attempting to lift the product by yourself may result in injuries, such as back injuries, or cause the product to be dropped and broken, which could lead to other injuries.
- Before moving the product, remove all connected cables, to prevent damage to the cables or injury to anyone who might trip over them.

Connections

- Before connecting the product to other devices, turn off the power for all devices. Before turning the power on or off for all devices, set all volume levels to minimum.
- Be sure to set the volumes of all devices at their minimum levels and gradually raise the volume controls while playing the product to set the desired listening level.

Handling

- Do not insert your finger or hand in any gaps on the key cover or product. Also take care that the key cover does not pinch your finger.
- Do not insert foreign materials such as metal or paper into any openings or gaps of the product. Failure to observe this may cause a fire, electric shocks, or malfunctions.
- Do not rest your weight on, or place heavy objects on the product, and do not use excessive force on the buttons, switches or connectors.
- Keep small parts out of the reach of infants. Your children may accidentally swallow them.
- Do not use the product or headphones for a long period of time at a high or uncomfortable volume level, since this can cause permanent hearing loss. If you experience any hearing loss or ringing in the ears, consult a physician.
- Remove the power plug from the AC outlet before cleaning the unit. Failure to observe this may cause electric shocks.

Yamaha cannot be held responsible for damage caused by improper use or modifications to the product, or data that is lost or destroyed.

Always turn the power off when the instrument is not in use.

Even when the [⏻] (Standby/On) switch is in standby status (power lamp is off), electricity is still flowing to the instrument at the minimum level.

When you are not using the instrument for a long time, make sure you unplug the power cord from the wall AC outlet.

(DMI-11)

CAUTION

When moving the instrument, always hold the bottom of the main unit. Do not hold the key cover or top portion. Improper handling can result in damage to the instrument or personal injury.

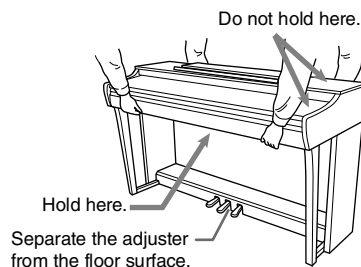

Transporting

If you move to another location, you can transport the instrument along with other belongings. You can move the unit as it is (assembled), or you can disassemble the unit down to the condition it was in when you first took it out of the box. Transport the keyboard horizontally. Do not lean it up against a wall or stand it up on its side. Do not subject the instrument to excessive vibration or shock. When transporting the assembled instrument, make sure all screws are properly tightened and have not been loosened by moving the instrument.

NOTICE

To avoid the possibility of malfunction/ damage to the product, damage to data, or damage to other property, follow the notices below.

■ Handling

- Do not use this product in the vicinity of a TV, radio, stereo equipment, mobile phone, or other electric devices. Otherwise, this product, or the other device may generate noise.
- When you use the product along with an app on your smart device, such as a smartphone or tablet, we recommend that you enable “Airplane Mode” on the device to avoid noise caused by communication. When turning on airplane mode, Wi-Fi or **Bluetooth**® settings may be turned off. Make sure that the setting is turned on before use.
- Do not expose the product to excessive dust or vibrations, or extreme cold or heat (such as in direct sunlight, near a heater, or in a car during the day) to prevent the possibility of disfiguration, damage to the internal components or unstable operation. (Verified operating temperature range: 5°–40°C, or 41°–104°F.)
- Do not place vinyl, plastic or rubber objects on the product, since this might discolor the product.
- In the case of a model with a polished finish, bumping the surface of the product with metal, porcelain, or other hard objects can cause the finish to crack or peel. Use caution.

■ Maintenance

- When cleaning the product, use a soft and dry (or slightly damp) cloth. Do not use paint thinners, solvents, alcohol, cleaning fluids, or chemical-impregnated wiping cloths.
- In the case of a model with a polished finish, gently remove dust and dirt with a soft cloth. Do not wipe too hard since small particles of dirt can scratch the instrument's finish.
- During extreme changes in temperature or humidity, condensation may occur and water may collect on the surface of the product. If water is left, the wooden parts may absorb the water and be damaged. Make sure to wipe any water off immediately with a soft cloth.

■ Saving data

- Some of the data of this product (page 31) are retained when the power is turned off. However, the saved data may be lost due to some failure, an operational mistake, etc.

Information

■ About copyrights

- The copyright of the “content”^{*1} installed in this product belongs to Yamaha Corporation or its copyright holder. Except as permitted by copyright laws and other relevant laws, such as copying for personal use, it is prohibited to “reproduce or divert”^{*2} without the permission of the copyright holder. When using the content, consult with a copyright expert.

If you create music or perform with the contents through the original use of the product, and then record and distribute them, the permission of Yamaha Corporation is not required regardless of whether the distribution method is paid or free of charge.

*1: The word “content” includes a computer program, audio data, Accompaniment Style data, MIDI data, waveform data, voice recording data, music score, and score data, etc.

*2: The phrase “reproduce or divert” includes taking out the content itself in this product, or recording and distributing it without changes in a similar manner.

■ About functions/data bundled with the product

- Some of the preset Songs have been edited for length or arrangement, and may not be exactly the same as the original.

■ About open source software

- The firmware of this product contains open source software. For copyright information and terms of use for each open source software, access the Yamaha website below:
Yamaha Downloads: <https://download.yamaha.com/>

■ About this manual

- The illustrations as shown in this manual are for instructional purposes only.
- Windows is a registered trademark of Microsoft® Corporation in the United States and other countries.
- The **Bluetooth**® word mark and logos are registered trademarks owned by Bluetooth SIG, Inc. and any use of such marks by Yamaha Corporation is under license.



- The company names and product names in this manual are the trademarks or registered trademarks of their respective companies.

■ Tuning

- Unlike an acoustic piano, this instrument does not need to be tuned by an expert (although the pitch can be user-adjusted to match other instruments). This is because the pitch of digital instruments is always maintained perfectly.

■ About disposal

- When disposing of this product, please contact the appropriate local authorities.

Table of Contents

PRECAUTIONS	3
About the Manuals	7
Included Accessories.....	7
Panel Controls and Terminals	8

Basic Operations

Setting Up.....	9
Key Cover.....	9
Music Rest.....	9
Turning the Power On	10
Auto Power Off Function	10
Volume Limiter Function.....	11
Using Headphones.....	11
Playing the Piano.....	13
Using the Pedals	13
Turning the VRM Effect On/Off	14
Intelligent Acoustic Control (IAC).....	14
Grand Expression Modeling	15
Turning the Operation Confirmation Sounds On/Off	15
Changing the Touch Sensitivity	15
Using the Metronome	16

Advanced Operations

Playing Various Musical Instrument Sounds (Voices)	17
Selecting a Voice.....	17
Listening to the Demo Songs	18
Adding Variations to the Sound (Reverb).....	19
Transposing the Pitch in Semitones.....	20
Fine-tuning the Pitch	20
Layering Two Voices (Dual mode)	21
Playing Duo	22
Song Playback and Practice.....	23
Listening to Preset Songs	23
Practicing a One-Hand Part	24
Playing Back Immediately from the First Note (Quick Play).....	24

Recording Your Performance	25
Recording Your Performance	25
Changing the Initial Settings of the Recorded Song	26
Deleting Recorded Data	26

Using with a Smart Device or a Computer

27	
Playback/Recording of Audio Data (USB Audio Interface).....	27
Listening to Audio via Bluetooth on this Instrument (Bluetooth Audio)	28
Using the convenient Smart Pianist app.....	29

Backing up Data and Initializing the Settings

31	
Data Maintained When Power is Turned Off	31
Initializing the Settings.....	31
Confirming the firmware version of this instrument	31

Appendix

Troubleshooting	32
Glossary of Terms.....	33
Keyboard Stand Assembly.....	34
Specifications	37
Index.....	39
Song List.....	40
Quick Operation Guide	at the end

Thank you for choosing this Yamaha digital piano.

This instrument provides exceptionally high-quality sound and expressive control for your playing enjoyment. In order to make the most of the performance potential and features of the instrument, please read the manuals thoroughly, and keep them in a handy place for later reference.

About the Manuals

This instrument has the following documents and instructional materials.



Supplied with the instrument

- **Owner's Manual (this book)**

Explains the basic operations and functions of this instrument. Please read this manual first.



Available on the website

- **Quick Operation Guide**

Shows in chart form the functions assigned to the buttons and the keyboard for quick understanding.



<https://manual.yamaha.com/mi/kb-ekb/clp825/>

- **MIDI Reference**

Contains the MIDI Data Format and MIDI Implementation chart, as well as descriptions on MIDI functions such as MIDI channel and Local Control settings.

- **Smart Pianist User Guide**

Explains how to set up and use the smart device app "Smart Pianist" (page 29) for controlling this instrument.



To obtain these manuals, access the website below:

Yamaha Downloads

<https://download.yamaha.com/>

Included Accessories

- Owner's Manual (this book)
- "50 Classical Music Masterpieces" (music book)
- Online Member Product Registration
- Bench*
- Power cord*, AC adaptor*

* May not be included depending on your area. Check with your Yamaha dealer.

Panel Controls and Terminals

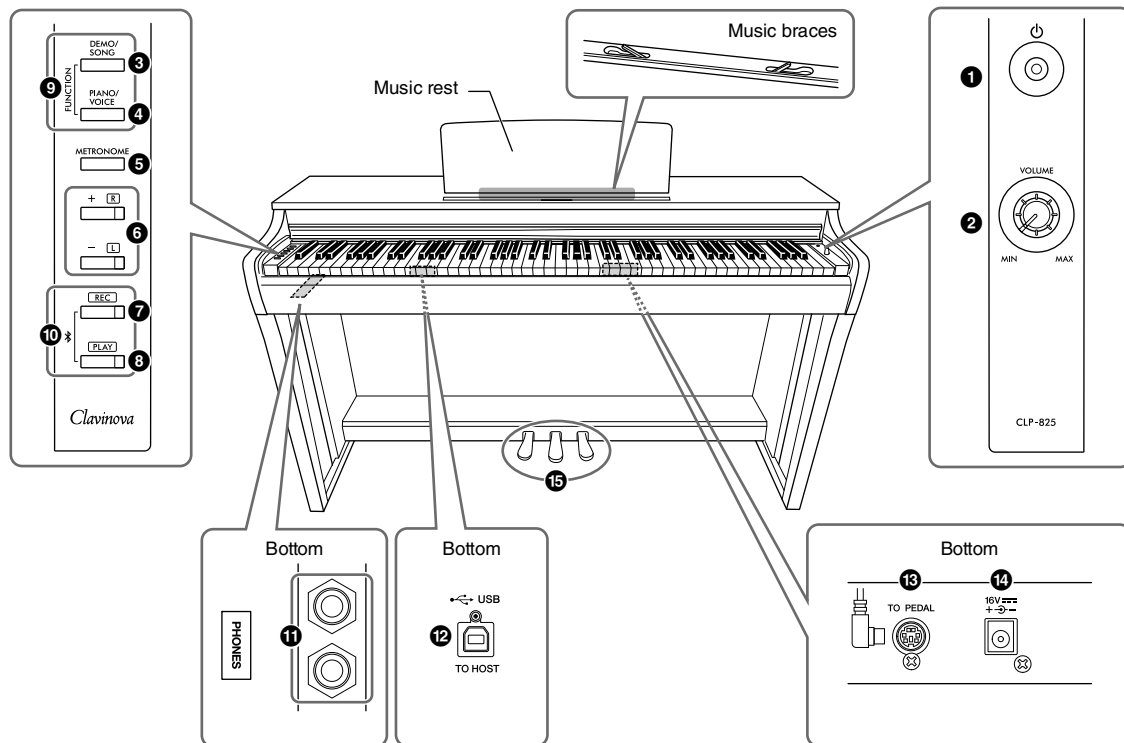

- 1 [⏻] (Standby/On) switch..... page 10**
For turning the power on or setting to standby.
- 2 [VOLUME] knob..... page 10**
For adjusting the volume of the entire sound.
Turning it to the right increases the volume, and turning it to the left decreases the volume.
- 3 [DEMO/SONG] button pages 18, 23**
For playing the Demo Songs and the Preset Songs.
- 4 [PIANO/VOICE] button ... pages 17, 19, 21**
For selecting a single Voice, two Voices for layering or a Reverb Type.
- 5 [METRONOME] button page 16**
For starting or stopping the metronome.
- 6 [+R], [-L] buttons pages 16, 17, 23, 24**
 - These are for increase or decrease Song numbers, tempo values, etc.
 - During Song playback, turning on/off the right-hand and left-hand Parts individually.
- 7 [REC] button page 25**
For recording your keyboard performance.
- 8 [PLAY] button..... page 25**
For playing back the recorded performance.

- 9 [FUNCTION]pages 10, 20**
Simultaneously holding both [DEMO/SONG] and [PIANO/VOICE] and pressing a specified key allows you to change various settings, including Auto Power off function, Transpose parameters, etc.
- 10 Bluetooth..... page 28**
For connecting to a Bluetooth-equipped device such as a smartphone.
* Bluetooth function may not be available depending on the country in which you purchased the product (page 28).
- 11 [PHONES] jackspage 11**
For connecting a set of standard stereo headphones.
- 12 [USB TO HOST] terminal..... page 27**
For connecting to a computer or a smart device such as a smartphone or tablet.
- 13 [TO PEDAL] jack page 36**
For connecting the pedal cord of the pre-installed pedal or the separately sold FC35 pedal unit.
- 14 DC IN jack.....page 10**
For connecting the AC adaptor.
- 15 Pedalspage 13**
For controlling expression and sustain, just as on an acoustic piano.

Setting Up

Key Cover

To open the key cover:

Lift the cover slightly, then push and slide it to the end.

To close the key cover:

Slide the cover toward you and gently lower the cover over the keys.

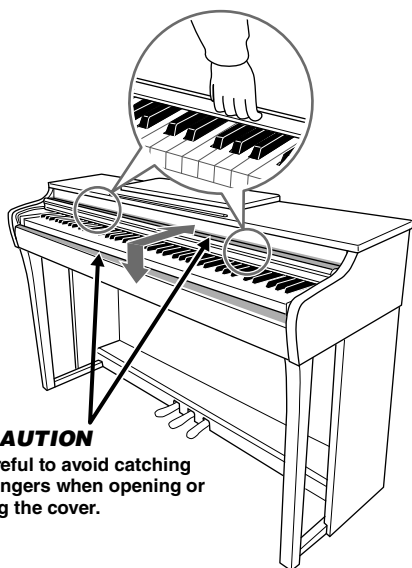

CAUTION
Be careful to avoid catching your fingers when opening or closing the cover.

CAUTION

- Hold the cover with both hands when opening or closing it. Do not release it until it is fully opened or closed. Be careful to avoid catching fingers (yours or others, especially children's) between the cover and main unit.
- Do not place objects, such as a piece of metal or paper, on top of the key cover. Small objects placed on the key cover may fall inside the unit when the cover is opened and may be nearly impossible to remove. This could cause electric shock, short circuit, fire or other serious damage to the instrument.

Music Rest

To raise the music rest:

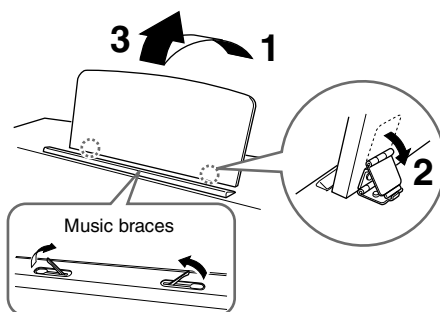

Music braces allow you to hold the pages of music books in place.

CAUTION

Do not try to use the music rest in a half-raised position. When lowering the music rest, do not release your hands from the music rest until it is all the way down.

To lower the music rest:

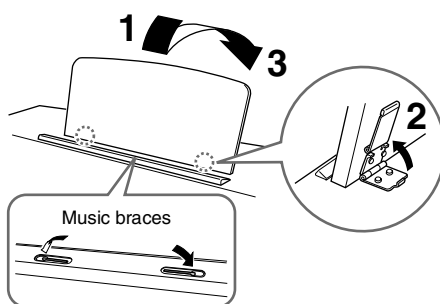

Close the Music braces if they are open, and then lower the music rest by following the instructions below.

Turning the Power On

1. Connect the plugs of the AC adaptor in the order shown in the illustration.

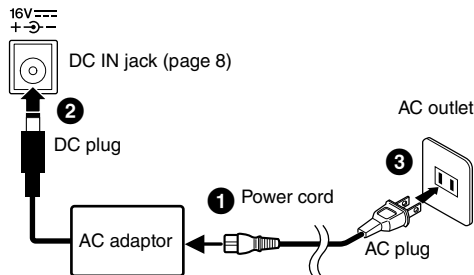

The shape of the plug and outlet differ depending on the locale.

WARNING

- Use the specified adaptor (page 38) only. The use of other adaptors may result in irreparable damage to both the adaptor and the instrument.
- When setting up the product, make sure that the AC outlet you are using is easily accessible. If some trouble or malfunction occurs, immediately turn the power off and disconnect the plug from the outlet.

NOTE

Follow this procedure in reverse order when disconnecting the AC adaptor.

2. Turn down the [VOLUME] knob to “MIN.”

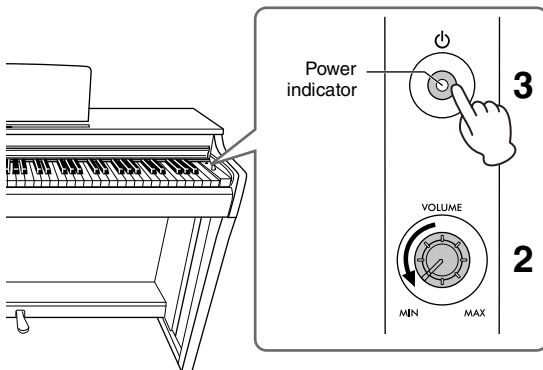

3. Press the [⏻] (Standby/On) switch to turn the power on.

The power indicator on the button lights up to indicate the power is on.

To adjust the volume of the entire keyboard sound, use the [VOLUME] knob while playing the keyboard.

When you're ready to turn the power to standby, press the [⏻] (Standby/On) switch again for a second. The power indicator turns off.

WARNING

Even when the [⏻] (Standby/On) switch is in the standby status, electricity is still flowing to the instrument at a minimum level. When not using the instrument for an extended period of time, be sure to unplug the power cord from the wall AC outlet.

CAUTION

Do not use this instrument at a high volume level for a long period of time, to avoid damaging your hearing.

NOTICE

Press only the [⏻] (Standby/On) switch when turning the power on. Any other operations, such as pressing the keys, buttons or pedals may cause the instrument to malfunction.

Auto Power Off Function

To prevent unnecessary power consumption, this instrument features an Auto Power Off function that automatically turns the power off if the instrument is not operated for approximately 15 minutes.

While holding down [DEMO/SONG] and [PIANO/VOICE] simultaneously, press the A#0 key to enable the Auto Power Off function or the A0 key to disable it.

Default setting: Enabled

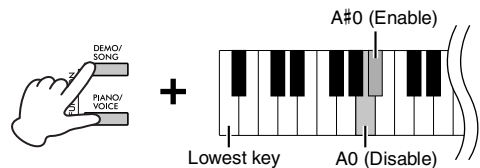

You can also disable the function when turning on the power to the instrument.

While holding down the A-1 key (the lowest key), press the [⏻] (Standby/On) switch to turn the instrument on. The [REC] indicator flashes three times, indicating the Auto Power Off function has been disabled.

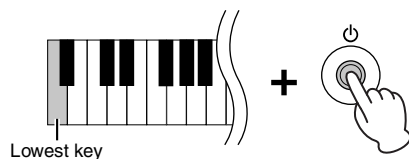

Volume Limiter Function

To prevent excessively loud volume, the Volume Limiter function can be used to limit the maximum volume. When the function is set to 20%, 50% or 80%, the volume will not increase beyond that point even if you turn the [VOLUME] knob to the right.

While simultaneously pressing [DEMO/SONG] and [PIANO/VOICE], press one of the keys F#6 (20%), G6 (50%), or G#6 (80%) as shown below to turn the function on, or press F6 to turn it off.

Default setting: Off

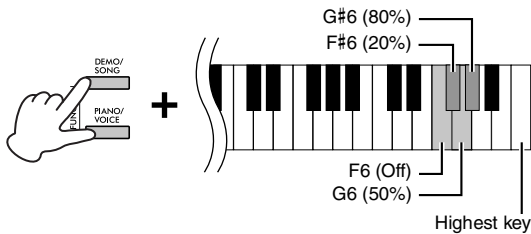

NOTICE

When turning this function off, if the [VOLUME] knob is turned to the right from center, loud noises may occur. Make sure that the knob is turned to the left from center, and then turn this function off.

Using Headphones

Since this instrument is equipped with two [PHONES] jacks, you can connect two sets of standard stereo headphones. If you are using only one set of headphones, insert a plug into either jack, which automatically shuts off the speakers according to the default setting.

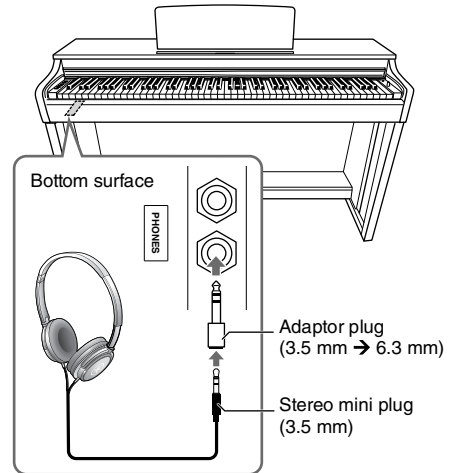

CAUTION

Do not use headphones at a high volume for an extended period of time; doing so may cause hearing loss.

NOTE

When a plug is connected to the [PHONES] jack, no sound will come out from the instrument's speakers. If you are using an adaptor plug, be sure to remove this as well when unplugging the headphones.

Using the headphone hanger

You can hang the headphones on this instrument. For instructions on installing the headphone hanger, refer to "Keyboard Stand Assembly" on page 34.

NOTICE

Do not hang anything other than the headphones on the hanger. Doing so may damage this instrument or the hanger.

Speaker On/Off setting

You can set whether the sound of this instrument is always output from its built-in speaker or not. While holding down [DEMO/SONG] and [PIANO/VOICE] simultaneously, press one of the F5–G5 key.

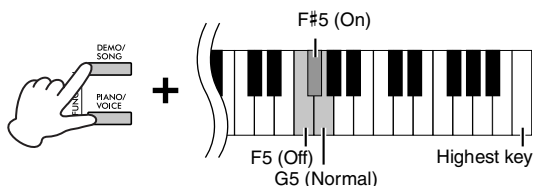

- **Off (F5):** The speaker will not sound.
- **On (F#5):** The speaker will always sound regardless of whether a set of headphones is connected or not.
- **Normal (G5):** The speaker will sound only if headphones are not connected. (This is the default setting.)

NOTE

When this is set to "On," Binaural Sampling and Stereophonic Optimizer at right are not effective.

Reproducing the Natural Sensation of Sound Distance—Binaural Sampling and Stereophonic Optimizer

This instrument features two advanced technologies that allow you to enjoy exceptionally realistic, natural sound, even when listening on headphones.

Binaural Sampling (“CFX Grand” Voice only)

Binaural Sampling is a method that uses two special microphones set at the ear position of a performer and records the sound from a piano as it would actually be heard. Listening to the sound with this effect through headphones gives the impression of being immersed in the sound, as if it was actually emanating from the piano. Moreover, you can enjoy the sound naturally for a long time without ear fatigue. When the default Voice “CFX Grand” (page 18) is selected, connecting the headphones automatically enables the binaural sampling sound.

Stereophonic Optimizer (Piano Voices other than “CFX Grand”)

Stereophonic Optimizer is an effect which reproduces the natural sound distance, like with the sound of Binaural Sampling, even though you are listening to it on headphones. When a piano Voice other than “CFX Grand” is selected, connecting the headphones automatically enables the Stereophonic Optimizer.

While holding down [PIANO/VOICE], press the F#3 key to turn the function on or the F3 key to turn the function off.

Default setting: On

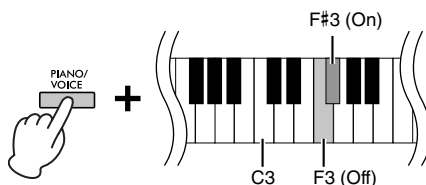

NOTE

The Stereophonic Optimizer affects only Piano Voices (page 17).

Playing the Piano

Using the Pedals

Damper Pedal (Right)

Pressing this pedal will sustain notes longer. Releasing this pedal immediately stops (damps) any sustained notes. This pedal also features a “half-pedal” function that creates partial sustain effects, depending on how far down you press the pedal.

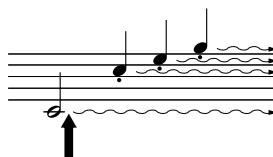

When you press the damper pedal here, this note and the notes you play before you release the pedal sustain longer.

Sostenuto Pedal (Center)

Pressing this pedal while holding the notes will sustain the pressed notes (as if the Damper Pedal had been pressed), but all subsequently played notes will not be sustained. This makes it possible to sustain a chord or single low note, for example, while the other notes are played “staccato.”

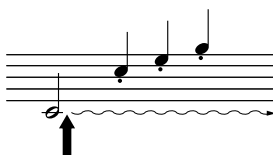

When you press the sostenuto pedal here while holding the note, the note will sustain as long as you hold the pedal.

Soft Pedal (Left)

Pressing this pedal will reduce the volume and slightly change the timbre of the notes. The notes played before this pedal is pressed are not affected.

NOTE

If the damper pedal doesn't work, make sure that the pedal cord is properly plugged into the main unit (page 36).

Half-pedal function

This function allows you to vary the sustain length depending on how far the pedal is pressed. The farther down you press the pedal, the more the sound sustains. For example, if you press the damper pedal and all notes you are playing sound a bit murky and loud with too much sustain, you can release the pedal half way or higher to decrease the sustain (murkiness).

NOTE

While the sostenuto pedal is held, the organ and strings Voices sound continuously without decay after the notes have been released.

NOTE

When Jazz Organ Voice (page 17) is selected, pressing the left pedal switches between fast/slow rotation of the rotary speaker. When the Vibraphone Voice (page 17) is selected, the left pedal switches Vibrato on and off.

[TO PEDAL] jack

Make sure to connect the plug of the pedal cord securely into the [TO PEDAL] jack in the proper direction. Otherwise, the pedal may not function properly. The FC35 Pedal Unit (sold separately) can also be connected to this terminal. You can substitute the FC35 for the pedals of the instrument, and use the pedals at a suitable height for you by placing the unit on a stand.

CAUTION

When placing the FC35 on a stand, make sure that the stand is sufficiently large, flat and stable to prevent the pedals from wobbling or falling when they are pressed.

NOTICE

Be careful to connect the plug in the proper direction. Connecting in the wrong direction can result in damage to the instrument.

NOTE

Make sure that power is off when connecting or disconnecting the plug of the pedal.

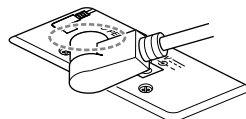

Insert the plug securely until the metal part of the plug disappears from view.

Turning the VRM Effect On/Off

VRM (Virtual Resonance Modeling) technology accurately recreates the unique resonance of an acoustic grand piano's soundboard and strings. When you select a CFX Grand, Bösendorfer or Pop Grand Voice (page 17), pressing the damper pedal activates the VRM effect. For details on VRM, see page 33.

While holding down [PIANO/VOICE], press the C#3 key to turn the function on or the C3 key to turn the function off.

Default setting: On

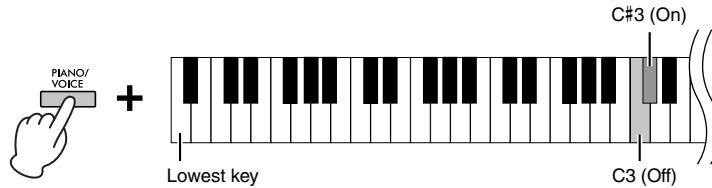

Intelligent Acoustic Control (IAC)

IAC is a function which automatically adjusts and controls the sound quality according to the overall volume of the instrument. IAC Control is effective only on the sound output of the instrument speakers or headphones. Even when the volume is low, this lets you hear both low sounds and high sounds clearly. Especially when using the headphones, the burden on the ears is reduced without raising the overall volume excessively.

To turn on/off IAC:

While holding down [DEMO/SONG] and [PIANO/VOICE] simultaneously, press the C#2 key to turn the function on or the C2 key to turn the function off.

Default setting: On

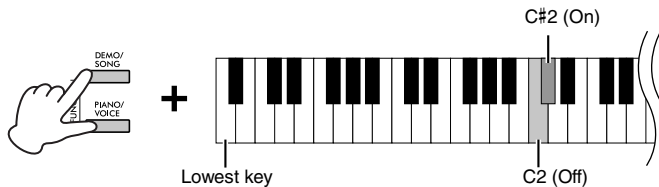

To adjust IAC Depth:

While holding down [DEMO/SONG] and [PIANO/VOICE] simultaneously, press the D2 key to decrease the value, or the E2 key to increase.

Setting range: -3 – +3

Default setting: 0

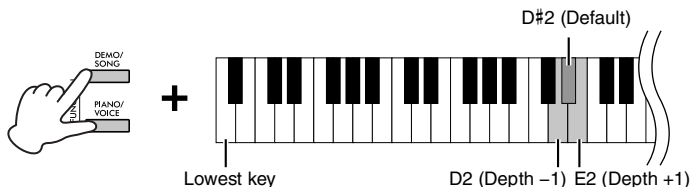

The higher the value, the more clearly that low and high sounds are heard at lower volume levels.

Grand Expression Modeling

When you select a CFX Grand, Bösendorfer or Pop Grand Voice (page 17), you can add Grand Expression Modeling effects, which simulate the physical sound transitions of an actual piano. For details on Grand Expression Modeling, see page 33.

While holding down [PIANO/VOICE], press the A3 or A#3 key to select the Grand Expression Modeling effect type.

- **Static (A3):** You can control extremely subtle nuances in the sound like on an actual acoustic piano by changing your playing strength or touch.
- **Dynamic (A#3):** The nuances are generally fixed even when you change your playing strength or touch.

Default setting: Dynamic

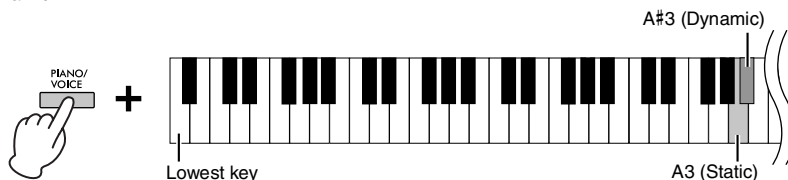

Turning the Operation Confirmation Sounds On/Off

When a setup is changed using a button and key combination, an operation sound (on, off, click, tempo value input) is sounded. This confirmation sound can be enabled (on) or disabled (off) as desired.

While holding down [DEMO/SONG] and [PIANO/VOICE] simultaneously, press the A#-1 key to turn the sounds on or the A-1 key to turn the sounds off.

Default setting: On

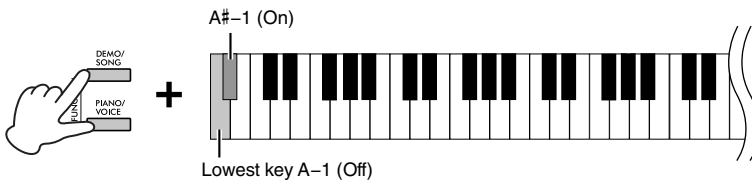

Changing the Touch Sensitivity

You can specify the Touch Sensitivity (how the sound responds to the way you play the keys).

While holding down [PIANO/VOICE], press one of the C6–D#6 keys.

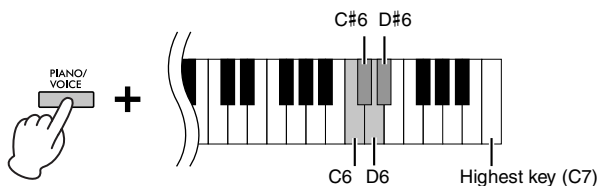

NOTE

This setting is disabled with some Voices, such as an organ sound.

Default setting:

Medium

Key	Touch Sensitivity	Description
C6	Soft	Produces relatively high volume even with light playing strength.
C#6	Medium	Standard Touch Sensitivity.
D6	Hard	Requires strong playing to produce high volume.
D#6	Fixed	The volume level does not change at all regardless of whether you play the keyboard soft or hard.

Using the Metronome

The metronome feature is convenient for practicing with an accurate tempo.

1. Press [METRONOME] to start the Metronome.

To adjust the Metronome tempo, use [+R] or [-L].

While the Metronome is playing, press [+R] to increase the tempo by 1 or [-L] to decrease it.

2. Press [METRONOME] to stop the Metronome.

Metronome setting

While holding down the [METRONOME], press one of the highlighted keys (shown below) or [+R]/[-L] to set the Metronome parameter.

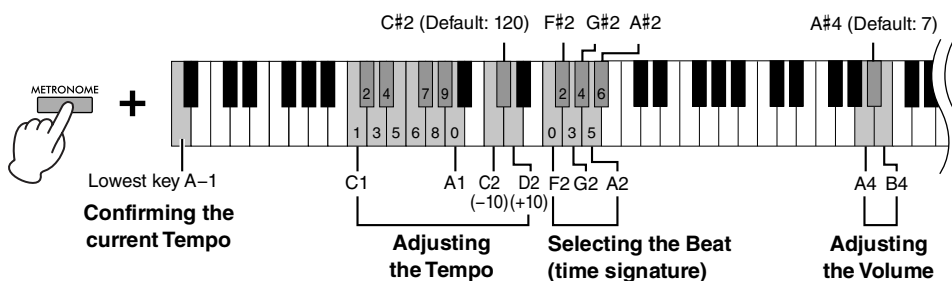

Voice confirmation of current Tempo value (in English)

While holding down [METRONOME], press the A-1 key (lowest key).

Adjusting the Tempo

The Metronome tempo can be set from 5 to 280 beats per minute.

- **To increase or decrease the value by 10:**

While holding down [METRONOME], press the D2 key to increase or the C2 key to decrease.

- **To specify a numeric value:**

While holding down [METRONOME], press the relevant C1–A1 keys one by one in order. Specifying three digits or releasing [METRONOME] after specifying one or two digits will enter the value.

- **Resetting the value to the default (120)**

While holding down [METRONOME], press [+R] and [-L] simultaneously, or press the C#2 key. While the metronome is playing, press [+R] and [-L] simultaneously.

Selecting the Beat (time signature)

While holding down [METRONOME], press one of the F2–A#2 keys.

The first beat is accented with a bell sound and the rest with clicks. Default setting is 0 (F2). In this setting, clicks sound in all beats.

Adjusting the Volume

While holding down [METRONOME], press the B4 key to increase the volume or the A4 key to decrease. To reset to the default setting, press the A#4 key while holding down [METRONOME].

NOTE

A numeric value is read out when a relevant key is pressed. If the entered value is outside the setting range, it will be ignored.

Key	Beat (time signature)
F2	0 (no accent)
F#2	2
G2	3
G#2	4
A2	5
A#2	6

Setting range:

1–10

Default setting:

7 (A#4)

Playing Various Musical Instrument Sounds (Voices)

Selecting a Voice

To select “CFX Grand”:

Simply press [PIANO/VOICE].

To select another Voice:

After pressing [PIANO/VOICE], press [+R] or [-L] to select the next or previous Voice.

To select a specific Voice:

While holding down [PIANO/VOICE], press one of the C1–A1 keys. For details on which Voice is assigned to each key, see the list below.

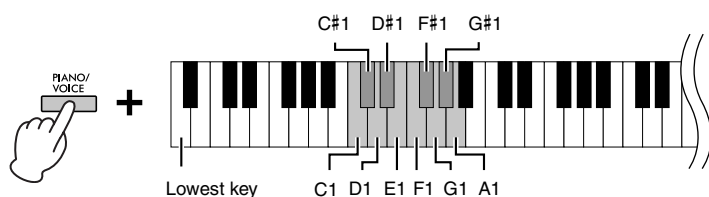

NOTE

To hear the characteristics of the Voices, play back the Demo Songs (page 18).

Voice List

Key	Voice Name	Voice description
C1	CFX Grand	Yamaha's CFX flagship concert grand piano sound with a wide dynamic range for maximum expressive control. Suitable for playing in any music genre and style.
	Binaural CFX Grand	Yamaha's CFX flagship concert grand piano sound sampled by Binaural Sampling, the method optimized for headphone use. Listening to this through headphones gives the impression of being immersed in the sound, as if it was actually emanating from the piano. This Voice is selected automatically when headphones are connected.
C#1	Bösendorfer	The famed sound of the Vienna-made Bösendorfer full concert grand piano. Its spacious sound evokes the size of the instrument, and is ideal for expressing tenderness in compositions.
D1	Pop Grand	Bright piano sound. Good for clear expression and “cutting through” other instruments in an ensemble.
D#1	Stage E. Piano	The sound of an electric piano using hammer-struck metallic “tines.” Soft tone when played lightly, and an aggressive tone when played hard.
E1	DX E. Piano	An electronic piano sound created by FM synthesis. Good for standard popular music.
F1	Harpsichord	The definitive instrument for baroque music. Since harpsichord uses plucked strings, there is no touch response. There is, however, a characteristic additional sound when the keys are released.
F#1	Vibraphone	Vibraphone played with relatively soft mallets. The tone becomes more metallic the harder you play.
G1	Pipe Organ	This is a typical pipe organ sound (8 feet + 4 feet + 2 feet). Good for sacred music from the Baroque period.
G#1	Jazz Organ	The sound of a “tonewheel” type electric organ. Often heard in jazz and rock music.
A1	Strings	Stereo-sampled, large-scale strings ensemble with realistic reverb. Try combining this Voice with piano in the Dual mode.

Listening to the Demo Songs

Special individual Demo Songs are provided for all of the instrument Voices.

1. Press [DEMO/SONG] to start playback.

The Demo Song for the current Voice starts. During playback, the [PLAY] lamp flashes at the current tempo.

Starting with the selected Song, the playback of the Demo Songs will continue.

After the last Demo Song, the sequence then returns to the first Demo Song and repeats until you stop it. To change to a specific Demo Song, simultaneously hold down [DEMO/SONG], and then press and hold one of the C1–A1 keys.

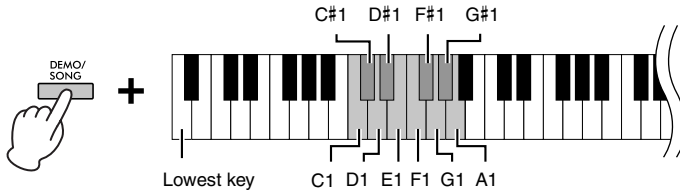

To play back the selected Demo Song repeatedly:

While holding down the [DEMO/SONG], press and hold one of the C1–A1 keys. The operation sound (page 15) sounds twice and the Demo Song can be played back repeatedly.

To change the Demo Song during playback:

Press [+R] or [-L] to change to the next or previous Demo Song.

If you change to the next or previous Demo Song during repeated playback, that Demo song will also play back repeatedly.

2. Press [DEMO/SONG] or [PLAY] to stop playback.

The [PLAY] lamp turns off.

Demo Song List

Key	Voice Name	Title	Composer
C1	CFX Grand	Ungarische rhapsodie "Preludio" E-Dur	F. Liszt
	Binaural CFX Grand		
C#1	Bösendorfer	Widmung S.566 R.253	F. Liszt / R. Schumann
D1	Pop Grand	Original	—
D#1	Stage E.Piano	Original	—
E1	DX E.Piano	Original	—
F1	Harpsichord	Concerto a cembalo obbligato, 2 violini, viola e continuo No.7, BWV 1058	J. S. Bach
F#1	Vibraphone	Original	—
G1	Pipe Organ	Herr Christ, der ein'ge Gottes-Sohn, BWV 601	J. S. Bach
G#1	Jazz Organ	Original	—
A1	Strings	Original	—

The Demo Songs excluding original Songs are short rearranged excerpts from the original compositions. The original Demo Songs are Yamaha originals (© Yamaha Corporation).

NOTE

If you want to change the playback tempo, see page 16.

Adding Variations to the Sound (Reverb)

This instrument features several Reverb Types that add extra depth and expression to the sound to create a realistic acoustic ambience. The appropriate Reverb Type and Depth are called up automatically when you select each of the Voices and Songs. This is why the Reverb Type need not be selected; however, you can change it if desired.

To select a Reverb Type:

While holding down [PIANO/VOICE], press one of the C2 – E2 keys.

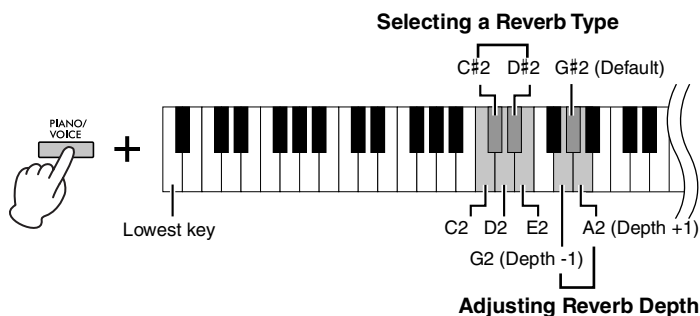

NOTE

In Dual Mode (page 21), an optimum reverb type for the combination of Voices is assigned automatically.

Reverb Type List

Key	Reverb Type	Description
C2	Recital Hall	Simulates the clear reverb sound you would hear in a medium-sized concert hall for piano recitals.
C#2	Concert Hall	Simulates the gorgeous reverb sound you would hear in a large concert hall for orchestral performances.
D2	Chamber	Suitable for playing chamber music; simulates the intimate reverb sound you would hear in a spacious room, such as for classical music recitals.
D#2	Club	Simulates the vivid reverb sound you would hear in a live music venue or a jazz club.
E2	Off	No effect is applied.

To adjust Reverb Depth:

The higher the value, the greater the depth, and the lower the value, the lesser the depth.

While holding down [PIANO/VOICE], press the G2 key to decrease the value by 1 or the A2 key to increase the value by 1.

While holding down [PIANO/VOICE], press the G#2 key to reset the Reverb Depth to the default setting, which is the most suitable value for the current Voice.

Setting range:

0 (no effect) – 20 (maximum depth)

Transposing the Pitch in Semitones

You can shift the pitch of the entire keyboard up or down in semitones in order to facilitate playing in difficult key signatures, or to easily match the pitch of the keyboard to the range of a singer or other instruments. For example, if “+5” is selected, playing key C produces pitch F, letting you play a song of F major as though it were in C major.

To transpose the pitch down:

While holding down [DEMO/SONG] and [PIANO/VOICE], press a key between F#2 (-6) and B2 (-1).

To transpose the pitch up:

While holding down [DEMO/SONG] and [PIANO/VOICE], press a key between C#3 (+1) and F#3 (+6).

To restore the normal pitch:

While holding down [DEMO/SONG] and [PIANO/VOICE], press the C3 key.

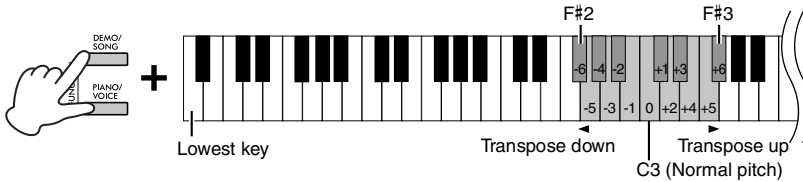

NOTE

The transposition setting affects not only the pitch of the keyboard but also the pitch of Song playback (page 23). The transposition setting of the Transposition for the Keyboard and the Song cannot be set independently.

Setting range:

-6 - 0 +6

Default setting:

0

Fine-tuning the Pitch

You can fine-tune the pitch of the entire instrument in about 0.2 Hz steps. This lets you accurately match the keyboard pitch to that of other instruments or ensembles.

To tune up (in about 0.2 Hz steps):

Press and hold down [DEMO/SONG] and [PIANO/VOICE] simultaneously, and press [+R].

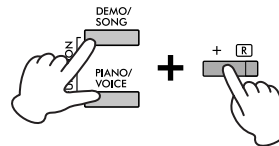

To tune down (in about 0.2 Hz steps):

Press and hold down [DEMO/SONG] and [PIANO/VOICE] simultaneously, and press [-L].

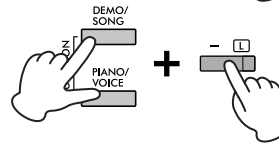

To set the pitch to 442.0 Hz:

Press and hold down [DEMO/SONG] and [PIANO/VOICE] simultaneously, and press the C#1 key.

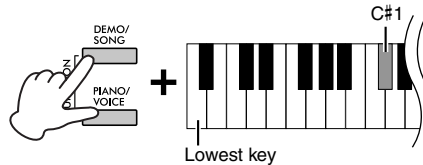

To restore default pitch (440.0 Hz):

While simultaneously holding down [DEMO/SONG] and [PIANO/VOICE], press [+R] and [-L] simultaneously. Alternately, you can press the C1 key while holding down [DEMO/SONG] and [PIANO/VOICE] simultaneously.

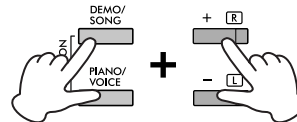

Hz (Hertz)

This unit of measurement refers to the frequency of a sound and represents the number of times a sound wave vibrates in a second.

Setting range:

414.8 - 466.8 Hz

Default setting:

A3 = 440.0 Hz

Layering Two Voices (Dual mode)

You can layer two Voices and play them simultaneously to create a more richly textured sound.

1. Engage the Dual mode.

While holding down [PIANO/VOICE], simultaneously hold down two keys between C1 and A1 to select the two desired Voices. For information on which Voices are assigned to the keys, refer to “Voice List” (page 17).

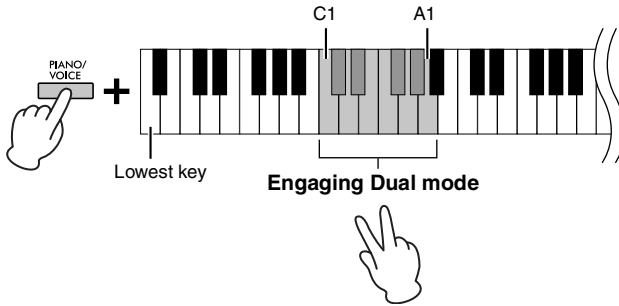

The Voice assigned to the lower key will be designated as Voice 1, and the Voice assigned to the higher key will be designated as Voice 2. You cannot assign the same Voice to both Voice 1 and Voice 2 simultaneously in Dual mode.

To shift the Octave for each Voice:

While holding down [PIANO/VOICE], press one of the keys F5–G5 or A5–B5 as shown in the illustration below. For example, pressing the B5 key twice while holding down [PIANO/VOICE] shifts Voice 1 up by two octaves. To restore the default setting, simultaneously hold down [PIANO/VOICE] and press the A#5 key for Voice 1 or the F#5 key for Voice 2.

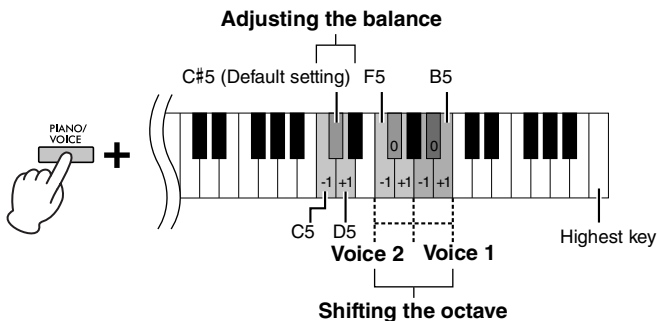

To adjust the Balance between two Voices:

While holding down [PIANO/VOICE], press the C5 key to decrease the value or the D5 key to increase. When the value is set to “0,” the volume levels of the two Voices reset to their respective default settings. Settings below “0” increase the volume of Voice 2, while settings above “0” increase the volume of Voice 1, in relation to the other.

2. To exit from Dual mode, press [PIANO/VOICE].

NOTE

The Dual and Duo modes (page 22) cannot be engaged at the same time.

Setting range:

-2 - 0 - +2

Setting range:

-6 - (Default Setting) - +6

Default setting:

Differs depending on the Voice combination.

Playing Duo

This function allows two different players to play the instrument, one on the left and the other on the right, over the same octave range.

1. While holding down [PIANO/VOICE], press [+R] and [-L] simultaneously to engage Duo.

The keyboard is divided into two sections, with the E3 key as the Split Point.

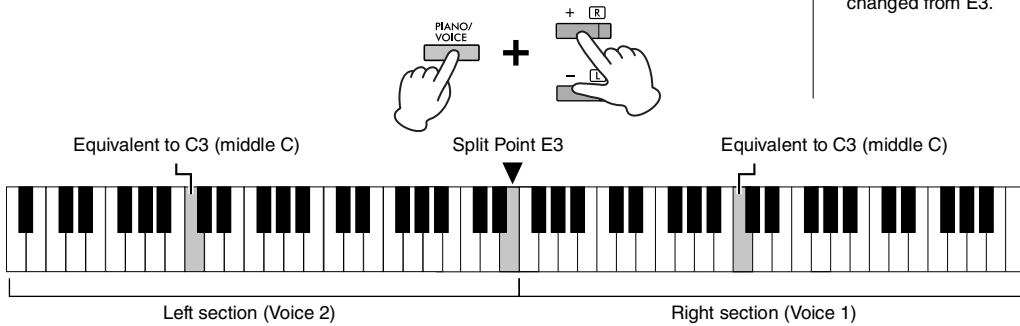

NOTE

- Different Voices cannot be assigned to the Right Voice and Left Voice.
- The Split Point cannot be changed from E3.

2. One person can play the left section of the keyboard while the other plays the right.

To shift the Octave for each section:

Same operation as in Dual (page 21).

In Duo, the left section is assigned to Voice 2, while the right section is assigned to Voice 1.

To adjust the volume balance between two keyboard sections:

Same operation as in Dual (page 21).

Settings below “0” increase the volume of Left Voice (Voice 2), while settings above “0” increase the volume of Right Voice, in relation to the other.

Pedal function in Duo

- Damper Pedal: Applies Sustain to the right section.
- Sostenuto Pedal: Applies Sustain to both sections.
- Soft Pedal: Applies Sustain to the left section.

To select the Duo Type:

You can set how the sound is emitted from the speakers.

- Separated: The sound of the left section is emitted from the left speaker, and the sound of the right section is emitted from the right speaker.
- Balanced: The sound of both parts are emitted from both speakers in a natural balance.

While holding down [PIANO/VOICE], press the A4 key or the A#4 key to change the setting.

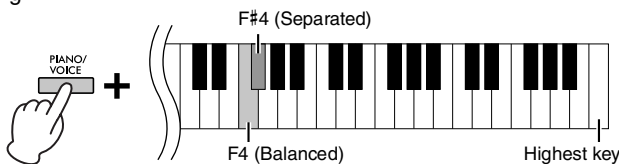

3. To exit from Duo, while holding down [PIANO/VOICE], press [+R] and [-L] simultaneously.

Setting range:

-2 - 0 - +2

Setting range:

-6 - 0 - +6

NOTE

The way the sound is output from the headphones is the same as the selected Duo Type.

NOTE

- If the keyboard is in Dual, engaging Duo will exit from Dual. Voice 1 is used as the Voice of the entire keyboard.
- In Duo, VRM is not effective. When the Type of Duo is set to “Separated,” Reverb and Stereophonic Optimizer are not effective.

Default Setting:

Separated

Song Playback and Practice

Listening to Preset Songs

In addition to the Demo Songs, Preset Songs (50 Classical Music Masterpieces [50 Classics] and Lesson Songs) are provided for your listening pleasure.

1. Find the Music book and Song number that you want to play back.

For the details on the Music book and Song number, refer to the Song List (page 40) or Quick Operation Guide (page 50.)

2. While holding down [DEMO/SONG], press one of the C0–G#0 keys to select a Music book.

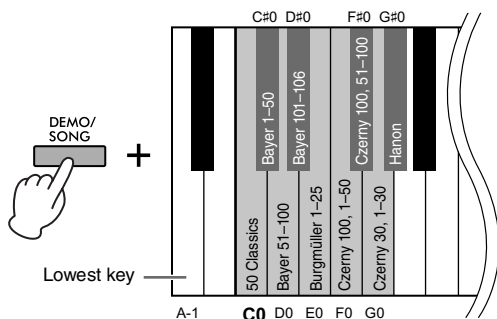

3. While holding down [DEMO/SONG], press one of the C2–C#6 keys to start playback.

The number of each piano Preset Song is assigned to the C2–C#6 keys.

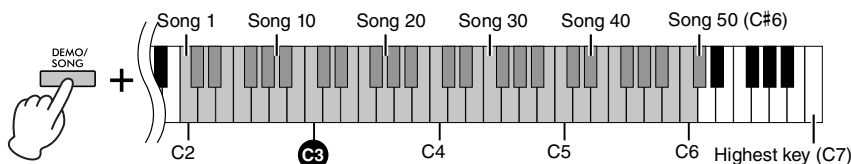

During playback, the [+R] and [-L] lamps light, and the [PLAY] lamp flashes at the current tempo. Playback of the Preset Songs continues in sequence, starting with the selected Song. After the last Preset Song, the sequence then returns to the first Preset Song and repeats until you stop it.

To play back the selected Song repeatedly:

While holding down the [DEMO/SONG], press and hold one of the C2–C#6 keys. The operation sound (page 15) sounds twice and the selected Song can be played back repeatedly.

To change the Preset Song during playback:

Press [+R] or [-L] to change to the next or previous Preset Song. If you change to the next or previous Preset Song during repeated playback, that Preset song will also play back repeatedly.

To change the tempo during playback:

While holding down [METRONOME], press [+R] or [-L] to increase or decrease the Tempo value by 1. Other instructions are the same as those of the Metronome Tempo (page 16).

Default Setting (Music book):

50 Classical Music Masterpieces (50 Classics)

NOTE

Even if you perform other operations after changing the Music book, the book will not be reset to the default setting, 50 Classical Music Masterpieces. It will be reset to the default setting when the power is turned off.

NOTE

- You can play the keyboard along with the playback of the Preset Song as well as change the Voice played from the keyboard.
- Depending on the selected Music book, there are some keys to which the Song are not applied. When pressing such keys, no Songs are played back.

To play back from the beginning of the Song

During playback, press [+R] and [-L] simultaneously to jump to the playback position at the beginning of the Song then continue playback at the last specified tempo.

4. Press [DEMO/SONG] or [PLAY] to stop playback.

The [PLAY], [+R] and [-L] lamps turn off.

Practicing a One-Hand Part

All the Songs except for the Demo (page 18) let you turn on or off the left-hand and right-hand Parts individually. By turning off [+R], for example, you can practice the right-hand Part while the left-hand Part is playing back, and vice versa.

1. Start playback of the Preset Songs (page 23; 50 Classical Music Masterpieces and Lesson Songs) or the User Song (page 25).

2. While holding down [PLAY], press [+R] or [-L] to turn the Part off.

Pressing the same button repeatedly while holding down [PLAY] toggles playback on and off.

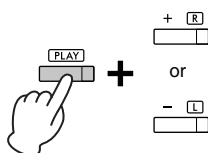

The lamp of the button lights when the corresponding Part is on.

NOTE

- Selecting another Song will reset the on/off status.
- For the details on the Parts of the duet Songs, refer to page 40.
- For the User Song, Parts can only be independently turned on or off when recording the right or left part independently (step 2, page 26).

3. Practice the Part which is turned off.

To change the Tempo:

If desired, you can change the tempo for your practice convenience. For details, refer to page 16.

4. Press [PLAY] to stop playback.

Playing Back Immediately from the First Note (Quick Play)

This Quick Play feature enables you to specify whether a Song should play back immediately from the very first note (On), or play back any silence or rests that exist before the first note (Off).

Default setting:

On

To turn on/off Quick Play:

While holding down [DEMO/SONG], press the A#-1 to turn the function on or A-1 key to turn the function off.

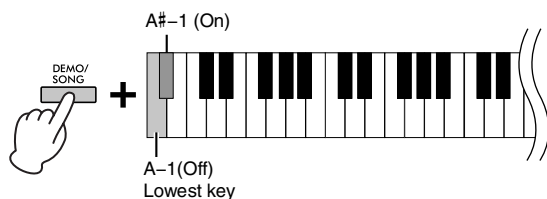

Recording Your Performance

Not only can you simply record your keyboard performance (Quick Recording), but you can record two parts (left-hand and right-hand) separately. The recorded data is saved to the instrument as a single User Song.

Recording Your Performance

1. Select the desired Voice and other parameters, such as beat (time signature), for recording.

For instructions on selecting a Voice, refer to page 17. If necessary, set other parameters, such as beat (time signature) and effects, in this step.

2. Engage the Record Ready mode.

Quick Recording

Press [REC] to engage the Record Ready mode. Your keyboard performance will be automatically recorded to the right-hand Part even if you play with both your right and left hands. Note that the already-recorded data of the right- and left-hand parts will be erased by Quick Recording.

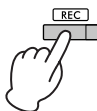

Recording to individual parts

While holding down [REC], press [+R] or [-L] to engage the Record Ready mode for the Part you want to record.

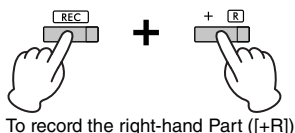

To record the right-hand Part ([+R])

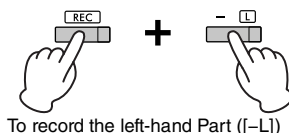

To record the left-hand Part ([-L])

If data has already been recorded to the other Part, the data in this Part will be played back while recording.

To turn the Part off or on, press the appropriate part button ([+R] or [-L]) while holding down [PLAY].

To exit from Record Ready mode:

Simply press [REC].

3. Play the keyboard or press [PLAY] to start recording.

The [REC] lamp lights up while the Recording Part lamp flashes at the current tempo.

4. Press either [REC] or [PLAY] to stop recording.

The [REC], [PLAY], [+R] and [-L] lamps flash, indicating that the recorded data is being stored. After the Save operation is completed, the lamps will turn off, indicating that the Record operation has been completed.

5. To hear the recorded Song, press [PLAY] to start playback.

Press [PLAY] again to stop playback.

To record to the other part

Repeat the steps above. In step 2, follow the instructions of "Recording individual parts."

NOTICE

Only one Song can be recorded to the instrument. Note that recording another Song will replace already-recorded data with the new data.

NOTE

- The "Smart Pianist" app (page 29) enables you to record your keyboard performance as MIDI/audio data and save it on your smart device.
- You can use the Metronome while recording; however, the Metronome sound will not be recorded.
- If the keyboard is in the Duo mode (page 22), the data will be recorded to each Part. The Part for recording cannot be specified.
- If the data capacity of the instrument approaches full when you engage Record Ready mode, the [REC] and [PLAY] lamps flash quickly for about three seconds.

NOTICE

Note that recording your performance to a part containing data will replace already-recorded data with the new data. If the [+R] or [-L] lamp (as well as [REC] and [PLAY]) flashes when engaging the Record Ready mode, this indicates that the part contains already-recorded data.

NOTICE

Never turn off the power while the recorded data is being stored (while the lamps are flashing). Otherwise, all recorded data will be lost.

Recording Capacity

This instrument can record up to 100 KB (approximately 11,000 notes).

Changing the Initial Settings of the Recorded Song

The settings of the following parameters can be changed after the Record operation is completed.

- For individual Parts: Voice, Volume balance (Dual), Reverb Depth
- For the entire Song: Tempo, Reverb Type

- 1. Make settings for the above parameters as desired.**
- 2. While holding down [REC], press the desired Part ([+R] or [-L]) to engage Record Ready mode.**

The [REC], [PLAY] and selected Part lamps flash.

In this status, do not press [PLAY] again or any key. Otherwise, the originally recorded performance data will be deleted.

- 3. While holding down [REC], press [PLAY] to exit from Record Ready mode.**

The [REC], [PLAY], [+R] and [-L] lamps flash. After the Save operation is completed, the lamps will turn off, indicating that the operation has been completed.

Confirm the setting by pressing [PLAY] to play the Song.

Deleting Recorded Data

To delete the entire Song:

- 1. While holding down [REC], press [DEMO/SONG].**
The [REC] and [PLAY] lamps flash alternately.
To cancel the operation, press [REC].
- 2. Press [PLAY] to delete the data of the entire Song.**
The [REC], [PLAY], [+R] and [-L] lamps flash.
After the operation is completed, all lamps turn off.

NOTE

If a User Song has not been recorded to the instrument, the [REC] and [PLAY] lamps flash quickly for about three seconds.

To delete a specific Part:

- 1. While holding down [REC], press [+R] or [-L] (depending on the Part you want to delete) to engage Record Ready mode.**
The [REC], [PLAY] and selected Part ([+R] or [-L]) lamps flash.
- 2. Press [PLAY] to start recording without playing the keyboard.**
The selected Part ([+R] or [-L]) lamp flashes.
- 3. Press [REC] or [PLAY] to stop recording.**
All data recorded for the selected Part will be deleted, and the lamp turns off.

Using with a Smart Device or a Computer

Connecting this instrument to a computer or a smart device allows you to transmit/receive performance data and Song data to/from the smart device or computer. You can connect the instrument to a computer or a smart device via a USB cable or Bluetooth.

NOTICE

Do not place any devices in an unstable position. Doing so may cause the device to fall and result in damage.

NOTE

For instructions on using MIDI, refer to "MIDI Reference" (page 7).

Playback/Recording of Audio Data (USB Audio Interface)

By connecting a smart device or a computer to the [USB TO HOST] terminal via a USB cable, digital audio data can be received/transmitted. You can listen to audio data played on the connected device through the instrument speaker, or you can record your performance on the instrument as audio data by using a music production software or app.

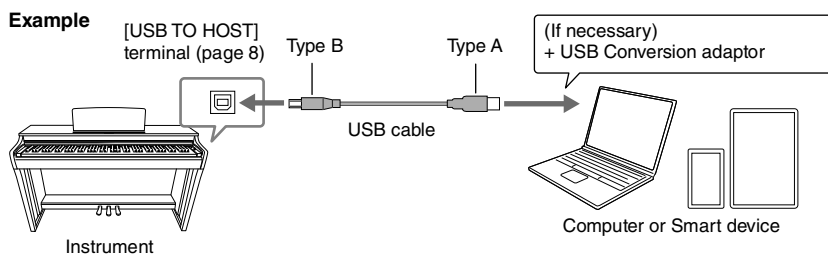

When transmitting or receiving audio signals by using a computer running Windows, if operation is unstable or delays occur, use the "Yamaha Steinberg USB Driver." On the website below, search for "Yamaha Steinberg USB Driver" and install it on the computer. For instructions on installing the driver, refer to the Installation Guide included with the download file.

<https://download.yamaha.com/>

NOTICE

If you are using a DAW (digital audio workstation) application with this instrument, set the Audio Loopback function to off (page 28). Otherwise, a loud sound may occur, depending on the settings of the computer.

NOTE

- Depending on the model or OS of the computer and smart device, noise may occur, or this function may not be available.
- Unexpected sounds may occur if you edit MIDI data related to the Grand Expression Modeling effect (page 33) on a computer.

Precautions when using the [USB TO HOST] terminal

When connecting a smart device or a computer to the [USB TO HOST] terminal, make sure to observe the following points to avoid freezing the smart device, computer or instrument, and corrupting or losing the data.

NOTICE

- Use a AB type USB cable of less than 3 meters. USB 3.0 cables cannot be used.
- Execute the following before turning the power to the instrument on/off or plugging/unplugging the USB cable to/from the [USB TO HOST] terminal.
 - Quit any open app on the smart device/computer.
 - Make sure that data is not being transmitted from the instrument. (Data is transmitted even when the notes on the keyboard are played or a Song is played back.)
- While the smart device/computer is connected to the instrument, you should wait for six seconds or more between these operations: (1) when turning the power of the instrument off then on again, or (2) when alternately connecting/disconnecting the USB cable.

If the smart device, computer or instrument freezes, restart the app or the computer/smart device, or turn the power to the instrument off then on again.

Turning Audio Loopback On/Off

You can set whether audio sound input from the [USB TO HOST] terminal is returned to the computer/smart device or not along with the performance played on the instrument.

While holding down [DEMO/SONG] and [PIANO/VOICE] simultaneously, press the C6 key to turn this parameter “Off” or the C#6 key to turn it “On.”

Default setting: On

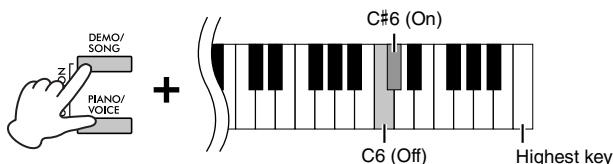

Listening to Audio via Bluetooth on this Instrument (Bluetooth Audio)

Before using the Bluetooth function, be sure to read “About Bluetooth” on page 29.

A Bluetooth-equipped audio player such as a smart device or a computer can be connected by using the Bluetooth Audio function. Audio playback on the connected device is output from the built-in speakers of this instrument.

Bluetooth capability

Depending on the country in which you purchased the product, the instrument may not have Bluetooth capability.

If the Bluetooth logo is printed on the control panel, this means that the product is equipped with Bluetooth functionality.

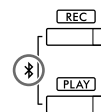

NOTE

- In order to use the Bluetooth function via wireless communication, the audio player must be equipped for transmitting audio data. For proper operation, the device must be compatible with A2DP (Advanced Audio Distribution Profile).
- Since this instrument cannot transmit audio data to external devices via Bluetooth, Bluetooth headphones or speakers cannot be connected.

To connect via Bluetooth, the Bluetooth function of this instrument should be turned on. By default, the Bluetooth function is set to on, however you can turn it on/off (page 29).

- 1. Hold down the [REC] and [PLAY] buttons simultaneously for three second or longer to pair with a Bluetooth-equipped device (Pairing*).**

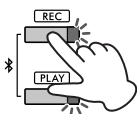

To cancel the pairing, press any button.

* Pairing:

To register this instrument with a Bluetooth-equipped device and establish mutual recognition for wireless communication between the two.

- 2. On the audio player, set the Bluetooth function to on and select the instrument “CLP-825 AUDIO” from the connection list**

Make sure to complete this operation while the [REC] and [PLAY] buttons are flashing.

- 3. Play back audio data on the Bluetooth-equipped device to confirm that the built-in speakers of the instrument can output the audio sound.**

Turning Bluetooth On/Off

To connect the instrument with a Bluetooth-equipped device via Bluetooth Audio or Bluetooth MIDI, you need to turn Bluetooth on.

While holding down [DEMO/SONG] and [PIANO/VOICE] simultaneously, press the F1 key to turn this parameter “Off” or the F#1 key to turn it “On.”

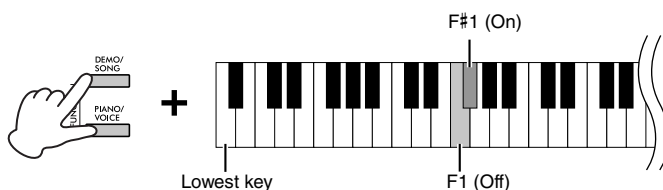

Default setting: On

About Bluetooth®

Bluetooth is a technology for wireless communication between devices within an area of about 10 meters (33 ft.) employing the 2.4 GHz frequency band.

Handling Bluetooth communications

- The 2.4 GHz band used by Bluetooth compatible devices is a radio band shared by many types of equipment. While Bluetooth compatible devices use a technology minimizing the influence of other components using the same radio band, such influence may reduce the speed or distance of communications and in some cases interrupt communications.
- The speed of signal transfer and the distance at which communication is possible differs according to the distance between the communicating devices, the presence of obstacles, radio wave conditions and the type of equipment.
- Yamaha does not guarantee all wireless connections between this unit and devices compatible with Bluetooth function.

Using the convenient Smart Pianist app

By connecting to a smart device such as a smartphone or tablet and using Smart Pianist, you have access to a variety of exceptionally convenient functions, such as viewing music scores and recording your performances to the device. The intuitive visual interface also helps you confirm the current settings of the instrument.



For details on the app and compatible devices, access the website below and check the “Smart Pianist” page.

<https://www.yamaha.com/kbdapps/>

After installing the Smart Pianist app on your smart device, connect this instrument to the device via USB cables or Bluetooth. For instructions on how to connect the device and use the app, refer to “Smart Pianist User Guide” (page 7).

NOTICE

All settings on the instrument are replaced by the settings on Smart Pianist when the instrument is connected with Smart Pianist.

NOTE

While Smart Pianist is connected, you cannot use the control panel on the instrument. Use Smart Pianist to control the instrument. To disconnect Smart Pianist, close Smart Pianist on the smart device or press the [DEMO/SONG] and [PIANO/VOICE] buttons simultaneously on the instrument. You can also disconnect from the smart pianist by turning off the power using the [⏻] (Standby/On) switch.

Connecting via Bluetooth

Before using the Bluetooth function, be sure to read “About Bluetooth” on page 29.

To connect the instrument and a smart device via Bluetooth, you need to make Bluetooth MIDI and Bluetooth Audio settings individually. In order to use Smart Pianist, Bluetooth MIDI connection is necessary. For listening to audio data on the smart device from the instrument, Bluetooth Audio connection is required as well.

NOTE

- Depending on the country in which you purchased the product, the instrument may not have Bluetooth capability (page 28).
- When the device is connected by Bluetooth, you cannot record in audio format by using Smart Pianist. To enable audio recording, connect via USB cable (see below).

1. Connect the instrument and the smart device by Bluetooth Audio (page 28).

When the connection is successful, audio data can be transmitted from the smart device to the instrument.

2. By using the Smart Pianist app, connect the instrument and the smart device via Bluetooth MIDI.

For details on connection, refer to “Smart Pianist User Guide” (page 7). Make sure to select “CLP-825 MIDI” for pairing. When the connection is successful, MIDI data can be transmitted/received between the instrument and the smart device.

Connecting with a USB cable ([USB TO HOST] terminal)

By using a USB cable, you can connect a smart device to the [USB TO HOST] terminal on the instrument. For instructions on connection, refer to “Smart Pianist User Guide” (page 7). Before using the [USB TO HOST] terminal, refer to “Precautions when using the [USB TO HOST] terminal” on page 27.

NOTICE

Use an AB type USB cable of less than 3 meters. The cable must be a communication cable compliant with USB standards, and not a charging-only cable.

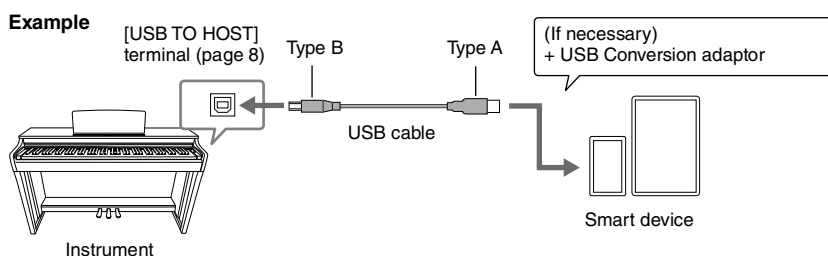

Backing up Data and Initializing the Settings

Data Maintained When Power is Turned Off

The following settings and data are maintained even if you turn the power off.

- | | |
|--|--|
| <ul style="list-style-type: none">• Metronome Volume• Metronome Beat (time signature)• Touch Sensitivity• Tuning• Intelligent Acoustic Control Depth• Intelligent Acoustic Control On/Off• Volume Limiter On/Off | <ul style="list-style-type: none">• Binaural Sampling/Stereophonic Optimizer On/Off• Operation Confirmation Sounds On/Off• Auto Power Off Enable/Disable• Speaker On/Off• User Song data• Duo Type Separated/Balanced |
|--|--|

Initializing the Settings

With this operation, all data (with the exception of the User Song and Bluetooth pairing information) will be reset to the factory default settings.

To do this, simultaneously hold down the C7 (the highest) key and turn on the power.

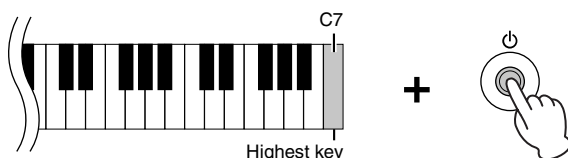

NOTICE

Never turn off the power while the Initialize operation is being executed (that is, while the [REC], [PLAY], [+R] and [-L] lamps are flashing).

NOTE

If this instrument somehow becomes disabled or malfunctions, turn off the power then execute Initialization.

Confirming the firmware version of this instrument

You can confirm the firmware version of your instrument by audible voice in English.

While holding down [DEMO/SONG] and [PIANO/VOICE] simultaneously, press the B0 key.

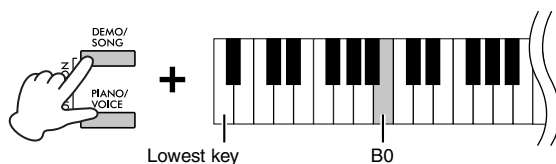

About the latest Firmware Version

Yamaha may from time to time update firmware of the product without notice for improvement. Make sure to check our website for information of the latest release and upgrade the firmware for your instrument.

<https://download.yamaha.com/>

Troubleshooting

Problem	Possible Cause and Solution
Power suddenly and unexpectedly turns off.	This is normal and the Auto Power Off function may have been activated (page 10). If desired, disable the Auto Power Off function.
The power of the instrument does not turn on.	The plugs are not properly connected. Make sure that the DC plug is securely inserted into the DC IN jack on the instrument, and that the AC plug is securely inserted to the AC outlet (page 10).
A click or pop is heard when the power is turned on or off.	This is normal when electrical current is being applied to the instrument.
Noise is heard from the speakers or headphones.	The noise may be due to interference caused by the use of a mobile phone in close proximity to this instrument. Turn off the mobile phone, or move it further away from this instrument.
	When you use the instrument along with the app on your smart device, we recommend that you enable "Airplane Mode" on the device to avoid noise caused by communication. When wirelessly connecting a smart device with this product, make sure that the Bluetooth setting on the device is turned on.
The overall volume is low, or no sound is heard.	The master volume is set too low. Set it to an appropriate level using the [VOLUME] knob (page 10).
	Make sure a pair of headphones or conversion adaptor is not connected to the [PHONES] jack (page 11).
	The Speaker setting is "Off." Set the Speaker to "Normal" or "On" (page 12).
	The Volume Limiter setting is "On." Set the Volume Limiter to "Off" (page 11).
Make sure that Local Control is On. For details, refer to the "MIDI Reference" (page 7).	
Pedals do not function.	The pedal cord may not be securely connected to the [TO PEDAL] jack. Be sure to insert the pedal cord all the way until the metal part of the cord plug disappears from view (page 13).
The pitch and sound quality of the Piano Voice is wrong in a specific key range.	This is no problem. Yamaha develops the Piano Voices so that the original piano sound is reproduced as faithfully as possible. This is why you may hear overtones emphasized in a certain key range, or you may feel that the sound pitch or quality is different from another key range.
Playing the keys produces a rattling noise.	This is no problem. The keyboard mechanism of this product is designed to simulate the actual noises of an acoustic piano. Such noises are produced even if you play an acoustic piano.
The [+R] and [-L] lamps flash when this product is started, when a Song is selected, or when recording is finished.	This is no problem. It is because the [+R] and [-L] lamps may flash when the internal processing of this product is taking a long time. Note that no operations are available while these are flashing.

Problem	Possible Cause and Solution
The Bluetooth-equipped audio player cannot be paired with nor connected to the instrument.	Check that the Bluetooth function of the audio player is activated. To connect the audio player and the instrument via Bluetooth, both devices need to be functional.
	The audio player and the instrument need to be paired to connect with each other via Bluetooth (page 28).
	In case there is a device (microwave oven, wireless LAN device, etc.) that outputs signals in the 2.4 GHz frequency band nearby, move this instrument away from the device that is emitting radio-frequency signals.

* Depending on the country in which you purchased the product, the instrument may not have Bluetooth capability. For information on whether Bluetooth functionality is included or not, refer to page 28.

For more information, check the “Frequently Asked Questions (FAQ)” on the following website:
<https://faq.yamaha.com/s/>

* Available in English, German, French, Spanish and some other languages.

Glossary of Terms

VRM (Virtual Resonance Modeling)

On an actual acoustic piano, if you press the damper pedal and play a key, not only does the string of the pressed key vibrate, it also causes other strings and the soundboard to vibrate, with each influencing the rest, creating a rich and brilliant resonance that sustains and expands. The VRM technology featured in this instrument reproduces the complicated interaction between both string and soundboard resonance, and make the sound more like that of a real acoustic piano. Since resonance instantaneously occurs depending on the action of the keys and pedal, you can expressively vary the sound by changing the timing of your pressing the keys, and the timing and depth of your pressing the pedal.

Grand Expression Modeling

On an actual acoustic piano, subtle changes in the sound can be produced by changing your playing touch from when you press a key to when you release it. For example, when you press a key all the way to its bottom, the key hits the keybed underneath and the noise reaches the strings, changing the sound slightly. Furthermore, the tone when the damper is lowered onto strings to mute the sound is changed by how quickly you release the key. The Grand Expression Modeling technology recreates these subtle changes in the sound that respond to your touch. This allows you to add accents by playing strongly or add resonance by playing softly to produce superbly expressive sound. A crisp tone can be heard when playing staccato as well as a lingering sound produced when releasing the keys slowly.

Keyboard Stand Assembly

⚠ CAUTION

- Assemble the unit on a hard and flat floor with ample space.
- Be careful not to confuse parts, and be sure to install all parts in the correct orientation. Please assemble the unit in accordance with the sequence given below.
- Assembly should be carried out by at least two persons.
- Be sure to use only the included screws of the specified sizes. Do not use any other screws. Use of incorrect screws can cause damage or malfunction of the product.
- Keep small parts (such as screws) out of the reach of infants. Children may accidentally swallow them.
- Be sure to tighten all screws upon completing assembly of the unit.
- To disassemble the unit, reverse the assembly sequence given below.

Have a Phillips-head (+) screwdriver of the appropriate size ready.

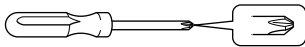

Remove all parts from the package and make sure you have all of the items.

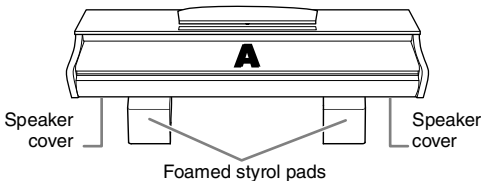

Remove foamed styrol pads from the package, position them on the floor, then place A on top of them. Position the pads so that they will not hide the connectors on the bottom of A.

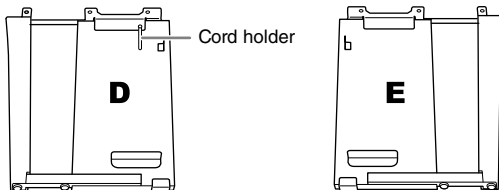
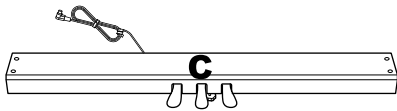

6 x 20 mm long screws × 4



4 x 12 mm thin screws × 2



4 x 20 mm tapping screws × 4



6 x 16 mm short screws × 6



4 x 10 mm thin screws × 2



Caps × 4



Power cord × 1



AC adaptor × 1

The power cord and adaptor may not be included, or may look different from the illustration above, depending on your particular area. Please check with your Yamaha dealer.



Headphone hanger × 1

1. Attach (finger-tighten) C to D and E.

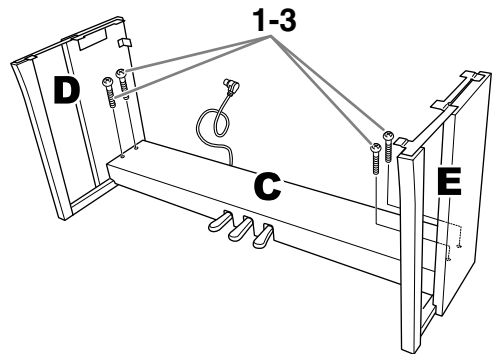

1-1 Untie and straighten out the bundled pedal cord.

1-2 Align D and E with each end of C.

1-3 Attach D and E to C by finger-tightening the long screws (6 × 20 mm).

2. Attach B.

Depending on the model of digital piano you purchased, the surface color of one side of B may be different from the other side. In this case, position B so that the side of the surface color similar to D and E faces the player.

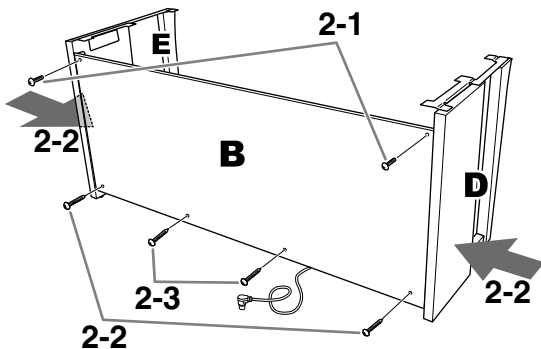

2-1 Align the screw holes on the upper side of B with the bracket holes on D and E, then attach the upper corners of B to D and E by finger-tightening two thin screws (4 × 12 mm).

2-2 While pushing the lower part of D and E from outside, secure the bottom ends of B using two tapping screws (4 × 20 mm).

2-3 Insert the other two tapping screws (4 × 20 mm) into the other two screw holes to secure B.

2-4 Securely tighten the screws on the top of B that were attached in Step 2-1.

3. Secure C.

3-1 Securely tighten the screws on C that were attached in Step 1-3.

3-2 Attach the caps to the head of the screws.

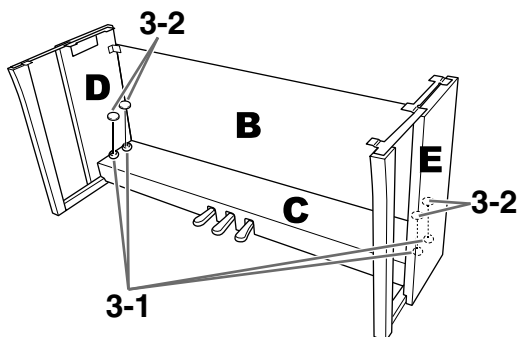

4. Mount A.

Be sure to place your hands at least 15 cm away from either end of the main unit when positioning it.

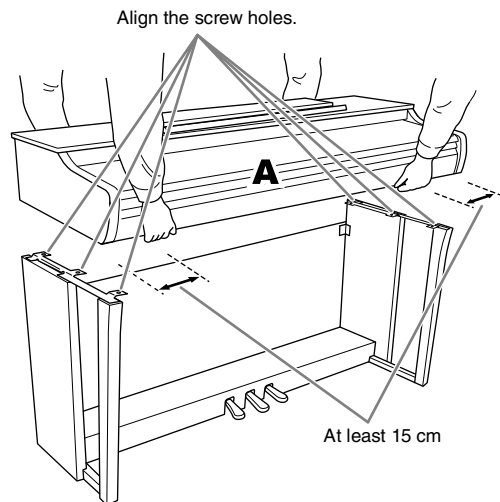

⚠ CAUTION

- Be extra careful not to drop the main unit or let your fingers be pinched by it.
- Do not hold the main unit in any position other than the position specified above.

5. Secure A.

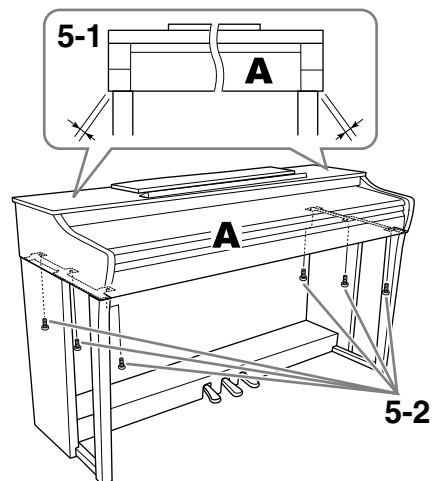

5-1 Adjust the position of A so that the left and right ends of A will project beyond D and E equally when seen from the front.

5-2 Secure A by tightening the short screws (6 × 16 mm) from the front.

6. Connect the pedal cord and the AC adaptor.

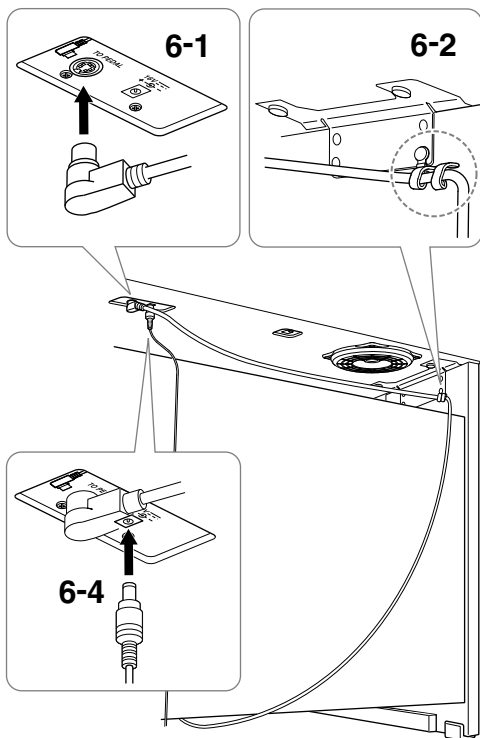

6-1 Insert the pedal cord plug to the pedal connector from the rear.

When connecting the pedal cord, insert the plug securely until the metal part disappears from view.

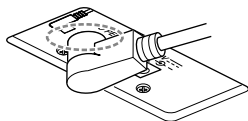

6-2 Securely wind the cord holder around the pedal cord.

The cord holder is attached to D.

6-3 Connect one end of the power cord to the AC adaptor.

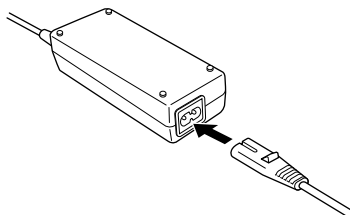

6-4 Insert the DC plug of the AC adaptor into the DC IN jack.

7. Set the adjuster.

Rotate the adjuster until it comes in firm contact with the floor surface.

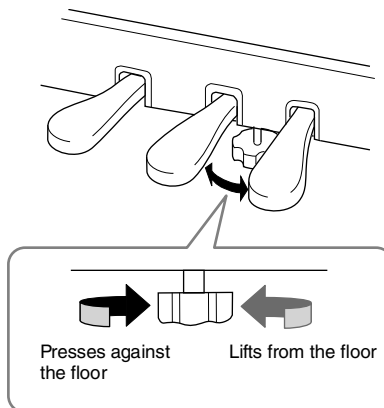

8. Attach the headphone hanger.

Use two thin screws (4 × 10 mm) to attach the hanger as shown in the illustration.

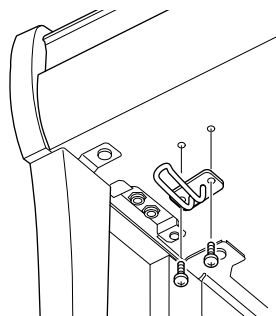

Post-assembly checklist

- There are no unused parts.
 - The instrument is stable even if you shake it.
 - The pedal adjuster is firmly pressed against to the floor surface.
 - Both the pedal cord and power cord are plugged securely into the correct jacks.
- If there are any items above you haven't confirmed, review the assembly procedure and correct any errors.

CAUTION

If the main unit creaks or is otherwise unsteady when you play on the keyboard, refer to the assembly diagrams and re-tighten all screws.

Specifications

			CLP-825
Product Name			Digital Piano
Size/Weight	Width [For models with polished finish]		1,350 mm (53-1/8") [1,353 mm (53-1/4")]
	Height [For models with polished finish]	With music rest closed	849 mm (33-7/16") [851 mm (33-1/2")]
		With music rest raised	1,003 mm (39-1/2") [1,005 mm (39-9/16")]
	Depth [For models with polished finish]		411 mm (16-3/16") [411 mm (16-3/16")]
	Weight [For models with polished finish]		45 kg (99 lb, 3 oz) [47 kg (103 lb, 10 oz)]
Control Interface	Keyboard	Number of Keys	88
		Type	GrandTouch-S Keyboard: synthetic ebony and ivory key tops, escapement
		Touch Sensitivity	Hard, Medium, Soft, Fixed
	Pedal	Number of Pedals	3: Damper (with Half-pedal function), Sostenuto, Soft
		GrandTouch Pedals	Yes
Panel	Language	English	
Cabinet	Key Cover Style		Sliding
	Music Rest		Yes (with music braces)
Voices	Tone Generator	Piano Sound	Yamaha CFX, Bösendorfer Imperial
		Binaural Sampling	Yes ("CFX Grand" only)
		VRM (Virtual Resonance Modeling)	Yes
		Grand Expression Modeling	Yes
	Polyphony (max.)		256
Preset	Number of Voices	10	
Effects	Types	Reverb	4 types
		Intelligent Acoustic Control (IAC)	Yes
		Stereophonic Optimizer	Yes
	Functions	Dual	Yes
		Duo	Yes
Songs	Preset	Number of Preset Songs	10 Voice Demo Songs, 50 Classics + 303 Lesson Songs
	MIDI Recording	Number of Songs	1
		Number of Tracks	2
		Data Capacity	Approx. 250 KB/Song (approx. 11,000 notes)
	Compatible Data Format	Playback	SMF (Format 0, Format 1)
Recording		SMF (Format 0)	
Functions	Overall Controls	Metronome	Yes
		Tempo Range	5 – 280
		Transpose	-6 – 0 – +6
		Tuning	414.8 – 440.0 – 466.8 Hz (approx. 0.2 Hz increments)
		USB Audio Interface	44.1 kHz, 24 bit, stereo

			CLP-825
Functions	Bluetooth (May not have this functionality depending on the country in which you purchased the product.)	Audio	Supported profile: A2DP, Compatible codec: SBC
		MIDI	Comply with Bluetooth Low Energy MIDI Specification
		Bluetooth version	5.0
		Wireless output	Bluetooth Class 2
		Maximum communication distance	Approx. 10 m
		Radio Frequency	2,401 – 2,481 MHz
		Maximum output power (EIRP)	4 dBm
		Type of modulation	GFSK
Storage and Connectivity	Connectivity	Headphones	Standard stereo phone jack (× 2)
		USB TO HOST	Type B
		DC IN	16 V
Amplifiers and Speakers	Amplifiers	20 W × 2	
	Speakers	12 cm with diffuser × 2	
Power Supply	AC Adaptor	PA-300C (Output: DC 16 V, 2.4 A)	
	Power Consumption	12 W	
	Auto Power Off	Yes	
Included Accessories		<ul style="list-style-type: none"> • Owner's Manual • "50 Classical Music Masterpieces" music book • Online Member Product Registration • Bench* • Power cord*/AC adaptor*: PA-300C * May not be included depending on your area. Check with your Yamaha dealer.	
Separately Sold Accessories (May not be available depending on your area.)		<ul style="list-style-type: none"> • Headphones: HPH-150, HPH-100, HPH-50 • Pedal unit: FC35 • AC adaptor: PA-300C 	

* The contents of this manual apply to the latest specifications as of the publishing date. To obtain the latest manual, access the Yamaha website then download the manual file. Since specifications, equipment or separately sold accessories may not be the same in every locale, please check with your Yamaha dealer.

Information for users on collection and disposal of old equipment:



This symbol on the products, packaging, and/or accompanying documents means that used electrical and electronic products should not be mixed with general household waste.

For proper treatment, recovery and recycling of old products, please take them to applicable collection points, in accordance with your national legislation.

By disposing of these products correctly, you will help to save valuable resources and prevent any potential negative effects on human health and the environment which could otherwise arise from inappropriate waste handling.

For more information about collection and recycling of old products, please contact your local municipality, your waste disposal service or the point of sale where you purchased the items.

For business users in the European Union:

If you wish to discard electrical and electronic equipment, please contact your dealer or supplier for further information.

Information on Disposal in other Countries outside the European Union:

This symbol is only valid in the European Union. If you wish to discard these items, please contact your local authorities or dealer and ask for the correct method of disposal.

Index

Numerics

50 Classical Music Masterpieces 23, 40

A

AC adaptor 10

Audio Loopback 28

Auto Power Off 10

B

Backing up Data 31

Beat 16

Binaural Sampling 12

Bluetooth 28

C

Computer 27

D

Damper Pedal 13

Delete 26

Demo Song List 18

Demo Songs 18

Dual mode 21

Duo 22

F

Firmware version 31

G

Grand Expression Modeling 15, 33

H

Half-pedal 13

Headphones 11

Hz (Hertz) 20

I

Initializing 31

Intelligent Acoustic Control (IAC) 14

K

Key Cover 9

L

Left-hand Part 24

Lesson Songs 40

M

Metronome 16

Music Rest 9

O

Octave 21

Operation Confirmation Sounds 15

P

Pairing 28

Panel Controls and Terminals 8

Pedals 13

Pitch 20

Playback 23

Power 10

Q

Quick Play 24

R

Recording 25

Reverb 19

Reverb Depth 19

Reverb Type 19

Right-hand Part 24

S

Smart Device 27

Smart Pianist 29

Smart Pianist User Guide 7

Soft Pedal 13

Song 23

Song List 40

Sostenuto Pedal 13

Speaker 12

Stereophonic Optimizer 12

T

Tempo 16

Time signature 16

Touch Sensitivity 15

Transpose 20

Tuning 20

U

USB Audio Interface 27

USB TO HOST 8, 27, 30

User Song 25

V

Voice 17

Voice List 17

Volume 8, 16

Volume Limiter 11

VRM (Virtual Resonance Modeling) 14, 33

Song List / Liste des morceaux

50 Classical Music Masterpieces (50 Classics)

No.	Song Title	Composer
Arrangements		
1	Canon D dur	J. Pachelbel
2	Air On the G String	J. S. Bach
3	Jesus, Joy of Man's Desiring	J. S. Bach
4	Twinkle, Twinkle, Little Star	Traditional
5	Piano Sonata op.31-2 "Tempest" 3rd mov.	L. v. Beethoven
6	Ode to Joy	L. v. Beethoven
7	Wiegenlied op.98-2	F. P. Schubert
8	Grande Valse Brillante	F. F. Chopin
9	Polonaise op.53 "Héroïque"	F. F. Chopin
10	La Campanella	F. Liszt
11	Salut d'amour op.12	E. Elgar
12	From the New World	A. Dvořák
13	Sicilienne	G. U. Fauré
14	Clair de lune	C. A. Debussy
15	Jupiter (The Planets)	G. Holst
Duets		
16	Menuett (Eine kleine Nachtmusik K.525)	W. A. Mozart
17	Menuett G dur	L. v. Beethoven
18	Marcia alla Turca	L. v. Beethoven
19	Piano Concerto No.1 op.11 2nd mov.	F. F. Chopin
20	The Nutcracker Medley	P. I. Tchaikovsky
Original Compositions		
21	Prelude (Wohltemperierte Klavier I No.1)	J. S. Bach
22	Menuett G dur BWV Anh.114	J. S. Bach
23	Piano Sonata No.15 K.545 1st mov.	W. A. Mozart
24	Turkish March	W. A. Mozart
25	Piano Sonata op.13 "Pathétique" 2nd mov.	L. v. Beethoven
26	Für Elise	L. v. Beethoven
27	Piano Sonata op.27-2 "Mondschein" 1st mov.	L. v. Beethoven
28	Impromptu op.90-2	F. P. Schubert
29	Frühlingslied op.62-6	J. L. F. Mendelssohn
30	Fantaisie-Impromptu	F. F. Chopin
31	Etude op.10-3 "Chanson de l'adieu"	F. F. Chopin
32	Etude op.10-12 "Revolutionary"	F. F. Chopin
33	Valse op.64-1 "Petit chien"	F. F. Chopin
34	Nocturne op.9-2	F. F. Chopin
35	Nocturne KK4a-16/BI 49 [Posth.]	F. F. Chopin
36	Träumerei	R. Schumann
37	Barcarolle	P. I. Tchaikovsky
38	La prière d'une Vierge	T. Badarzewska
39	Liebesträume No.3	F. Liszt
40	Blumenlied	G. Lange
41	Humoresque	A. Dvořák
42	Arietta	E. H. Grieg
43	Tango (España)	I. Albéniz
44	The Entertainer	S. Joplin
45	Maple Leaf Rag	S. Joplin
46	La Fille aux Cheveux de Lin	C. A. Debussy
47	Arabesque No.1	C. A. Debussy
48	Cakewalk	C. A. Debussy
49	Je te veux	E. Satie
50	Gymnopédies No.1	E. Satie

Lesson Songs

No.	Book Title	Title No. /Song Title	Composer
1-50	Vorschule im Klavierspiel op.101	1-106	F. Beyer
1-50		51-100	
1-6		101-106	
1-25	25 Etudes faciles et progressives op.100	1 La candeur	J. F. Burgmüller
		2 Arabesque	
		3 Pastorale	
		4 Petite réunion	
		5 Innocence	
		6 Progrès	
		7 Courant limpide	
		8 La gracieuse	
		9 La chasse	
		10 Tendre fleur	
		11 La bergeronnette	
		12 Adieu	
		13 Consolation	
		14 La styrienne	
		15 Ballade	
		16 Douce plainte	
		17 Babillarde	
		18 Inquiétude	
		19 Ave Maria	
		20 Tarentelle	
		21 Harmonie des anges	
		22 Barcarolle	
		23 Retour	
		24 L'hirondelle	
		25 La chevaleresque	
1-50	100 Übungsstücke op.139	1-50	C. Czerny
1-50		51-100	
1-30	30 Etudes de mécanisme op.849	1-30	C. Czerny
1-20 21-42	The Virtuoso Pianist	1-20 1-Variation. 1-22	C-L. Hanon

Duet Songs

- Nos. 16–20 of "50 Classical Music Masterpieces"
- Nos. 1–11 of the Vorschule im Klavierspiel op.101 of "Lesson Songs" as well as 32–34, 41–44, 63–64, and 86–87

The songs listed above are duet songs.

The right-hand part ([+R]) is for the right hand of the first player, and the left-hand part ([-L]) is for the left hand of the first player. The second player's parts cannot be turned off.

Les morceaux ci-dessus sont des duos.

La partie droite ([+R]) correspond à la main droite du premier interprète et la partie gauche ([-L]), à sa main gauche. Les parties du second interprète ne peuvent pas être désactivées.

For U.S.A.

This transmitter must not be co-located or operated in conjunction with any other antenna or transmitter.

(554-M01 FCC transmitter 01)

This equipment complies with FCC radiation exposure limits set forth for an uncontrolled environment and meets the FCC radio frequency (RF) Exposure Guidelines. This equipment has very low levels of RF energy that is deemed to comply without testing of specific absorption rate (SAR).

(554-M04 FCC portable 01)



Important Notice:

U.S. LIMITED WARRANTY for Customers in the United States

For detailed information about this Yamaha product and warranty service, please either visit the following website address (printable file is available at our website) or contact Customer Service at the address or telephone number identified below.

Website Address:

Yamaha.io/ClavinovaWarranty

Customer Service:

Yamaha Corporation of America
6600 Orangethorpe Avenue, Buena Park, CA 90620
Telephone: 800-854-1569

For Canada

This equipment complies with ISED radiation exposure limits set forth for an uncontrolled environment and meets RSS-102 of the ISED radio frequency (RF) Exposure rules as this equipment has very low levels of RF energy.

Cet équipement est conforme aux limites d'exposition aux rayonnements énoncées pour un environnement non contrôlé et respecte les règles d'exposition aux fréquences radioélectriques (RF) CNR-102 de l'ISDE puisque cet appareil a un niveau très bas d'énergie RF.

(0555-M05_ised_portable_01)

This device contains licence-exempt transmitter(s)/receiver(s) that comply with Innovation, Science and Economic Development Canada's licence-exempt RSS(s). Operation is subject to the following two conditions:

1. This device may not cause interference.
2. This device must accept any interference, including interference that may cause undesired operation of the device.

L'émetteur/récepteur exempt de licence contenu dans le présent appareil est conforme aux CNR d'Innovation, Sciences et Développement économique Canada applicables aux appareils radio exempts de licence. L'exploitation est autorisée aux deux conditions suivantes :

1. L'appareil ne doit pas produire de brouillage ;
2. L'appareil doit accepter tout brouillage radioélectrique subi, même si le brouillage est susceptible d'en compromettre le fonctionnement.

(555-M13 ISED RSS 01)

For United Kingdom

SIMPLIFIED UK DECLARATION OF CONFORMITY

Hereby, Yamaha Corporation declares that the [CLP-825] is in compliance with the Product Security and Telecommunications Infrastructure Regulations. The full text of the UK declaration of conformity is available at the following internet address:

<https://europe.yamaha.com/en/support/compliance/doc.html>

For European Union and United Kingdom

EN	SIMPLIFIED EU DECLARATION OF CONFORMITY / SIMPLIFIED UK DECLARATION OF CONFORMITY Hereby, Yamaha Corporation declares that the radio equipment type [CLP-825] is in compliance with Directive 2014/53/EU and the radio equipment regulations of UK. The full texts of the EU declaration of conformity and the UK declaration of conformity are available at the following internet address: https://europe.yamaha.com/en/support/compliance/doc.html
FR	DECLARATION UE DE CONFORMITE SIMPLIFIEE Le soussigné, Yamaha Corporation, déclare que l'équipement radioélectrique du type [CLP-825] est conforme à la directive 2014/53/UE. Le texte complet de la déclaration UE de conformité est disponible à l'adresse internet suivante : https://europe.yamaha.com/en/support/compliance/doc.html
DE	VEREINFACHTE EU-KONFORMITÄTSERKLÄRUNG Hiermit erklärt Yamaha Corporation, dass der Funkanlagentyp [CLP-825] der Richtlinie 2014/53/EU entspricht. Der vollständige Text der EU-Konformitätserklärung ist unter der folgenden Internetadresse verfügbar: https://europe.yamaha.com/en/support/compliance/doc.html
SV	FÖRENKLAD EU-FÖRSÄKRAN OM ÖVERENSSTÄMMELSE Härmed försäkrar Yamaha Corporation att denna typ av radioutrustning [CLP-825] överensstämmer med direktiv 2014/53/EU. Den fullständiga texten till EU-försäkrans om överensstämmelse finns på följande webbadress: https://europe.yamaha.com/en/support/compliance/doc.html
IT	DICHIARAZIONE DI CONFORMITÀ UE SEMPLIFICATA Il fabbricante, Yamaha Corporation, dichiara che il tipo di apparecchiatura radio [CLP-825] è conforme alla direttiva 2014/53/UE. Il testo completo della dichiarazione di conformità UE è disponibile al seguente indirizzo Internet: https://europe.yamaha.com/en/support/compliance/doc.html
ES	DECLARACIÓN UE DE CONFORMIDAD SIMPLIFICADA Por la presente, Yamaha Corporation declara que el tipo de equipo radioeléctrico [CLP-825] es conforme con la Directiva 2014/53/UE. El texto completo de la declaración UE de conformidad está disponible en la dirección Internet siguiente: https://europe.yamaha.com/en/support/compliance/doc.html
PT	DECLARAÇÃO UE DE CONFORMIDADE SIMPLIFICADA O(a) abaixo assinado(a) Yamaha Corporation declara que o presente tipo de equipamento de rádio [CLP-825] está em conformidade com a Diretiva 2014/53/UE. O texto integral da declaração de conformidade está disponível no seguinte endereço de Internet: https://europe.yamaha.com/en/support/compliance/doc.html
NL	VEREENVOUDIGDE EU-CONFORMITEITSVERKLARING Hierbij verklaar ik, Yamaha Corporation, dat het type radioapparatuur [CLP-825] conform is met Richtlijn 2014/53/EU. De volledige tekst van de EU-conformiteitsverklaring kan worden geraadpleegd op het volgende internetadres: https://europe.yamaha.com/en/support/compliance/doc.html
BG	ОПРОСТЕНА ЕС ДЕКЛАРАЦИЯ ЗА СЪОТВЕТСТВИЕ С настоящото Yamaha Corporation декларира, че този тип радиосъоръжение [CLP-825] е в съответствие с Директива 2014/53/ЕС. Цялостният текст на ЕС декларацията за съответствие може да се намери на следния интернет адрес: https://europe.yamaha.com/en/support/compliance/doc.html
CS	ZJEDNODUŠENÉ EU PROHLÁŠENÍ O SHODĚ Tímto Yamaha Corporation prohlašuje, že typ rádiového zařízení [CLP-825] je v souladu se směrnicí 2014/53/EU. Úplné znění EU prohlášení o shodě je k dispozici na této internetové adrese: https://europe.yamaha.com/en/support/compliance/doc.html
DA	FORENKLET EU-OVERENSSTEMMELSESESKLÆRING Hermed erklærer Yamaha Corporation, at radioudstyrstypen [CLP-825] er i overensstemmelse med direktiv 2014/53/EU. EU-overensstemmelsestærklæringens fulde tekst kan findes på følgende internetadresse: https://europe.yamaha.com/en/support/compliance/doc.html

ET	LIHTSUSTATUD ELI VASTAVUSDEKLARATSIOON Käesolevaga deklareerib Yamaha Corporation, et käesolev raadioseadme tüüp [CLP-825] vastab direktiivi 2014/53/EL nõuetele. ELi vastavusdeklaratsiooni täielik tekst on kättesaadav järgmisel internetiaadressil: https://europe.yamaha.com/en/support/compliance/doc.html
EL	ΑΠΛΟΥΣΤΕΥΜΕΝΗ ΔΗΛΩΣΗ ΣΥΜΜΟΡΦΩΣΗΣ ΕΕ Με την παρούσα ο/η Yamaha Corporation, δηλώνει ότι ο ραδιοεπιπλισμός [CLP-825] πληροί την οδηγία 2014/53/ΕΕ. Το πλήρες κείμενο της δήλωσης συμμόρφωσης ΕΕ διατίθεται στην ακόλουθη ιστοσελίδα στο διαδίκτυο: https://europe.yamaha.com/en/support/compliance/doc.html
HR	POJEDNOSTAVLJENA EU IZJAVA O SUKLADNOSTI Yamaha Corporation ovime izjavljuje da je radijska oprema tipa [CLP-825] u skladu s Direktivom 2014/53/EU. Cjeloviti tekst EU izjave o sukladnosti dostupan je na sljedećoj internetskoj adresi: https://europe.yamaha.com/en/support/compliance/doc.html
LV	VIENKĀRŠOTA ES ATBILSTĪBAS DEKLARĀCIJA Ar šo Yamaha Corporation deklarē, ka radioiekārta [CLP-825] atbilst Direktīvai 2014/53/ES. Pilns ES atbilstības deklarācijas teksts ir pieejams šādā interneta vietnē: https://europe.yamaha.com/en/support/compliance/doc.html
LT	SUPAPRASTINTA ES ATITIKTIES DEKLARACIJA Aš, Yamaha Corporation, patvirtinu, kad radijo įrenginių tipas [CLP-825] atitinka Direktyvą 2014/53/ES. Visas ES atitikties deklaracijos tekstas prieinamas šiuo interneto adresu: https://europe.yamaha.com/en/support/compliance/doc.html
HU	EGYSZERŰSÍTETT EU-MEGFELELŐSÉGI NYILATKOZAT Yamaha Corporation igazolja, hogy a [CLP-825] típusú rádióberendezés megfelel a 2014/53/EU irányelvnek. Az EU-megfelelőségi nyilatkozat teljes szövege elérhető a következő internetes címen: https://europe.yamaha.com/en/support/compliance/doc.html
PL	UPROSZCZONA DEKLARACJA ZGODNOŚCI UE Yamaha Corporation niniejszym oświadcza, że typ urządzenia radiowego [CLP-825] jest zgodny z dyrektywą 2014/53/UE. Pełny tekst deklaracji zgodności UE jest dostępny pod następującym adresem internetowym: https://europe.yamaha.com/en/support/compliance/doc.html
RO	DECLARAȚIA UE DE CONFORMITATE SIMPLIFICATĂ Prin prezenta, Yamaha Corporation declară că tipul de echipamente radio [CLP-825] este în conformitate cu Directiva 2014/53/UE. Textul integral al declarației UE de conformitate este disponibil la următoarea adresă internet: https://europe.yamaha.com/en/support/compliance/doc.html
SK	ZJEDNODUŠENÉ EÚ VYHLÁSENIE O ZHODE Yamaha Corporation týmto vyhlasuje, že rádiové zariadenie typu [CLP-825] je v súlade so smernicou 2014/53/EÚ. Úplné EÚ vyhlásenie o zhode je k dispozícii na tejto internetovej adrese: https://europe.yamaha.com/en/support/compliance/doc.html
SL	POENOSTAVLJENA IZJAVA EU O SKLADNOSTI Yamaha Corporation potrjuje, da je tip radijske opreme [CLP-825] skladen z Direktivo 2014/53/EU. Celotno besedilo izjave EU o skladnosti je na voljo na naslednjem spletnem naslovu: https://europe.yamaha.com/en/support/compliance/doc.html
FI	YKSINKERTAISTETTU EU-VAATIMUSTENMUKAISUUSVAKUUTUS Yamaha Corporation vakuuttaa, että radiolaitetyyppi [CLP-825] on direktiivin 2014/53/EU mukainen. EU-vaatimustenmukaisuusvakuutuksen täysimittainen teksti on saatavilla seuraavassa internetosoitteessa: https://europe.yamaha.com/en/support/compliance/doc.html
TR	BASİTLEŞTİRİLMİŞ AVRUPA BİRLİĞİ UYGUNLUK BİLDİRİMİ İşbu belge ile, Yamaha Corporation, radyo cihaz tipinin [CLP-825], Direktif 2014/53/ AB'ye uygunluğunu beyan eder. AB uyumu beyanının tam metni aşağıdaki internet adresinden edinilebilir: https://europe.yamaha.com/en/support/compliance/doc.html

(59-M01 RED DoC URL 03)

Important Notice: Power management information for customers in European Economic Area (EEA), Switzerland and Turkey

Remarque importante : Informations sur la gestion de l'alimentation pour les clients de l'Espace économique européen (EEE), de Suisse et de Turquie

The power management function of this equipment can be deactivated. In this case, the energy consumption will increase.	English
Die Energiesparfunktion dieses Geräts kann deaktiviert werden. In diesem Fall steigt der Energieverbrauch an.	Deutsch
Il est possible de désactiver la fonction de gestion de l'alimentation de cet équipement. Dans ce cas, la consommation d'énergie augmente.	Français
De functie voor energiebeheer van dit apparaat kan worden uitgeschakeld. In dit geval zal het energieverbruik toenemen.	Nederlands
La función de gestión de la energía de este equipo puede desactivarse. En este caso, el consumo de energía aumentará.	Español
La funzione di gestione dell'energia di questa apparecchiatura può essere disattivata. In questo caso, il consumo energetico aumenterà.	Italiano
É possível desativar a funcionalidade de gestão de energia deste equipamento. Neste caso, o consumo de energia irá aumentar.	Português
Η λειτουργία διαχείρισης ενέργειας αυτού του εξοπλισμού μπορεί να απενεργοποιηθεί. Σε αυτή την περίπτωση, η κατανάλωση ενέργειας θα αυξηθεί.	Ελληνικά
Utrustningens strömhanteringsfunktion kan avaktiveras. Strömförbrukningen ökar om detta görs.	Svenska
Dette udstyrs strømstyringsfunktion kan blive deaktiveret. I så fald vil energiforbruget stige.	Dansk
Tämän laitteen virranhallintatoiminnon voi poistaa käytöstä. Jos näin tehdään, energiankulutus kasvaa.	Suomi
Funkcję zarządzania energią tego urządzenia można wyłączyć. W takim przypadku zużycie energii wzrośnie.	Polski
Funkci správy výkonu je v zařízení možné deaktivovat. V takovém případě se zvýší spotřeba energie.	Čeština
A berendezés energiagazdálkodási funkciója kikapcsolható. Ebben az esetben az energiafogyasztás megnő.	Magyar
Selle seadme toitehalduse funktsiooni saab inaktiveerida. Sellisel juhul energiakulu suureneb.	Eesti
Šī aprīkojuma jaudas pārvaldības funkciju var deaktivizēt. Šajā gadījumā enerģijas patēriņš palielināsies.	Latviešu
Šios įrangos energijos sąnaudų valdymo funkciją galima išjungti. Tai padarius, energijos sąnaudos padidės.	Lietuvių
Funkciu riadenia spotreby tohto zariadenia možno deaktivovať. V takom prípade sa zvýši spotreba energie.	Slovenčina
Funkcija upravljanja porabe energije je za to opremo mogoče deaktivirati. V tem primeru se bo poraba energije povečala.	Slovenščina
Функцията за управление на мощността на това оборудване може да се дезактивира. В този случай консумацията на енергия ще се увеличи.	Български
Funcția de gestionare a energiei a acestui echipament poate fi dezactivată. În acest caz, consumul de energie va crește.	Română
Funkcija upravljanja napajanjem ove opreme može se deaktivirati. U tom će se slučaju povećati potrošnja energije.	Hrvatski
Bu ekipmanın güç yönetimi işlevi devre dışı bırakılabilir. Bu durumda, enerji tüketimi artacaktır.	Türkçe

Important Notice: Guarantee Information for customers in European Economic Area (EEA) and Switzerland

<p>Important Notice: Guarantee Information for customers in EEA* and Switzerland</p> <p>For detailed guarantee information about this Yamaha product, and Pan-EEA* and Switzerland warranty service, please either visit the website address below (Printable file is available at our website) or contact the Yamaha representative office for your country. * EEA: European Economic Area</p>	English
<p>Wichtiger Hinweis: Garantie-Information für Kunden in der EWR* und der Schweiz</p> <p>Für nähere Garantie-Information über dieses Produkt von Yamaha, sowie über den Pan-EWR*- und Schweizer Garantieservice, besuchen Sie bitte entweder die folgend angegebene Internetadresse (eine druckfähige Version befindet sich auch auf unserer Webseite), oder wenden Sie sich an den für Ihr Land zuständigen Yamaha-Vertrieb. *EWR: Europäischer Wirtschaftsraum</p>	Deutsch
<p>Remarque importante: informations de garantie pour les clients de l'EEE et la Suisse</p> <p>Pour des informations plus détaillées sur la garantie de ce produit Yamaha et sur le service de garantie applicable dans l'ensemble de l'EEE ainsi qu'en Suisse, consultez notre site Web à l'adresse ci-dessous (le fichier imprimable est disponible sur notre site Web) ou contactez directement Yamaha dans votre pays de résidence. * EEE : Espace Economique Européen</p>	Français
<p>Belangrijke mededeling: Garantie-informatie voor klanten in de EER* en Zwitserland</p> <p>Voor gedetailleerde garantie-informatie over dit Yamaha-product en de garantieservice in heel de EER* en Zwitserland, gaat u naar de onderstaande website (u vindt een afdrukbaar bestand op onze website) of neemt u contact op met de vertegenwoordiging van Yamaha in uw land. * EER: Europese Economische Ruimte</p>	Nederlands
<p>Aviso importante: información sobre la garantía para los clientes del EEE* y Suiza</p> <p>Para una información detallada sobre este producto Yamaha y sobre el soporte de garantía en la zona EEE* y Suiza, visite la dirección web que se incluye más abajo (la versión del archivo para imprimir esta disponible en nuestro sitio web) o póngase en contacto con el representante de Yamaha en su país. * EEE: Espacio Económico Europeo</p>	Español
<p>Avviso importante: informazioni sulla garanzia per i clienti residenti nell'EEA* e in Svizzera</p> <p>Per informazioni dettagliate sulla garanzia relativa a questo prodotto Yamaha e l'assistenza in garanzia nei paesi EEA* e in Svizzera, potete consultare il sito Web all'indirizzo riportato di seguito (è disponibile il file in formato stampabile) oppure contattare l'ufficio di rappresentanza locale della Yamaha. * EEA: Area Economica Europea</p>	Italiano
<p>Aviso importante: informações sobre as garantias para clientes da AEE* e da Suíça</p> <p>Para obter uma informação pormenorizada sobre este produto da Yamaha e sobre o serviço de garantia na AEE* e na Suíça, visite o site a seguir (o arquivo para impressão está disponível no nosso site) ou entre em contato com o escritório de representação da Yamaha no seu país. * AEE: Área Económica Europeia</p>	Português
<p>Σημαντική σημείωση: Πληροφορίες εγγύησης για τους πελάτες στον ΕΟΧ* και Ελλάδα</p> <p>Για λεπτομερείς πληροφορίες εγγύησης σχετικά με το παρόν προϊόν της Yamaha και την κάλυψη εγγύησης σε όλες τις χώρες του ΕΟΧ και την Ελλάδα, επισκεφτείτε την παρακάτω ιστοσελίδα (Εκτυπώσιμη μορφή είναι διαθέσιμη στην ιστοσελίδα μας) ή απευθυνθείτε στην αντιπροσωπεία της Yamaha στη χώρα σας. * ΕΟΧ: Ευρωπαϊκός Οικονομικός Χώρος</p>	Ελληνικά
<p>Viktigt: Garantiinformation för kunder i EES-området* och Schweiz</p> <p>För detaljerad information om denna Yamaha-produkt samt garantiservice i hela EES-området* och Schweiz kan du antingen besöka nedanstående webbadress (en utskriftsvänlig fil finns på webbplatsen) eller kontakta Yamahas officiella representant i ditt land. * EES: Europeiska Ekonomiska Samarbetsområdet</p>	Svenska
<p>Viktig merknad: Garantiinformasjon for kunder i EØS* og Sveits</p> <p>Detaljert garantiinformasjon om dette Yamaha-produktet og garantiservice for hele EØS-området* og Sveits kan fås enten ved å besøke nettstedene nedenfor (utskriftsversjon finnes på våre nettsider) eller kontakte kontakta Yamaha-kontoret i landet der du bor. *EØS: Det europeiske økonomiske samarbeidsområdet</p>	Norsk
<p>Vigtig oplysning: Garantioplysninger til kunder i EØO* og Schweiz</p> <p>De kan finde detaljerede garantioplysninger om dette Yamaha-produkt og den fælles garantiserviceordning for EØO* (og Schweiz) ved at besøge det websted, der er angivet nedenfor (der findes en fil, som kan udskrives, på vores websted), eller ved at kontakte Yamahas nationale repræsentationskontor i det land, hvor De bor. * EØO: Det Europæiske Økonomiske Område</p>	Dansk
<p>Tärkeä ilmoitus: Takuutiedot Euroopan talousalueen (ETA)* ja Sveitsin asiakkaille</p> <p>Tämän Yamaha-tuotteen sekä ETA-alueen ja Sveitsin takuuta koskevat yksityiskohtaiset tiedot saatte alla olevasta nettiosoitteesta. (Tulostettava tiedosto saatavissa sivustollamme.) Voit myös ottaa yhteyttä paikalliseen Yamaha-edustajaan. *ETA: Euroopan talousalue</p>	Suomi
<p>Ważne: Warunki gwarancyjne obowiązujące w EOG* i Szwajcarii</p> <p>Aby dowiedzieć się więcej na temat warunków gwarancyjnych tego produktu firmy Yamaha i serwisu gwarancyjnego w całym EOG* i Szwajcarii, należy odwiedzić wskazaną poniżej stronę internetową (Plik gotowy do wydruku znajduje się na naszej stronie internetowej) lub skontaktować się z przedstawicielstwem firmy Yamaha w swoim kraju. * EOG — Europejski Obszar Gospodarczy</p>	Polski
<p>Důležité oznámení: Záruční informace pro zákazníky v EHS* a ve Švýcarsku</p> <p>Podrobné záruční informace o tomto produktu Yamaha a záručním servisu v celém EHS* a ve Švýcarsku naleznete na níže uvedené webové adrese (soubor k tisku je dostupný na našich webových stránkách) nebo se můžete obrátit na zástupce firmy Yamaha ve své zemi. * EHS: Evropský hospodářský prostor</p>	Česky
<p>Fontos figyelemzetés: Garancia-információk az EGT* területén és Svájcban élő vásárlók számára</p> <p>A jelen Yamaha termékre vonatkozó részletes garancia-információk, valamint az EGT*-re és Svájcra kiterjedő garanciális szolgáltatás tekintetében keresse fel webhelyünket az alábbi címen (a webhelyen nyomtatható fájl is talál), vagy pedig lépjen kapcsolatba az országában működő Yamaha képviselői irodával. * EGT: Európai Gazdasági Térség</p>	Magyar
<p>Oluline märkus: Garantiteave Euroopa Majanduspiirkonna (EMP)* ja Šveitsi klientidele</p> <p>Täpsemate teabe saamiseks selle Yamaha toote garantii ning kogu Euroopa Majanduspiirkonna ja Šveitsi garantiteeninduse kohta, külastage palun veebisaiti alljärgneval aadressil (meie saidil on saadaval printitav fail) või pöörduge Teie regiooni Yamaha esinduse poole. * EMP: Euroopa Majanduspiirkond</p>	Eesti keel
<p>Svarīgs paziņojums: garantijas informācija klientiem EEZ* un Šveicē</p> <p>Lai saņemtu detalizētu garantijas informāciju par šo Yamaha produktu, kā arī garantijas apkalpošanu EEZ* un Šveicē, lūdzam apmeklēt vietnā norādīto tīmekļa vietnes adresi (tīmekļa vietnē ir pieejams drukājams fails) vai sazināties ar jūsu valsti apkalpojošo Yamaha pārstāvniecību. * EEZ: Eiropas Ekonomikas zona</p>	Latviešu
<p>Dėmesio: informacija dėl garantijos pirkėjams EEE* ir Šveicarijoje</p> <p>Jei reikia išsamios informacijos apie šį „Yamaha“ produktą ir jo techninę priežiūrą visoje EEE* ir Šveicarijoje, apsilankykite mūsų svetainėje toliau nurodytu adresu (svetainėje yra spausdinamas failas) arba kreipkitės į „Yamaha“ atstovybę savo šalyje. *EEE – Europos ekonominė erdvė</p>	Lietuvių kalba
<p>Dôležité upozornenie: Informácie o záruke pre zákazníkov v EHP* a Švajčiarsku</p> <p>Podrobné informácie o záruke týkajúce sa tohto produktu od spoločnosti Yamaha a garančnom servise v EHP* a Švajčiarsku nájdete na webovej stránke uvedenej nižšie (na našej webovej stránke je k dispozícii súbor na tlač) alebo sa obráťte na zástupcu spoločnosti Yamaha vo svojej krajine. * EHP: Európsky hospodársky priestor</p>	Slovenčina
<p>Pomembno obvestilo: Informacije o garanciji za kupce v EGP* in Švici</p> <p>Za podrobnejše informacije o tem Yamahinem izdelku ter garancijskem servisu v celotnem EGP in Švici, obiščite spletno mesto, ki je navedeno spodaj (natiskljiva datoteka je na voljo na našem spletnem mestu), ali se obrnite na Yamahinega predstavnika v svoji državi. * EGP: Evropski gospodarski prostor</p>	Slovenščina
<p>Важно съобщение: Информация за гаранцията за клиенти в ЕИП* и Швейцария</p> <p>За подробна информация за гаранцията за този продукт на Yamaha и гаранционното обслужване в паневропейската зона на ЕИП* и Швейцария или посетете посочения по-долу уеб сайт (на нашия уеб сайт има файл за печат), или се свържете с представителния офис на Yamaha във вашата страна. * ЕИП: Европейско икономическо пространство</p>	Български език
<p>Notificare importantă: Informații despre garanție pentru clienții din SEE* și Elveția</p> <p>Pentru informații detaliate privind acest produs Yamaha și serviciul de garanție Pan-SEE* și Elveția, vizitați site-ul la adresa de mai jos (fișierul imprimabil este disponibil pe site-ul nostru) sau contactați biroul reprezentanței Yamaha din țara dumneavoastră. * SEE: Spațiul Economic European</p>	Limba română
<p>Važna obavijest: Informacije o jamstvu za države EGP-a i Švicarske</p> <p>Za detaljne informacije o jamstvu za ovaj Yamahin proizvod te jamstvenom servisu za cijeli EGP i Švicarsku, molimo Vas da posjetite web-stranicu navedenu u nastavku ili kontaktirate ovlaštenog Yamahinog dobavljača u svojoj zemlji. * EGP: Evropski gospodarski prostor</p>	Hrvatski

<https://europe.yamaha.com/warranty/>

Yamaha Worldwide Representative Offices

English

For details on the product(s), contact your nearest Yamaha representative or the authorized distributor, found by accessing the 2D barcode below.

Deutsch

Wenden Sie sich für nähere Informationen zu Produkten an eine Yamaha-Vertretung oder einen autorisierten Händler in Ihrer Nähe. Diese finden Sie mithilfe des unten abgebildeten 2D-Strichodes.

Français

Pour obtenir des informations sur le ou les produits, contactez votre représentant ou revendeur agréé Yamaha le plus proche. Vous le trouverez à l'aide du code-barres 2D ci-dessous.

Español

Para ver información detallada sobre el producto, contacte con su representante o distribuidor autorizado Yamaha más cercano. Lo encontrará escaneando el siguiente código de barras 2D.

Português

Para mais informações sobre o(s) produto(s), fale com seu representante da Yamaha mais próximo ou com o distribuidor autorizado acessando o código de barras 2D abaixo.

Русский

Чтобы узнать подробнее о продукте (продуктах), свяжитесь с ближайшим представителем или авторизованным дистрибьютором Yamaha, воспользовавшись двухмерным штрихкодом ниже.

Bahasa Indonesia

Untuk detail produk, hubungi perwakilan Yamaha terdekat atau distributor resmi Anda dengan mengakses barcode 2D di bawah ini.

简体中文

如需有关产品的详细信息, 请联系距您最近的 Yamaha 代表或授权经销商, 可通过访问下方的二维码找到这些代表或经销商的信息。

繁體中文

如需產品的詳細資訊, 請聯絡與您距離最近的 Yamaha 銷售代表或授權經銷商, 您可以掃描下方的二維條碼查看相關聯絡資料。

한국어

제품에 대한 자세한 정보는 아래 2D 바코드에 액세스하여 가까운 Yamaha 담당 판매점 또는 공식 대리점에 문의하십시오.



https://manual.yamaha.com/dmi/address_list/

Head Office/Manufacturer: Yamaha Corporation 10-1, Nakazawa-cho, Chuo-ku, Hamamatsu, 430-8650, Japan

Importer (European Union): Yamaha Music Europe GmbH Siemensstrasse 22-34, 25462 Rellingen, Germany

Importer (United Kingdom): Yamaha Music Europe GmbH (UK) Sherbourne Drive, Tilbrook, Milton Keynes, MK7 8BL, United Kingdom

DMI36_10m

