

SB168-ES and M7CL Quick Setup Guide

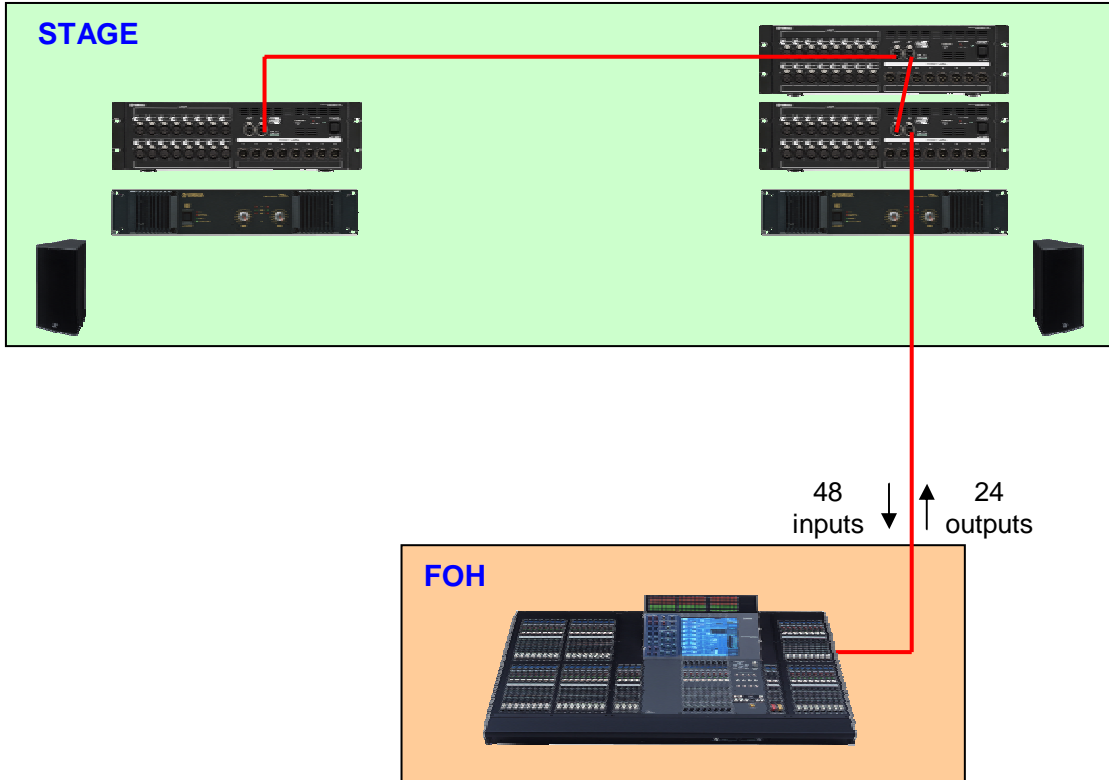

About This Guide

This guide describes quick and easy setup of the 48 inputs and 24 outputs stagebox system using three SB168-ESs and M7CL-48 with MY16-ES64 and MY16-EXs.



The same instructions and downloaded files can be used for easy setup of the 32 inputs and 16 outputs stagebox system using two SB168-ESs and M7CL-32 with MY16-ES64 and MY16-EX.

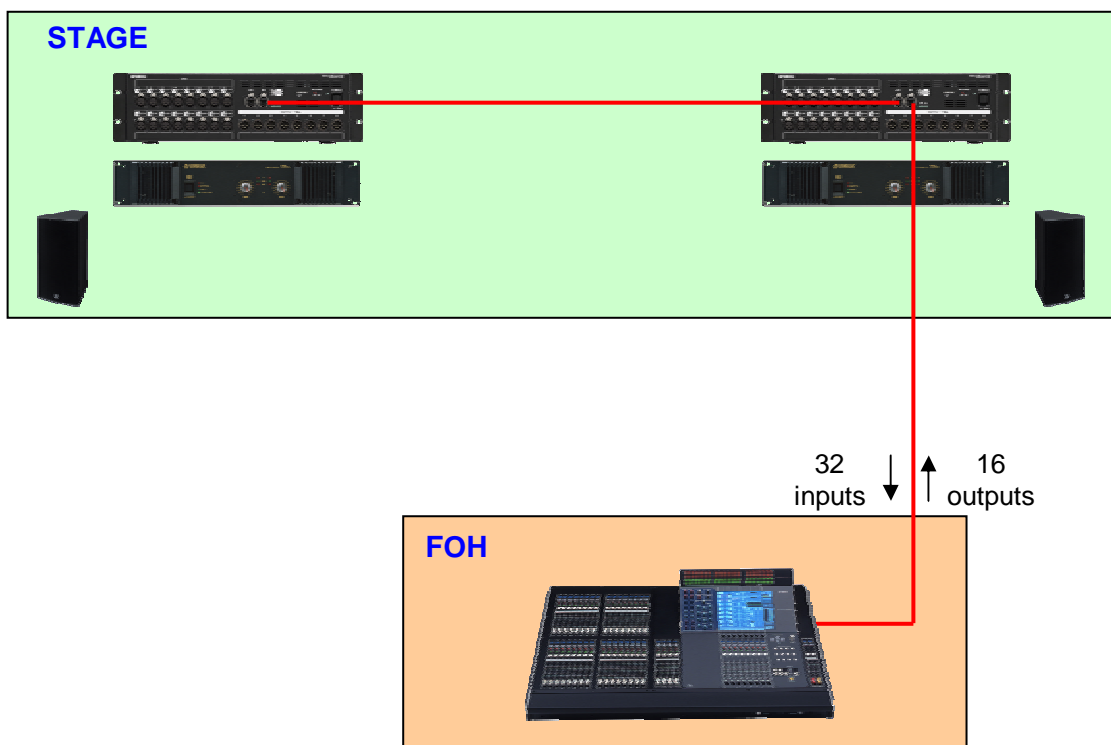

Step 1: Device Setup and Connections

Set the MY cards as follows.

DIP switch setting of MY16-ES64

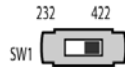
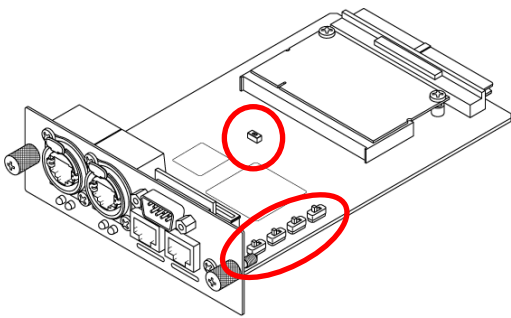

Set SW1 to the [422] position.



Set SW2 to the [48K] position.

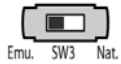

Set SW3 to the [Emu.] position.



Set SW4 to the [OnChip] position.



Leave SW201 permanently set to the [OFF] position.

DIP switch setting of MY16-EX #1 (and #2)

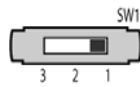
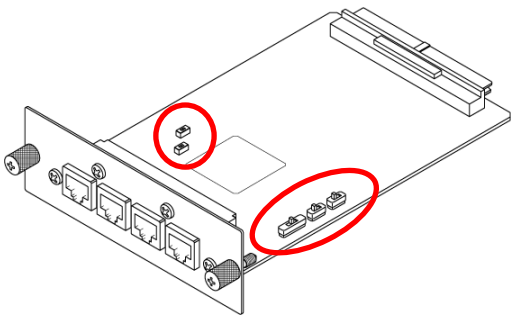

For MY16-EX #1, set SW1 to the [1] position.

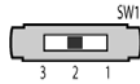

(For MY16-EX #2, set SW1 to the [2] position)



Set SW2 to the [48K] position.



Set SW3 to the [Emu.] position.



Leave these switches permanently set to the [OFF] position.



SB168-ES and M7CL Quick Setup Guide

Set the SB168-ES ID#s and connect all devices as follows, and then turn on all the devices.

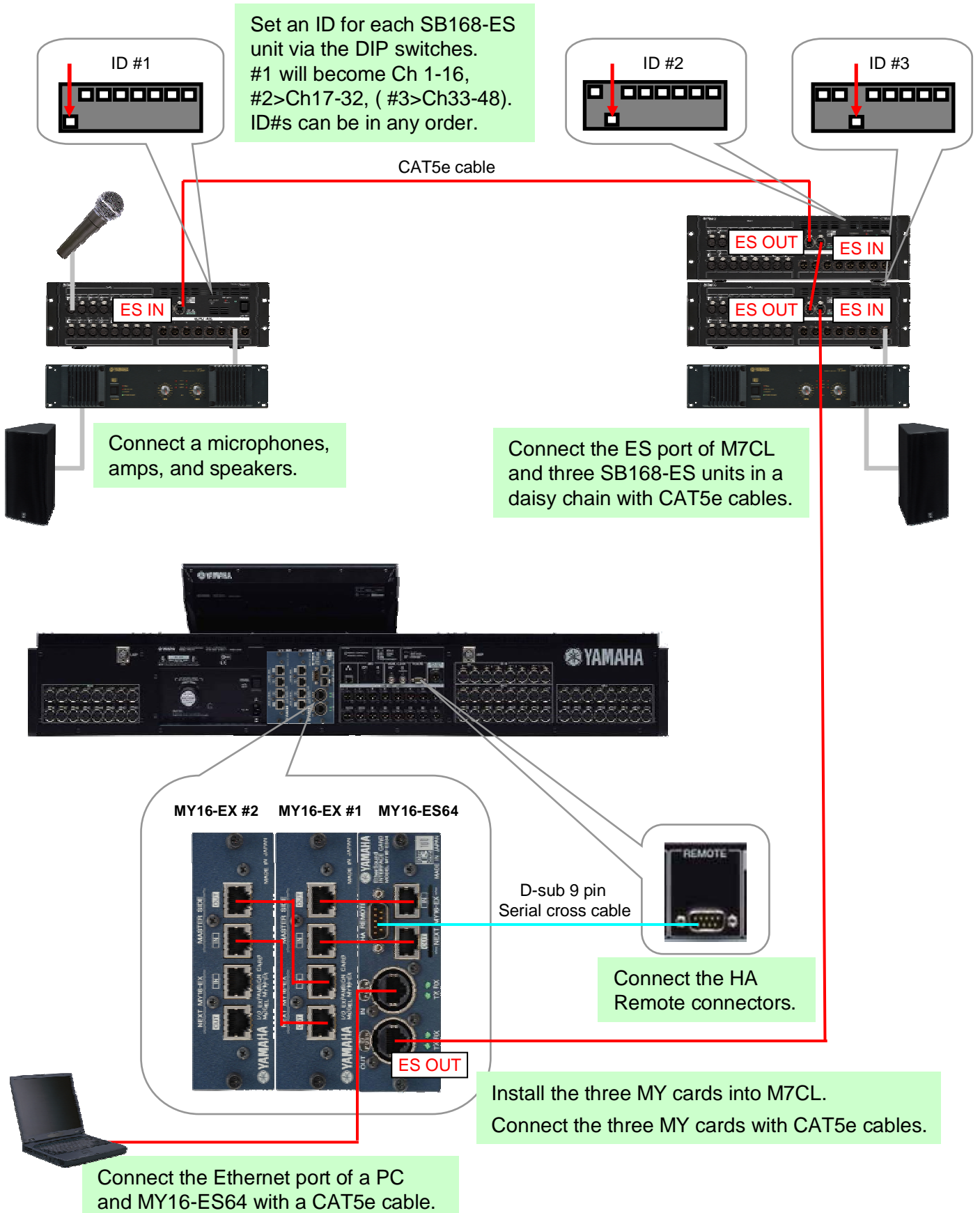

Step 2: EtherSound Network Setup

To setup the EtherSound network, a software application AVS-ESMonitor by AuviTran is used. Download and install AVS-ESMonitor from AuviTran's website.

<http://www.auvitran.com/>

Note: AVS-ESMonitor versions 3.5 and later support the SB168-ES.

Initial setup for AVS-ESMonitor

Select

Windows Start Menu >> Programs >> AuviTran >> EtherSound Monitor >> ES-Control Panel

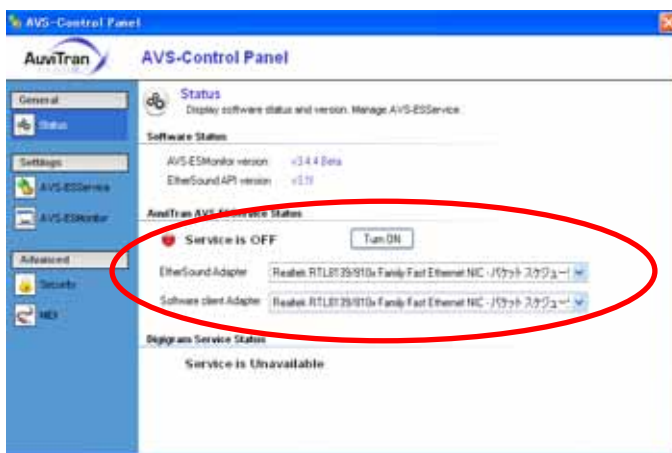

- Make sure the Service is ON.
- Select the "EtherSound Adapter" (Ethernet port of your PC connected to MY16-ES64)

Quick Setup procedure

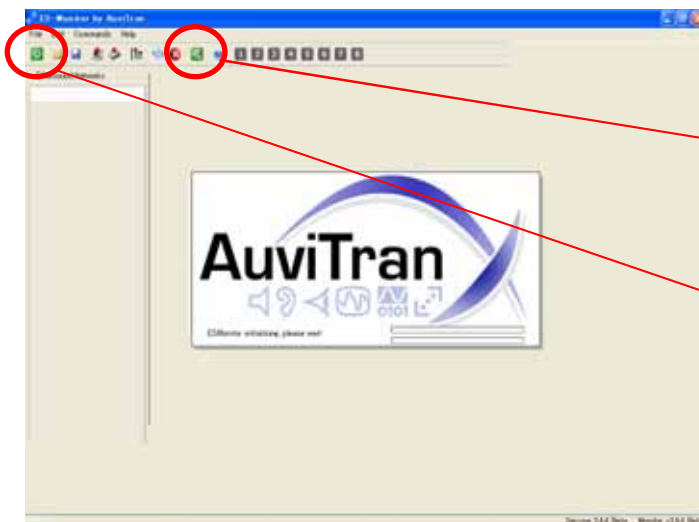

Launch the AVS-ESMonitor.

1. Make sure the mode is Online.



2. Click the [Reset ES Networks] button.



SB168-ES and M7CL Quick Setup Guide

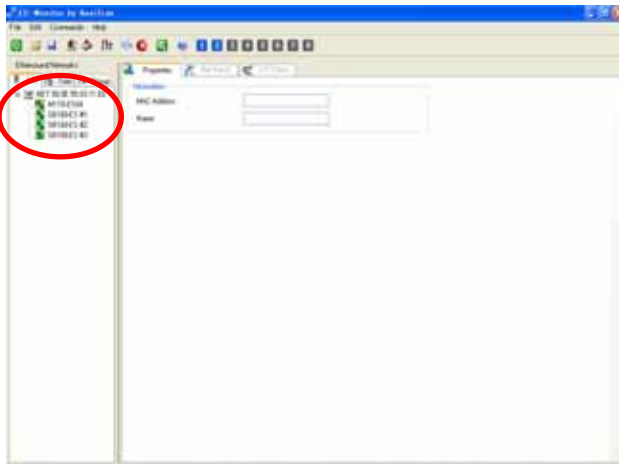

Devices being connected on a EtherSound network will be displayed on the "List" view.

Select any SB168-ES device.

Note; Devices are listed in order by their MAC address in the default state, but can be named in the "Properties" page for easier operation.

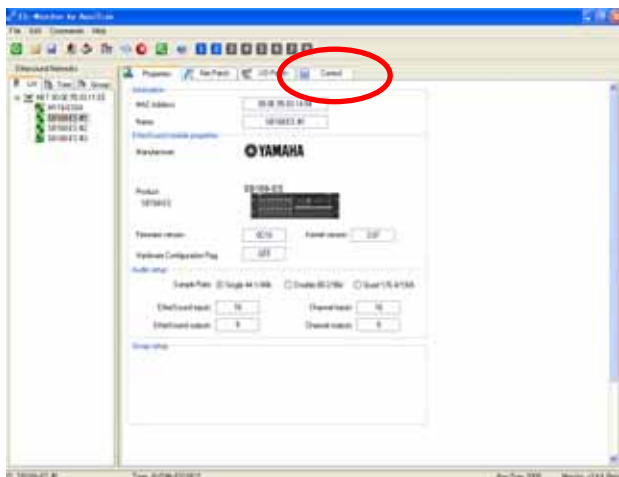

The "Properties" page of SB168-ES is displayed on the screen.

Click the [Control] tab to open the "Control" Page of SB168-ES.

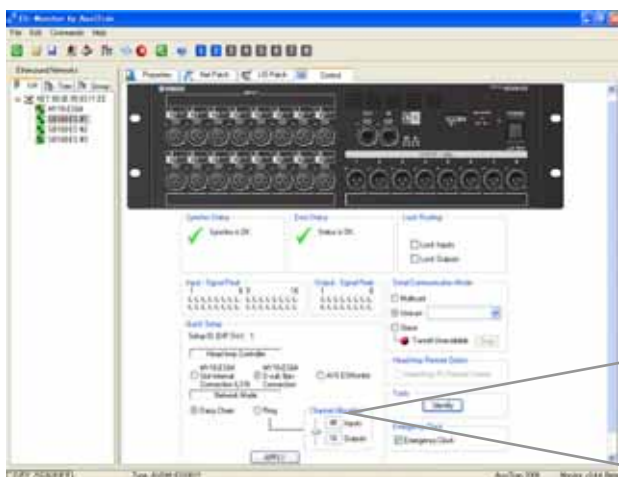

In the Quick Setup area

- Select [MY16-ES64 D-sub 9pin Connection].
- Select [Daisy Chain]. (See Appendix G for Ring setup information)
- Click the [APPLY] button.

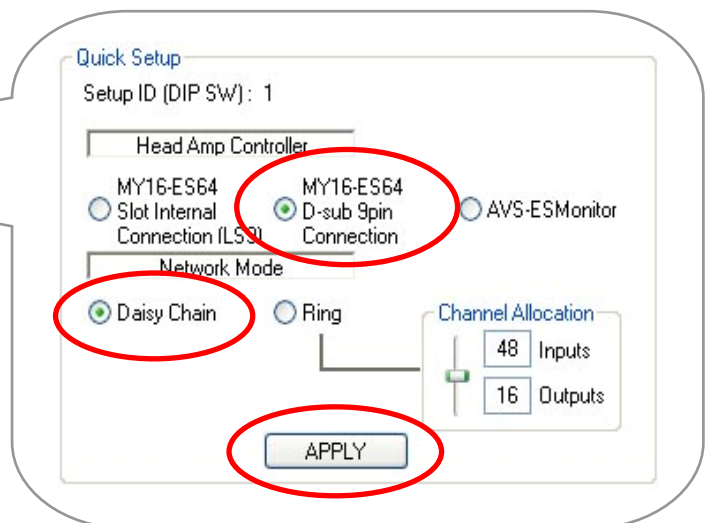

After the confirm box is checked all the network patching is done. HA control routing is setup and all information is saved to the EtherSound devices so they will remember after AVS-ESMonitor is disconnected or the power is cycled.

Step 3: M7CL Console Setup

Loading the M7CL Session File available on Yamaha Pro Audio website achieves all the settings of the M7CL.

–Download the “SB168-ES.M7C” file from the website to your USB key.

http://www.yamahaproaudio.com/training/self_training/

– Load the “SB168-ES.M7C” file to your M7CL.



Note: Loading session file into M7CL will clear all the existing SCENEs and setup data. If you have existing SCENEs and/or setup data on the console, please refer to Appendix F.

–Recall SCENE 001.

The SB168-ES.M7C file patches the slot inputs to the console channels instead of the XLR inputs on the console rear. It also assigns the HA control information to pass out of the console to remote control the SB168-ES Head Amps.

Tip: Treat SCENE 001 of this file like SCENE 000 on a mixer without SB168-ES.

SB168-ES channels are now patched as the image below. In the case of M7CL-32 there may be no third stagebox and further manual patching should be done to access Matrix channels. For manual patching of M7CL consoles see Appendix C.



All setup procedure has been completed, you are ready to soundcheck!

Appendices

After following the three simple steps your M7CL and SB168-ES stagebox system is setup and ready to work for most situations without any further changes.

However, adding SB168-ES and MY16-ES64 to M7CL does not simply provide remote input/output. The stagebox solution also adds network functionality using EtherSound technology. EtherSound provides options for a more flexible, expandable system such as splits for monitor consoles, digital recording, and staying digital from mic preamp right through to power amp etc... There are more than 30 partners making EtherSound devices so integration with other manufacturers and standards is made easy.

This Appendix section offers further details to explain your system, how to make patch changes and describes how to work within a more complex system for advanced users.

Contents

- A: Which patching system to use when?
- B: Signal flow between SB168-ES and M7CL
- C: Manual patch of M7CL
- D: Manual patch of EtherSound
- E: Manual setting of Remote HA
- F: Assigning stagebox patch to existing SCENEs
- G: Using the Ring setting in Quick Setup

Appendix A: Which patching system to use when?

Traditional analog systems can be patched at the stagebox or the console rear panel. Traditional digital systems are the same, but rear panel patching is replaced by software. SB168-ES uses a network system that introduces another patch option.

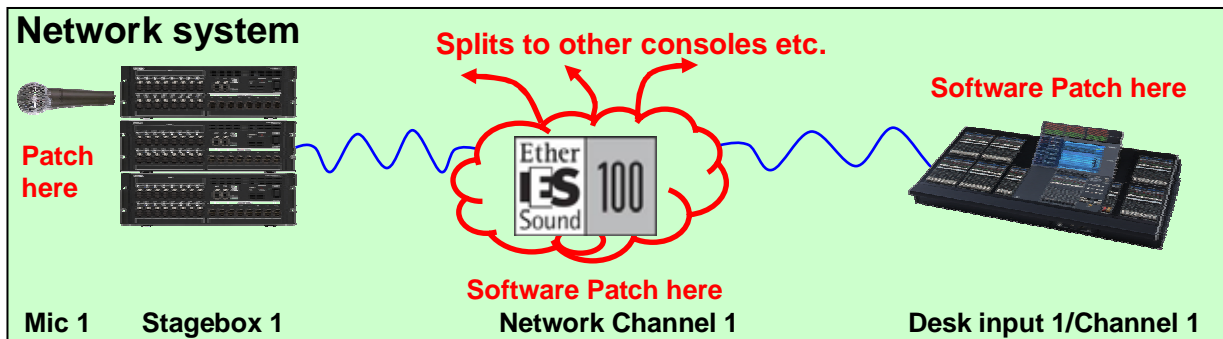
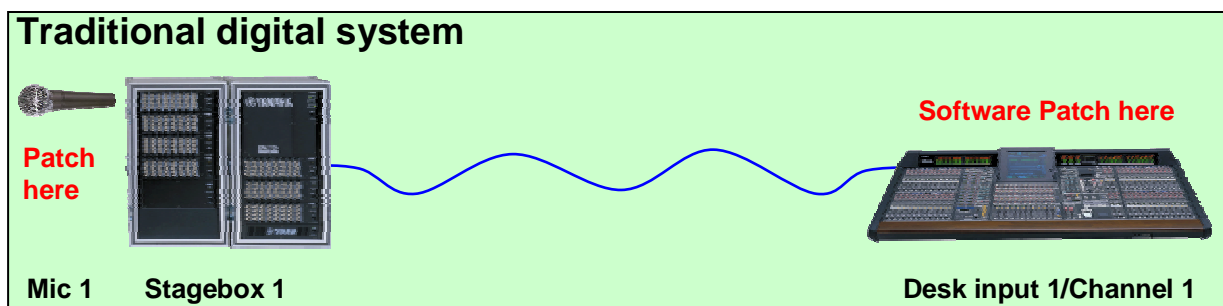
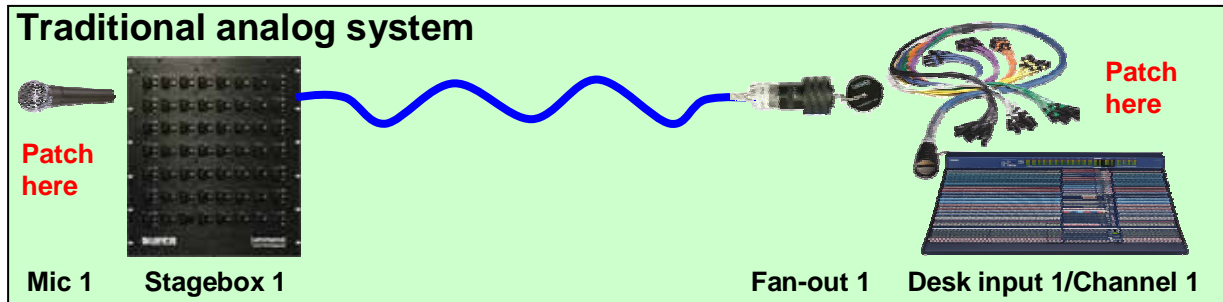

Use the AVS-ESMonitor Quick Setup feature to achieve network patching in one easy step. After it is set your system can work just like the traditional digital system, no further network patching is necessary, unless you redesign the system. However, the addition of a network to your setup prepares you for future upgrades of your signal path.

Use the network patch system to create digital splits to a recording or add a broadcast or monitor desk split. Use the network to route channels to signal processors like DME-ES or other manufacturers ES equipped units. Use network channels to create tie-lines from one SB168 to another without going through console channels. **Note**; changing the network patch can affect all the units connected to the network. Use it for setup only. (see Appendix D)

Use the M7CL patch system where you want to effect only *your* console patching. **Note**; the M7CL patch is part of the console SCENE recall system, and recalling SCENES does not affect audio to other units (unless you are remote controlling HA gain and +48V via the network) . (see Appendix C, E)

Appendix B: Signal flow between SB168-ES and M7CL

The signal flow of the stagebox system built in Quick Setup are shown below. Understanding this diagram helps you to build more flexible stagebox solutions using manual settings.

Inputs

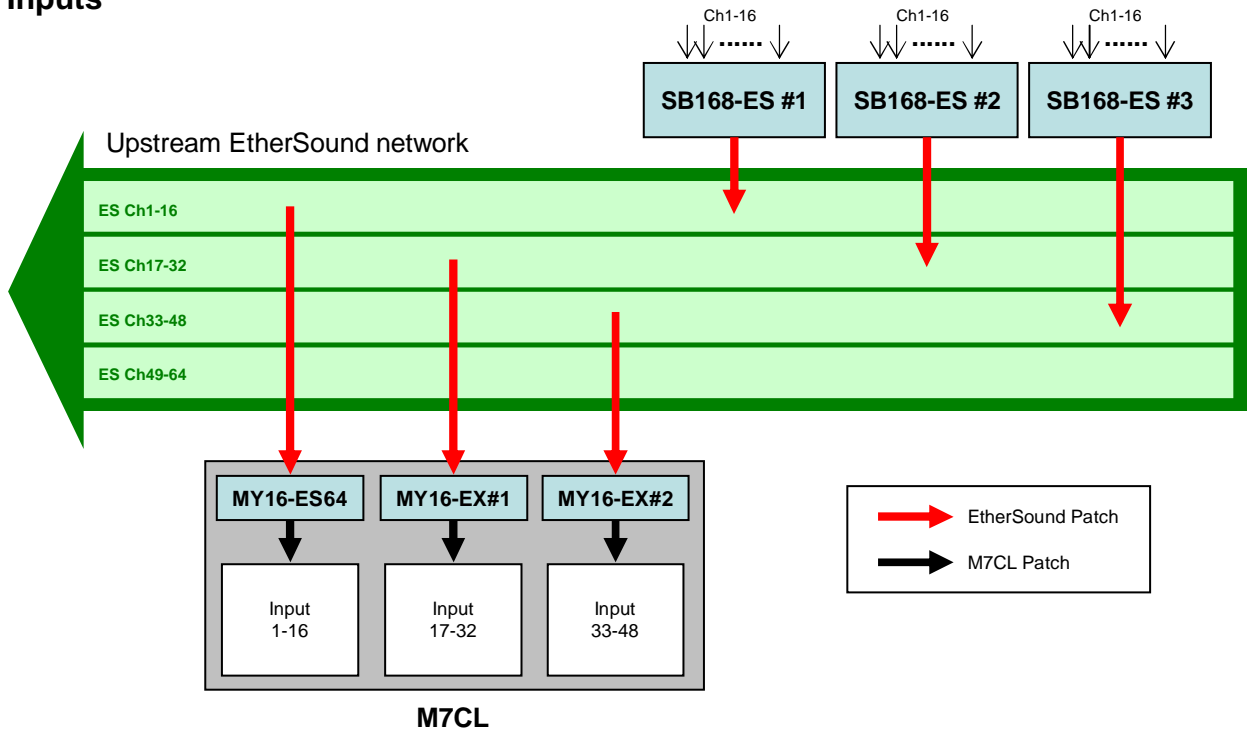

Outputs

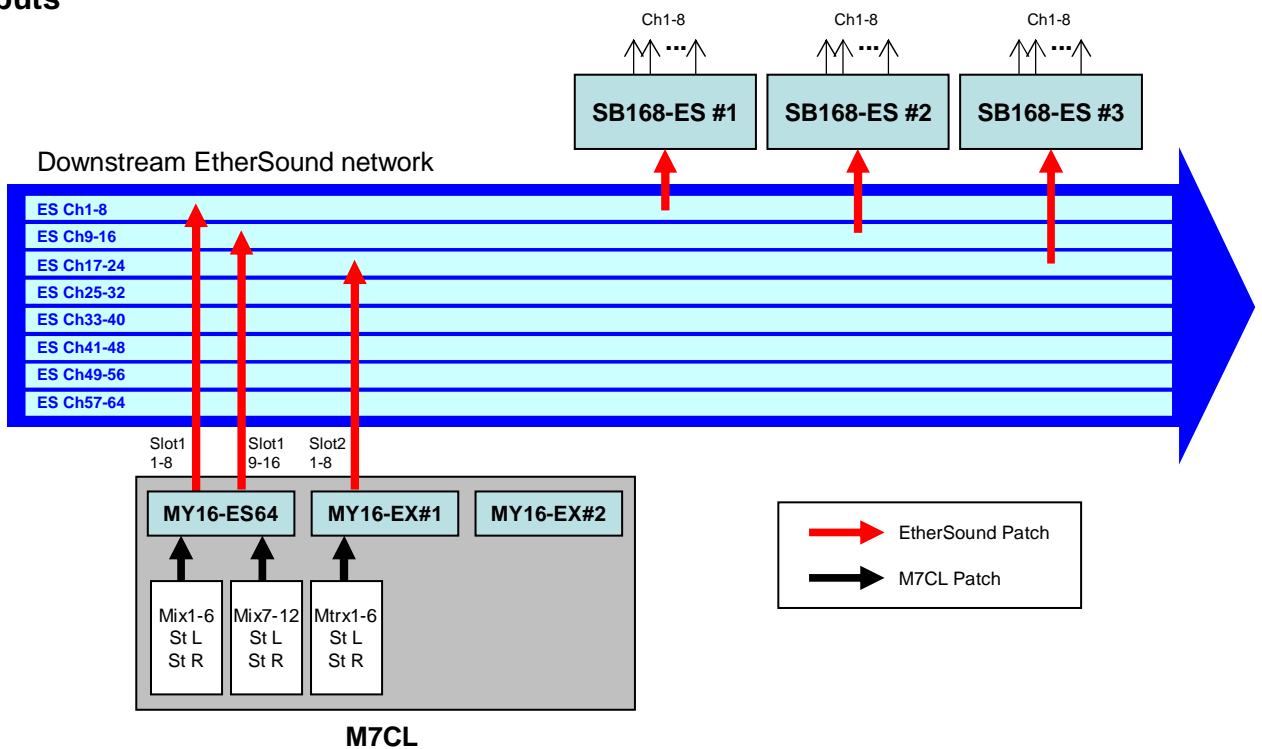

Appendix C: Manual patch of M7CL

Input patching

When the M7CL is in its default state, rear panel Input jacks 1-48 are patched to Input channels 1-48. However, input patching can be changed as desired.

This example explains how to patch Slot in ports to Input channels 1-48 manually.

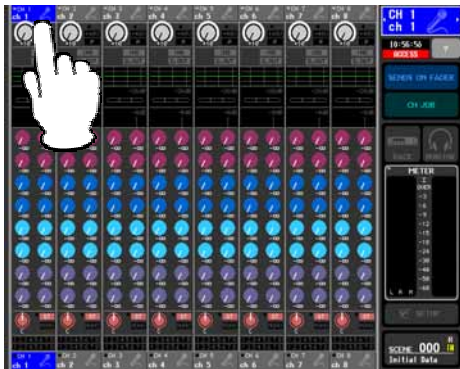

Press the channel number / channel name field of channel 1.



Select SLOT1.



Select port 1 of SLOT1.

The confirmation dialog will appear, then press [OK].



Port 1 of SLOT1 has been assigned to Input channel 1. Assign other slot in ports as shown below using the same way.

*Input patching by loading SB168-ES.M7C session file
 Input port 1-16 of SLOT1 - Input channels 1-16
 Input port 1-16 of SLOT2 - Input channels 17-32
 Input port 1-16 of SLOT3 - Input channels 33-48*

Output patching

Output patching can also be changed as desired.

This example explains how to patch MIX, STEREO, and MATRIX channels to slot out ports manually.



For MIX channels:

Press MIX 1-8 button of the Navigation keys.

Press the channel number / channel name field of MIX 1.

Select SLOT1 and then select Port 1 of SLOT1.

Assign other MIX channels in the same way.



For STEREO channels:

Press STEREO button of the Navigation keys.

Press the channel number / channel name field of STEREO L.

Select SLOT 1 and then select Port 7 of SLOT1.

Assign STEREO R to port 8 of SLOT1 in the same way.



For MATRIX channels:

Press MATRIX button of the Navigation keys.

Press the channel number / channel name field of MATRIX 1.

Select SLOT 2 and then select Port 1 of SLOT2.

Assign other MATRIX channels in the same way.

*Output patching by loading SB168-ES.M7C session file
 MIX 1-6, STEREO L/R – Output port 1-8 of SLOT1
 MIX 7-12, STEREO L/R – Output port 9-16 of SLOT1
 MATRIX 1-6, STEREO L/R – Output port 1-8 of SLOT2*

Appendix D: Manual patch of EtherSound

The Quick Setup function of the AVS-ESMonitor supports up to four SB168-ES units connected to an MY16-ES64. (In the case of PM5D, DM2000 or DME64N). However, if any other Ethersound devices are present in the network, Quick Setup cannot be used.

To edit a network created with Quick Setup or patch a more complex setup including other devices, please refer to the Yamaha "EtherSound Setup Guide" at the Yamaha Pro Audio website SB168-ES product page:

<http://www.yamahaproaudio.com/products/>

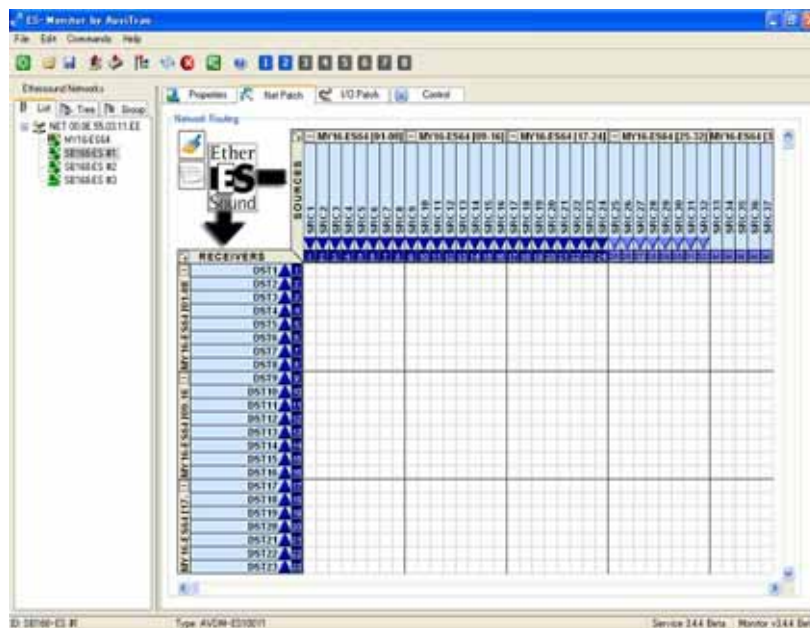
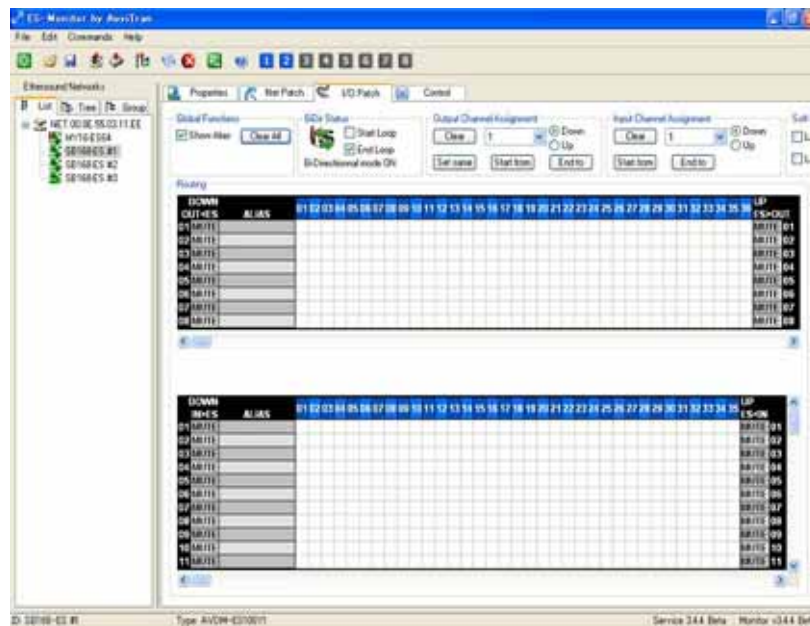

Appendix E: Manual setting of Remote HA

HA parameters, such as the phantom power (+48V) and gain, of SB168-ES units can be remotely controlled by performing the following procedures on the M7CL.

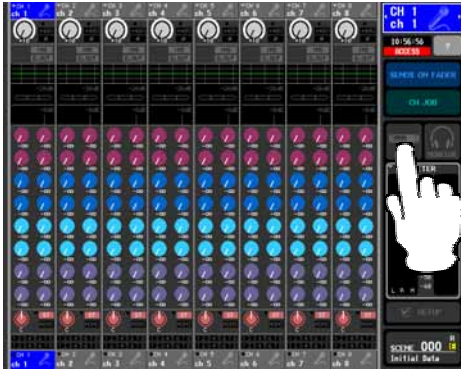

Press the RACK button to access the VIRTUAL RACK window.

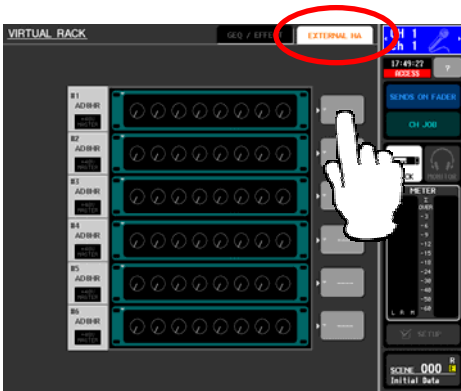

Press the EXTERNAL HA tab to display the EXTERNAL HA field, and then press the EXTERNAL HA PORT SELECT popup button.

Note: Three SB168-ES units are displayed as six AD8HRs on the screen.



Using the PORT SELECT buttons, select the input ports to which the external HA (SB168-ES) is connected in groups of 8 channels.

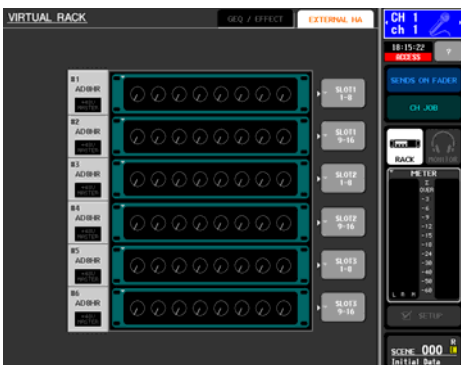

Remote HA setting by loading SB168-ES.M7C session file
 HA ID #1 – SB168-ES #1 Ch1-8 (Slot1 1-8)
 HA ID #2 – SB168-ES #1 Ch9-16 (Slot1 9-16)
 HA ID #3 – SB168-ES #2 Ch1-8 (Slot2 1-8)
 HA ID #4 – SB168-ES #2 Ch9-16 (Slot2 9-16)
 HA ID #5 – SB168-ES #3 Ch1-8 (Slot3 1-8)
 HA ID #6 – SB168-ES #3 Ch9-16 (Slot3 9-16)

Appendix F: Assigning stagebox patch to existing SCENES

If you are an experienced M7CL user and you have pre-existing SCENES saved in your console or on a USB stick, you will find that loading these sessions and recalling these SCENES will recall the patching that was used when they were created. If the SCENES were created before the addition of SB168-ES, then they will not suit your new SB168-ES remote stagebox system.

This appendix explains a method using the “Focus” feature to change the patch information in existing SCENES.

This section shows a short-cut method to insert one SCENE into another session without using Studio Manager. Alternatively, if you prefer, you can do this with Studio Manager by dragging the SCENE from a second open instance of M7CL Editor.



1. Backup your console session to a USB key.

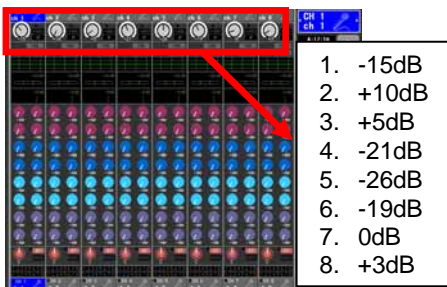

2. Make a note of HA values as these are not copied from AD IN to SB168 HA.



3. Load up the Pre-patched SB168-ES.M7C session.



4. In the SCENE page, copy the SB168-ES SCENE to the Copy buffer (As if you were going to copy and paste a SCENE).



5. Reload your Saved session.



6. Paste the stored SB168-ES SCENE to a vacant position in your SCENE LIST.

This section assigns HA remote control information to specified remote units. (Note that SB168-ES appears as two AD8HR units.)

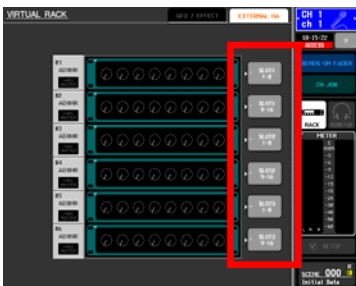

7. Open the Rack page and go to the External HA tab. Use the External HA Port Select button to assign all the displayed HA controllers to the slots. (This setup is not part of SCENE MEMORY and is set for all SCENES.)

This section moves the SB168-ES patch from the standard downloaded SCENE and applies it to your pre-existing SCENE using the "Focus method".



8. Open the SCENE page and Focus tab.



9. In the SCENE requiring the SB168 patch, change focus from [ALL] to [RACK] [HA] [IN] [OUT] [With Send].



10. Recall the SB168 patch SCENE. (This recalls the IN and OUT patches.)



11. Recall the SCENE needing the SB168 patch. (IN and OUT patches are not recalled because of focus, the SB168 patches is used.)

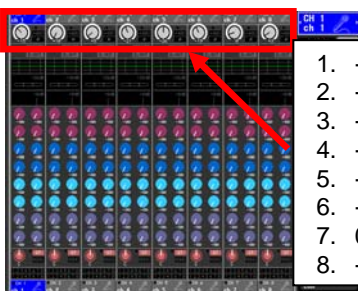

1. -15dB
2. +10dB
3. +5dB
4. -21dB
5. -26dB
6. -19dB
7. 0dB
8. +3dB

12. Copy HA noted in step 2 to HA of SB168 manually.



13. Re-store the SCENE with this new patch.



14. Return Focus setting to [ALL].

Appendix G: Using the Ring setting in Quick Setup

EtherSound data flows bi-directionally in a daisy chain. If the last device in the daisy chain is connected to the first, a ring is formed and data has a choice of directions to reach its destination. This provides a fault tolerant or redundant system that can survive a cable fault. However, special setup is required to apply ring patching and prevent EtherSound data traveling endlessly around the loop and causing a network crash or audio crackles.

Choosing [Ring] at this stage applies this special setup so that you can link the last device to the first and have a cable redundant system.

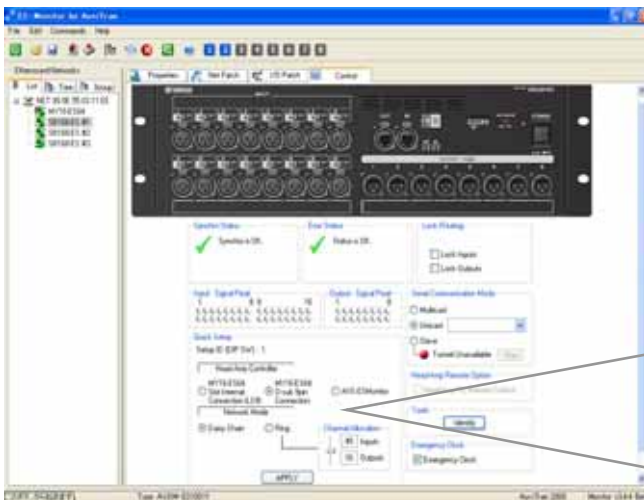

In the Quick Setup area

- Select [MY16-ES64 D-sub 9pin Connection].
- Select [Ring].
- Click the [APPLY] button.

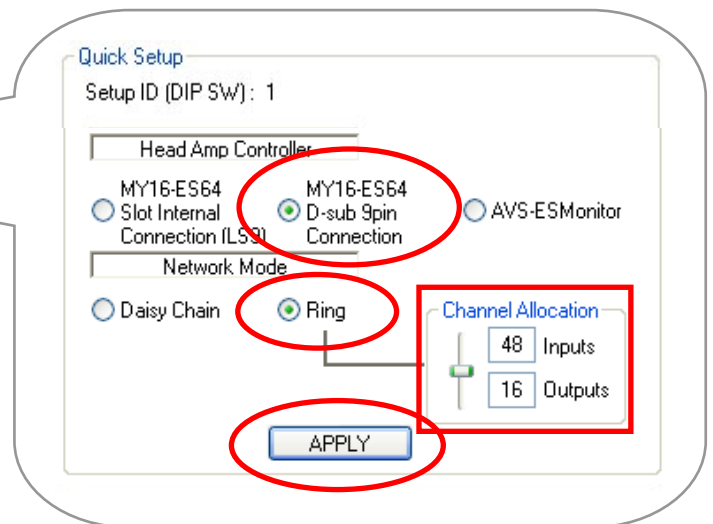

After the confirm box is checked all the network patching is done. HA control routing is setup and all information is saved to the EtherSound devices so they will remember after AVS-ESMonitor is disconnected or the power is cycled.

In Ring redundancy mode the total audio channel count is limited to 64. (In daisy chain mode it is 64 each direction =128) So a configuration of 48 inputs and 24 outputs (=72) is too high. Use the Channel Allocation slider to allow more input or output channels at the expense of the other.

For further information on the use of Ring mode, please refer to the Yamaha "EtherSound Setup Guide" at the Yamaha Pro Audio website SB168-ES product page:

<http://www.yamahaproaudio.com/products/>