

RX-V661

AV Receiver

Ampli-tuner audio-vidéo

OWNER'S MANUAL
MODE D'EMPLOI
BEDIENUNGSANLEITUNG
BRUKSANVISNING
GEBRUIKSAANWIJZING
ИНСТРУКЦИЯ ПО ЭКСПЛУАТАЦИИ

Caution: Read this before operating your unit.

- 1 To assure the finest performance, please read this manual carefully. Keep it in a safe place for future reference.
- 2 Install this sound system in a well ventilated, cool, dry, clean place – away from direct sunlight, heat sources, vibration, dust, moisture, and/or cold. Allow ventilation space of at least 30 cm on the top, 20 cm on the left and right, and 20 cm on the back of this unit.
- 3 Locate this unit away from other electrical appliances, motors, or transformers to avoid humming sounds.
- 4 Do not expose this unit to sudden temperature changes from cold to hot, and do not locate this unit in an environment with high humidity (i.e. a room with a humidifier) to prevent condensation inside this unit, which may cause an electrical shock, fire, damage to this unit, and/or personal injury.
- 5 Avoid installing this unit where foreign objects may fall onto this unit and/or this unit may be exposed to liquid dripping or splashing. On the top of this unit, do not place:
 - Other components, as they may cause damage and/or discoloration on the surface of this unit.
 - Burning objects (i.e. candles), as they may cause fire, damage to this unit, and/or personal injury.
 - Containers with liquid in them, as they may fall and liquid may cause electrical shock to the user and/or damage to this unit.
- 6 Do not cover this unit with a newspaper, tablecloth, curtain, etc. in order not to obstruct heat radiation. If the temperature inside this unit rises, it may cause fire, damage to this unit, and/or personal injury.
- 7 Do not plug in this unit to a wall outlet until all connections are complete.
- 8 Do not operate this unit upside-down. It may overheat, possibly causing damage.
- 9 Do not use force on switches, knobs and/or cords.
- 10 When disconnecting the power cable from the wall outlet, grasp the plug; do not pull the cable.
- 11 Do not clean this unit with chemical solvents; this might damage the finish. Use a clean, dry cloth.
- 12 Only voltage specified on this unit must be used. Using this unit with a higher voltage than specified is dangerous and may cause fire, damage to this unit, and/or personal injury. Yamaha will not be held responsible for any damage resulting from use of this unit with a voltage other than specified.
- 13 To prevent damage by lightning, keep the power cord and outdoor antennas disconnected from a wall outlet or the unit during a lightning storm.
- 14 Do not attempt to modify or fix this unit. Contact qualified Yamaha service personnel when any service is needed. The cabinet should never be opened for any reasons.
- 15 When not planning to use this unit for long periods of time (i.e. vacation), disconnect the AC power plug from the wall outlet.
- 16 Install this unit near the AC outlet and where the AC power plug can be reached easily.
- 17 Be sure to read the “Troubleshooting” section on common operating errors before concluding that this unit is faulty.
- 18 Before moving this unit, press MASTER ON/OFF to release it outward to the OFF position to turn off this unit, and then disconnect the AC power plug from the AC wall outlet.

- 19 **VOLTAGE SELECTOR** (Asia and General models only)
The VOLTAGE SELECTOR on the rear panel of this unit must be set for your local main voltage BEFORE plugging into the AC wall outlet. Voltages are:
 - Asia model 220/230–240 V AC, 50/60 Hz
 - General model 110/120/220/230–240 V AC, 50/60 Hz
- 20 The batteries shall not be exposed to excessive heat such as sunshine, fire or like.

WARNING

TO REDUCE THE RISK OF FIRE OR ELECTRIC SHOCK, DO NOT EXPOSE THIS UNIT TO RAIN OR MOISTURE.

As long as this unit is connected to the AC wall outlet, it is not disconnected from the AC power source even if you turn off this unit by MASTER ON/OFF. In this state, this unit is designed to consume a very small quantity of power.

■ For U.K. customers

If the socket outlets in the home are not suitable for the plug supplied with this appliance, it should be cut off and an appropriate 3 pin plug fitted. For details, refer to the instructions described below.

Note

The plug severed from the mains lead must be destroyed, as a plug with bared flexible cord is hazardous if engaged in a live socket outlet.

■ Special Instructions for U.K. Model

IMPORTANT

THE WIRES IN MAINS LEAD ARE COLOURED IN ACCORDANCE WITH THE FOLLOWING CODE:

Blue: NEUTRAL
Brown: LIVE

As the colours of the wires in the mains lead of this apparatus may not correspond with the coloured markings identifying the terminals in your plug, proceed as follows:

The wire which is coloured BLUE must be connected to the terminal which is marked with the letter N or coloured BLACK. The wire which is coloured BROWN must be connected to the terminal which is marked with the letter L or coloured RED.

Making sure that neither core is connected to the earth terminal of the three pin plug.



This symbol mark is according to the EU directive 2002/96/EC.

This symbol mark means that electrical and electronic equipment, at their end-of-life, should be disposed of separately from your household waste.

Please act according to your local rules and do not dispose of your old products with your normal household waste.

Contents

INTRODUCTION

Notice	2
Features	3
Supplied accessories	3
Getting started	4
Quick start guide	5

PREPARATION

Connections	11
Optimizing the speaker setting for your listening room	28
Using AUTO SETUP	28

BASIC OPERATION

Selecting the SCENE templates.....	33
Selecting the desired SCENE template.....	33
Creating your original SCENE templates.....	36
Playback	37
Basic procedure	37
Selecting the MULTI CH INPUT component.....	38
Selecting the front speaker set	38
Selecting audio input jacks (AUDIO SELECT).....	39
Displaying the current status of this unit on a video monitor	39
Using your headphones.....	40
Muting the audio output.....	40
Playing video sources in the background of an audio source.....	40
Displaying the input source information	40
Using the sleep timer	41
Sound field programs.....	42
Selecting sound field programs	42
Sound field program descriptions	42
Enjoying unprocessed input sources (Straight decoding mode).....	47
Using audio features	48
Enjoying pure hi-fi sound	48
Adjusting the tonal quality.....	48
Adjusting the speaker level.....	48
Enjoying multi-channel sources in 2-channel stereo	49
Selecting the night listening mode.....	49
FM/AM tuning.....	50
Automatic tuning	50
Manual tuning.....	50
Automatic preset tuning.....	51
Manual preset tuning	51
Selecting preset stations.....	52
Exchanging preset stations	52
Radio Data System tuning (Europe model only)	53
Displaying the Radio Data System information	53
Selecting the Radio Data System program type (PTY SEEK mode).....	54
Using the enhanced other networks (EON) data service	55
Using iPod™.....	56
Controlling iPod™.....	56
Recording	58

ADVANCED OPERATION

Advanced sound configurations.....	59
Changing sound field parameter settings.....	59
Selecting decoders	64
Customizing this unit (MANUAL SETUP).....	67
Using SET MENU	69
1 SOUND MENU.....	70
2 INPUT MENU.....	76
3 OPTION MENU	79
Remote control features.....	82
Using the remote control for the SCENE feature	82
Controlling this unit, a TV, or other components.....	83
Setting remote control codes	85
Programming codes from other remote controls	87
Changing source names in the display window.....	88
Macro programming features	89
Clearing configurations	92
Using multi-zone configuration.....	95
Connecting Zone 2.....	95
Controlling Zone 2.....	96
Advanced setup.....	98
Using the advanced setup	98

ADDITIONAL INFORMATION

Troubleshooting.....	102
Resetting the system.....	109
Glossary.....	110
Sound field program information.....	112
Parametric equalizer information	113
Specifications	114
Index	116

APPENDIX

(at the end of this manual)

Front panel.....	i
Remote control	ii
List of remote control codes	iii

“①SPEAKERS” or “④DVD” (example) indicates the name of the parts on the front panel or the remote control. Refer to the attached sheet or the pages at the end of this manual for the information about each position of the parts.

INTRODUCTION

PREPARATION

BASIC OPERATION

ADVANCED OPERATION





ADDITIONAL INFORMATION

APPENDIX

English

Notice

About this manual

-  indicates a tip for your operation.
- Some operations can be performed by using either the buttons on the front panel or the ones on the remote control. In case the button names differ between the front panel and the remote control, the button name on the remote control is given in parentheses.
- This manual is printed prior to production. Design and specifications are subject to change in part as a result of improvements, etc. In case of differences between the manual and product, the product has priority.
- “SPEAKERS” or “DVD” (example) indicates the name of the parts on the front panel or the remote control. Refer to the attached sheet or the pages at the end of this manual for the information about each position of the parts.
- The symbol “” with page number(s) indicates the corresponding reference page(s).



Manufactured under license from Dolby Laboratories.

“Dolby”, “Pro Logic”, and the double-D symbol are trademarks of Dolby Laboratories.



DTS-ES | NEO:6 | 96/24. Product “DTS” and “DTS-ES | NEO:6” are registered trademarks of DTS, Inc.

“96/24” is a trademark of DTS, Inc.

iPod™

“iPod” is a trademark of Apple Computer, Inc., registered in the U.S. and other countries.



“HDMI”, the “HDMI” logo and “High-Definition Multimedia Interface” are trademarks or registered trademarks of HDMI Licensing LLC.

SILENT™
CINEMA

“SILENT CINEMA” is a trademark of YAMAHA CORPORATION.

Features

Built-in 7-channel power amplifier

- ◆ Minimum RMS output power (20 Hz to 20 kHz, 0.06% THD, 8 Ω)
Front: 90 W + 90 W
Center: 90 W
Surround: 90 W + 90 W
Surround back: 90 W + 90 W

SCENE function

- ◆ 17 preset SCENE templates for various situations
- ◆ 4 original SCENE templates for customizing capability
- ◆ Controlling Yamaha SCENE control signal support component (some models only) working with the SCENE function

Sound field programs

- ◆ Proprietary Yamaha technology for the creation of sound fields
- ◆ Compressed Music Enhancer mode to improve the sound quality of compression artifacts (such as the MP3 format) to that of a high-quality stereo
- ◆ Dolby Digital/Dolby Digital EX decoder
- ◆ DTS/DTS-ES Matrix, Discrete, DTS Neo:6, DTS 96/24 decoder
- ◆ Dolby Pro Logic/Dolby Pro Logic II/Dolby Pro Logic IIx decoder
- ◆ Virtual CINEMA DSP
- ◆ SILENT CINEMA

Sophisticated FM/AM tuner

- ◆ 40-station random and direct preset tuning
- ◆ Automatic preset tuning
- ◆ Preset station shifting capability (preset editing)
- ◆ Radio Data System capability (Europe model only)

HDMI (High-Definition Multimedia Interface)

- ◆ HDMI interface for standard, enhanced or high-definition video (includes 1080p video signal transmission) as well as multi-channel digital audio based on HDMI version 1.2a

iPod controlling capability

- ◆ DOCK terminal to connect a Yamaha iPod universal dock (such as the YDS-10, sold separately), which supports iPod (Click and Wheel), iPod nano, and iPod mini
- ◆ Playback information displaying capability
- ◆ Battery charging capability

Other features

- ◆ YPAO (Yamaha Parametric Room Acoustic Optimizer) for automatic speaker setup
- ◆ 192-kHz/24-bit D/A converter
- ◆ OSD (on-screen display) menus that allow you to optimize this unit to suit your individual audiovisual system
- ◆ 5.1 or 7.1-channel additional input jacks for discrete multi-channel input
- ◆ S-video signal input/output capability
- ◆ Component video input/output capability includes (3 COMPONENT VIDEO INs and 1 MONITOR OUT)
- ◆ Digital video signal conversion (composite video ↔ S-video → component video) capability for monitor out
- ◆ Optical and coaxial digital audio signal jacks
- ◆ Pure Direct mode for pure hi-fi sound for all sources
- ◆ Cinema and music night listening modes
- ◆ Remote control with preset remote control codes capability
- ◆ Zone 2 custom installation facility
- ◆ Zone switching capability between the main zone and Zone 2 using ZONE CONTROL
- ◆ Bi-amplification connection capability
- ◆ Sleep timer

Supplied accessories

Check that you received all of the following parts.

Remote control



Batteries (4)
(AAA, R03, UM-4)

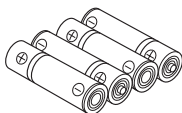

AM loop antenna



Optimizer microphone



Indoor FM antenna

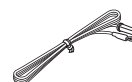

Note

The form of the supplied accessories varies depending on the models.

Getting started

■ Installing batteries in the remote control

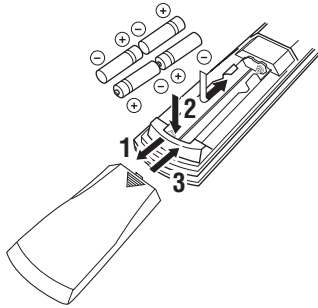

- 1 Press the ▼ part and slide the battery compartment cover off.**
- 2 Insert the four supplied batteries (AAA, R03, UM-4) according to the polarity markings (+ and -) on the inside of the battery compartment.**
- 3 Slide the cover back until it snaps into place.**

Notes

- Change all of the batteries if you notice the following conditions:
 - the operation range of the remote control decreases.
 - the transmit indicator (⊗) does not flash or its light becomes dim.
- Do not use an old battery together with a new one.
- Do not use different types of batteries (such as alkaline and manganese batteries) together. Read the packaging carefully as these different types of batteries may have the same shape and color.
- If the batteries have leaked, dispose of them immediately. Avoid touching the leaked material or letting it come into contact with clothing, etc. Clean the battery compartment thoroughly before installing new batteries.
- Do not throw away batteries with general house waste; dispose of them correctly in accordance with your local regulations.
- If the remote control is without batteries for more than 2 minutes, or if exhausted batteries remain in the remote control, the contents of the memory may be cleared. When the memory is cleared, insert new batteries, set up the remote control code and program any acquired functions that may have been cleared.

■ VOLTAGE SELECTOR (Asia and General models only)

Caution

The VOLTAGE SELECTOR on the rear panel of this unit must be set for your local voltage BEFORE plugging the power cable into the AC wall outlet. Improper setting of the VOLTAGE SELECTOR may cause damage to this unit and create a potential fire hazard.

Rotate the VOLTAGE SELECTOR clockwise or counterclockwise to the correct position using a straight slot screwdriver.

Voltages are as follows:

Asia model

..... 220/230–240 V AC, 50/60 Hz

General model

..... 110/120/220/230–240 V AC, 50/60 Hz

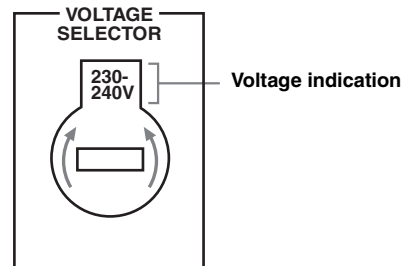

Quick start guide

The following steps describe the easiest way to enjoy DVD movie playback in your home theater.

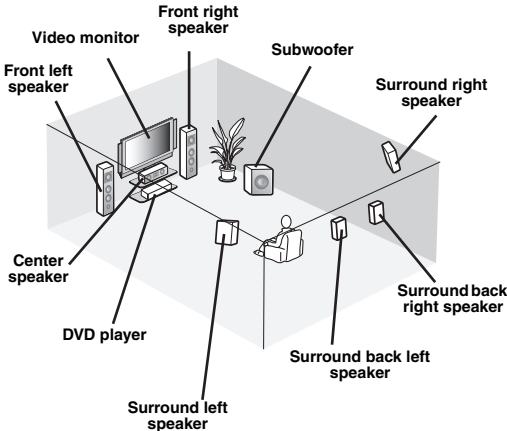

Step 1: Set up your speakers

P. 6

Step 2: Connect your DVD player and other components

P. 7

Step 3: Turn on the power and press SCENE 1 button

P. 9

Enjoy DVD playback!

Preparation: Check the items

In these steps, you need the following supplied accessories.

- AM loop antenna
- Indoor FM antenna

The following items are not included in the package of this unit.

- Speakers**
 - Front speakers 2
 - Center speaker 1
 - Surround speakers 4

Select magnetically shielded speakers. The minimum required speakers are two front speakers. The priority of the requirement of other speakers is as follows:

 1. Two surround speakers
 2. Center speaker
 3. One (or two) surround back speaker(s)
- Active subwoofer** 1
Select an active subwoofer equipped with an RCA input jack.
- Speaker cables** 7
- Subwoofer cable** 1
Select a monaural RCA cable.
- DVD player** 1
Select DVD player equipped with coaxial digital audio output jack and composite video output jack.
- Video monitor** 1
Select a TV monitor, video monitor or projector equipped with a composite video input jack.
- Video cable** 1
Select an RCA composite video cable.
- Digital coaxial audio cable** 1

Step 1: Set up your speakers

Place your speakers in the room and connect them to this unit.

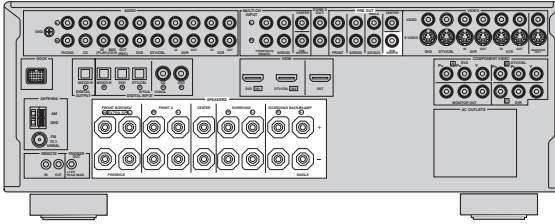

1 Place your speakers and subwoofer in the room.

2 Connect speaker cables to each speaker.

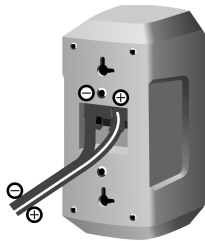

Be sure to connect the “+” (red) and “-” (black) properly. Cables are colored or shaped differently, perhaps with a stripe, groove or ridge. Connect the striped (grooved, etc.) cable to the “+” (red) terminals of this unit and your speaker. Connect the plain cable to the “-” (black) terminals.

3 Connect each speaker cable to the corresponding speaker terminal of this unit.

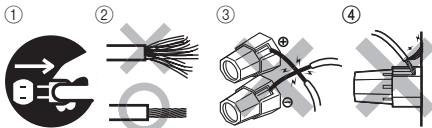

- ① Make sure that this unit and the subwoofer are unplugged from the AC wall outlets.
- ② Twist the exposed wires of the speaker cables together to prevent short circuits.
- ③ Do not let the bare speaker wires touch each other.
- ④ Do not let the bare speaker wires touch any metal part of this unit.

Be sure to connect the left channel (L), right channel (R), “+” (red) and “-” (black) properly.

Front speakers and center speaker

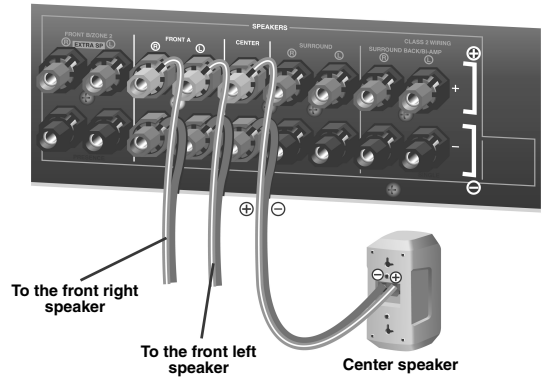
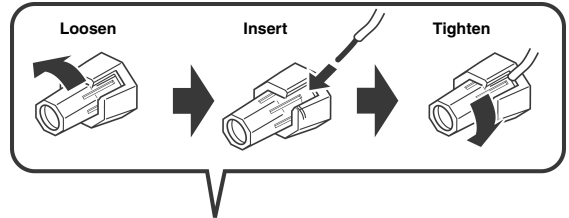

Surround and surround back speakers

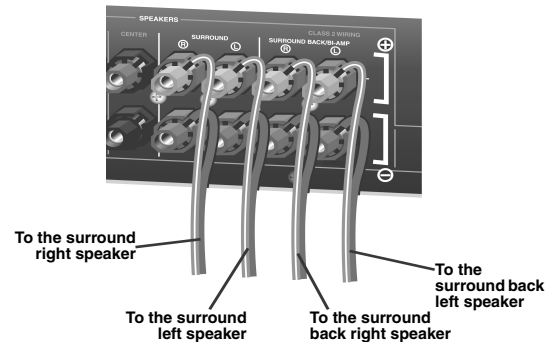

5 Connect the subwoofer cable to the SUBWOOFER PRE OUT jack of this unit and the input jack of the subwoofer.

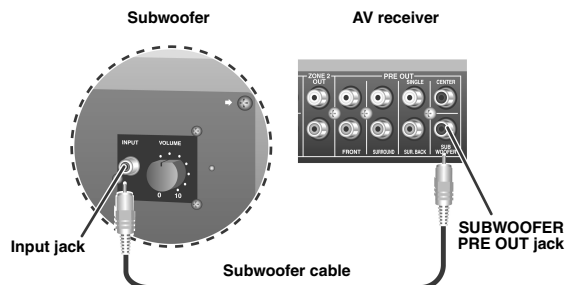

Step 2: Connect your DVD player and other components

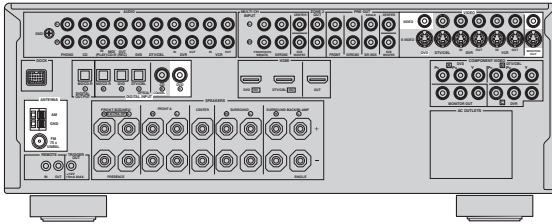

Make sure that this unit and the DVD player are unplugged from the AC wall outlets.

- 1 Connect the digital coaxial audio cable to the digital coaxial audio output jack of your DVD player and the DVD COAXIAL jack of this unit.

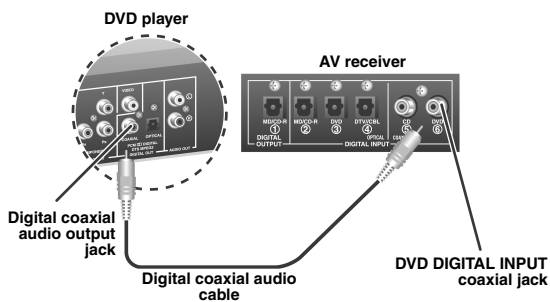

- 2 Connect the video cable to the composite video output jack of your DVD player and DVD VIDEO jack of this unit.

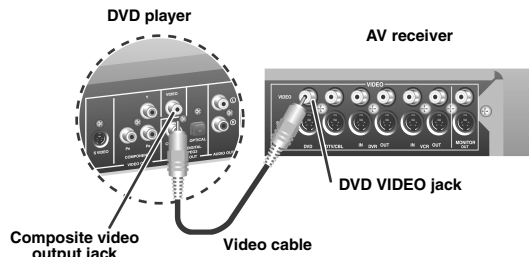

- 3 Connect the video cable to the VIDEO MONITOR OUT jack of this unit and the video input jack of your video monitor.

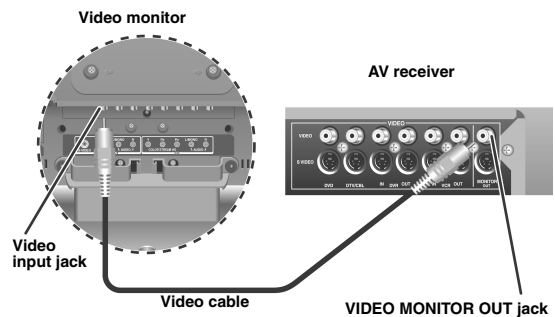

4 Connect the supplied AM loop antenna and indoor FM antenna to this unit.

See page 24 for the connection information.

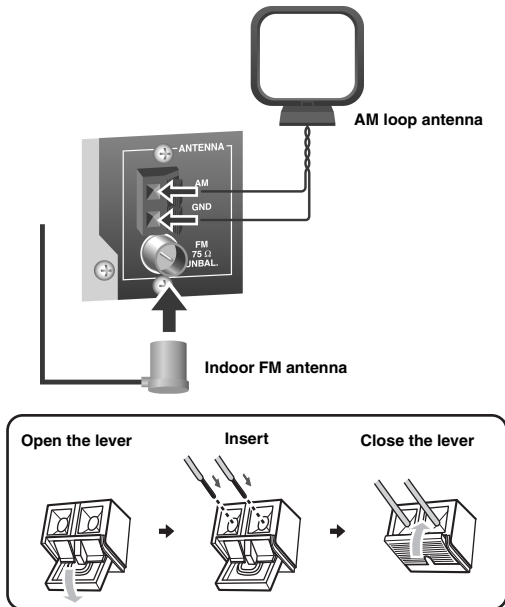

The wire of the AM loop antenna does not have any polarity and you can connect either end of the wire to AM or GND terminal

Assembling the supplied AM loop antenna

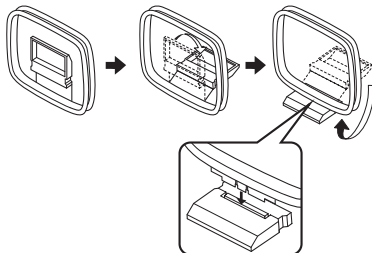

5 Connect the power plug of this unit and other components into the AC wall outlet.



This unit is equipped with AC OUTLET(S) for the power supply of the other components (except Korea model). See page 24 for details.

Note

The type of the power plug is different depending on the models.

For further connections

- Using the other kind of speaker combinations P. 12
- Connecting a video monitor via various ways of the connection P. 18
- Connecting a DVD player via various ways of the connection P. 19
- Connecting a DVD recorder or a digital video recorder P. 20
- Connecting a set-top box P. 20
- Connecting a CD player, an MD recorder or a turntable P. 21
- Connecting an external amplifier P. 22
- Connecting a DVD player via analog multi-channel audio connection P. 22
- Connecting a Yamaha iPod universal dock P. 23
- Using the REMOTE IN/OUT jacks P. 23
- Using the VIDEO AUX jacks on the front panel P. 23
- Connecting an outdoor FM/AM antenna P. 24

Step 3: Turn on the power and press SCENE 1 button

Check the type of the connected speakers.

If the speakers are 6 ohm speakers, set “SP IMP.” to “6Ω MIN” before using this unit (see page 25). 4 ohm speakers can be also used as the front speakers (see page 99).

- 1 Turn on the video monitor connected to this unit.

- 2 Press **Ⓜ** MASTER ON/OFF inward to the ON position on the front panel.



- 3 Press **Ⓛ** SCENE1 button.

“DVD Movie Viewing” appears in the front panel display, and this unit automatically optimize own status for the DVD playback.



The indicator on the selected SCENE button lights up while this unit is in the SCENE mode.

- 4 Start playback of the desired DVD on your player.



If the connected DVD player is a Yamaha product and has capability of the SCENE control signals with the REMOTE OUT jack of this unit (see page 23), this unit can automatically activate the DVD player and start playback when you press the **Ⓛ** SCENE1 button. Refer to the instruction manual of the DVD player for further information.

- 5 Rotate **Ⓥ** VOLUME to adjust the volume.



Note

When you change the input source or sound field program, the SCENE mode is deactivated, and the indicator on the selected SCENE button turns off.

■ Using the other SCENE buttons

In the following cases, try pressing the corresponding SCENE button to enjoy the playback of the desired sources.

Case A: “I want to listen to a music disc from the connected DVD player..”

➔ Press **Ⓛ** SCENE2 (or **Ⓐ** SCENE2) to select “Music Disc Listening”.

Case B: “I want to watch a TV program...”

➔ Press **Ⓛ** SCENE3 (or **Ⓐ** SCENE3) to select “TV Viewing”.

Case C: “I want to listen to a music program of the FM/AM radio station...”

➔ Press **Ⓛ** SCENE4 (or **Ⓐ** SCENE4) to select “Radio Listening”.

Notes

- To use the “TV Viewing” template (Case B), you must connect a satellite receiver, a cable TV receiver or an HDTV decoder to this unit in advance. See page 20 for details.
- To use the “Radio Listening” template (Case C), you have to tune into the desired radio station. See pages 50 to 52 for the tuning information.
- To achieve the best possible reception, orient the connected AM loop antenna, or adjust the position of the end of the indoor FM antenna.



If you cannot find the desired situation, you can select and change the assigned SCENE template for the SCENE buttons. See page 33 for details.

■ After using this unit...

Press **Ⓜ MAIN ZONE ON/OFF** to set this unit to the standby mode.



This unit is set to the standby mode and consumes a small amount of power in order to receive infrared signals from the remote control. To turn on this unit from the standby mode, press the desired **Ⓢ SCENE** buttons (or **Ⓐ SCENE**) or **Ⓜ MAIN ZONE ON/OFF** on the front panel (or **Ⓟ POWER** on the remote control). See page 25 for details.

What do you want to do with this unit?

■ Customizing the SCENE templates

- Using various SCENE templates ☞ P. 33
- Creating your original SCENE templates ☞ P. 36

■ Using various input sources

- Basic controls of this unit ☞ P. 37
- Enjoying FM/AM radio programs ☞ P. 50
- Using your iPod with this unit ☞ P. 56

■ Using various sound features

- Using various sound field programs ☞ P. 42
- Using the pure direct mode for high fidelity sound ☞ P. 48
- Customizing the sound field programs ☞ P. 59

■ Adjusting the parameters of this unit

- Automatically optimizing the speaker parameters for your listening room (AUTO SETUP) ☞ P. 28
- Manually adjusting various parameters of this unit manually ☞ P. 69
- Setting the remote control ☞ P. 82
- Adjusting the advanced parameters ☞ P. 98

■ Additional features

Automatically turning off this unit

☞ P. 41

Connections

Rear panel

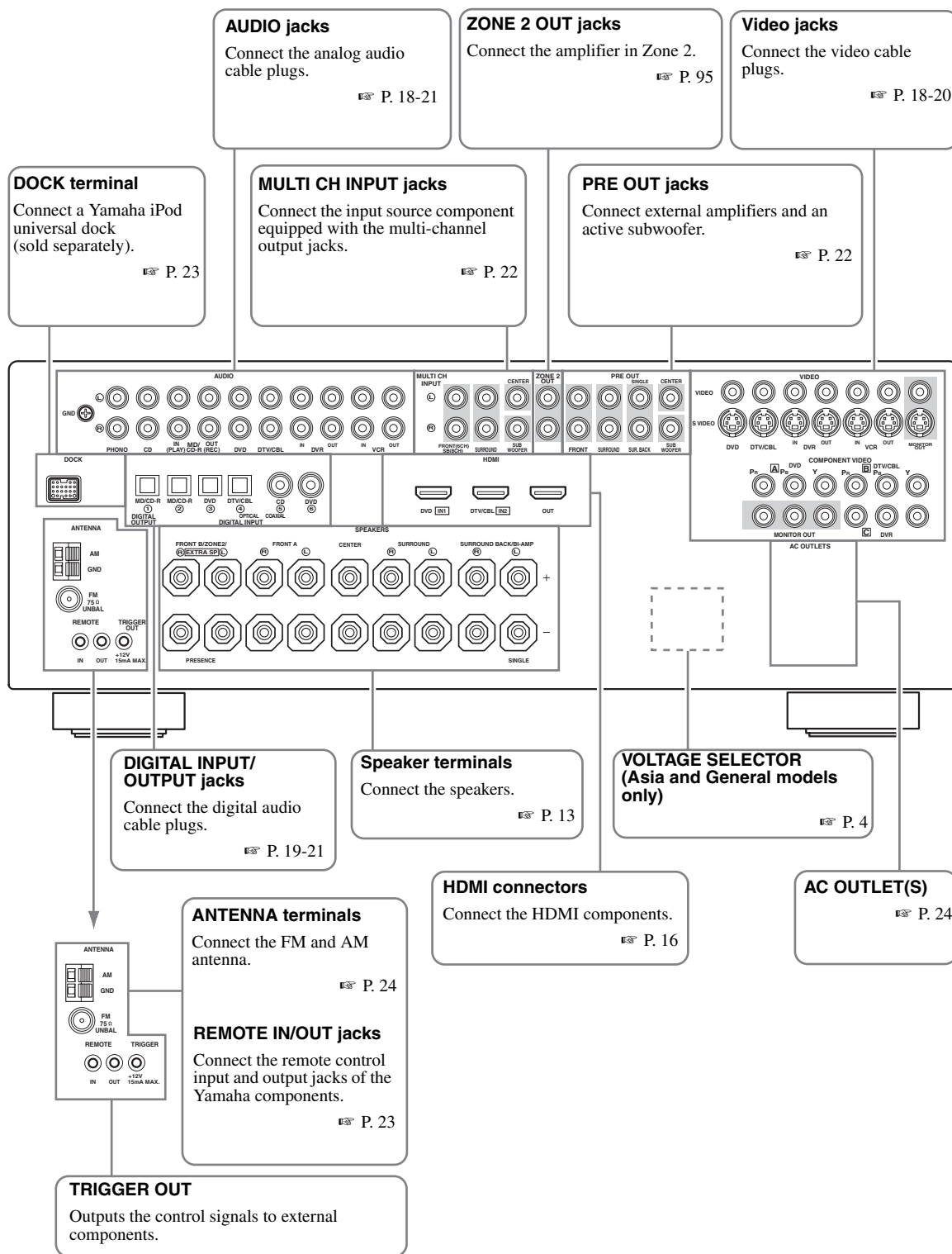

Placing speakers

The speaker layout below shows the speaker setting we recommend. You can use it to enjoy CINEMA DSP and multi-channel audio sources.

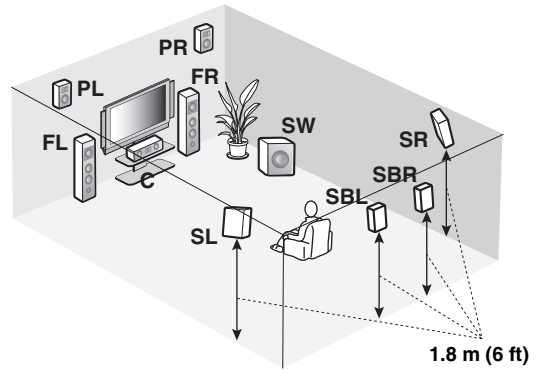
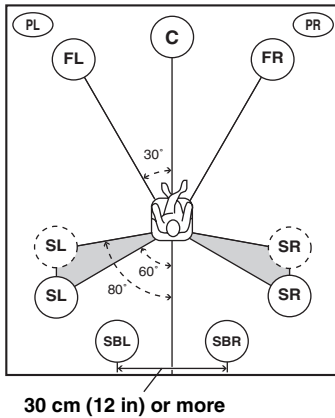

Front left and right speakers (FL and FR)

The front speakers are used for the main source sound plus effect sounds. Place these speakers at an equal distance from the ideal listening position. The distance of each speaker from each side of the video monitor should be the same.

Center speaker (C)

The center speaker is for the center channel sounds (dialog, vocals, etc.). If for some reason it is not practical to use a center speaker, you can do without it. Best results, however, are obtained with the full system.

Surround left and right speakers (SL and SR)

The surround speakers are used for effect and surround sounds.

Surround back left and right speakers (SBL and SBR)

The surround back speakers supplement the surround speakers and provide more realistic front-to-back transitions.

Presence left and right speakers (PL and PR)

The presence speakers supplement the sound from the front speakers with extra ambient effects produced by the sound field programs (see page 42). To use the presence speakers, connect the speakers to EXTRA SP terminals and then set "EXTRA SP ASSIGN" to "PRESENCE" (see pages 29 and 70).

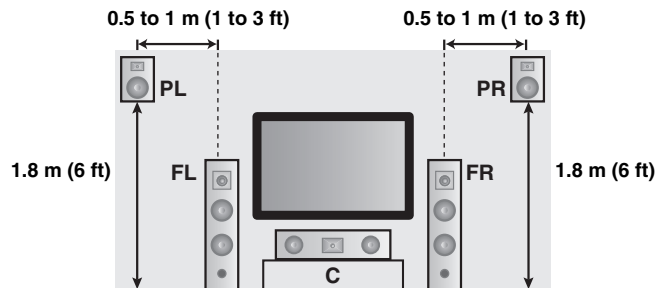

Subwoofer (SW)

The use of a subwoofer with a built-in amplifier, such as the Yamaha Active Servo Processing Subwoofer System, is effective not only for reinforcing bass frequencies from any or all channels, but also for high fidelity sound reproduction of the LFE (low-frequency effect) channel included in Dolby Digital and DTS sources. The position of the subwoofer is not so critical, because low bass sounds are not highly directional. But it is better to place the subwoofer near the front speakers. Turn it slightly toward the center of the room to reduce wall reflections.

Connecting speakers

Be sure to connect the left channel (L), right channel (R), “+” (red) and “-” (black) properly. If the connections are faulty, this unit cannot reproduce the input sources accurately.

Caution

- Before connecting the speakers, make sure that this unit is turned off (see page 25).
- Do not let the bare speaker wires touch each other or let them touch any metal part of this unit. This could damage this unit and/or the speakers. If the speaker wires are short-circuited, “CHECK SP WIRES” appears in the front panel display.
- Use the magnetically shielded speakers. If this type of speaker still creates interference with the monitor, place the speakers away from the monitor.
- If you are to use 6 ohm speakers, be sure to set “SP IMP.” to “6Ω MIN” before using this unit (see page 25). 4 ohm speakers can be also used as the front speakers (see page 99).

Note

A speaker cord is actually a pair of insulated cables running side by side. Cables are colored or shaped differently, perhaps with a stripe, groove or ridge. Connect the striped (grooved, etc.) cable to the “+” (red) terminals of this unit and your speaker. Connect the plain cable to the “-” (black) terminals.

EXTRA SP terminals

Connect the alternative front speaker system (FRONT B), presence speakers or Zone 2 speakers. To select the function of the speakers connected to the EXTRA SP terminals, set the “EXTRA SP ASSIGN” parameter in “SOUND MENU” (see page 70).



You can also select the function of the speakers connected to the EXTRA SP terminals in “AUTO SETUP” (see page 29).

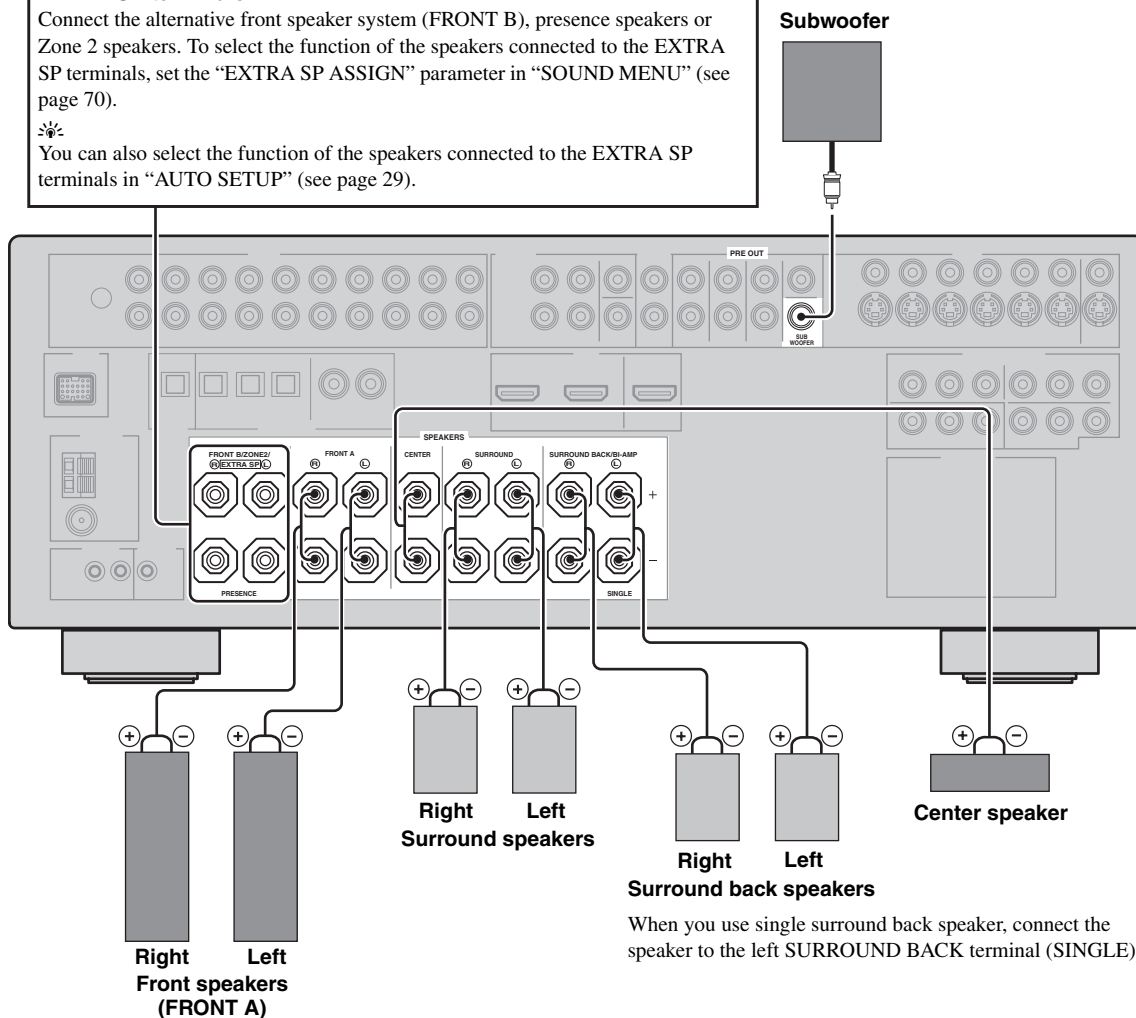

■ Connecting the speaker cable

- 1 Remove approximately 10 mm (0.4 in) of insulation from the end of each speaker cable and then twist the exposed wires of the cable together to prevent short circuits.

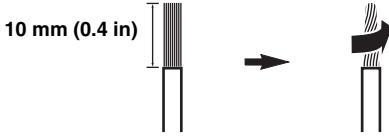

- 2 Loosen the knob.

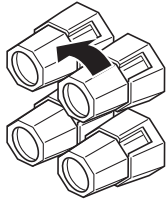

Red: positive (+)
Black: negative (-)

- 3 Insert one bare wire into the hole on the side of each terminal.

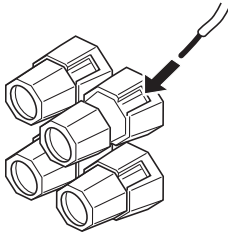

- 4 Tighten the knob to secure the wire.

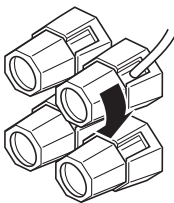

■ Connecting the banana plug (except Europe, Asia and Korea models)

Tighten the knob and then insert the banana plug connector into the end of the corresponding terminal.

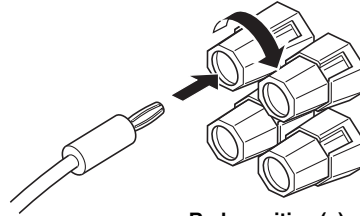

Red: positive (+)
Black: negative (-)

■ Using bi-amplification connections

Caution

Remove the shorting bars or bridges to separate the LPF (low pass filter) and HPF (high pass filter) crossovers.

This unit allows you to make bi-amplification connections to one speaker system. Check if your speakers support bi-amplification.

To make the bi-amplification connections, use the FRONT and SURROUND BACK terminals as shown below. To activate the bi-amplification connections, set “BI-AMP” to “ON” in “ADVANCED SETUP” (see page 101).

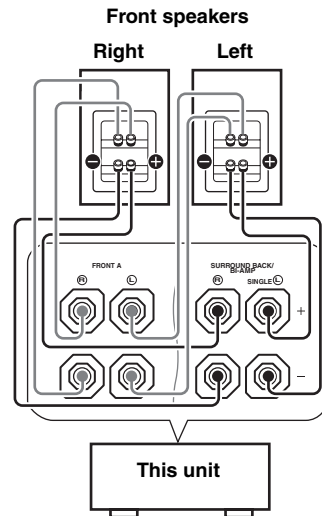

Note

When you make the conventional connection, make sure that the shorting bars are put into the terminals appropriately. Refer to the instruction manuals of the speakers for details.

Information on jacks and cable plugs

Audio jacks and cable plugs

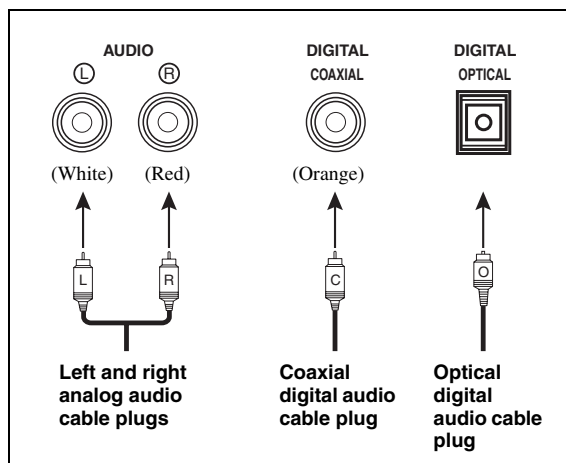

Video jacks and cable plugs

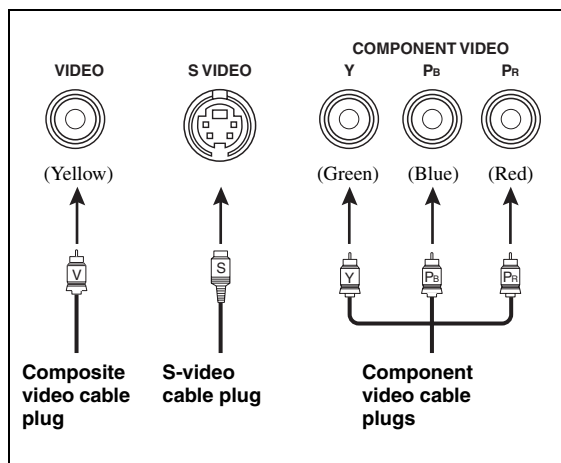

■ Audio jacks

This unit has three types of audio jacks. Connection depends on the availability of audio jacks on your other components.

AUDIO jacks

For conventional analog audio signals transmitted via left and right analog audio cables. Connect red plugs to the right jacks and white plugs to the left jacks.

DIGITAL COAXIAL jacks

For digital audio signals transmitted via coaxial digital audio cables.

DIGITAL OPTICAL jacks

For digital audio signals transmitted via optical digital audio cables.

Notes

- You can use the digital jacks to input PCM, Dolby Digital and DTS bitstreams. When you connect components to both the COAXIAL and OPTICAL jacks, priority is given to the signals input at the COAXIAL jack. All digital input jacks are compatible with digital signals with up to 96 kHz of sampling frequency.
- Pull out the cap from the optical jack before you connect the fiber optic cable. Do not discard the cap. When you are not using the optical jack, be sure to put the cap back in place. This cap protects the jack from dust.



■ Video jacks

This unit has three types of video jacks. Connection depends on the availability of input jacks on your video monitor.

VIDEO jacks

For conventional composite video signals transmitted via composite video cables.

S VIDEO jacks

For S-video signals, separated into the luminance (Y) and chrominance (C) video signals transmitted on separate wires of S-video cables.

COMPONENT VIDEO jacks

For component video signals, separated into the luminance (Y) and chrominance (P_B, P_R) video signals transmitted on separate wires of component video cables.



This unit is equipped with the video conversion function. See pages 17 and 79 for details.

Information on HDMI™

■ HDMI compatibility with this unit

Audio signal types	Audio signal formats	Compatible HDMI components
2ch Linear PCM	2ch, 32-192 kHz, 16/20/24 bit	CD, DVD-Video, DVD-Audio, etc.
Multi-ch Linear PCM	8ch, 32-192 kHz, 16/20/24 bit	DVD-Audio, etc.
DSD	2/5.1ch, 2.8224 MHz, 1 bit	SACD, etc.
Bitstream	Dolby Digital, DTS	DVD-Video, etc.

This unit's HDMI interface is based on the following standards:

- HDMI Version 1.2a (High-Definition Multimedia Interface Specification Version 1.2a) licensed by HDMI Licensing, LLC.
- HDCP Revision 1.1 (High-bandwidth Digital Content Protection System Revision 1.1) licensed by Digital Content Protection, LLC.

Notes

- When CPPM copy-protected DVD audio is played back, video and audio signals may not be output depending on the type of the DVD player.
- This unit is not compatible with HDCP-incompatible HDMI or DVI components.
- You can check the potential problem about the HDMI connection (see page 41).

■ HDMI jack and cable plug

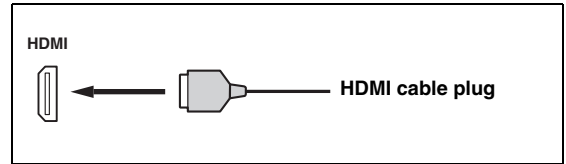

- We recommend using an HDMI cable shorter than 5 meters (16 feet) with the HDMI logo printed on it.
- Use a conversion cable (HDMI jack ↔ DVI-D jack) to connect this unit to other DVI components.

Notes

- Do not disconnect or connect the cable or turn off the power of the HDMI components connected to the HDMI OUT jack of this unit while data is being transferred. Doing so may disrupt playback or cause noise.
- Audio signals input at input jacks other than the HDMI IN 1 or HDMI IN 2 jack of this unit cannot be digitally output at the HDMI OUT jack.
- If you turn off the power of the video monitor connected to the HDMI OUT jack via a DVI connection, this unit may fail to establish the connection to the component.

Audio and video signal flow

Audio signal flow

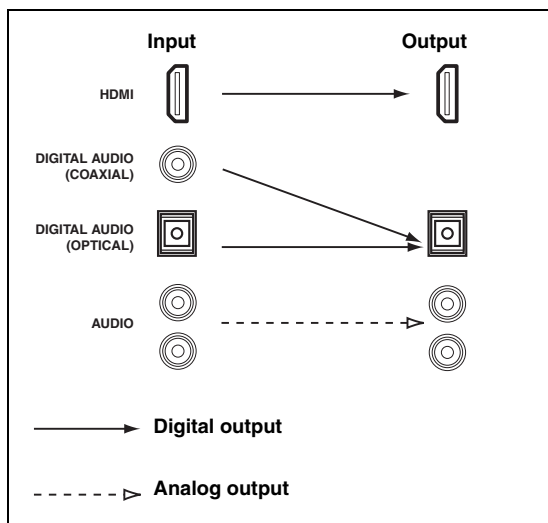

Notes

- 2-channel as well as multi-channel PCM, Dolby Digital and DTS signals input at the HDMI IN 1 or HDMI IN 2 jack can be output at the HDMI OUT jack only when "SUPPORT AUDIO" is set to "OTHER" (see page 75).
- Audio signals input at the HDMI IN jacks are not output at the AUDIO output and DIGITAL OUTPUT jacks.

Video signal flow

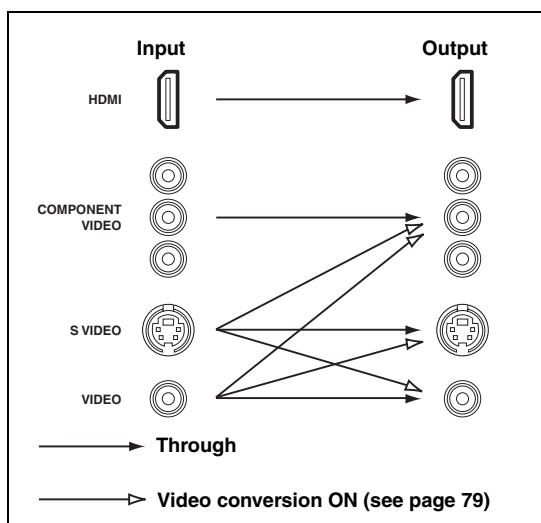

Notes

- When the analog video signals are input at the COMPONENT VIDEO, S VIDEO and VIDEO jacks, the priority order of the input signals is as follows:
 1. COMPONENT VIDEO
 2. S VIDEO
 3. VIDEO
- Digital video signals input at the HDMI IN 1 or HDMI IN 2 jack cannot be output from analog video output jacks.
- This unit does not accept analog component video signals with 1080p of resolution.
- The OSD signal is not output at the VCR OUT, DVR OUT and HDMI MONITOR OUT jacks and is not recorded.
- This unit does not deinterlace any analog video signals.

Connecting a TV monitor or projector

Connect your TV (or projector) to the HDMI OUT jack, the COMPONENT VIDEO MONITOR OUT jacks, the S VIDEO MONITOR OUT jack or the VIDEO MONITOR OUT jack of this unit.



Make sure that this unit and other components are unplugged from the AC wall outlets.



You can choose to play back HDMI audio signals on this unit or on another HDMI component connected to the HDMI OUT jack of this unit. Use the "SUPPORT AUDIO" parameter in "SOUND MENU" to select the component to play back HDMI audio signals (see page 75).

Notes

- Some video monitors connected to this unit via a DVI connection fail to recognize the HDMI audio/video signals being input if they are in the standby mode. In this case, the HDMI indicator flashes irregularly.
- When you connect your TV monitor or projector via HDMI connection, the OSD does not appear. In such cases, connect the TV monitor or projector via component, S-video or video connection.
- Connect the input source components to the HDMI IN 1 or HDMI IN 2 jack to display the video images on the video monitor connected to the HDMI OUT jack.

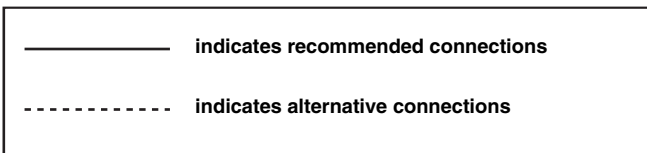
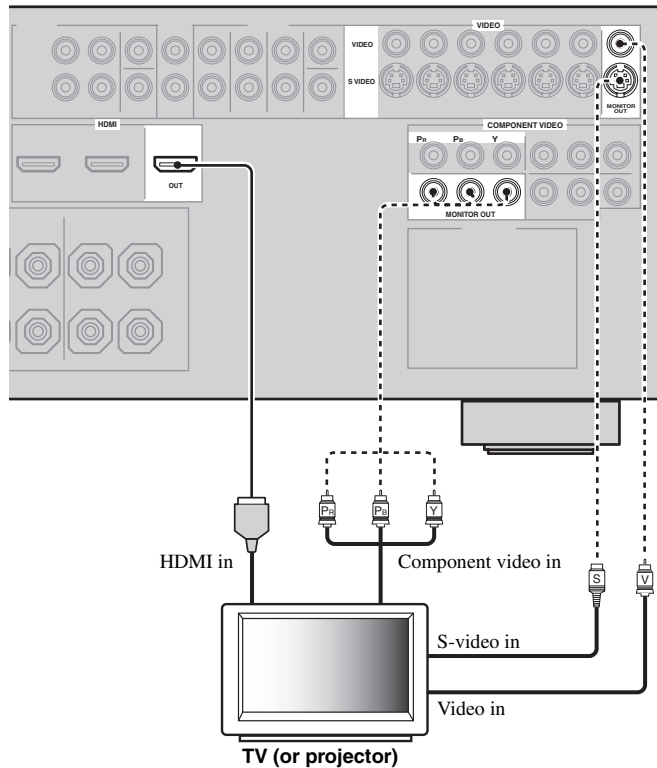

Connecting other components



Make sure that this unit and other components are unplugged from the AC wall outlets.

Notes

- When “VIDEO CONV.” is set to “OFF” (see page 79), be sure to make the same type of video connections as those made for your TV (see page 18). For example, if you connected your TV to the VIDEO MONITOR OUT jack of this unit, connect your other components to the VIDEO jacks.

■ Connecting a DVD player

- When “VIDEO CONV.” is set to “ON” (see page 79), the converted video signals are output only at the MONITOR OUT jacks. To record a source, make the same type of video connections between each component.
- To make a digital connection to a component other than the default component assigned to each DIGITAL INPUT or DIGITAL OUTPUT jack, select the corresponding setting for “OPTICAL OUT”, “OPTICAL IN”, or “COAXIAL IN” in “I/O ASSIGNMENT” (see page 76).
- If you connect your DVD player to both the DIGITAL INPUT (OPTICAL) and the DIGITAL INPUT (COAXIAL) jacks, priority is given to the signals input at the DIGITAL INPUT (COAXIAL) jack.

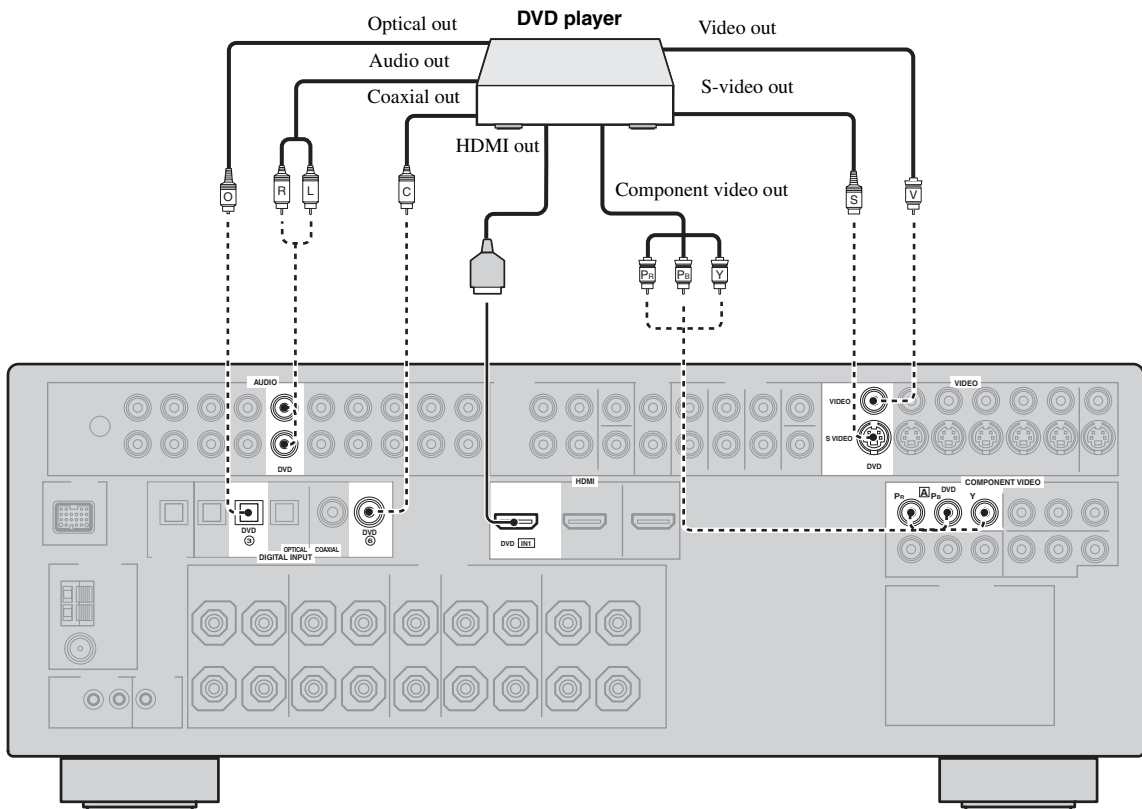

————— indicates recommended connections

- - - - - indicates alternative connections

■ Connecting a DVD recorder, PVR or VCR

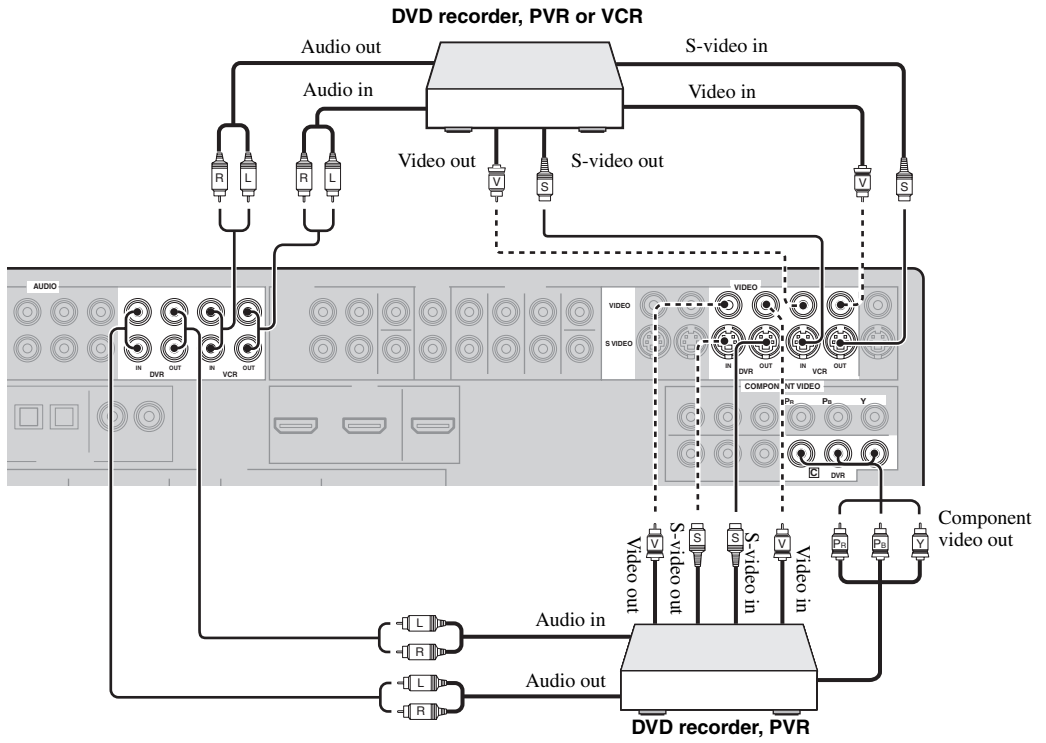

■ Connecting a set-top box

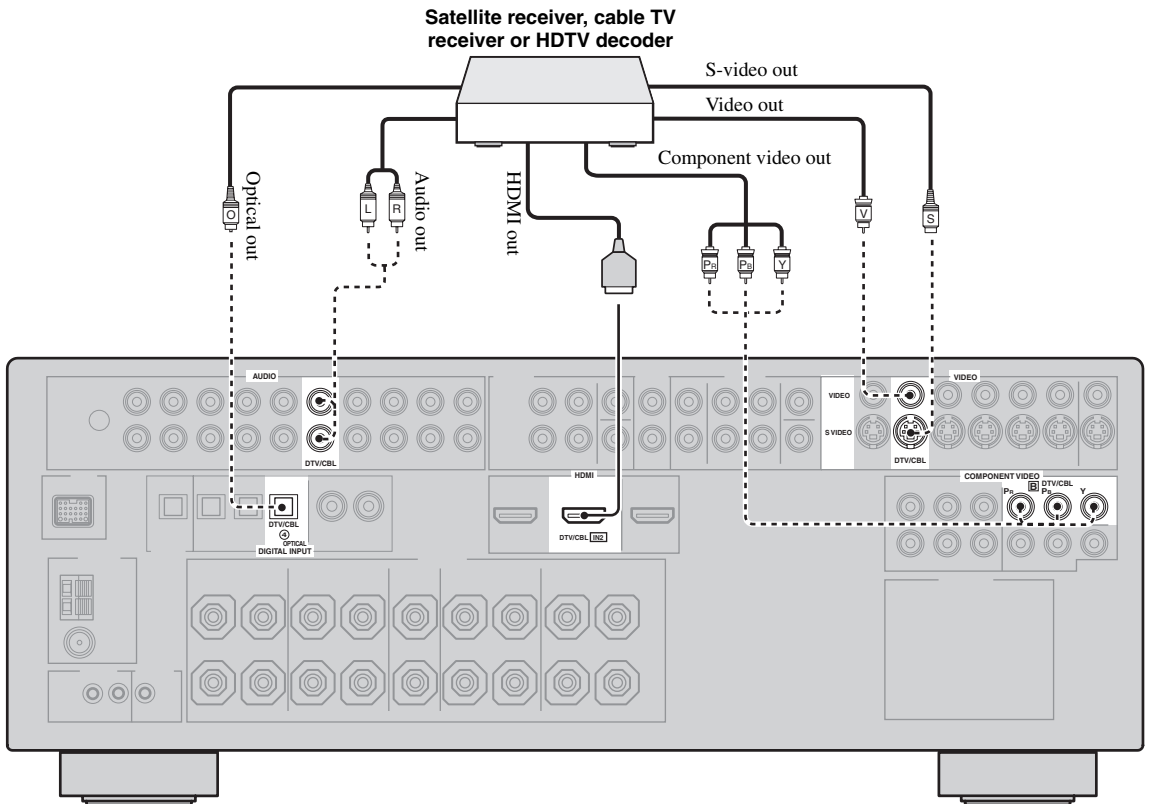

■ Connecting audio components

Notes

- To make a digital connection to a component other than the default component assigned to each the DIGITAL INPUT jack or the DIGITAL OUTPUT jack, select the corresponding setting for “OPTICAL OUT”, “OPTICAL IN”, or “COAXIAL IN” in “I/O ASSIGNMENT” (see page 76).
- Connect your turntable to the GND terminal of this unit to reduce noise in the signal. However, you may hear less noise without the connection to the GND terminal for some turntables.
- The PHONO jacks are only compatible with a turntable with an MM or a high-output MC cartridge. To connect a turntable with a low-output MC cartridge to the PHONO jacks, use an in-line boosting transformer or an MC-head amplifier.
- When you connect both the DIGITAL INPUT (OPTICAL) jack and the DIGITAL INPUT (COAXIAL) jack to an audio component, the priority is given to the DIGITAL INPUT (COAXIAL) jack.

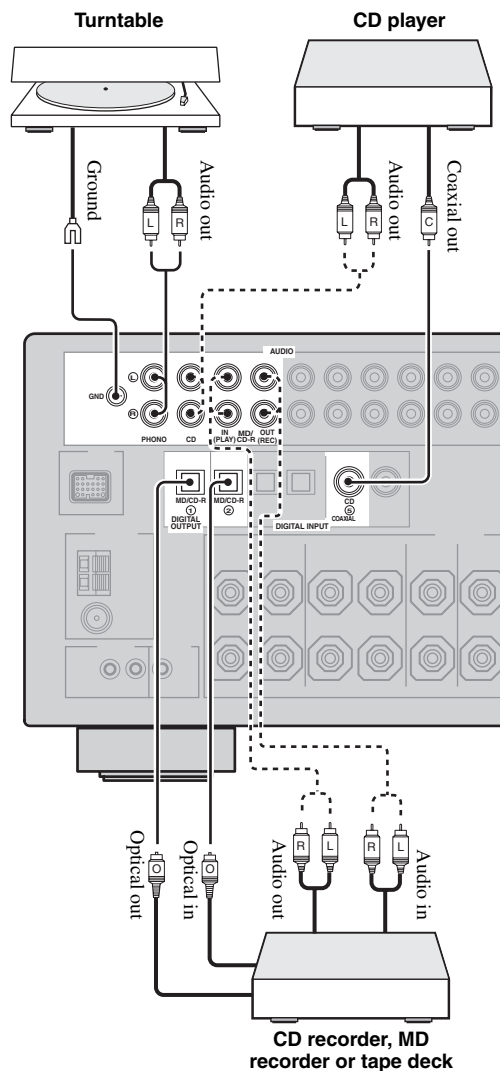

———— indicates recommended connections
 - - - - indicates alternative connections

■ Connecting an external amplifier

This unit has more than enough power for any home use. However, if you want to add more power to the speaker output or if you want to use another amplifier, connect an external amplifier to the PRE OUT jacks.

Notes

- When you make connections to the PRE OUT jacks, do not make connections to the SPEAKERS terminals.
- The signals output at the FRONT PRE OUT jacks are affected by the TONE CONTROL settings (see page 48).
- Each PRE OUT jack outputs the same channel signals as the corresponding SPEAKERS terminals.
- Adjust the volume level of the subwoofer with the control on the subwoofer (see page 48).
- Some signals may not be output at the SUBWOOFER PRE OUT jack depending on the settings for “SPEAKER SET” (see page 70) and “LFE/BASS OUT” (see page 70).

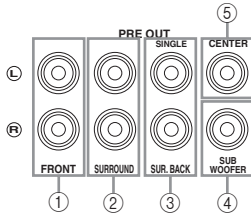

① FRONT PRE OUT jacks

Front channel output jacks.

② SURROUND PRE OUT jacks

Surround channel output jacks.

③ SUR.BACK PRE OUT jacks

Surround back channel output jacks. When you only connect one external amplifier for the surround back channel, connect it to the SINGLE jack.

Notes

- When “BI-AMP” is set to “ON”, this unit outputs the front channel audio signals at the SUR.BACK PRE OUT jacks.
- The audio signals output at the SUR.BACK PRE OUT jacks differ depending on the “EXTRA SP ASSIGN” setting (see page 70).

④ SUBWOOFER PRE OUT jack

Connect a subwoofer with a built-in amplifier.

⑤ CENTER PRE OUT jack

Center channel output jack.

■ Connecting a multi-format player or an external decoder

This unit is equipped with 6 additional input jacks (left and right FRONT, CENTER, left and right SURROUND and SUBWOOFER) for discrete multi-channel input from a multi-format player, external decoder, sound processor or pre-amplifier.

If you set “INPUT CH” to “8CH” in “MULTI CH SET” (see page 78), you can use the input jacks assigned as “FRONT” in “MULTI CH SET” (see page 78) together with the MULTI CH INPUT jacks to input 8-channel signals.

Connect the output jacks on your multi-format player or external decoder to the MULTI CH INPUT jacks. Be sure to match the left and right outputs to the left and right input jacks for the front and surround channels.

Notes

- When you select the component connected to the MULTI CH INPUT jacks as the input source (see page 38), this unit automatically turns off the digital sound field processor, and you cannot select sound field programs.
- This unit does not redirect signals input at the MULTI CH INPUT jacks to accommodate for missing speakers. We recommend that you connect at least a 5.1-channel speaker system before using this feature.

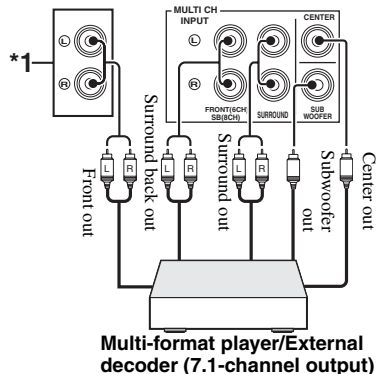
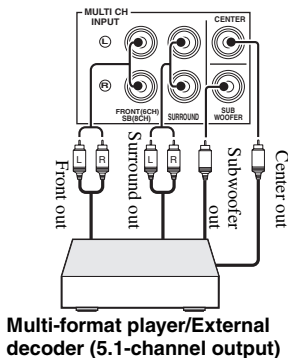

*1 The analog audio input jacks assigned as “FRONT” in “MULTI CH SET” (see page 78).

■ Connecting a Yamaha iPod universal dock

This unit is equipped with the DOCK terminal on the rear panel that allows you to connect a Yamaha iPod universal dock (such as the YDS-10, sold separately) where you can station your iPod and control playback of your iPod using the supplied remote control. Connect a Yamaha iPod universal dock to the DOCK terminal on the rear panel of this unit using its dedicated cable.

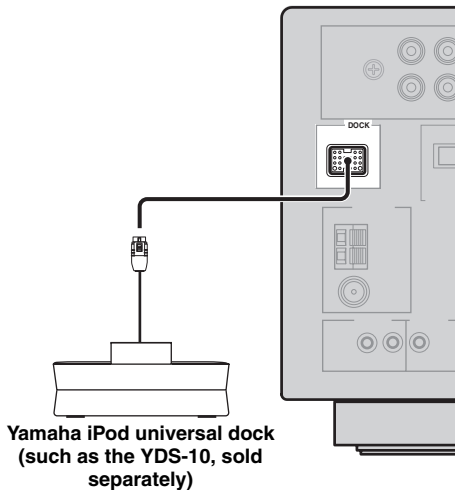

■ Using REMOTE IN/OUT jacks

When the components are the Yamaha products and have the capability of the transmission of the remote control signals, connect the REMOTE IN jack and REMOTE OUT jack to the remote control input and output jack with the monaural analog mini cable as follows.

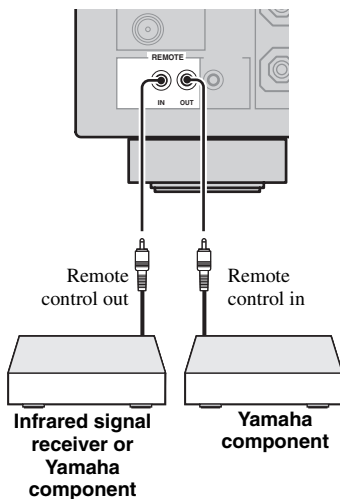

- If the components have the capability of the SCENE control signals, this unit can automatically activate the corresponding components and start the playback when you use one of the SCENE buttons. Refer to the owner's manuals for details about the capability of the SCENE control signals of the components.
- Connect the REMOTE OUT jack of this unit and the remote control input jack of the components to control the components by using the SCENE feature.
- If the component connected to the REMOTE OUT jack is not the Yamaha product, set "SCENE IR" in the advanced setup menu to "OFF" (see page 101).

Using the VIDEO AUX jacks on the front panel

Use the VIDEO AUX jacks on the front panel to connect a game console or a video camera to this unit.

Caution

Be sure to turn down the volume of this unit and other components before making connections.

Notes

- The audio signals input at the DOCK terminal on the rear panel take priority over the ones input at the VIDEO AUX jacks.
- To reproduce the source signals input at these jacks, select "V-AUX" as the input source.

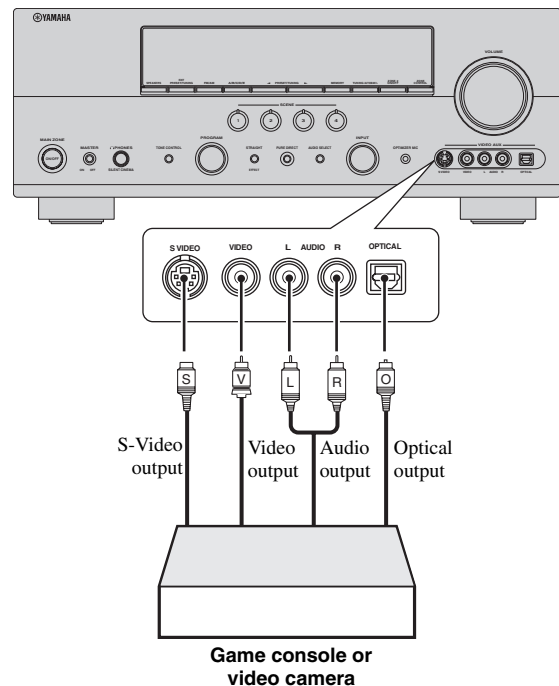

Connecting the FM and AM antennas

Both FM and AM indoor antennas are supplied with this unit. Connect each antenna correctly to the designated terminals. In general, these antennas should provide sufficient signal strength.



See page 8 for connection information of the supplied indoor FM antenna and AM loop antenna.

Notes

- The AM loop antenna should be placed away from this unit.
- The AM loop antenna should always be connected, even if an outdoor AM antenna is connected to this unit.
- A properly installed outdoor antenna provides clearer reception than an indoor one. If you experience poor reception quality, install an outdoor antenna. Consult the nearest authorized Yamaha dealer or service center about outdoor antennas.

AM loop antenna (supplied)

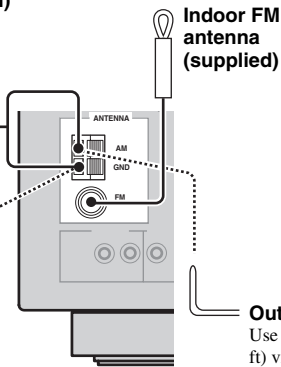

Indoor FM antenna (supplied)

Outdoor AM antenna
Use a 5 to 10 m (16 to 33 ft) vinyl-covered wire extended outdoors from a window.

Ground (GND terminal)

For maximum safety and minimum interference, connect the antenna GND terminal to a good earth ground. A good earth ground is a metal stake driven into moist earth.

Connecting the power cable

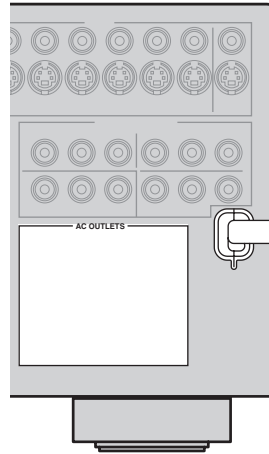

To the AC wall outlet

■ AC OUTLET(S) (SWITCHED)

U.K. and Australia models..... 1 outlet
Korea model..... None
Other models..... 2 outlets

Use these outlet(s) to supply power to any connected components. Connect the power cable of your other components to these outlet(s). Power to these outlet(s) is supplied when the main zone or Zone 2 is turned on. However, power to these outlet(s) is cut off when the main zone and Zone 2 are turned off or when **Ⓜ MASTER ON/OFF** on the front panel is pressed and released outward to the OFF position. For information on the maximum power or the total power consumption of the components that can be connected to these outlet(s), see “Specifications” on page 114.

Memory back-up

The memory back-up circuit prevents the stored data from being lost even if this unit is in the standby mode. However, the stored data will be lost in case the power cable is disconnected from the AC wall outlet or if the power supply is cut off for more than one week.

Setting the speaker impedance

Caution

If you are to use 6 ohm speakers, set “SP IMP.” to “6Ω MIN” as follows BEFORE using this unit. 4 ohm speakers can be also used as the front speakers.

1 Make sure this unit is turned off.

Refer to the right column for details.

2 Press and hold **ⓑ TONE CONTROL** on the front panel and then press **ⓓ MASTER ON/OFF** inward to the ON position to turn on this unit.

This unit turns on, and the advanced setup menu appears in the front panel display.



3 Rotate the **ⓓ PROGRAM** selector on the front panel to select “SP IMP.”.

“SP IMP.” and the current speaker impedance setting (“8Ω MIN”) appear in the front panel display.

4 Press **ⓑ TONE CONTROL** on the front panel repeatedly to select “6Ω MIN”.

5 Press **ⓓ MASTER ON/OFF** on the front panel to release it outward to the OFF position to save the new setting and turn off this unit.

Note

The setting you made is reflected next time you turn on this unit.

Turning this unit on and off

■ Turning on this unit

Press **ⓓ MASTER ON/OFF** on the front panel inward to the ON position to turn on this unit.

When you turn on this unit by pressing **ⓓ MASTER ON/OFF**, the main zone is turned on.



When you turn on this unit, there will be a 4 to 5-second delay before this unit can reproduce sound.

■ Turning off this unit

Press **ⓓ MASTER ON/OFF** on the front panel again to release it outward to the OFF position to turn off this unit.

Notes

- **ⓓ MAIN ZONE ON/OFF** on the front panel as well as **ⓓ POWER** and **ⓓ STANDBY** on the remote control are operational only when **ⓓ MASTER ON/OFF** is pressed inward to the ON position.
- As usual, we recommend using the standby mode to turn off this unit.

■ Set the main zone to the standby mode

Press **ⓓ MAIN ZONE ON/OFF** (or **ⓓ STANDBY**) to set the main zone to the standby mode.

In the standby mode, this unit consumes a small amount of power in order to receive infrared signals from the remote control.

■ Turning on the main zone from the standby mode

Press **ⓓ MAIN ZONE ON/OFF** (or **ⓓ POWER**) to turn on the main zone.



- You can also turn on the main zone by pressing **ⓓ SCENE** (or **ⓓ SCENE**) buttons.
- When you turn on this unit, there will be a 4 to 5-second delay before this unit can reproduce sound.
- These buttons are operational only when **ⓓ MASTER ON/OFF** is pressed inward to the ON position.

Front panel display

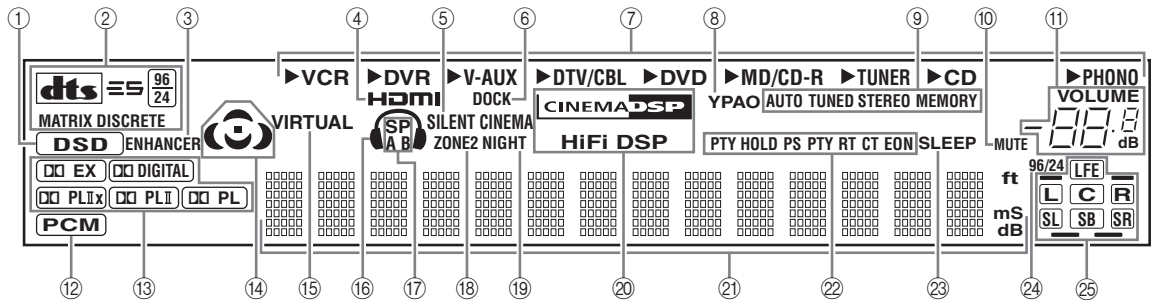

② Europe model only

①⑫ Input signal indicators

Lights up when this unit is reproducing DSD (Direct Stream Digital) or PCM (Pulse Code Modulation) digital audio signals.

②⑬ Decoder indicators

The respective indicator lights up when any of the decoders of this unit function.

③ ENHANCER indicator

Lights up when the Compressed Music Enhancer mode is selected (see page 46).

④ HDMI indicator

Lights up when the signal of the selected input source is input at HDMI IN 1 or HDMI IN 2 jacks (see page 16).

⑤ SILENT CINEMA indicator

Lights up when headphones are connected and a sound field program is selected (see page 46).

⑥ DOCK indicator

Lights up when you station your iPod in a Yamaha iPod universal dock (such as the YDS-10, sold separately) connected to the DOCK terminal of this unit (see page 23) and V-AUX is selected as the input source. The DOCK indicator also lights up when this unit is charging the battery of the stationed iPod in the standby mode.

⑦ Input source indicators

The corresponding cursor lights up to show the currently selected input source.

⑧ YPAO indicator

Lights up when you run "AUTO SETUP" and when the speaker settings set in "AUTO SETUP" are used without any modifications (see page 28).

⑨ Tuner indicators

Lights up when this unit is in the FM or AM tuning mode (see pages 50 to 52).

⑩ MUTE indicator

Flashes while the MUTE function is on (see page 40).

⑪ VOLUME level indicator

Indicates the current volume level.

⑭ Sound field indicators

Light up to indicate the active DSP sound fields.

⑮ VIRTUAL indicator

Lights up when Virtual CINEMA DSP is active (see page 46).

⑯ Headphones indicator

Lights up when headphones are connected (see page 40).

⑰ SP A B indicators

Light up according to the set of front speakers selected.

⑱ ZONE2 indicator

Lights up when Zone 2 is turned on (see page 96).

⑲ NIGHT indicator

Lights up when you select a night listening mode (see page 49).

⑳ DSP indicators

The respective indicator lights up when any of the DSP sound field programs are selected (see page 42).

㉑ Multi-information display

Shows the name of the current sound field program and other information when adjusting or changing settings.

22 Radio Data System indicators (Europe model only)

PS, PTY, RT and CT

Light up according to the selected Radio Data System display mode.

EON

Lights up when the EON data service is being received.

PTY HOLD

Lights up while searching for the Radio Data System stations in the PTY SEEK mode.

23 SLEEP indicator

Lights up while the sleep timer is on (see page 41).

24 96/24 indicator

Lights up when a DTS 96/24 signal is input to this unit.

25 Input channel and speaker indicators

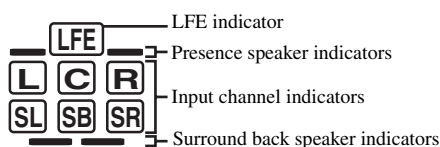

LFE indicator

Lights up when the input signal contains the LFE signal.

Input channel indicators

Indicate the channel components of the current digital input signal.

Presence and surround back speaker indicators

Light up according to the number of presence and surround back speakers set for “EXTRA SP ASSIGN” (see page 70) and “SUR. B L/R SP” (see page 71) in “SOUND MENU” when this unit is in the auto setup (see page 28) or the speaker level setting in “SOUND MENU” (see page 72) procedure.



- You can make settings for surround back speakers automatically by running “AUTO SETUP” (see page 28) or manually by adjusting settings for “SUR. B L/R SP” (see page 71) in “SOUND MENU”.
- To use the presence speakers, set “EXTRA SP ASSIGN” to “PRESENCE” (see page 29 or 70).

Using the remote control

The remote control transmits a directional infrared ray. Be sure to aim the remote control directly at the remote control sensor on this unit during operation.

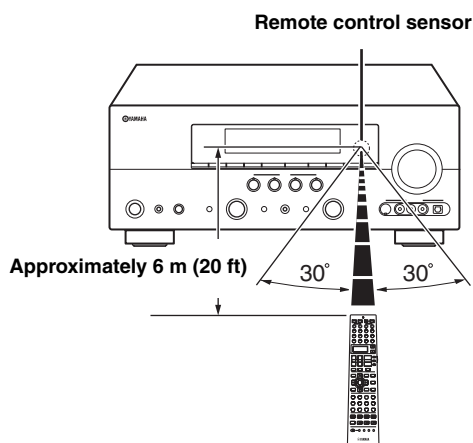

Infrared window (☺)

Outputs infrared control signals. Aim this window at the component you want to operate.

Transmit indicator (⊗)

Flashes while the remote control is sending infrared signals.

Display window (☺)

Shows the name of the selected input source that you can control.

Operation mode selector (Ⓕ)

The function of some buttons depends on the operation mode selector position.

AMP

Operates the amplifier function of this unit.

SOURCE

Operates the component selected with an input selector button (see page 84).

TV

Operates the TV assigned to either DTV/CBL or PHONO (see page 83).

Notes

- Do not spill water or other liquids on the remote control.
- Do not drop the remote control.
- Do not leave or store the remote control in the following types of conditions:
 - places of high humidity, such as near a bath
 - places of high temperatures, such as near a heater or stove
 - places of extremely low temperatures
 - dusty places
- To set the remote control codes for other components, see page 85.

Optimizing the speaker setting for your listening room

This unit employs the YPAO (Yamaha Parametric Room Acoustic Optimizer) technology which lets you avoid troublesome listening-based speaker setup and achieves highly accurate sound adjustments automatically. The supplied optimizer microphone collects and this unit analyzes the sound your speakers produce in your actual listening environment.

Using AUTO SETUP

Notes

- Be advised that it is normal for loud test tones to be output during the “AUTO SETUP” procedure.
 - To achieve the best results, make sure the room is as quiet as possible while the “AUTO SETUP” procedure is in progress. If there is too much ambient noise, the results may not be satisfactory.
- ☀
- You can run “AUTO SETUP” using the system menu that appears in the OSD or in the front panel display. This manual uses the OSD illustrations to explain the “AUTO SETUP” procedure.
 - Before performing operations, set the operation mode selector on the remote control to **AMP**.
 - This unit uses the speakers connected to the FRONT A speaker terminals as the front speakers for the adjustment.

1 Make sure of the following check points before starting the AUTO SETUP operations.

- Speakers are connected appropriately.
- Headphones are disconnected from this unit.
- This unit and the video monitor are turned on.
- The connected subwoofer is turned on and the volume level is set to about half way (or slightly less).
- The crossover frequency controls of the connected subwoofer is set to the maximum.
- The room is sufficiently quiet.

2 Connect the supplied optimizer microphone to the OPTIMIZER MIC jack on the front panel.

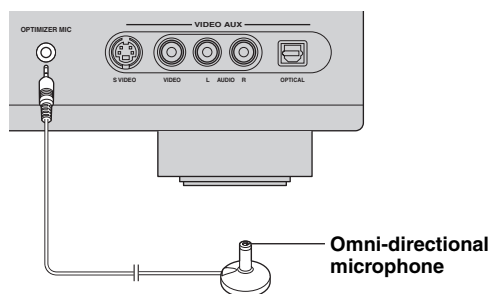

The following menu screen appears on the video monitor.

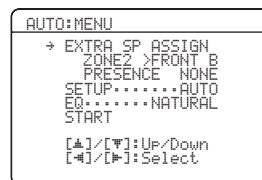

3 Place the optimizer microphone at your normal listening position on a flat level surface with the omni-directional microphone heading upward.

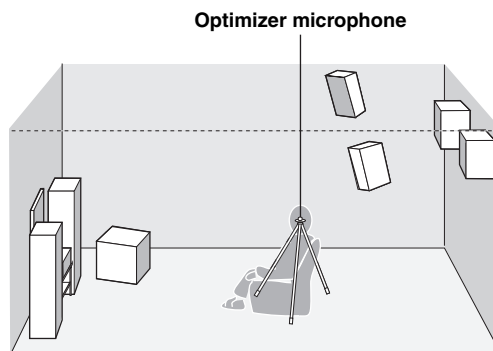

It is recommended that you use a tripod (etc.) to affix the optimizer microphone at the same height as your ears would be when you are seated in your listening position. You can use the attached screw of a tripod (etc.) to fix the optimizer microphone to the tripod (etc.).

- 4 Press **⓪** < / > to select the desired setting for “EXTRA SP ASSIGN” and then press **⓪** ▽.

Extra speaker assignment

EXTRA SP ASSIGN

Selects the function of the speakers connected to the EXTRA SP terminals.

Choices: **FRONT B**, ZONE2, PRESENCE, NONE

- **When you use the alternative front speaker system (see page 38)**
Select “FRONT B”.
- **When you use the Zone 2 speakers (see page 96)**
Select “ZONE2” to set the function of the speakers to the Zone 2 speakers. This unit drives the Zone 2 speakers by using the internal amplifier.
- **When you use the presence speakers (see page 12)**
Select “PRESENCE” to set the function of the speakers to the presence speakers.
- **When you do not use the EXTRA SP terminals**
Select “NONE” to deactivate the EXTRA SP terminals.

Note

If you select “ON” in “BI-AMP” (see page 101), you cannot select “PRESENCE” or “ZONE2” in “EXTRA SP ASSIGN”.

- 5 Press **⓪** < / > to select “SETUP”.

Choices: **AUTO**, RELOAD, UNDO, DEFAULT

- Select “AUTO” to automatically run the entire “AUTO SETUP” procedure.
- Select “RELOAD” to reload the last “AUTO SETUP” settings and override the previous settings.
- Select “UNDO” to undo the last “AUTO SETUP” settings and restore the previous settings.
- Select “DEFAULT” to reset the “AUTO SETUP” parameters to the initial factory settings.

Notes

- “RELOAD” or “UNDO” is available only when you have previously run “AUTO SETUP” and confirmed the results.
- “RELOAD” or “UNDO” is not available when you change the setting of “BI-AMP” in the advanced setup (see page 101) or “EXTRA SP ASSIGN” in “SOUND MENU” (see page 70).

- 6 Press **⓪** < / > to select the desired setting of “EQ” and then press **⓪** ▽.

Parametric equalizer type EQ

Parametric equalizer adjusts the level of the specified frequency bands. This unit automatically selects the crucial frequency bands for the listening room and adjusts the level of the selected frequency bands to create a cohesive sound field in the room. You can select the type of the parametric equalizer adjustment from the following choices.

Choices: **NATURAL**, FLAT, FRONT

- Select “NATURAL” to average out the frequency response of all speakers with higher frequencies being less emphasized. Recommended if the FLAT setting sounds a little harsh.
- Select “FLAT” to average the frequency response of all speakers. Recommended if all of your speakers are of similar quality.
- Select “FRONT” to adjust the frequency response of each speaker in accordance with the sound of your front speakers. Recommended if your front speakers are of much higher quality than your other speakers.

- 7 Press **⓪** ▽ to select “START” and then press **⓪** ENTER to start the setup procedure.

This unit starts the auto setup procedure. Loud test tones are output from each speaker during the auto setup procedure. Once all items are set, the “AUTO:RESULT” display appears in the OSD.

Notes

- During the auto setup procedure, do not perform any operation on this unit.
- We recommend getting out of the room while this unit is in the auto setup procedure. It takes approximately 3 minutes for this unit to complete the auto setup procedure.

This unit performs the following checks:

Speaker wiring WIRING

Checks which speakers are connected and the polarity of each speaker.

Speaker size SIZE

Checks the frequency response of each speaker and sets the appropriate low-frequency crossover for each channel.

Speaker distance DISTANCE

Checks the distance of each speaker from the listening position and adjusts the timing of each channel.

Equalizing EQUALIZING

Checks and adjusts the tonal characteristics of all the speakers by the setting of “EQ”.

Speaker level LEVEL

Checks and adjusts the volume level of each speaker.

The display changes as follows.

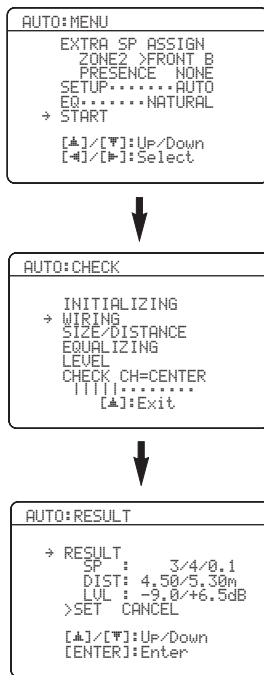

The results displayed under “RESULT” are as follows.

Number of speakers SP

Displays the number of speakers connected to this unit in the following order:
Front/Back/Subwoofer

Speaker distance DIST

Displays the speaker distance from the listening position in the following order:
Closest speaker distance/Farthest speaker distance

Speaker level LUL

Displays the speaker output level in the following order:
Lowest speaker output level/Highest speaker output level

Notes

- If “E-10:INTERNAL ERROR” appears during the testing procedure, restart from step 4.
- If you selected “RELOAD” in step 4, no test tones are output.
- If an error occurs during the “AUTO:CHECK” procedure, the setup procedure is canceled and an error screen appears. For details, see “If an error screen appears” on page 32.
- When this unit detects potential problems during the “AUTO SETUP” procedure, “WARNING” and the number of warning messages appears in the above of “RESULT” (see page 32).
- Depending on the listening environment, “SWFR PHASE:REV” appears during the “AUTO:CHECK” procedure and “SUBWOOFER PHASE” in “SOUND MENU” (see page 72) is automatically set to “REVERSE”.

8 Press ENTER to display the setup results in detail.

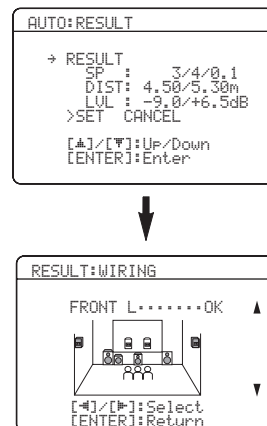

9 Press **Ⓢ**◀/▶ repeatedly to toggle between the setup result displays.

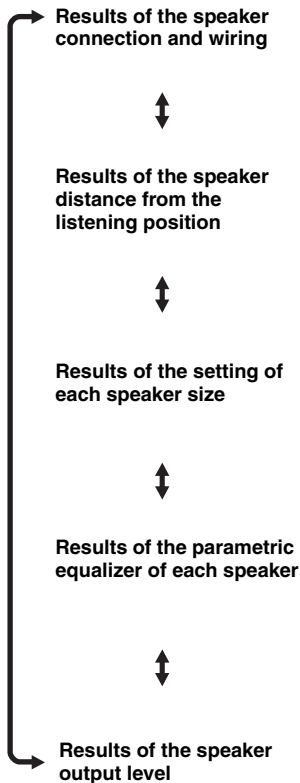

If you are not satisfied with the results or want to manually adjust each parameter, run “MANUAL SETUP” (see page 67).

Notes

- The distances displayed in the “DISTANCE” results may be longer than the actual distance depending on the characteristics of your subwoofer.
- In the “EQ” results, different values may be set for the same frequency to provide finer adjustments.

10 Press **Ⓢ****ENTER** to return to the top “AUTO:RESULT” display.

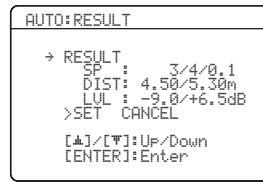

11 Make sure the pointer is pointing at “SET” and “CANCEL” and then press **Ⓢ**◀/▶ to select “SET” or “CANCEL”.

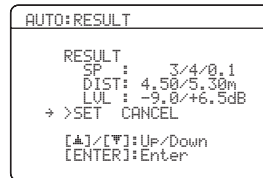

Choices: **SET**, **CANCEL**

- Select “SET” to confirm the “AUTO SETUP” results.
- Select “CANCEL” to cancel the “AUTO SETUP” results.

12 Press **Ⓢ****ENTER** to confirm your selection. The top “SET MENU” display appears in the OSD.

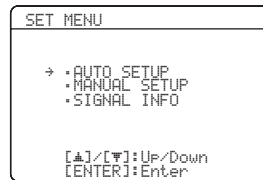

13 Press **Ⓢ****SET MENU** to exit from “SET MENU”.

14 Disconnect the optimizer microphone from this unit.

The optimizer microphone is sensitive to heat. Keep it away from direct sunlight and do not place it on top of this unit.



If you change speakers, speaker positions, or the layout of your listening environment, run “AUTO SETUP” again to recalibrate your system.

■ If an error screen appears

Press **⏪** / **⏩** / **⏴** / **⏵** to select “RETRY” or “EXIT” and then press **⏴ENTER**.

The following display is an example where “E-9:USER CANCEL” appears in the OSD.

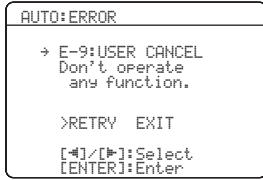

Choices: **RETRY**, **EXIT**

- Select “RETRY” to retry the “AUTO SETUP” procedure.
- Select “EXIT” to exit from the “AUTO SETUP” procedure.

■ If “WARNING” appears

When this unit detects potential problems during the “AUTO SETUP” procedure, “WARNING” appears in the “AUTO:RESULT” display. Check the warning messages to correct your speaker settings.

Note

Warnings differ from errors in that warnings do not cancel the “AUTO SETUP” procedure.

1 Make sure the pointer is pointing at “WARNING” and then press **⏴ENTER** to display the detailed information about the warning.

The number on the right of “WARNING” indicates the number of warning messages.

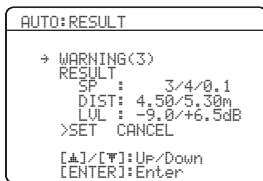

2 Press **⏴** / **⏵** repeatedly to toggle between the warning displays.

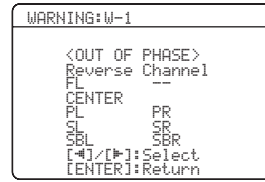

- For details about each warning message, see the “AUTO SETUP” section in “Troubleshooting” on page 107.
- When the corresponding warning message is not applicable to a speaker, “--” is displayed instead.

3 Press **⏴ENTER** to return to the top “AUTO:RESULT” display.

Selecting the SCENE templates

This unit is equipped with 17 preset SCENE templates for various situations of using this unit. As the initial factory setting, the following SCENE templates are assigned to each SCENE button:

SCENE 1: DVD Movie Viewing

SCENE 2: Music Disc Listening

SCENE 3: TV Viewing

SCENE 4: Radio Listening

If you want to use other SCENE templates, you can select the desired SCENE templates from the SCENE template library and assign the templates to the selected SCENE buttons on the front panel and the remote control.

Select the desired SCENE template

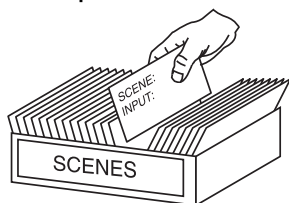

SCENE template library (Image)



Assign the SCENE template to the SCENE button

Selecting the desired SCENE template

1 Press and hold the **SCENE** (or **SCENE**) button for 3 seconds.

The indicator on the selected SCENE button on the front panel starts to flash, and the name of the currently assigned SCENE template appears in the front panel display.

3 seconds



Front panel

or

3 seconds



Remote control



Flashes

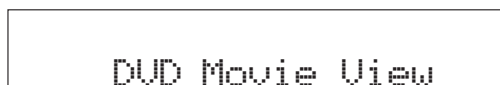

2 Rotate the **INPUT** selector (or set the operation mode selector to **AMP** and then press **</>**) to select the desired template.



3 Press the **SCENE** (or **SCENE**) button again to confirm the selection.

The selected SCENE template is assigned to the SCENE button.



Front panel

or



Remote control

Notes

- If you do not carry out any operation within 30 seconds from the last operation in these steps, this procedure is automatically canceled.
- Once the desired SCENE templates are assigned to the corresponding SCENE buttons, you need to set the input source of the SCENE template on the remote control. See page 82 for details.



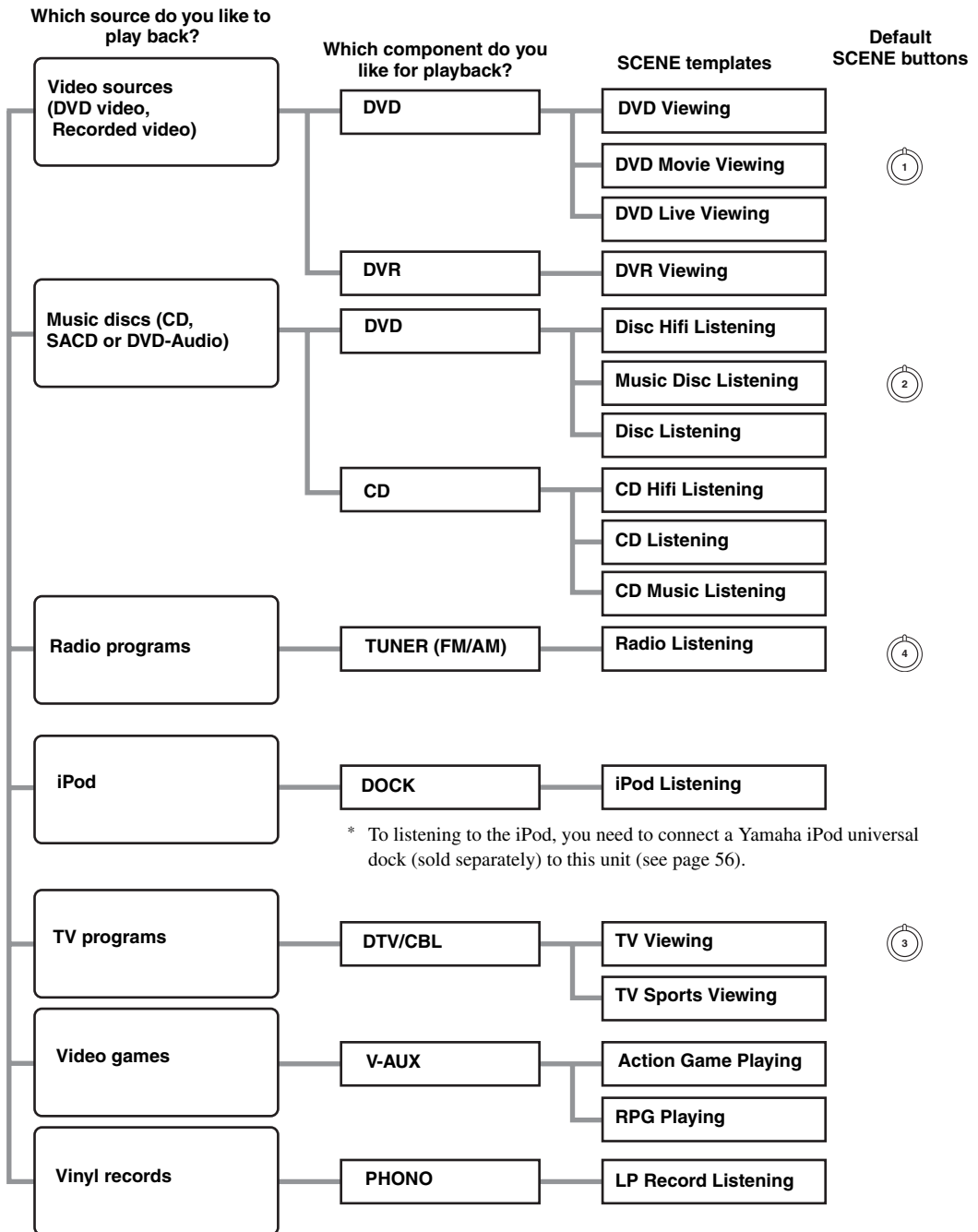

■ Which SCENE template would you like to select?



You can create your original SCENE templates by editing the preset SCENE templates. See page 36 for details.

■ Preset SCENE templates descriptions

The illustrations of the SCENE button in the following table indicate the assigned SCENE buttons as the default setting.

SCENE template	Input source	Playback mode	Features
DVD Viewing	DVD*1	STRAIGHT	Select this SCENE template when you play back general contents on the DVD player.
DVD Movie Viewing 	DVD*1	MOVIE Sci-Fi	Select this SCENE template when you play back movies on your DVD player.
DVD Live Viewing	DVD*1	ENTERTAINMENT Music Video	Select this SCENE template when you enjoy the music live video on your DVD player.
DVR Viewing	DVR	MOVIE Drama	Select this SCENE template when you play back movies on your digital video recorder.
Disc Hifi Listening	DVD*1	PURE DIRECT	Select this SCENE template when you enjoy the high fidelity sound of the music discs on your DVD player.
Music Disc Listening 	DVD*1	STEREO 2ch STEREO	Select this SCENE template when you play back music discs on your DVD player.
Disc Listening	DVD*1	STEREO 7ch STEREO	Select this SCENE template when you play back music sources on your DVD player as the background music.
CD Hifi Listening	CD*1	PURE DIRECT	Select this SCENE template when you enjoy the high fidelity sound of the music discs on your CD player.
CD Listening	CD*1	STEREO 2ch STEREO	Select this SCENE template when you play back music discs on your CD player.
CD Music Listening	CD*1	STEREO 7ch STEREO	Select this SCENE template when you play back music source on your CD player as the background music.
Radio Listening 	TUNER	MUSIC ENHANCER 7ch Enhancer	Select this SCENE template when you enjoy FM or AM radio programs.
iPod Listening	DOCK (V-AUX)	MUSIC ENHANCER 7ch Enhancer	Select this SCENE template when you play back music on your iPod stationed in a Yamaha iPod universal dock.
TV Viewing 	DTV/CBL	STRAIGHT	Select this SCENE template when you enjoy general programs on your TV.
TV Sports Viewing	DTV/CBL	ENTERTAINMENT Sports	Select this SCENE template when you enjoy sports programs on your TV.
Action Game Playing	V-AUX*2	ENTERTAINMENT Action Game	Select this SCENE template when you play action games such as car racing and FPS games.
RPG Playing	V-AUX*2	ENTERTAINMENT Roleplaying Game	Select this SCENE template when you play role-playing games.
LP Record Listening	PHONO	PURE DIRECT	Select this SCENE template when you play back vinyl records on your turntable.

*1 When the connected DVD player or CD player has the capability of the SCENE control signals and is connected to the REMOTE OUT jack of this unit, this unit operates the DVD player or CD player worked with the SCENE features.

*2 You can select "V-AUX" as the input source even if your iPod is stationed in the Yamaha Universal Dock connected to this unit.

Creating your original SCENE templates

You can create your original SCENE templates for each SCENE button. You can refer to the preset 17 SCENE templates to create the original SCENE templates.

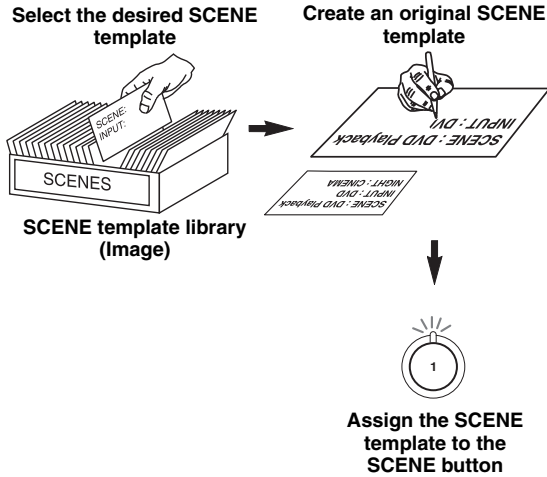

1 Turn on the video monitor connected to this unit.

2 Set the operation mode selector to **LAMP and then press and hold the desired **AScene** button for 3 seconds.**

The SCENE template customizing screen appears on the video monitor.

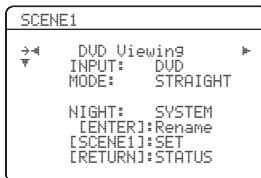

Note

When the SCENE template you want to customize is not assigned to any of the **AScene** buttons, press **◁/▷** repeatedly to recall the desired SCENE template on the menu screen.

3 Press **◁/▷ to select the desired parameter of the SCENE template and then **◁/▷** to select the desired value of the selected parameter.**

You can adjust the following parameters for a SCENE template:

- **INPUT:** The input source component.
- **MODE:** The active sound field programs, STRAIGHT or Pure Direct mode.
- **NIGHT:** The night listening mode (see page 49).
 - **SYSTEM:** Keeps the current night listening mode.
 - **CINEMA:** Sets the night listening mode to the CINEMA mode.
 - **MUSIC:** Sets the night listening mode to the MUSIC mode.

4 Press the **AScene button again to confirm the edit.**



An asterisk mark (*) appears by the name of the original SCENE template.

Notes

- Once the desired SCENE templates are assigned to the corresponding **AScene** buttons, you need to set the input source of the SCENE template on the remote control. See page 82 for details.
- You can create a customized SCENE template for each SCENE button, and if you create another customized SCENE template, this unit overwrites the old customized SCENE template with the new one.
- The newly created template is only available for the assigned SCENE button.

■ Rename the SCENE templates

Select the name of the SCENE template at step 3 of “Creating your original SCENE templates” and then press **◁ENTER.**

- Press **◁/▷** to select the desired character.
- Press **◁/▷** to place an “_” (underscore) under the space or the desired character.
- Press **RETURN** to cancel the new name.
- Press **◁ENTER** to confirm the new name.

Playback

Caution

Extreme caution should be exercised when you play back CDs encoded in DTS. If you play back a CD encoded in DTS on a DTS-incompatible CD player, you will only hear some unwanted noise that may damage your speakers. Check whether your CD player supports CDs encoded in DTS. Also, check the sound output level of your CD player before you play back a CD encoded in DTS.



To play DTS-encoded CDs when using a digital audio connection, set "DECODER MODE" in "INPUT MENU" to "DTS" before the playback (see page 78).



Before performing operations, set the operation mode selector on the remote control to **AMP**.

Basic procedure

1 Turn on the video monitor connected to this unit.



See page 40 to display the input source information.

2 Rotate the **INPUT** selector (or press one of the input selector buttons (Ⓢ)) to select the desired input source.

The name of the currently selected input source appears in the front panel display for a few seconds.

Available input sources



Currently selected input source



The corresponding input selector button on the remote control for the currently selected input source lights up for approximately 5 seconds after you press any buttons on the remote control, showing which source component is currently being operated.

3 Start playback on the selected source component or select a broadcast station.

- Refer to the operating instructions for the source component.
- See page 50 for details about tuning instructions.

4 Rotate **VOLUME** (or press **VOLUME +/-**) to adjust the volume to the desired output level.



- See page 48 to adjust the level of each speaker.
- This does not affect the AUDIO OUT (REC) level.
- You can set the initial volume level and maximum volume level (see page 75).

5 Rotate the **PROGRAM** selector (or press one of the sound field program selector buttons (Ⓢ)) repeatedly) to select the desired sound field program.

The name of the selected sound field program appears in the front panel display. See page 42 for details about sound field programs.

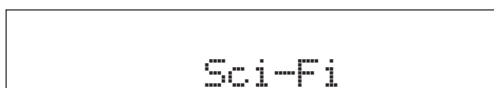

Currently selected sound field program

Note

Sound field programs cannot be selected when the component connected to the MULTI CH INPUT jacks is selected as the input source (see page 38).



- Choose a sound field program based on your listening preference, not merely on the name of the program.
- When you select an input source, this unit automatically selects the last sound field program used with the corresponding input source.
- To display information about the currently selected sound field program in the OSD, see page 59 for details.

■ A quick guide to contents

When you want to...	See page
Enjoy pure hi-fi stereo sound	48
Adjust the tonal quality of the front speakers	48
Adjust the parameters of sound field programs	59
Enjoy sources with a wide dynamic range at night	49
Use headphones	40
Enjoy multi-channel sources in 2-channel stereo	49
Select a decoder to play back sources with	64
Automatically set this unit to the standby mode	41

Selecting the MULTI CH INPUT component

Use this feature to select the component connected to the MULTI CH INPUT jacks (see page 22) as the input source.

Rotate the **Ⓘ** INPUT selector to select MULTI CH (or **ⓑ** MULTI CH IN).

“MULTI CH” appears in the front panel display.



Use “MULTI CH SET” menu in “INPUT MENU” to set the parameters for MULTI CH INPUT (see page 78).

Note

Sound field programs and the night listening mode cannot be selected when the component connected to the MULTI CH INPUT jacks is selected as the input source.

Selecting the front speaker set

Use this feature to turn the front speaker system (FRONT A and/or FRONT B) on or off.

Press **①** **SPEAKERS** on the front panel repeatedly to turn on or off the set of front speakers connected to the FRONT A and/or EXTRA SP speaker terminals.

The active front speaker set changes as follows:

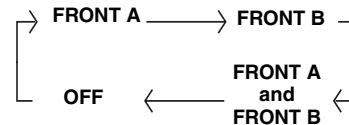

Notes

- FRONT A and B or FRONT B setting is not available when “EXTRA SP ASSIGN” is set to “PRESENCE”, “ZONE 2” or “NONE” (see page 70).
- Turn off the volume level of this unit when you switch the front speaker setting.

■ Using the Zone B feature

When you set “FRONT B” to “ZONE B” (see page 70), you can use the speakers connected to the EXTRA SP speaker terminals in another room (Zone B).

Press **①** **SPEAKERS** on the front panel repeatedly to turn on or off the Zone B speakers.

When you activate the Zone B speakers, all the speakers in the main room are muted.

Notes

- You cannot activate both the main room and Zone B speakers simultaneously.
- If you select CINEMA DSP sound field program and activate the Zone B speakers, Virtual CINEMA DSP activates automatically (see page 46).

Selecting audio input jacks (AUDIO SELECT)

This unit comes with a variety of input jacks. Use this feature (audio input jack select) to switch between input jacks when more than one input jack is assigned to as the same input source.



- We recommend setting the audio input jack select to "AUTO" in most cases.
- You can adjust the default audio input jack select of this unit by using "AUDIO SELECT" in "OPTION MENU" (see page 80).

Press **Ⓜ** **AUDIO SELECT** (or **Ⓜ** **AUDIO**) repeatedly to select the desired audio input jack select setting.

Available input sources



Currently selected audio input jack select setting

AUTO	Automatically selects input signals in the following order: (1) HDMI (2) Digital signals (3) Analog signals
HDMI	Selects only HDMI signals. When HDMI signals are not input, no sound is output.
COAX/OPT	Automatically selects input signals in the following order: (1) Digital signals input at the COAXIAL jack. (2) Digital signals input at the OPTICAL jack. When no signals are input, no sound is output.
ANALOG	Selects only analog signals. If no analog signals are input, no sound is output.

Note

This feature is not available when no digital input jacks (OPTICAL, COAXIAL and HDMI) are assigned. Use "I/O ASSIGNMENT" in "INPUT MENU" to reassign the respective input jack (see page 76).

Displaying the current status of this unit on a video monitor

You can display the operating information of this unit on a video monitor.

- 1 Turn on the video monitor connected to this unit.
- 2 Set the operation mode selector to **Ⓜ** **AMP** and then press **Ⓜ** **DISPLAY** on the remote control.

The current status screen appears in the OSD.

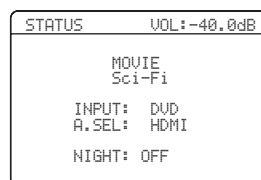

You can select the amount of time that the current status is displayed in the OSD by using the "OSD-AMP" parameter in "OPTION MENU" (see page 79).

Note

The OSD signal is not output at the VIDEO output jacks and will not be recorded.

Using your headphones

Connect a pair of headphones with a stereo analog audio cable plug to the PHONES jack on the front panel.

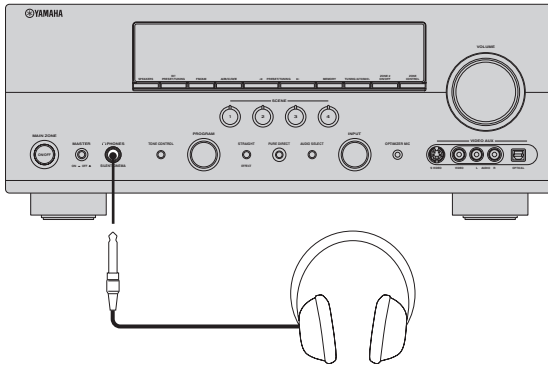

When you select a sound field program, SILENT CINEMA mode activates automatically (see page 46).

Notes

- When you connect headphones, no signals are output at the speaker terminals.
- All Dolby Digital and DTS audio signals are mixed down to the left and right headphone channels.

Muting the audio output

Press **M MUTE** on the remote control to mute the audio output. Press **M MUTE** again to resume the audio output.



- You can also rotate **VOLUME** on the front panel or press **VOLUME +/-** to resume the audio output.
- You can adjust the muting level by using the "MUTE TYPE" parameter in "SOUND MENU" (see page 74).
- The MUTE indicator flashes in the front panel display when the audio output is muted and disappears from the front panel display when the audio output is resumed.

Playing video sources in the background of an audio source

You can combine a video image from a video source with sound from an audio source. For example, you can enjoy listening to classical music while viewing beautiful scenery from the video source on the video monitor.

Press the input selector buttons (ⓑ) on the remote control to select a video source and then an audio source.

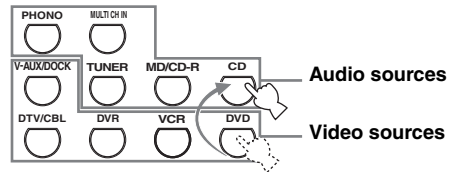

Set the "BGV" parameter in the "MULTI CH SET" menu to the desired setting to select the default background video input source of the MULTI CH INPUT sources (see page 78).

Displaying the input source information

You can display the format, sampling frequency, channel, bit rate and flag data of the current input signal.

- 1 Set the operation mode selector to **AMP** and then press **SET MENU** on the remote control.

The top "SET MENU" display appears in the OSD.

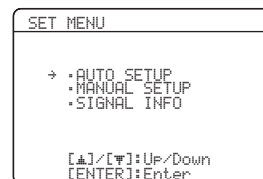

- 2 Press **▽** repeatedly to select "SIGNAL INFO" and then press **ENTER**.

The audio information about the input source appears in the OSD.

- 3 Press **◀/▶** to toggle between the audio and video information displays.

- 4 Press **Ⓜ** **SET MENU** on the remote control again to exit from “SET MENU”.

■ Audio information

FORMAT	Signal format. When this unit cannot detect a digital signal, it automatically switches to analog input.
SAMPLING	The number of samples per second taken from a continuous signal to make a discrete signal.
CHANNEL	The number of source channels in the input signal (front/surround/LFE). For example, a multi-channel soundtrack with 3 front channels, 2 surround channels and LFE, is displayed as “3/2/0.1”.
BITRATE	The number of bits passing a given point per second.
FLAG	Flag data encoded in DTS, Dolby Digital, or PCM signals that cue this unit to automatically switch decoders.

Note

“---” appears when this unit cannot display the corresponding information.

■ Video information

HDMI RES.	Resolution of the HDMI signals input or output at the HDMI IN/OUT jacks of this unit.
HDMI ERROR	Error message for HDMI sources or connected HDMI devices. See page 107 for details.

Using the sleep timer

Use this feature to automatically set the main zone to the standby mode after a certain amount of time. The sleep timer is useful when you are going to sleep while this unit is playing or recording a source. The sleep timer also automatically turns off any external components connected to the AC OUTLET(S) (see page 24).

Set the operator mode to **Ⓛ** **AMP** and then press **Ⓢ** **SLEEP** repeatedly to set the amount of time.

Each time you press **Ⓢ** **SLEEP**, the front panel display changes as shown below.

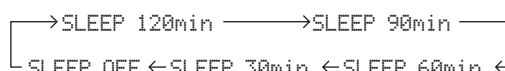

The SLEEP indicator flashes while you are switching the amount of time for the sleep timer. Once the sleep timer is set, the SLEEP indicator lights up in the front panel display, and the display returns to the selected sound field program.

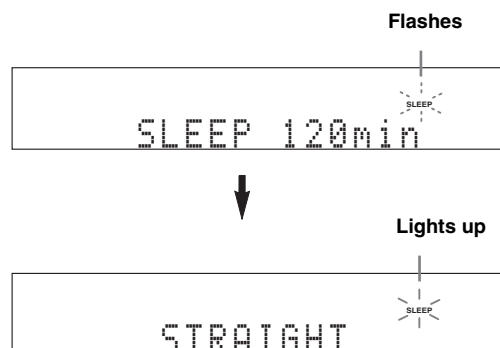

■ Canceling the sleep timer

Press **Ⓢ** **SLEEP** on the remote control repeatedly until “SLEEP OFF” appears in the front panel display.



The SLEEP indicator turns off, and “SLEEP OFF” disappears from the front panel display after a few seconds.



The sleep timer setting can also be canceled by pressing **Ⓜ** **STANDBY** (or **Ⓜ** **MAIN ZONE ON/OFF**) to set the main zone to the standby mode.

Sound field programs

This unit is equipped with a variety of precise digital decoders that allow you to enjoy multi-channel playback from almost any stereo or multi-channel sound source. This unit is also equipped with a Yamaha digital sound field processing (DSP) chip containing several sound field programs which you can use to enhance your playback experience.



- The Yamaha HiFi DSP sound field programs recreate real-world acoustic environments made from precise measurements taken in actual concert halls, music venues, movie theaters, etc. Thus, you may notice variations in the strength of the reflections coming from the front, back, left and right.
- You can change sound field parameters. See page 59 for details.

Selecting sound field programs

Rotate the **⑭ PROGRAM** selector (or set the operation mode selector to **Ⓐ AMP** and then press one of the sound field selector buttons (**Ⓢ**) repeatedly).

The name of the selected sound field program appears in the front panel display and in the OSD.

Notes

- When you select an input source, this unit automatically selects the last sound field program used with the corresponding input source.

- Sound field programs cannot be selected when the component connected to the MULTI CH INPUT jacks is selected as the input source (see page 38).
- When you play back DTS 96/24 sources with any sound field program, this unit applies the selected program without activating the DTS 96/24 decoder.
- Sampling frequencies higher than 48 kHz are sampled down to 48 kHz or lower and then sound field programs are applied.
- When the sampling frequency of the input sources are higher than 96 kHz, this unit does not apply any sound field programs.

Sound field program descriptions



Select a sound field program based on your listening preference, not merely on the name of the program, etc.

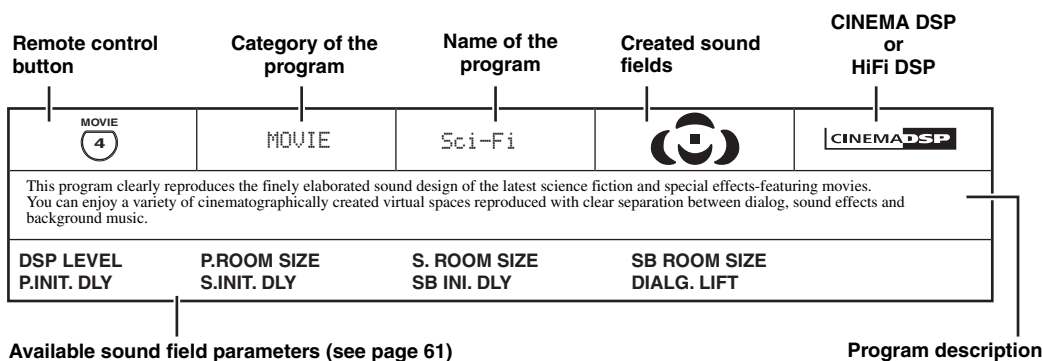

Sound field indicators

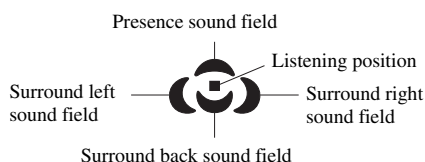

■ For audio music sources



For audio music sources, we also recommend using the Pure Direct mode (see page 48).

Notes

- The available sound field parameters differ depending on the settings of the speakers.
- “DIALG.LIFT” is available only when “EXTRA SP ASSIGN” in “SPEAKER SET” is set to “PRESENCE” (see page 70).

CLASSICAL ①	CLASSICAL	Hall in Munich		HiFi DSP
This sound field simulates a concert hall with approximately 2500 seats in Munich, using stylish wood for the interior finishing as normal standards for European concert halls. Fine, beautiful reverberations spread richly, creating a calming atmosphere. The listener's virtual seat is at the center left of the arena.				
DSP LEVEL INIT. DLY	ROOM SIZE LIVENESS	DIALG.LIFT		
CLASSICAL ①	CLASSICAL	Hall in Vienna		HiFi DSP
This is an approximately 1700-seated, middle-sized concert hall with a shoebox shape that is traditional in Vienna. Pillars and ornate carvings create extremely complex reflections from all around the audience, producing a very full, rich sound.				
DSP LEVEL INIT. DLY	ROOM SIZE LIVENESS	DIALG.LIFT		
CLASSICAL ①	CLASSICAL	Chamber		HiFi DSP
This program creates a relatively wide space with a high ceiling like an audience hall in a palace. It offers pleasant reverberations that are suitable for courtly music and chamber music.				
DSP LEVEL INIT. DLY	LIVENESS REV.TIME	REV.DELAY REV. LEVEL	DIALG.LIFT	
LIVE/CLUB ②	LIVE/CLUB	Cellar Club		HiFi DSP
This program simulates a live house with a low ceiling and homey atmosphere. A realistic, live sound field features powerful sound as if the listener is in a row in front of a small stage.				
DSP LEVEL INIT. DLY	ROOM SIZE LIVENESS	DIALG.LIFT		
LIVE/CLUB ②	LIVE/CLUB	The Roxy Theatre		HiFi DSP
This is the sound field of a rock music live house in Los Angeles, with approximately 460 seats. The listener's virtual seat is at the center left of the hall.				
DSP LEVEL INIT. DLY	ROOM SIZE LIVENESS	REV.TIME REV.DELAY	REV. LEVEL DIALG.LIFT	
LIVE/CLUB ②	LIVE/CLUB	The Bottom Line		HiFi DSP
This is the sound field at stage front in The Bottom Line, a famous New York jazz club. The floor can seat 300 people to the left and right in a sound field offering real and vibrant sound.				
DSP LEVEL INIT. DLY	ROOM SIZE LIVENESS	DIALG.LIFT		

■ For various sources

Notes

- The available sound field parameters and the created sound fields differ depending on the input sources and the settings of this unit.
- “DIALG.LIFT” is available only when “EXTRA SP ASSIGN” in “SPEAKER SET” is set to “PRESENCE” (see page 70).

ENTERTAIN 3	ENTERTAINMENT	Sports		CINEMA DSP
This program allows the listeners to enjoy stereo sport broadcasts and studio variety programs with enriched live feeling. In sports broadcasts, the voices of the commentator and sportscaster are positioned clearly at the center while the atmosphere of the stadium expands in an optimum space to offer the listeners with a feeling of presence in the stadium.				
DSP LEVEL P. INIT. DLY	P. ROOM SIZE S. INIT. DLY	S. ROOM SIZE SB INI. DLY	SB ROOM SIZE DIALG.LIFT	

ENTERTAIN 3	ENTERTAINMENT	Action Game		CINEMA DSP
This sound field has been suitable for action games such as car racing and FPS games. It uses the reflection data that limits the effects range per channel in order to offer a powerful playing environment with a being-there feeling by enhancing various effects tones while maintaining a clear sense of directions.				
DSP LEVEL P. INIT. DLY	P. ROOM SIZE S. INIT. DLY	S. ROOM SIZE SB INI. DLY	SB ROOM SIZE DIALG.LIFT	

ENTERTAIN 3	ENTERTAINMENT	Roleplaying Game		CINEMA DSP
This sound field has been suitable for role-playing and adventure games. It combines the sound field effects for movies and the sound field designs for “Action Game” to represent the depth and 3D feeling of the field during play, while offering movie-like surround effects in the movie scenes in the game.				
DSP LEVEL P. INIT. DLY	P. ROOM SIZE S. INIT. DLY	S. ROOM SIZE SB INI. DLY	SB ROOM SIZE DIALG.LIFT	

■ For visual sources of music

Notes

- The available sound field parameters and the created sound fields differ depending on the input sources and the settings of this unit.
- “DIALG.LIFT” is available only when “EXTRA SP ASSIGN” in “SPEAKER SET” is set to “PRESENCE” (see page 70).

ENTERTAIN 3	ENTERTAINMENT	Music Video		CINEMA DSP
This sound field offers an image of a concert hall for live performance of pop, rock and jazz music. The listener can indulge oneself in a hot live space thanks to the presence sound field that emphasizes the vividness of vocals and solo play and the beat of rhythm instruments, and to the surround sound field that reproduces the space of a big live hall.				
DSP LEVEL P. INIT. DLY	P. ROOM SIZE S. INIT. DLY	S. ROOM SIZE SB INI. DLY	SB ROOM SIZE DIALG.LIFT	

■ For movie sources



You can select the desired decoder used with following sound field program (except “Mono Movie”). See page 64 for details.

Notes

- The available sound field parameters and the created sound fields differ depending on the input sources and the settings of this unit.
- “DIALG.LIFT” is available only when “EXTRA SP ASSIGN” in “SPEAKER SET” is set to “PRESENCE” (see page 70).

	MOVIE	Standard		
This program creates a sound field emphasizing the surrounding feeling without disturbing the original acoustic positioning of multi-channel audio such as Dolby Digital and DTS. It has been designed with the concept of “an ideal movie theater”, in which the audience is surrounded by beautiful reverberations from the left, right and rear.				
DSP LEVEL S. INIT. DLY	S. ROOM SIZE S.LIVENESS	SB INI. DLY SB ROOM SIZE	SB LIVENESS DIALG.LIFT	

	MOVIE	Spectacle		
This program represents the spectacular feeling of large-scale movie productions. It reproduces a broad theater sound field matching the cinemascope and wider-screen movies with an excellent dynamic range from very small to extremely large sound.				
DSP LEVEL P. INIT. DLY	P. ROOM SIZE S. INIT. DLY	S. ROOM SIZE SB INI. DLY	SB ROOM SIZE DIALG.LIFT	

	MOVIE	Sci-Fi		
This program clearly reproduces the finely elaborated sound design of the latest science fiction and special effects-featuring movies. You can enjoy a variety of cinematographically created virtual spaces reproduced with clear separation between dialog, sound effects and background music.				
DSP LEVEL P. INIT. DLY	P. ROOM SIZE S. INIT. DLY	S. ROOM SIZE SB INI. DLY	SB ROOM SIZE DIALG.LIFT	

	MOVIE	Adventure		
This program is ideal for precisely reproducing the sound design of action and adventure movies. The sound field restrains reverberations but puts emphasis on reproducing a powerful space expanded widely to the left and right. The reproduced depth is also restrained relatively to ensure the separation between audio channels and the clarity of the sound.				
DSP LEVEL P. INIT. DLY	P. ROOM SIZE S. INIT. DLY	S. ROOM SIZE SB INI. DLY	SB ROOM SIZE DIALG.LIFT	



	MOVIE	Drama		
This sound field features stable reverberations that match a wide range of movie genres from serious dramas to musicals and comedies. The reverberations are modest but offer an optimum 3D feeling, reproducing effects tones and background music softly but cubically around clear words and center positioning in a way that does not fatigue the listener even after long hours of viewing.				
DSP LEVEL P. INIT. DLY	P. ROOM SIZE S. INIT. DLY	S. ROOM SIZE SB INI. DLY	SB ROOM SIZE DIALG.LIFT	

	MOVIE	Mono Movie		
This program is provided for reproducing monaural video sources such as a classic movie in an atmosphere of a good old movie theater. The program produces the optimum expansion and reverberation to the original audio to create a comfortable space with a certain sound depth.				
DSP LEVEL INIT. DLY	ROOM SIZE LIVENESS	REV.TIME REV.DELAY	REV. LEVEL DIALG.LIFT	



■ Stereo playback

Note

The available parameters differ depending on the input sources and the settings of this unit.

	STEREO	2ch STEREO		
Use this program to mix down multi-channel sources to 2 channels. See page 49 for details.				
DIRECT				
	STEREO	7ch STEREO		HiFi DSP
Use this program to output sound from all speakers. When you play back multi-channel sources, this unit downmixes the source to 2 channels, and then outputs the sound from all speakers. This program creates a larger sound field and is ideal for background music at parties, etc.				
CT LEVEL SL LEVEL	SR LEVEL SB LEVEL	PL LEVEL PR LEVEL		

■ The Compressed Music Enhancer

	MUSIC ENHANCER	2ch Enhancer		
The Compressed Music Enhancer feature of this unit enhances your listening experience by regenerating the missing harmonics in a compression artifact. As a result, flattened complexity due to the loss of high-frequency fidelity as well as lack of bass due to the loss of low-frequency bass is compensated, providing improved performance of the overall sound system. Use this program to play back compression artifacts in 2-channel stereo.				
Effect level				
	MUSIC ENHANCER	7ch Enhancer		
Use this program to play back compression artifacts in 7-channel stereo.				
Effect level				

■ Using sound field programs without surround speakers (Virtual CINEMA DSP)

Virtual CINEMA DSP allows you to enjoy the CINEMA DSP programs without surround speakers. It creates virtual speakers to reproduce the natural sound field. When you set “SUR. L/R SP” to “NONE” (see page 71), Virtual CINEMA DSP activates automatically whenever you select a CINEMA DSP or HiFi DSP sound field program (see page 42).

Note

Virtual CINEMA DSP will not activate even when “SUR. L/R SP” is set to “NONE” (see page 71) in the following cases:

- when the component connected to the MULTI CH INPUT jacks is selected as the input source (see page 38).
- when headphones are connected to the PHONES jack.
- when this unit is in the “7ch Stereo” mode.

■ Enjoying multi-channel sources and sound field programs with headphones (SILENT CINEMA)

SILENT CINEMA allows you to enjoy multi-channel music or movie sound, including Dolby Digital and DTS sources, through ordinary headphones. SILENT CINEMA activates automatically whenever you connect headphones to the PHONES jack while listening to CINEMA DSP or HiFi DSP sound field programs (see page 42). When activated, the SILENT CINEMA indicator lights up in the front panel display.

Notes

- SILENT CINEMA does not activate when the component connected to the MULTI CH INPUT jacks is selected as the input source (see page 38).
- SILENT CINEMA is not effective when the Pure Direct (see page 48) or “2ch Stereo” mode (see page 49) is selected, or when this unit is in the “STRAIGHT” mode (see page 47).

Enjoying unprocessed input sources (Straight decoding mode)

When this unit is in the “STRAIGHT” mode, 2-channel stereo sources are output from only the front left and right speakers. Multi-channel sources are decoded straight into the appropriate channels without any additional effect processing.

Press **Ⓜ** **STRAIGHT** (or **Ⓢ** **STRAIGHT**) to select “STRAIGHT”.

STRAIGHT

■ Deactivating the “STRAIGHT” mode

Press **Ⓜ** **STRAIGHT** (or **Ⓢ** **STRAIGHT**) so that “STRAIGHT” disappears from the front panel display.

The sound effect is turned back on.

Using audio features



Before performing operations, set the operation mode selector on the remote control to **LAMP**.

Enjoying pure hi-fi sound

Use the Pure Direct mode to enjoy the pure high fidelity sound of the selected source. When the Pure Direct mode is activated, this unit plays back the selected source with the least circuitry.

Press **⑰ PURE DIRECT** (or **Ⓟ PURE DIRECT**) to turn the Pure Direct mode on or off.

The **⑰ PURE DIRECT** button lights up while this unit is in the Pure Direct mode. The front panel display automatically dims.

Notes

- The following operations are not possible when this unit is in the Pure Direct mode:
 - switching the sound field program
 - displaying the OSD
 - adjusting the “SET MENU” parameters (except for level settings)
 - operating video functions (video conversion, etc.)
- The Pure Direct mode is automatically canceled whenever this unit is turned off.



The front panel display turns on momentarily when an operation is performed.

Adjusting the tonal quality

Use this feature to adjust the balance of bass and treble for the front left and right speaker channels.



Speaker and headphone adjustments are stored independently.

1 Press **⑬ TONE CONTROL** on the front panel repeatedly to select the high-frequency response (TREBLE) or the low-frequency response (BASS).

2 Rotate the **⑭ PROGRAM** selector to adjust the high-frequency response (TREBLE) or the low-frequency response (BASS).

Notes

- If you increase or decrease the high-frequency or the low-frequency sound to an extreme level, the tonal quality of the surround speakers may not match.
- TONE CONTROL is not effective when PURE DIRECT is selected, or when MULTI CH INPUT is selected as the input source.

Adjusting the speaker level

You can adjust the output level of each speaker while listening to a music source. This is also possible when playing sources input at the MULTI CH INPUT jacks.

Note

This operation will override the level adjustments made in “AUTO SETUP” (see page 28) and “SPEAKER LEVEL” (see page 72).

1 Press **Ⓞ LEVEL** on the remote control repeatedly to select the speaker you want to adjust.

Display	Adjusted speaker
FRONT L	Front left speaker
FRONT R	Front right speaker
CENTER	Center speaker
SWFR	Subwoofer
SUR. L	Surround left speaker
SUR. R	Surround right speaker
SUR. B. L	Surround back left speaker
SUR. B. R	Surround back right speaker
PRNS L	Presence left speaker
PRNS R	Presence right speaker



- Once you press **Ⓞ LEVEL** on the remote control, you can also select the speaker by pressing **Ⓞ Δ / ▽**.
- Instead of “SUR. B. L” and “SUR. B. R”, “SUR. B” is displayed if “SUR. B L/R SP” is set to either “SMLx1” or “LRGx1” (see page 71).
- The available speaker channels differ depending on the setting of the speakers.

2 Press **Ⓞ < / >** to adjust the speaker output level.

- Press **Ⓞ >** to increase the value.
- Press **Ⓞ <** to decrease the value.

Control range: –10.0 dB to +10.0 dB

Enjoying multi-channel sources in 2-channel stereo

You can mix down multi-channel sources to 2 channels and enjoy playback in 2-channel stereo.

Press **Ⓢ** **STEREO** on the remote control repeatedly to select “2ch Stereo”.



- You can use a subwoofer with this program when “LFE/BASS OUT” is set to “SWFR” or “BOTH” (see page 72).
- You can also select the “2ch Stereo” mode by rotating the **Ⓢ** **PROGRAM** selector on the front panel.
- See page 64 for details about the parameters of the “2ch Stereo” mode.

Selecting the night listening mode

The night listening modes are designed to improve listenability at lower volumes or at night.

1 Press **Ⓢ** **NIGHT** on the remote control repeatedly to select “NIGHT:CINEMA” or “NIGHT:MUSIC”.

Choices: NIGHT:CINEMA, NIGHT:MUSIC, OFF

- Select “NIGHT:CINEMA” when watching films to reduce the dynamic range of film soundtracks and make dialog easier to hear at lower volumes.
- Select “NIGHT:MUSIC” when listening to music sources to preserve ease-of-listening for all sounds.
- Select “OFF” if you do not want to use this feature.



When a night listening mode is selected, the NIGHT indicator lights up in the front panel display.

2 Press **Ⓢ** **◀/▶** to adjust the effect level while “NIGHT:CINEMA” or “NIGHT:MUSIC” is displayed in the front panel display.

Effect.Lvl: MID

Choices: MIN, **MID**, MAX

- Select “MIN” for minimum compression.
- Select “MID” for standard compression.
- Select “MAX” for maximum compression.



“NIGHT:CINEMA” and “NIGHT:MUSIC” adjustments are stored independently.

Notes

- You cannot use the night listening modes in the following cases:
 - when the Pure Direct mode (see page 48) is selected.
 - when the component connected to the MULTI CH INPUT jacks is selected as the input source (see page 38).
 - when headphones are connected to the PHONES jack.
- The night listening modes may vary in effectiveness depending on the input source and surround sound settings you use.

FM/AM tuning

There are 2 tuning methods: automatic and manual. Automatic tuning is effective when station signals are strong and there is no interference. If the signal from the station you want to select is weak, tune into it manually. You can also use the automatic and manual preset tuning features to store up to 40 stations (A1 to E8: 8 preset station numbers in each of the 5 preset station groups). Furthermore, you can recall any preset stations and exchange the assignment of two preset stations with each other.

Note

Orient the connected FM and AM antennas for the best reception.

Automatic tuning

Automatic tuning is effective when station signals are strong and there is no interference.

- 1 Rotate the **⑩ INPUT** selector on the front panel to select “TUNER” as the input source.
- 2 Press **③ FM/AM** to select the reception band. “FM” or “AM” appears in the front panel display.
- 3 Press **⑦ TUNING AUTO/MAN'L** so that the **AUTO** indicator lights up in the front panel display.

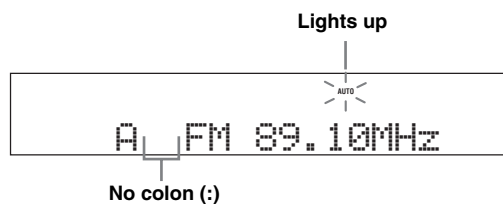

If a colon (:) appears in the front panel display, tuning is not possible. Press **② PRESET/TUNING** to turn the colon (:) off.

- 4 Press **⑤ PRESET/TUNING** **</>** once to begin automatic tuning.

When this unit is tuned into a station, the TUNED indicator lights up and the frequency of the received station is shown in the front panel display.

- Press **⑤ >** to tune into a higher frequency.
- Press **⑤ <** to tune into a lower frequency.

Manual tuning

If the signal received from the station you want to select is weak, tune into it manually.

Note

Manually tuning into an FM station automatically switches the tuner to monaural reception to increase the signal quality.

- 1 Rotate the **⑩ INPUT** selector on the front panel to select “TUNER” as the input source.
- 2 Press **③ FM/AM** to select the reception band. “FM” or “AM” appears in the front panel display.
- 3 Press **⑦ TUNING AUTO/MAN'L** so that the **AUTO** indicator disappears from the front panel display.

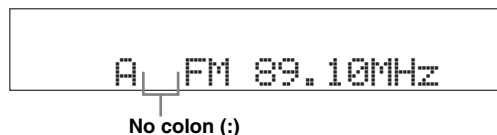

If a colon (:) appears in the front panel display, tuning is not possible. Press **② PRESET/TUNING** to turn the colon (:) off.

- 4 Press **⑤ PRESET/TUNING** **</>** to tune into the desired station manually.



Hold down the button to continue searching.

Automatic preset tuning

You can use the automatic preset tuning feature to store up to 40 FM stations with strong signals (A1 to E8: 8 preset station numbers in each of the 5 preset station groups) in order. You can then recall any preset station easily by selecting the preset station number.

1 Rotate the ⑱ INPUT selector on the front panel to select “TUNER” as the input source.

2 Press ③ FM/AM to select “FM” as the reception band.

“FM” appears in the front panel display.

3 Press and hold ⑥ MEMORY for more than 3 seconds.

The preset station number as well as the MEMORY and AUTO indicators flashes. After approximately 5 seconds, automatic presetting starts from the current frequency and proceeds toward higher frequencies.

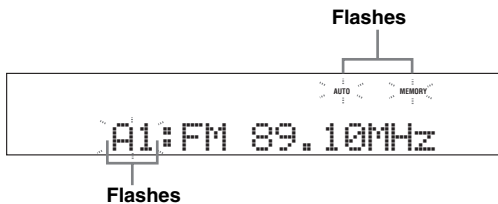

When automatic preset tuning is completed, the front panel display shows the frequency of the last preset station.



- You can specify the preset number from which this unit stores FM stations. Press ④ A/B/C/D/E and then ⑥ PRESET/TUNING < / > repeatedly after you perform step 3 to select the preset station number under which the first station will be stored.
- You can begin tuning toward lower frequencies to store FM stations automatically. Press ② PRESET/TUNING so that the colon (:) disappears from the front panel display and then press ⑥ PRESET/TUNING < / > after pressing and holding ⑥ MEMORY for more than 3 seconds.

Notes

- Any stored station data existing under a preset station number is cleared when you store a new station under the same preset station number.
- If the number of received stations does not reach 40 (E8), automatic preset tuning automatically stops after searching for all the available stations.
- Only FM stations with sufficient signal strength are stored automatically by automatic preset tuning. If the station you want to store is weak in signal strength, tune into it manually and store it as described in “Manual preset tuning” below.
- Only Radio Data System broadcasting stations are stored automatically by automatic preset tuning (Europe model only).

Manual preset tuning

You can also store up to 40 stations (A1 to E8: 8 preset station numbers in each of the 5 preset station groups) manually.

1 Tune into a station.

See page 50 for tuning instructions.

2 Press ⑥ MEMORY on the front panel.

The MEMORY indicator flashes in the front panel display for approximately 10 seconds.

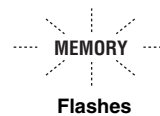

3 Press ④ A/B/C/D/E repeatedly to select a preset station group (A to E) while the MEMORY indicator is flashing.

The selected preset station group letter appears. Check that the colon (:) appears in the front panel display.

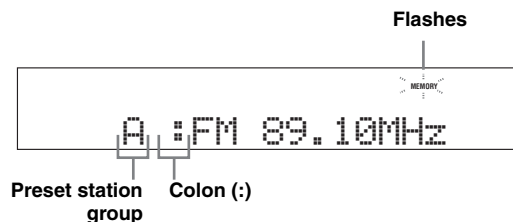

- Press **5** **PRESET/TUNING** $\triangleleft/\triangleright$ to select a preset station number (1 to 8) while the **MEMORY** indicator is flashing.
 - Press **5** \triangleright to select a higher preset station number.
 - Press **5** \triangleleft to select a lower preset station number.

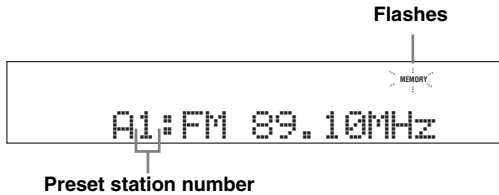

- Press **6** **MEMORY** while the **MEMORY** indicator is flashing.

The station band and frequency appear in the front panel display with the preset station group and number you have selected. The **MEMORY** indicator disappears from the front panel display.

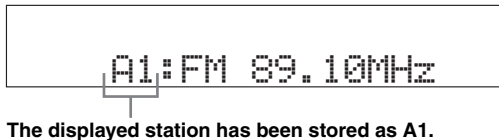

Notes

- Any stored station data existing under a preset station number is cleared when you store a new station under the same preset station number.
- The reception mode (stereo or monaural) is stored along with the station frequency.

Selecting preset stations

You can tune into any desired station simply by selecting the preset station group and number under which it was stored.



When performing this operation with the remote control, set the operation mode selector to **6** **SOURCE** and then press **TUNER** to select "TUNER" as the input source.

- Press **4** **A/B/C/D/E** (or press **0** **A/B/C/D/E** $\triangleleft/\triangleright$) to select the desired preset station group (A to E).

The preset station group letter appears in the front panel display and changes each time you press the button.

- Press **5** **PRESET/TUNING** $\triangleleft/\triangleright$ on the front panel (or **0** **PRESET/CH** \triangle/∇ on the remote control) to select the desired preset station number (1 to 8).

The preset station group and number appear in the front panel display along with the station band and frequency.



Exchanging preset stations

You can exchange the assignments of two preset stations with each other. The example below describes the procedure to exchange preset station "E1" with "A5".

- Select preset station "E1" using **4** **A/B/C/D/E** and **5** **PRESET/TUNING** $\triangleleft/\triangleright$ on the front panel.

See "Selecting preset stations" on the left column.

- Press and hold **2** **EDIT** for more than 3 seconds.

"E1" and the **MEMORY** indicator flash in the front panel display.

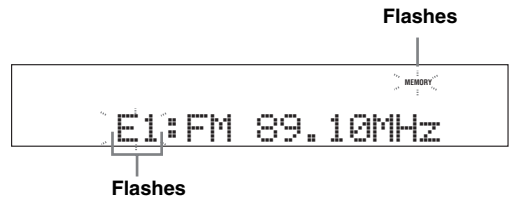

- Select preset station "A5" using **4** **A/B/C/D/E** and **5** **PRESET/TUNING** $\triangleleft/\triangleright$.

"A5" and the **MEMORY** indicator flash in the front panel display.

See "Selecting preset stations" on the left column.

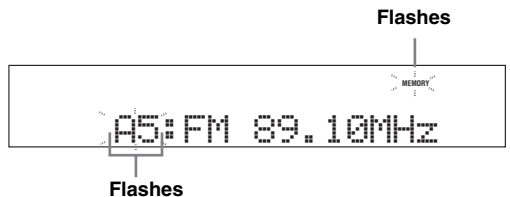

- Press **2** **EDIT** again.

"EDIT E1-A5" appears in the front panel display and the assignments of the two preset stations are exchanged.

Radio Data System tuning (Europe model only)

Radio Data System is a data transmission system used by FM stations in many countries. This unit can receive various Radio Data System data such as PS (program service), PTY (program type), RT (radio text), CT (clock time), and EON (enhanced other networks) when receiving Radio Data System broadcasting stations.

Displaying the Radio Data System information

Use this feature to display the 4 types of the Radio Data System information: PS (program service), PTY (program type), RT (radio text) and CT (clock time). The corresponding indicators light up in the front panel display.

Notes

- You can select one of the Radio Data System display modes only when the corresponding Radio Data System indicator lights up in the front panel display. It may take a while for this unit to receive all of the Radio Data System data from the station.
- You can select only the available Radio Data System display modes being offered by the station.
- If the signals being received are not strong enough, this unit may not be able to utilize the Radio Data System data. In particular, the “RT” mode requires a large amount of data and may not be available even when the other Radio Data System display modes are available.
- In case of poor reception conditions, press **TUNING AUTO/MAN'L** on the front panel so that the AUTO indicator disappears from the front panel display.
- If the signal strength is weakened by external interference while this unit is receiving the Radio Data System data, the reception may be cut off unexpectedly and “...WAIT” appears in the front panel display.
- When the “RT” mode is selected, this unit can display the program information by a maximum of 64 alphanumeric characters, including the umlaut symbol. Unavailable characters are displayed with the “_” (underscore).
- If the reception is cut off when the “CT” mode is selected, “CT WAIT” appears in the front panel display.

1 Tune into the desired Radio Data System broadcasting station.

- We recommend using the automatic preset tuning to tune into the Radio Data System broadcasting stations (see page 51).
- You can also use PTY SEEK mode to tune into the desired Radio Data System broadcasting station from the preset ones.

2 Press **@FREQ/TEXT** on the remote control repeatedly to select the desired Radio Data System display mode.

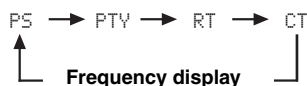

- Select “PS” to display the name of the Radio Data System program currently being received.
- Select “PTY” to display the type of the Radio Data System program currently being received.
- Select “RT” to display the information on the Radio Data System program currently being received.
- Select “CT” to display the current time.

Selecting the Radio Data System program type (PTY SEEK mode)

Use this feature to select the desired radio program by program type from the all preset Radio Data System broadcasting stations.



Use the automatic preset tuning feature to preset Radio Data System broadcasting stations (see page 51).

1 Set the operation mode selector to **ⓁSOURCE** and then press **ⓅTUNER** on the remote control to select “TUNER” as the input source.

2 Press **ⓄBAND** repeatedly to select “FM” as the reception band.

3 Press **ⓈPTY SEEK MODE** on the remote control to set this unit to the **PTY SEEK mode**.

The name of the program type or “NEWS” flashes in the front panel display.

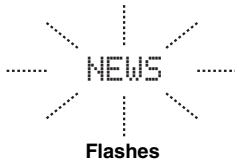

To cancel the PTY SEEK mode, press **ⓈPTY SEEK MODE** on the remote control again.

4 Press **ⓈPRESET/CH** Δ / ∇ on the remote control to select the desired program type.

The name of the selected program type appears in the front panel display.

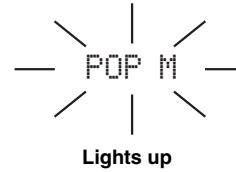

Program type	Descriptions
NEWS	News
AFFAIRS	Current affairs
INFO	General information
SPORT	Sports
EDUCATE	Education
DRAMA	Drama
CULTURE	Culture
SCIENCE	Science
VARIED	Light entertainment
POP M	Popular music
ROCK M	Rock music
M.O.R. M	Middle-of-the-road music (easy-listening)
LIGHT M	Light classics
CLASSICS	Serious classics
OTHER M	Other music

5 Press **ⓄPTY SEEK START** on the remote control to start searching for all the available Radio Data System preset stations.

The name of the selected program type flashes and the PTY HOLD indicator lights up in the front panel display while this unit is searching for stations.

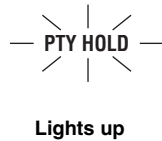
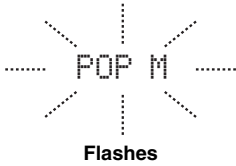

To stop searching for stations, press **ⓄPTY SEEK START** on the remote control again.

Notes

- This unit stops searching for stations when a station broadcasting the selected program type is found.
- If the station found is not the one you desire, press **ⓄPTY SEEK START** again to resume searching for another station broadcasting the same program type.

Using the enhanced other networks (EON) data service

Use this feature to receive the EON (enhanced other networks) data service of the Radio Data System station network. Once you select one of the 4 Radio Data System program types (NEWS, AFFAIRS, INFO, or SPORT), this unit automatically searches for all the available preset stations that are scheduled to broadcast the EON data service of the selected program type for a certain duration of time. When the scheduled EON data service starts, this unit automatically switches to the local station broadcasting the EON data service and then switches back to the national station once the EON data service ends.

Notes

- You can use this feature only when the EON data service is available.
- The EON indicator lights up in the front panel display only when the EON data service is being received from a Radio Data System station.

1 Tune into the desired Radio Data System broadcasting station.

2 Make sure the EON indicator is lit in the front panel display.

If the EON indicator is not lit in the front panel display, select another Radio Data System program so that the EON indicator lights up.



3 Press **ⓄEON** on the remote control repeatedly to select one of the 4 Radio Data System program types (NEWS, AFFAIRS, INFO or SPORT).

The name of the selected program type appears in the front panel display.

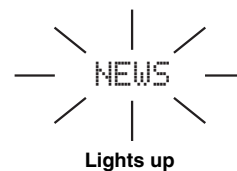

To cancel the EON feature, press EON on the remote control repeatedly until the name of the program type disappears and "EON OFF" appears in the front panel display.

Using iPod™

Once you have stationed your iPod in a Yamaha iPod universal dock (such as the YDS-10, sold separately) connected to the DOCK terminal of this unit (see page 23), you can enjoy playback of your iPod using the supplied remote control. You can also use the Compressed Music Enhancer mode of this unit to improve the sound quality of the compression artifacts (such as the MP3 format) stored on your iPod (see page 46).

Notes

- Only iPod (Click and Wheel), iPod nano, and iPod mini are supported.
- Some features may not be compatible depending on the model or the software version of your iPod.



- For a complete list of the remote control functions used to control your iPod, see the “iPod” column in “Controlling other components” on page 84.
- For a complete list of status messages that appear in the front panel display and in the OSD, see the “iPod” section in “Troubleshooting” on page 107.
- Once the connection between your iPod and this unit is complete, “iPod connected” appears in the front panel display and the DOCK indicator lights up in the front panel display.
- Only the analog audio and video signals of your iPod are input at the DOCK terminal, and the analog audio signals can be output at the analog AUDIO OUT (REC) jacks for recording.
- Your iPod battery is automatically charged when your iPod is stationed in a Yamaha iPod universal dock connected to the DOCK terminal of this unit as long as this unit is turned on. You can also select whether this unit charges the battery of the stationed iPod or not when this unit is in the standby mode by selecting the “STANDBY CHARGE” parameter in “OPTION MENU” (see page 81). The DOCK indicator turns on while this unit charges the battery of the connected iPod when this unit is in the standby mode.

Controlling iPod™

You can control your iPod when “V-AUX” is selected as the input source. The operations of your iPod can be done with the aid of the OSD of this unit (menu browse mode) or without it (simple remote mode).

■ Controlling iPod in the simple remote mode

You can perform the basic operations of your iPod (play, stop, skip, etc.) using the supplied remote control without the aid of the OSD of this unit.



- You can view the photos or video clips stored on your iPod.
- Operations can be also done with the controls on your iPod.

■ Controlling iPod in the menu browse mode

You can perform the advanced operations of your iPod using the supplied remote control with the aid of the OSD of this unit. You can browse the songs stored on your iPod in the OSD. Further, you can change or adjust settings for your iPod to suit your personal preferences.



- The name of the song being played also appears in the front panel display according to the “FL SCROLL” parameter in “OPTION MENU” (see page 79).
- You can select the amount of time the iPod menu and play information is displayed in the OSD by using the “OSD-SOURCE” in “OPTION MENU” (see page 79).

Notes

- Operations cannot be done with the controls on your iPod.
- The YAMAHA logo appears in the display window of your iPod.
- There are some characters that cannot be displayed in the front panel display or in the OSD of this unit. Those characters are replaced with underscores “_”.
- The “Settings” parameters can be changed or adjusted only in the OSD. Press ENTER on the remote control to toggle between the “Settings” parameter settings.
- You cannot browse the photos or video clips stored on your iPod in the OSD. Use the simple remote mode to enjoy watching the photos or video clips stored on your iPod.

- 1 Set the operation mode selector to **L** SOURCE and then press **R** DISPLAY on the remote control.**

The following display appears in the OSD.



- 2 Press **⏪** / **⏩** / **⏮** / **⏭** to navigate the iPod menu and then press **⏵** ENTER to begin playback of the selected song.**

Choices: Playlists (playlists), Artists (artists), Albums (albums), Songs (songs), Genres (genres), Composers (composers), Settings (settings)

- Playlists > Songs
- Artists > Albums > Songs
- Albums > Songs
- Songs
- Genres > Artists > Albums > Songs
- Composers > Albums > Songs
- Settings > Shuffle, Repeat

Shuffle

Use this feature to set this unit to play songs or albums in random order.

Choices: Off, Songs, Albums

- Select "Off" to deactivate this feature.
- Select "Songs" to set this unit to play songs in random order.
- Select "Albums" to set this unit to play albums in random order.



When "Shuffle" is set to a setting other than "Off",  appears in the top right corner while songs or albums are being shuffled.



Repeat

Use this feature to set this unit to repeat one song or a sequence of songs.

Choices: Off, One, All





- Select "Off" to deactivate this feature.
- Select "One" to set this unit to repeat one song.
- Select "All" to set this unit to repeat a sequence of songs.

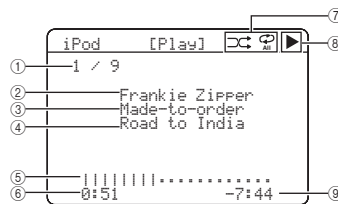

When "Repeat" is set to a setting other than "Off",  or  appears in the top right corner while one song or a sequence of songs are being repeated.

- **The function of the play information display**



- ① Track number/total tracks
- ② Name of the artist
- ③ Name of the album
- ④ Name of the song
- ⑤ Progress bar
- ⑥ Elapsed time
- ⑦ Shuffle and repeat icons
- ⑧  (playback),  (pausing),  (search forward) and  (search backward)
- ⑨ Remaining time

Recording

Recording adjustments and other operations are performed from the recording components. Refer to the operating instructions for those components.

Caution

The DTS signal is a digital bitstream. Attempting to digitally record the DTS bitstream will result in noise being recorded. Therefore, if you want to use this unit to record sources encoded in DTS, the following considerations and adjustments need to be made. To play DTS-encoded DVDs and CDs (when using a digital audio connection) on your DTS-compatible player, follow its operating instructions to make a setting so that the analog signal will be output from the player.

Notes

- When this unit is set to the standby mode, you cannot record between other components connected to this unit.
- TONE CONTROL (see page 48) and VOLUME settings, the speaker level (see page 72) and the sound field programs (see page 42) do not affect recorded material.
- The source connected to the MULTI CH INPUT jacks of this unit cannot be recorded.
- Digital signals input at the DIGITAL INPUT jacks are not output at the analog AUDIO OUT (REC) jacks for recording. Likewise, analog signals input at the AUDIO IN jacks are not output at the DIGITAL OUTPUT jack. Therefore, if your source component is connected to provide only digital or analog signals, you can only record digital or analog signals.
- A given input source is not output on the same OUT (REC) channel.
- S-video and composite video signals pass independently through the video circuits of this unit. Therefore, when recording or dubbing video signals input from a video source component that provides only an S-video or a composite video signal, you can only record an S-video or a composite video signal on your VCR.
- The analog audio signals input at the DOCK terminal can be output at the analog AUDIO OUT (REC) jacks for recording.
- Check the copyright laws in your country to record from CDs, radio, etc. Recording of copyrighted material may infringe copyright laws.



Do a test recording before you start an actual recording.

If you play back a video source that uses scrambled or encoded signals to prevent it from being dubbed, the picture itself may be disturbed due to those signals.

1 Turn on all the connected components.

2 Rotate the **Ⓜ INPUT selector (or press one of the input selector buttons (**Ⓜ**)) to select the source component you want to record from.**

3 Start playback on the selected source component or select a broadcast station.

4 Start recording on the recording component.

Advanced sound configurations

Changing sound field parameter settings

You can enjoy good quality sound with the initial factory settings. Although you do not have to change the initial factory settings, you can change some of the parameters to better suit the input source or your listening room.

Note

You cannot change the sound field parameter values when “MEMORY GUARD” in “OPTION MENU” is set to “ON” (see page 80). If you want to change the sound field parameter values, set “MEMORY GUARD” to “OFF”.

1 Turn on the video monitor connected to this unit.

2 Set the operation mode selector to **LAMP and then press **DISPLAY** on the remote control.**

The following status screen appears in the OSD.

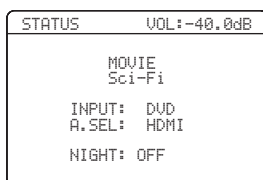

3 Press one of the sound field program selector buttons (⓪) repeatedly to select the desired sound field program you want to adjust.

4 Press **Δ / **∇** to select the desired sound field parameter and then **◀** / **▶** to change the selected sound field parameter value.**

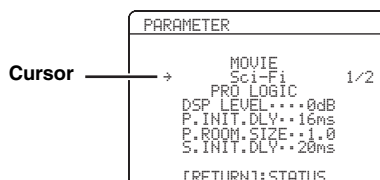

- For details about the function and control range of each sound field parameter, see page 61.
- When you set a sound field parameter to a value other than the initial factory settings, an asterisk mark (*) appears by the sound field parameter name in the OSD.
- The available sound field parameters for some of the sound field programs may be displayed on more than one page in the OSD. In this case, press **Δ** / **∇** to scroll through pages.
- If you press and hold **◀** / **▶** to change the sound field parameter value, the initial factory settings are shown momentarily in the front panel display.
- Use the “PARAM. INI” feature in “OPTION MENU” to initialize the parameters of each sound field program within a sound field program group (see page 80).
- You can select the amount of time that the current status is displayed in the OSD by using the “OSD-AMP” parameter in “OPTION MENU” (see page 79).

5 Press **DISPLAY to turn off the sound field parameter display.**

■ Basic configuration of sound field programs



To change sound field parameter settings, see page 59 for details.

Each sound field program has some parameters defining the characteristics of the program. To customize the selected sound field program, adjust “DSP LEVEL” and/ or “DIALG.LIFT” first, and then try other parameters.

Adjusting the effect sound level of the sound field programs (DSP LEVEL)

Sound field programs add effect sounds (DSP effect sounds) to the original source sound to create sound field in the listening room. Use the “DSP LEVEL” parameter to adjust the level of the effect sounds.

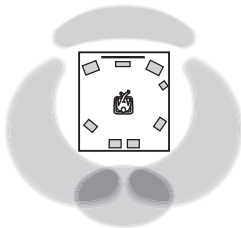

The DSP effect sound level is low.

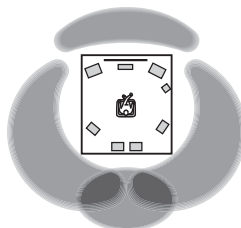

The DSP effect sound level is high.

Adjust “DSP LEVEL” as follows:

Increase the value of “DSP LEVEL” when

- The effect sound of the selected sound field program is too weak.
- You cannot recognize any difference between the sound field programs.

Decrease the value of “DSP LEVEL” when

- The sound is vague.
- You feel that the additional sound effect is excessive.

Control range: -6 dB to +3 dB

Adjusting the vertical dialogue position (DIALG.LIFT)

Use this feature to adjust the vertical position of the dialogues in movies. The ideal position of the dialogues is at the center of the video monitor screen.

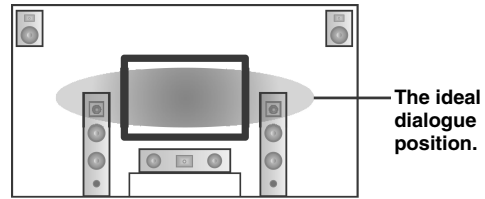

If the dialogues are heard at the lower position of the video monitor screen, increase the value of “DIALG.LIFT”.

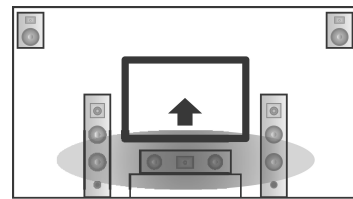

Move up to the ideal dialogue position.

Choices: 0, 1, 2, 3, 4, 5

“0” (initial setting) is the lowest position, and “5” is the highest position.

Notes

- “DIALG.LIFT” is only available only “EXTRA SP ASSIGN” is set to “PRESENCE” (see page 72).
- You cannot move the dialogue position down from the initial dialogue position.

■ Sound field parameters for the advanced configurations

Use the following sound field parameters to customize sound field programs in detail.



To change sound field parameter settings, see page 59 for details.

Sound field parameter	Features
INIT.DLY P.INIT.DLY S.INIT.DLY SB INI.DLY	<p>Initial delay. Presence, surround, and surround back sound field initial delay. Changes the apparent distance from the source sound by adjusting the delay between the direct sound and the first reflection heard by the listener. The smaller the value, the closer the sound source seems to the listener.</p> <p> When you adjust the initial delay parameters, we also recommend adjusting the corresponding room size parameters likewise. This adjustment is especially effective for the CINEMA DSP programs.</p> <hr/> <p>Control range: 1 to 99 ms (INIT.DLY and P.INIT.DLY) 1 to 49 ms (S.INIT.DLY and SB INI.DLY)</p>

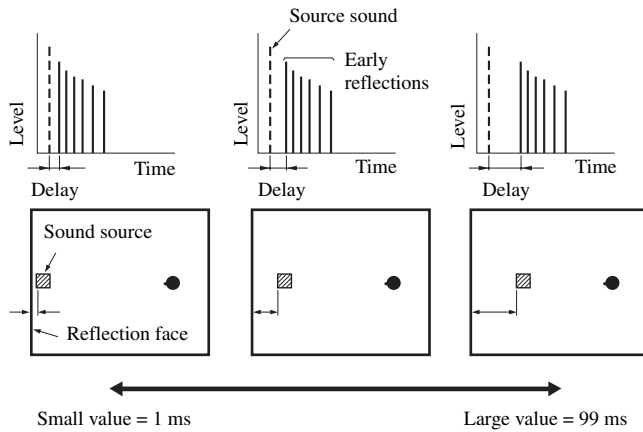

Sound field parameter	Features
ROOM SIZE P. ROOM SIZE S. ROOM SIZE SB ROOM SIZE	<p>Room size. Presence, surround, and surround back room size. Adjusts the apparent size of the surround sound field. The larger the value, the larger the surround sound field becomes. As the sound is repeatedly reflected around a room, the larger the hall is, the longer the time between the original reflected sound and the subsequent reflections. By controlling the time between the reflected sounds, you can change the apparent size of the virtual venue. Changing this parameter from one to two doubles the apparent length of the room.</p> <p>☼</p> <p>When you adjust the room size parameters, we also recommend adjusting the corresponding initial delay parameters likewise. This adjustment is especially effective for the CINEMA DSP programs.</p>

Control range: 0.1 to 2.0

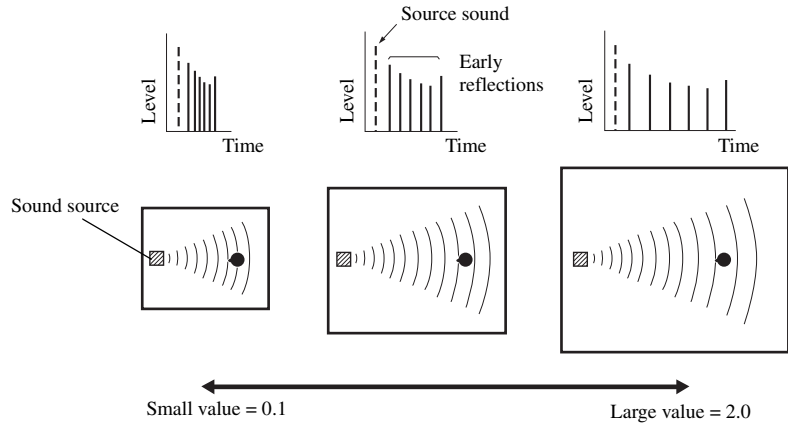

LIVENESS S. LIVENESS SB LIVENESS	<p>Liveness. Surround and surround back sound field liveness. Adjusts the reflectivity of the virtual walls in the hall by changing the rate at which the early reflections decay. The early reflections of a sound source decay much faster in a room with acoustically absorbent wall surfaces than in one which has highly reflective surfaces. A room with acoustically absorbent surfaces is referred to as “dead”, while a room with highly reflective surfaces is referred to as “live”. This parameter lets you adjust the early reflection decay rate and thus the “liveness” of the room.</p>
----------------------------------------	---------------------------------------------------------------------------------------------------------------------------------------------------------------------------------------------------------------------------------------------------------------------------------------------------------------------------------------------------------------------------------------------------------------------------------------------------------------------------------------------------------------------------------------------------------------------------------------------------------

Control range: 0 to 10

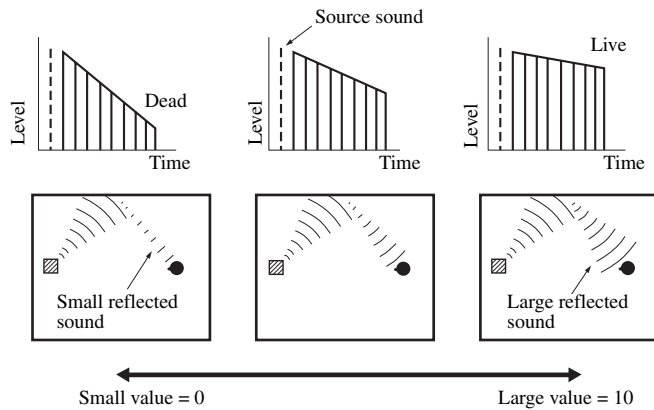

Sound field parameter	Features
-----------------------	----------

REV. TIME

Reverberation time. Adjusts the amount of time taken for the dense, subsequent reverberation sound to decay by 60 dB at 1 kHz. This changes the apparent size of the acoustic environment over an extremely wide range. Set a longer reverberation time for “dead” sources and listening room environments, and a shorter time for “live” sources and listening room environments.

Control range: 1.0 to 5.0 s

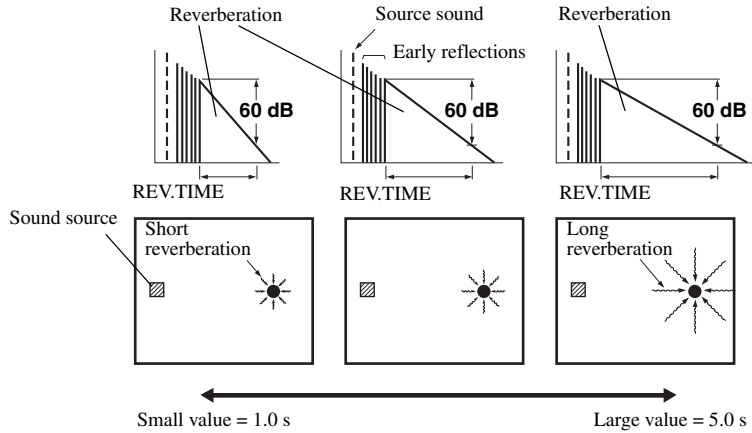

REV. DELAY

Reverberation delay. Adjusts the time difference between the beginning of the direct sound and the beginning of the reverberation sound. The larger the value, the later the reverberation sound begins. A later reverberation sound makes you feel as if you are in a larger acoustic environment.

Control range: 0 to 250 ms

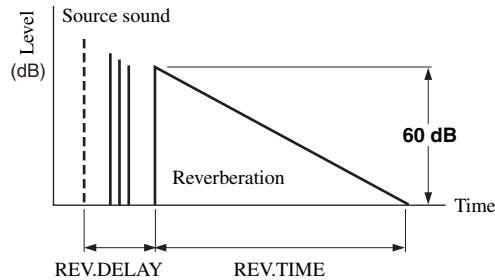

REV. LEVEL

Reverberation level. Adjusts the volume of the reverberation sound. The larger the value, the stronger the reverberation becomes.

Control range: 0 to 100%

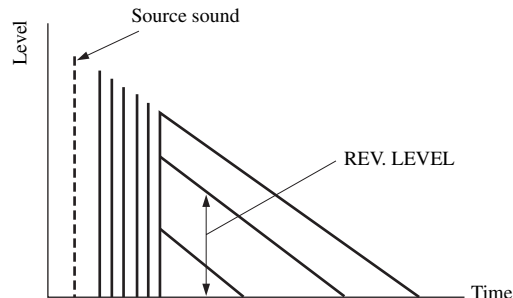

Sound field parameter	Features
2ch Stereo DIRECT	<p>2-channel stereo direct. Bypasses the decoders and the DSP processors of this unit for pure hi-fi stereo sound when playing 2-channel analog sources.</p> <hr/> <p>Choices: AUTO, OFF</p> <hr/> <p></p> <ul style="list-style-type: none"> • Select “AUTO” to bypass the decoders, the DSP processors and the tone control circuitry only when “BASS” and “TREBLE” are set to 0 dB (see page 48). • Select “OFF” not to bypass the decoders, the DSP processors and the tone control circuitry when “BASS” and “TREBLE” are set to 0 dB. • When multi-channel signals (Dolby Digital and DTS) are input, they are downmixed to 2 channels and output from the front left and right speakers. • The low-frequency signals input from the front left and right speakers are redirected to the subwoofer in the following cases: <ul style="list-style-type: none"> – “LFE/BASS OUT” is set to “BOTH” (see page 70). – “FRONT SP” is set to “SMALL” (see page 71) and “LFE/BASS OUT” is set to “SWFR” (see page 70).
7ch Stereo CT LEVEL SL LEVEL SR LEVEL SB LEVEL PL LEVEL PR LEVEL	<p>7-channel stereo center, surround left, surround right, surround back, presence left and presence right levels. Adjusts the volume level of each channel in the 7-channel stereo mode. The available parameters differ depending on the setting of the speakers.</p> <hr/> <p>Control range: 0 to 100%</p>
2ch Enhancer 7ch Enhancer	<p>2-channel and 7-channel Compressed Music Enhancer effect level. The high-frequency signals of some sources may be emphasized too much. In this case, set the effect level to “LOW”.</p> <hr/> <p>Choices: HIGH, LOW</p> <hr/> <ul style="list-style-type: none"> • Select “HIGH” for a high effect level. • Select “LOW” for a low effect level.

■ Selecting decoders used with sound field programs (Decoder Type)

Use this feature to select the desired decoder used with MOVIE sound field programs (except “Mono Movie”). See page 45 for details about MOVIE sound field program.



Available decoders

Decoder	Functions
PRO LOGIC	Dolby Pro Logic processing for any sources
PLIIx Movie PLII Movie	Dolby Pro Logic Iix (or Dolby Pro Logic II) processing for movie sources. The Pro Logic Iix decoder is not available when “SUR. B L/R SP” is set to “NONE” (see page 71).
Neo:6 Cinema	DTS processing for movie sources

Selecting decoders





■ Selecting decoders for 2-channel sources (surround decode mode)

Use this feature to play back sources with selected decoders. You can play back 2-channel sources on multi-channels.

Set the operation mode selector to  AMP and then press  SUR. DECODE repeatedly on the remote control to select the desired surround decoder.

You can select from the following modes depending on the type of source you are playing and your personal preference.









You can change the decoder parameter settings. Press DISPLAY and then  /  repeatedly on the remote control to select the desired decoder parameter. You can change the value of the selected parameter by pressing  < /  repeatedly on the remote control.

Decoder descriptions

Remote control button	Category of the program	Name of the program		
	SURROUND DECODE	PL IIx Music PL II Music		
Dolby Pro Logic IIx (or Dolby Pro Logic II) processing for music sources. The Pro Logic IIx decoder is not available when "SUR. B L/R SP" is set to "NONE" (see page 71).				
PANORAMA	DIMENSION	CENTER WIDTH		

Available sound field parameters (see page 66) Program description

	SURROUND DECODE	PRO LOGIC		
Dolby Pro Logic processing for any sources.				
	SURROUND DECODE	PLIIx Movie PL II Movie		
Dolby Pro Logic IIx (or Dolby Pro Logic II) processing for movie sources. The Pro Logic IIx decoder is not available when "SUR. B L/R SP" is set to "NONE" (see page 71).				
	SURROUND DECODE	PLIIx Music PL II Music		
Dolby Pro Logic IIx (or Dolby Pro Logic II) processing for music sources. The Pro Logic IIx decoder is not available when "SUR. B L/R SP" is set to "NONE" (see page 71).				
PANORAMA	DIMENSION	CENTER WIDTH		
	SURROUND DECODE	PLIIx Game PL II Game		
Dolby Pro Logic IIx (or Dolby Pro Logic II) processing for game sources. The Pro Logic IIx decoder is not available when "SUR. B L/R SP" is set to "NONE" (see page 71).				
	SURROUND DECODE	Neo:6 Cinema		
DTS processing for movie sources.				
	SURROUND DECODE	Neo:6 Music		
DTS processing for music sources.				
C. IMAGE				

 When you select the surround decode mode for Dolby Digital, DTS or DTS 96/24 sources, this unit automatically selects "SURROUND DECODE Dolby Digital", "SURROUND DECODE DTS" or "SURROUND DECODE DTS 96/24" program.

Decoder parameter descriptions

Decoder parameter	Features
PRO LOGIC IIx Music PRO LOGIC II Music PANORAMA	Pro Logic IIx Music and Pro Logic II Music panorama. Sends stereo signals to the surround speakers as well as the front speakers for a wraparound effect. Choices: OFF , ON
PRO LOGIC IIx Music PRO LOGIC II Music DIMENSION	Pro Logic IIx Music and Pro Logic II Music dimension. Adjusts the sound field either towards the front or towards the rear. Control range: -3 (towards the rear) to +3 (towards the front) Initial setting: STD (standard)
PRO LOGIC IIx Music PRO LOGIC II Music CENTER WIDTH	Pro Logic IIx Music and Pro Logic II Music center width. Moves the center channel output completely towards the center speaker or towards the front left and right speakers. A larger value moves the center channel output towards the front left and right speakers. Control range: 0 (center channel sound is output only from the center speaker) to 7 (center channel sound is output only from the front left and right speakers) Initial setting: 3
DTS Neo:6 Music C. IMAGE	DTS Neo:6 Music center image. Adjusts the front left and right channel output relative to the center channel to make the center channel more or less dominant as necessary. Control range: 0.0 to 1.0 Initial setting: 0.3

Customizing this unit (MANUAL SETUP)

You can use the following parameters in “SET MENU” to adjust a variety of system settings and customize the way this unit operates. Change the initial settings (indicated in bold under each parameter) to reflect the needs of your listening environment.

■ Auto setup AUTO SETUP

Use this feature to automatically adjust speaker and system parameters (see page 28).

■ Manual setup MANUAL SETUP

Use this feature to manually adjust speaker and system parameters.

Sound menu 1 SOUND MENU

Use this menu to manually adjust any speaker settings, alter the quality and tone of the sound output by the system or compensate for video signal processing delays when using LCD monitors or projectors.

Parameter	Features	Page
A)SPEAKER SET	Selects the size of each speaker, the speakers for low-frequency signal output, the crossover frequency, and the assignment of the EXTRA SP terminal.	70
B)SPEAKER LEVEL	Adjusts the output level of each speaker.	72
C)SP DISTANCE	Adjusts the distance of each speaker.	73
D)EQUALIZER	Adjusts the tonal quality of the center speaker.	73
E)LFE LEVEL	Adjusts the output level of the LFE channel for Dolby Digital or DTS signals.	74
F)DYNAMIC RANGE	Adjusts the dynamic range of Dolby Digital or DTS signals.	74
G)AUDIO SET	Adjusts the muting level, audio delay, maximum volume level and initial volume level.	74
H)HDMI SET	Selects the component to play back HDMI audio signals.	75
I)EXTD SUR.	Selects the mode of the decoders for the 6.1/7.1-channel playback.	75

Input menu 2 INPUT MENU

Use this menu to manually reassign the input/output jacks, select the input mode or rename the input source.

Parameter	Features	Page
A)I/O ASSIGNMENT	Assigns the input/output jacks of this unit according to the component to be used.	76
B)INPUT RENAME	Changes the name of the input source.	77
C)VOLUME TRIM	Adjusts the output volume of each input source.	78
D)DECODER MODE	Selects the input mode for the sources connected to the DIGITAL INPUT jacks on the rear panel of this unit.	78
E)MULTI CH SET	Sets the input channel numbers and other parameters of the input multi channel.	78

Option menu 3 OPTION MENU

Use this menu to manually adjust the optional system parameters.

Parameter	Features	Page
A>DISPLAY SET	Adjusts the brightness of the display and converts video signals.	79
B>MEMORY GUARD	Locks sound field program parameters and other "SET MENU" settings.	80
C>AUDIO SELECT	Designates the default audio input jack select setting mode for the input sources when you turn on the power of this unit.	80
D>PARAM. INI	Initializes the parameters of a group of sound field programs.	80
E>ZONE 2 SET	Adjusts the Zone 2 parameters.	80
F>DOCK SET	Selects whether this unit charges the battery of the connected iPod or not when this unit is in the standby mode.	81

■ Signal information SIGNAL INFO

Use this feature to check audio and video signal information (see page 40).

Using SET MENU

Use the remote control to access and adjust each parameter.



- You can change the “SET MENU” parameters while this unit is reproducing sound.
- Press **RETURN** to return to the previous menu level.

1 Set the operation mode selector to **LAMP** and then press **SET MENU** to enter “SET MENU”.

The top “SET MENU” display appears in the OSD.

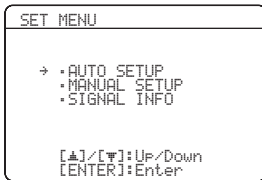

2 Press **Up/Down** to select “MANUAL SETUP” and then **ENTER** to enter “MANUAL SETUP”.

The “MANUAL SETUP” display appears in the OSD.

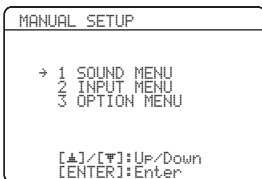

3 Press **Up/Down** repeatedly and then press **ENTER** to select and enter the desired menu.

The following displays are examples where “SOUND MENU” is selected.

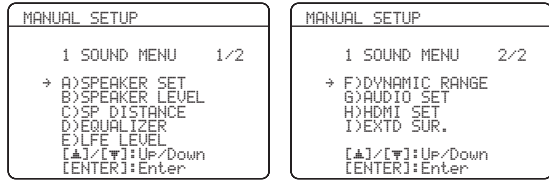

4 Press **Up/Down** repeatedly and then press **ENTER** to select and enter the desired submenu.

The following display is an example where “LFE LEVEL” is selected.



5 Press **Up/Down** to select the desired parameter and then **Left/Right** to change the parameter settings.

6 Press **SET MENU** to exit from “SET MENU”.

1 SOUND MENU

Use this feature to manually adjust speaker settings or compensate for video signal processing delays when using LCD monitors or projectors. Most of the SOUND MENU parameters are set automatically when you run AUTO SETUP (see page 28).

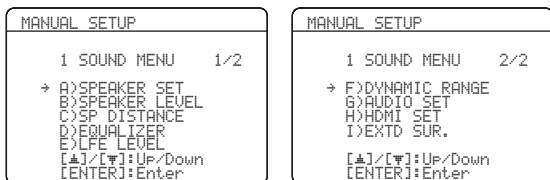

■ Speaker settings A) SPEAKER SET

Use this feature to manually adjust any speaker settings.

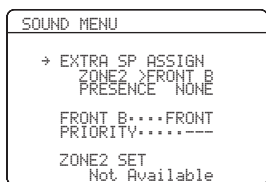

Extra speakers assignment EXTRA SP ASSIGN

Selects the function of the speakers connected to the EXTRA SP terminals.

Choices: **FRONT B**, ZONE2, PRESENCE, NONE

When you use the alternative front speaker system (see page 38)

Select “FRONT B”.

When you use the Zone 2 speakers (see page 96)

Select “ZONE2” to set the function of the speakers to the Zone 2 speakers.

When you use the presence speakers (see page 12)

Select “PRESENCE” to set the function of the speakers to the presence speakers.

When you do not use the EXTRA SP terminals

Select “NONE” to deactivate the EXTRA SP terminals.

Notes

- This parameter shares the value with the “EXTRA SP ASSIGN” parameter in “AUTO SETUP”.
- If you select “ON” in “BI-AMP” (see page 101), you cannot select “PRESENCE” or “ZONE2” in “EXTRA SP ASSIGN”.
- After changing the “EXTRA SP ASSIGN” setting, carry out “AUTO SETUP” again (see page 28).

FRONT B speakers setting FRONT B

The “FRONT B” parameter is available only when you set “EXTRA SP ASSIGN” to “FRONT B”.

Use this feature to select the location of the FRONT B speakers.

Choices: **FRONT**, ZONE B

- Select “FRONT” to turn FRONT A and B on or off when the FRONT B speakers are set in the main room.
- Select “ZONE B” if the FRONT B speakers are set in another room. If FRONT A is turned off and FRONT B is turned on, all the speakers including the subwoofer in the main room are muted and this unit outputs sound at the FRONT B terminals only.

Notes

- If you connect headphones to the PHONES jack of this unit, the sound is output from both the headphones and the EXTRA SP terminals when “FRONT B” is set to “ZONE B”.
- If a DSP program is selected when “FRONT B” is set to “ZONE B”, this unit automatically enters the Virtual CINEMA DSP mode (see page 46).

Presence/Surround back channel priority PRIORITY

The “PRIORITY” parameter is available only when you set “EXTRA SP ASSIGN” to “PRESENCE”.

Use this feature to prioritize either the presence or the surround back speakers when playing sources that contain surround back channel signals using the CINEMA DSP sound field programs.

Choices: PRNS, **SUR. B**

- Select “PRNS” to use the presence speakers even when surround back channel signals are input. The signals for the surround back channels will be output from the surround speakers.
- Select “SUR. B” to use the surround back speakers when surround back channel signals are detected in a CINEMA DSP program. The presence channel signals are output from the front speakers.

Woofers section of a speaker is 16 cm (6.5 in) or larger: large
 Woofers section of a speaker is smaller than 16 cm (6.5 in): small

Front speakers FRONT SP

Choices: SMALL, **LARGE**

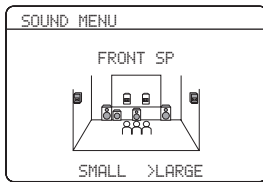

When the front speakers are large

Select "LARGE" (large).

When the front speakers are small

Select "SMALL" (small).

Note

When "LFE/BASS OUT" is set to "FRNT" (see page 70), you can select only "LARGE" in "FRONT SP". If the value of "FRONT SP" is set to a setting other than "LARGE" in advance, this unit automatically changes the value to "LARGE".

Center speaker CENTER SP

Choices: NONE, **SML**, LRG

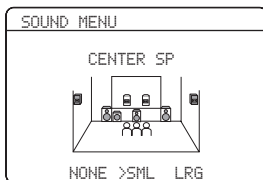

When the center speaker is large

Select "LRG" (large).

When the center speaker is small

Select "SML" (small).

When you do not use the center speaker

Select "NONE" (none). The center channel signals are directed to the front left and right speakers.

Surround left/right speakers SUR. L/R SP

Choices: NONE, **SML**, LRG

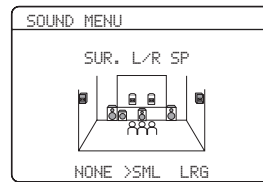

When the surround speakers are large

Select "LRG" (large).

When the surround speakers are small

Select "SML" (small).

When you do not use the surround speakers

Select "NONE" (none). This unit is set to the Virtual CINEMA DSP mode (see page 46), and "SUR. B L/R SP" is automatically set to "NONE".

Surround back left/right speakers SUR. B L/R SP

Choices: NONE, SMLx1, **SMLx2**, LRGx1, LRGx2

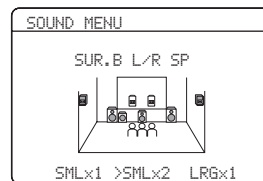

When the surround back left and right speakers are large

Select "LRGx2" (large x 2).

When the single surround back speaker is large

Select "LRGx1" (large x 1).

When the surround back left and right speakers are small

Select "SMLx2" (small x 2).

When the single surround back speaker is small

Select "SMLx1" (small x 1).

When you do not use the surround back speakers

Select "NONE" (none). The surround back channel signals are directed to the surround left and right speakers.

LFE/Bass out LFE/BASS OUT

Use this feature to select the speakers that output the LFE (low-frequency effect) and the low-frequency signals.

Choices: SWFR, FRNT, **BOTH**

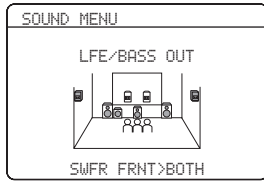

When a subwoofer is connected to this unit and you want to get natural bass sound

Select “SWFR” (subwoofer). The LFE signals as well as the low-frequency signals of other speakers set to “SML” (or “SMALL”) are directed to the subwoofer.

When a subwoofer is connected to this unit and you want to get rich bass sound

Select “BOTH” (both). The low-frequency signals of any source are output from the subwoofer. The LFE signals as well as the low-frequency signals of other speakers set to “SML” (or “SMALL”) are directed to the subwoofer. The low-frequency signals of the front left and right channels are directed to the front left and right speakers and the subwoofer regardless of the “FRONT SP” setting.

When you do not use a subwoofer

Select “FRNT” (front). The LFE signals, the low-frequency signals of the front left and right channels, and the low-frequency signals of other speakers set to “SML” (or “SMALL”) are all directed to the front left and right speakers regardless of the “FRONT SP” setting.

Bass crossover CROSSOVER

Use this feature to select the crossover frequency of all the speakers set to “SML” (or “SMALL”) or to “NONE” in “SPEAKER SET” (see page 71). All frequencies below the selected frequency will be sent to the subwoofer or to the speakers set to “LRG” (or “LARGE”) in “SPEAKER SET” (see page 71).

Choices: 40Hz, 60Hz, **80Hz**, 90Hz, 100Hz, 110Hz, 120Hz, 160Hz, 200Hz

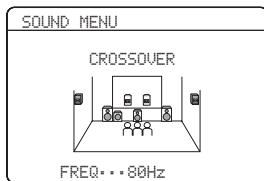

Subwoofer phase SUBWOOFER PHASE

Use this feature to switch the phase of your subwoofer if bass sounds are lacking or unclear.

Choices: **NORMAL**, REVERSE

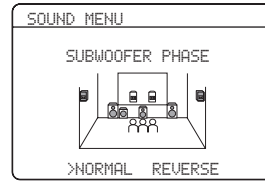

- Select “NORMAL” if you do not want to reverse the phase of your subwoofer.
- Select “REVERSE” to reverse the phase of your subwoofer.

■ **Speaker level** B>SPEAKER LEVEL

Use this feature to manually adjust the output level of each speaker.

Control range: –10.0 to +10.0 dB

Control step: 0.5 dB

Initial setting: 0.0 dB

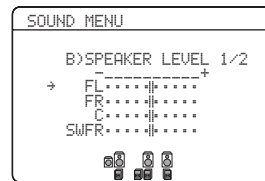

SPEAKER LEVEL	Adjusted speaker
FL	Front left speaker
FR	Front right speaker
C	Center speaker
SWFR	Subwoofer
SL	Surround left speaker
SR	Surround right speaker
SBR	Surround back right speaker
SBL	Surround back left speaker
PL	Presence left speaker
PR	Presence right speaker

Notes

- The available speaker channels differ depending on the setting of the speakers.
- Instead of “SBL” and “SBR”, “SB” is displayed if “SUR. B L/R SP” is set to either “SMLx1” or “LRGx1” (see page 71).

■ Speaker distance C)SP DISTANCE

Use this feature to manually adjust the distance of each speaker and the delay applied to the respective channel. Ideally, each speaker should be the same distance from the main listening position. However, this is not possible in most home situations. Thus, a certain amount of delay must be applied to the sound from each speaker so that all sounds will arrive at the listening position at the same time.

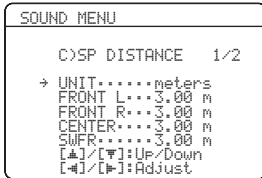

Unit UNIT

Choices: meters (m), feet (ft)

Initial setting:

[U.S.A. and Canada models]: feet (ft)

[Other models]: meters (m)

- Select “meters” to adjust speaker distances in meters.
- Select “feet” to adjust speaker distances in feet.

Speaker distances

Control range: 0.30 to 24.00 m (1.0 to 80.0 ft)

Control step: 0.10 m (0.5 ft)

Initial setting:

FRONT L/FRONT R/CENTER/SWFR/SUR. L/SUR. R/

PRNS L/PRNS R: 3.00 m (10.0 ft)

SB L/SB R: 2.10 m (7.0 ft)

SP DISTANCE	Adjusted speaker
FRONT L	Front left speaker
FRONT R	Front right speaker
CENTER	Center speaker
SWFR	Subwoofer
SUR. L	Surround left speaker
SUR. R	Surround right speaker
SB L	Surround back left speaker
SB R	Surround back right speaker
PRNS L	Presence left speaker
PRNS R	Presence right speaker

Notes

- The available speaker channels differ depending on the setting of the speakers.
- Instead of “SB L” and “SB R”, “SB” is displayed if “SUR. B L/ R SP” is set to either “SMLx1” or “LRGx1” (see page 71).

■ Equalizer D)EQUALIZER

Use this feature to select the parametric equalizer or the graphic equalizer.

Equalizer type select EQ TYPE SELECT

Use this feature to select the type of equalizer.

Choices: AUTO PEQ, CENTER GEQ, EQ OFF

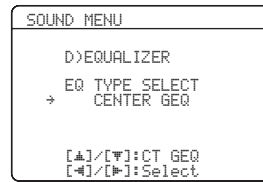

- Select “AUTO PEQ” to use the parametric equalizer adjusted in “AUTO SETUP” (see page 28).
- Select “CENTER GEQ” to adjust the built-in 5-frequency band graphic equalizer so that the tonal quality of the center speaker matches that of the front left and right speakers. Press \odot / Δ / ∇ to display the graphic equalizer screen.
- Select “EQ OFF” to deactivate the equalizing feature.

Note

When you carry out “AUTO SETUP” in advance (see page 28), “AUTO PEQ” is automatically selected as the default setting.

Test tone TEST

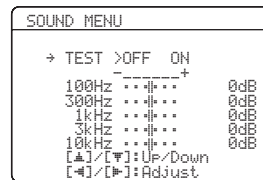

Use this feature to make adjustments for “CENTER GEQ” while listening to a test tone.

Choices: OFF, ON

- Select “OFF” to stop test tones and output the currently selected source component.
- Select “ON” to output test tones from the center and front left speakers.

Center graphic equalizer CENTER GEQ

Use to match the tonal quality of the center speaker with that of the front left and right speakers. You can adjust 5 frequency bands (100 Hz, 300 Hz, 1 kHz, 3 kHz and 10 kHz).

Control range: -6.0 to +6.0 dB

Control step: 0.5 dB

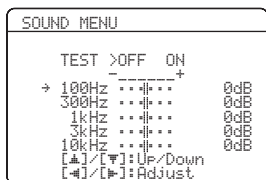

Press **⏮**/**⏭** to select a frequency band and **⏪**/**⏩** to adjust the selected frequency band.

Note

The “CENTER GEQ” parameter can be adjusted only when “CENTER GEQ” is selected in “EQ TYPE SELECT”.

Low-frequency effect level

E>LFE LEVEL

Use this feature to adjust the output level of the LFE (low-frequency effect) channel according to the capacity of your subwoofer or headphones. The LFE channel carries low-frequency special effects which are only added to certain scenes. This setting is effective only when this unit decodes Dolby Digital or DTS signals.

Control range: -20 to 0 dB

Control step: 1 dB



Speaker SPEAKER

Adjusts the speaker LFE level.

Headphone HEADPHONE

Adjusts the headphone LFE level.

Note

Depending on the settings of “LFE/BASS OUT” (see page 70), some signals may not be output at the SUBWOOFER OUTPUT jack.

Dynamic range F>DYNAMIC RANGE

Use this feature to select the amount of dynamic range compression to be applied to your speakers or headphones. This setting is effective only when this unit is decoding Dolby Digital and DTS signals.

Choices: MIN, STD, **MAX**

- Select “MIN” (minimum) if you regularly listen at low volume levels.
- Select “STD” (standard) for general use.
- Select “MAX” (maximum) to preserve the greatest amount of dynamic range.

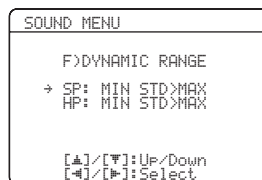

Speaker SP

Adjusts the speaker compression.

Headphone HP

Adjusts the headphone compression.

Audio settings G>AUDIO SET

Use this feature to adjust the overall audio settings of this unit.

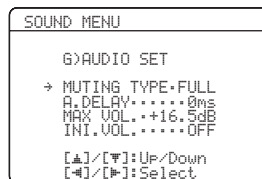

Muting type MUTING TYPE

Use this feature to adjust how much the mute function reduces the output volume (see page 40).

Choices: **FULL**, -20dB

- Select “FULL” to completely mute all the audio output.
- Select “-20dB” to reduce the current volume by 20 dB.

Audio delay AUDIO DELAY

Use this feature to delay the sound output and synchronize it with the video image. This may be necessary when using certain LCD monitors or projectors.

Control range: 0 to 160 ms

Control step: 1 ms

Maximum volume MAX VOL.

Use this feature to set the maximum volume level in the main zone. This feature is useful to avoid the unexpected loud sound by mistake. For example, the original volume range is 16.5 dB to -80.0 dB. However, when “MAX VOL.” is set to -5.0 dB, the volume range becomes -5.0 dB to -80.0 dB.

Control range: **16.5 dB**, 15.0 dB to -30.0 dB

Control step: 5.0 dB

Notes

- When this unit is in the auto setup procedure, the volume level is automatically set to 0 dB regardless of the current “MAX VOL.” setting.
- The “MAX VOL.” setting takes priority over the “Initial Volume” setting. For example, if “INI VOL.” is set to -20.0 dB and “MAX VOL.” is set to -30.0 dB, the volume level is automatically set to -30.0 dB when you turn on the power of this unit next time.
- Use “MAX VOL.” in “ZONE2 SET” to set the initial volume level in Zone 2 (see page 81).

Initial volume INI VOL.

Use this feature to set the volume level of the main zone when the power of this unit is turned on.

Choices: **Off**, -80.0 dB to +16.5 dB

Control step: 0.5 dB

Notes

- The “MAX VOL.” setting takes priority over the “INI VOL.” setting.
- Use “INI VOL.” in “ZONE2 SET” to set the initial volume level in Zone 2 (see page 81).

HDMI setting H>HDMI SET

Use this feature to select the component to play back HDMI audio signals.

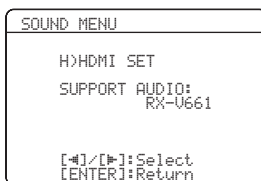
**Support audio** SUPPORT AUDIO

Use this feature to select whether to play back HDMI audio signals on this unit or on another HDMI component connected to the HDMI OUT jack on the rear panel of this unit.

Choices: **RX-V661**, OTHER

- Select “RX-V661” to play back HDMI audio signals on this unit. The HDMI audio signals input at the HDMI IN jacks of this unit are not output to the HDMI component connected to the HDMI OUT jack on the rear panel of this unit.
- Select “OTHER” to play back HDMI audio signals on another HDMI component connected to the HDMI OUT jack.

Note

The HDMI video signals input at the HDMI IN 1 or HDMI IN 2 jack of this unit are always output at the HDMI OUT jack of this unit.

Extended surround decoders

I>EXTD SUR.

Use this feature to enjoy 6.1/7.1-channel playback for multi-channel sources using the Dolby Pro Logic IIX, Dolby Digital EX or DTS-ES decoders by using the connected surround back speakers.

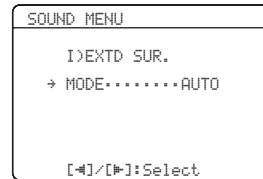
**Mode** MODE

Use this feature to select the mode of the decoder driving. Choices: **AUTO**, ON, OFF

- Select “AUTO” to activate the optimum decoder to play back the signal in 6.1/7.1 channels when a signal flag that can be recognized by this unit is input.
- Select “ON” to play back multi-channel sources using the selected decoder type in “TYPE”.
- Select “OFF” not to use the decoders to create 6.1/7.1 channels.

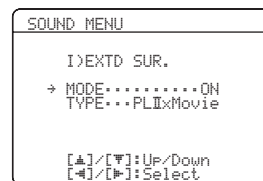
Decoder type TYPE

Use this feature to select the decoders used to play back multi-channel sources when you select “ON” in “MODE”.

Choices: **PLIIXMovie**, PLIIXMusic, EX/ES, EX

- Select “PLIIXMovie” to play back Dolby Digital or DTS signals in 7.1 channels using the Pro Logic IIX movie decoder.
- Select “PLIIX Music” to play back Dolby Digital or DTS signals in 6.1/7.1 channels using the Pro Logic IIX music decoder.
- Select “EX/ES” to play back Dolby Digital or DTS signals in 6.1/7.1 channels using the Dolby Digital EX or DTS-ES decoder.
- Select “EX” to play back Dolby Digital or DTS signals in 6.1/7.1 channels using the Dolby Digital EX decoder.



Use this feature to activate the desired decoder manually when this unit cannot detect the signal flag encoded to the input sources correctly.

Notes

- The available decoders vary depending on the setting of the speakers and the input sources.
- 6.1/7.1-channel playback is not possible in the following cases:
 - when “SUR. L/R SP” (see page 71) or “SUR. B L/R SP” (see page 71) is set to “NONE”.
 - when the component connected to the MULTI CH INPUT jacks is being played.
 - when the source being played does not contain surround left and right channel signals.
 - when a Dolby Digital KARAOKE source is being played.
 - when the stereo playback, Compressed Music Enhancer (see page 46) or Pure Direct (see page 48) mode is selected.
 - when “BI-AMP” is set to “ON” (see page 101).
- When this unit is turned off, this setting will be reset to “AUTO”.

2 INPUT MENU

Use this menu to reassign the input/output jacks, select the input mode or rename the input source.

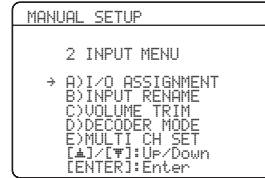

■ **Input/output assignment**

A) I/O ASSIGNMENT

Use this feature to assign the input/output jacks according to the component to be used if the initial settings of this unit do not correspond to your needs. Change the following parameters to reassign the respective jacks and effectively connect more components.

Once the input/output jacks are reassigned, you can select the corresponding component by using the INPUT selector on the front panel (or the input selector buttons on the remote control).



The input source name in parentheses indicates the default assigned input source.

For COMPONENT VIDEO jacks A, B and C

CMPNT-V INPUT

- Choices: [A] **DVD**, DTV/CBL, V-AUX, DVR, VCR
 [B] DVD, **DTV/CBL**, V-AUX, DVR, VCR
 [C] DVD, DTV/CBL, V-AUX, **DVR**, VCR

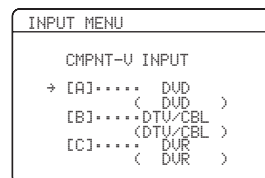

For OPTICAL OUTPUT jack 1

OPTICAL OUT

Choices: (1) PHONO, CD, **MD/CD-R**, DVD, DTV/CBL, V-AUX, VCR, DVR

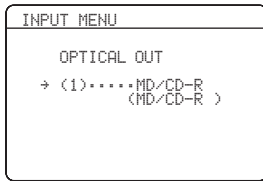

Notes

- You cannot select a specific item more than once for the same type of jack.
- When you connect a component to both the DIGITAL INPUT (COAXIAL) and DIGITAL INPUT (OPTICAL) jacks, priority is given to the signals input at the DIGITAL INPUT (COAXIAL) jack.

For OPTICAL INPUT jacks 2, 3 and 4

OPTICAL IN

Choices: (2) PHONO, CD, **MD/CD-R**, DVD, DTV/CBL, DVR, VCR

(3) PHONO, CD, MD/CD-R, **DVD**, DTV/CBL, DVR, VCR

(4) PHONO, CD, MD/CD-R, DVD, **DTV/CBL**, DVR, VCR

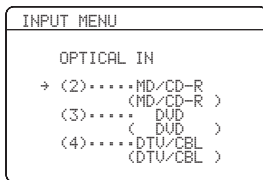

For COAXIAL INPUT jacks 5 and 6

COAXIAL IN

Choices: (5) PHONO, **CD**, MD/CD-R, DVD, DTV/CBL, V-AUX, DVR, VCR

(6) PHONO, CD, MD/CD-R, **DVD**, DTV/CBL, V-AUX, DVR, VCR

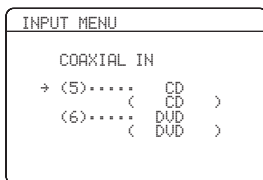

For HDMI IN jacks 1 and 2

HDMI IN

Choices: [IN1] **DVD**, DTV/CBL, V-AUX, DVR, VCR

[IN2] **DVD**, **DTV/CBL**, V-AUX, DVR, VCR

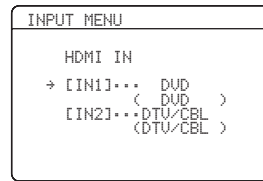

Input rename B)INPUT RENAME

Use this feature to change the name of the input source that appears in the OSD and in the front panel display.

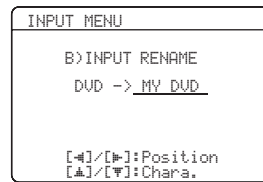

- This feature is useful when you change the input or output assignment for digital jacks and component video input jacks.
- You can only rename DOCK when iPod is stationed in the Yamaha Universal Dock connected to this unit.

- 1 Press one of the input selector buttons (Ⓢ) on the remote control to select the input source you want to change the name of.
- 2 Press Ⓢ◀/▶ to place the “_” (underscore) under the space or the character you want to edit.
- 3 Press Ⓢ▲/▼ to select the character you want to use and then press Ⓢ◀/▶ to move to the next space.

Notes

- You can use up to 8 characters for each input.
- Press Ⓢ▼ to change the character in the following order, or press Ⓢ▲ to go in the reverse order:
A to Z, 0 to 9, a to z, symbols (#, *, -, +, etc.), space.

- 4 Repeat steps 1 through 3 to rename each input source.
- 5 Press ⓈENTER on the remote control to exit from “INPUT RENAME”.

■ **Volume Trim** C>VOLUME TRIM

Use this feature to adjust the output level of each input source. This is useful if you want to balance the level of each input source to avoid sudden changes in volume when switching between input sources.

Choices: TUNER, PHONO, CD, MD/CD-R, DVD, DTV/CBL, VCR, DVR, V-AUX, DOCK, MULTI CH

Control range: -6.0 to +6.0 dB

Control step: 0.5 dB

Initial setting: 0.0 dB

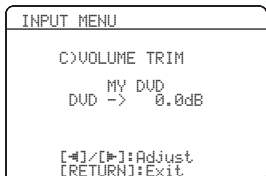

- You can adjust the value for DOCK only when iPod is stationed to the Yamaha Universal Dock connected to this unit.
- The default name (“DVD” in the display example above) and the new name (“MY DVD”) of the selected input source appears in the OSD.

■ **Decoder mode** D>DECODER MODE

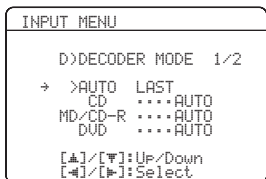

Decoder select mode

Use this feature to designate the default decoder mode for the input sources connected to the DIGITAL INPUT jacks when you turn on the power of this unit.

Choices: **AUTO**, LAST

- Select “AUTO” to if you want this unit to automatically detect the type of input signals and select the appropriate decoder mode.
- Select “LAST” to if you want this unit to automatically select the last decoder mode used for the connected input source.

DTS decoder prioritize setting

Choices: **AUTO**, DTS

- Select “AUTO” if you want this unit to automatically detect input signal types and select the appropriate input mode.
- Select “DTS” if you want this unit to select DTS as the input mode.

■ **Multi channel input settings**

E>MULTI CH SET

Use this feature to set the function of the multi channel input.

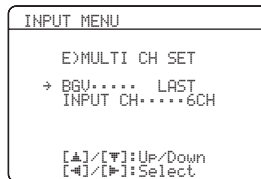

BGV BGV

Use this feature to select the video source played in the background of the sources input from the MULTI CH INPUT jacks.

Choices: DVD, DTV/CBL, V-AUX, DVR, VCR, **LAST**, OFF

- Select “LAST” to set this unit to automatically select the last selected video source as the background video source.
- Select “OFF” to set this unit not to play the video source in the background.

Input channels INPUT CH

Use this setting to select the number of channels input from an external decoder.

Choices: **6CH**, 8CH

- Select “6CH” if you input 6-channel signals.
- Select “8CH” if you input 8-channel signals.

Front input FRONT

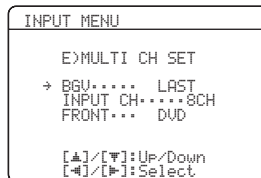

If you selected “8CH” in “INPUT CH”, you can select the analog jacks at which the front signals from an external decoder will be input.

Choices: CD, MD/CD-R, **DVD**, DTV/CBL, V-AUX, DVR, VCR



See page 22 for the connection information.

Note

The “FRONT” parameter appears only when you set “INPUT CH” to “8CH”.

3 OPTION MENU

Use this menu to adjust the optional system parameters.

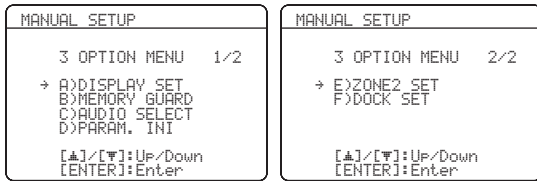

■ Display settings A)DISPLAY SET

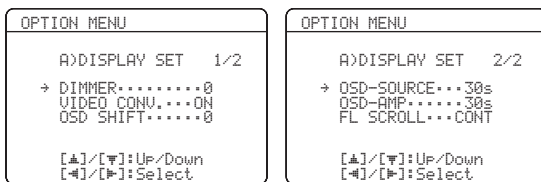

Dimmer DIMMER

Use this feature to adjust the brightness of the front panel display.

Control range: -4 to 0

Control step: 1

- Press **⊖** to make the front panel display dimmer.
- Press **⊕** to make the front panel display brighter.

Video conversion VIDEO CONV.

Use this feature to set whether to convert the video signals input at the VIDEO, S VIDEO and COMPONENT VIDEO jacks.

Choices: **ON**, **OFF**

- Select “ON” to convert composite, S-video and component video signals interchangeably.
- Select “OFF” not to convert any signals.

Notes

- This unit does not convert 480 line video signals and 576 line video signals interchangeably.
- The converted video signals are only output at the MONITOR OUT jacks. When recording a video source, you must make the same type of video connections between each component.
- When composite video or S-video signals from a VCR are converted to component video signals, the picture quality may suffer depending on your VCR.
- Unconventional signals input at the composite video or S-video jacks cannot be converted or may be output abnormally. In such cases, set “VIDEO CONV.” to “OFF”.
- When non-standard video signals (such as video signals from a game console) are input, this unit may not convert the signals even if you set “VIDEO CONV.” to “ON”.

OSD shift OSD SHIFT

Use this feature to adjust the vertical position of the OSD.

Control range: -5 (upward) to +5 (downward)

Control step: 1

Initial setting: 0

- Press **⊖** to raise the position of the OSD.
- Press **⊕** to lower the position of the OSD.

Source feature OSD display time

OSD-SOURCE

Use this feature to set the amount of time to display the iPod menu in the OSD after you perform a certain operation.

Choices: **ON**, 10s, **30s**

- Select “ON” to display the OSD continuously during an operation.
- Select “10s” to turn off the OSD 10 seconds after you perform a certain operation.
- Select “30s” to turn off the OSD 30 seconds after you perform a certain operation.

Amplifier function OSD display time

OSD-AMP

Use this feature to set the amount of time to display the status and sound field parameters information screen after you perform a certain operation.

Choices: **ON**, 10s, **30s**

- Select “ON” to display the OSD constantly during an operation.
- Select “10s” to turn off the OSD 10 seconds after you perform a certain operation.
- Select “30s” to turn off the OSD 30 seconds after you perform a certain operation.

Front panel display scroll FL SCROLL

Use this feature to set whether to display the information (such as a song title or a channel name) in the front panel display in a continuous manner or by the first 14 alphanumeric characters after scrolling all characters once when “DOCK” is selected as the input source.

Choices: **CONT**, **ONCE**

- Select “CONT” to display the operation status in the front panel display in a continuous manner.
- Select “ONCE” to display the operation status in the front panel display by the first 14 alphanumeric characters after scrolling all characters once.

■ Memory guard B>MEMORY GUARD

Use this feature to prevent accidental changes to DSP program parameter values and other system settings.

Choices: **OFF**, ON

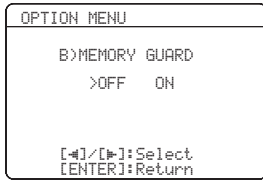

- Select “OFF” to turn off the “MEMORY GUARD” feature.
- Select “ON” to protect:
 - sound field program parameters
 - all “SET MENU” items
 - all speaker levels
 - SCENE template parameters

Note

When “MEMORY GUARD” is set to “ON”, you cannot select and adjust any other “SET MENU” items.

■ Audio select C>AUDIO SELECT

Use this feature to designate the default audio input jack select setting for the input sources when you turn on the power of this unit.

Choices: **AUTO**, LAST



- Select “AUTO” if you want this unit to automatically detect the type of input signals and select the appropriate audio input jack select setting.
- Select “LAST” if you want this unit to automatically select the last audio input jack select setting used for the connected input source.

■ Parameter initialization D>PARAM. INI

Use this feature to initialize the parameters of each sound field program within a sound field program group. When you initialize a sound field program group, all of the parameter values within that group revert to their initial factory settings.

Press the corresponding sound field program selector buttons on the remote control to select the sound field program that you want to initialize.

An asterisk (*) appears to the left of the sound field program names that have been changed from their initial factory settings.

Choices: **CLASSICAL**, **LIVE/CLUB**, **ENTERTAINMENT**, **MOVIE**, **STEREO**, **ENHANCER**, **SUR. DECODE**



Notes

- You cannot automatically revert to the previous parameter settings once you initialize a sound field program group.
- You cannot separately initialize individual sound field programs.
- You cannot initialize any sound field program groups when “MEMORY GUARD” is set to “ON”.

■ Zone 2 settings E>ZONE2 SET

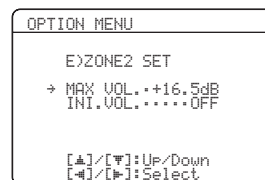

Zone 2 Maximum volume MAX VOL.

Use this feature to set the maximum volume level in the Zone 2.

Control range: **16.5 dB**, 15.0 dB to –30.0 dB

Control step: 5.0 dB

Notes

- The “MAX VOL.” setting takes priority over the “INI VOL.” setting. For example, when “INI VOL.” is set to –20.0 dB and then “MAX VOL.” is set to –30.0 dB, the volume level is automatically set to –30.0 dB when you turn on the power of this unit next time.
- The “MAX VOL.” setting does not affect the output level at the “ZONE 2 OUT” jacks.

Zone 2 Initial volume INI VOL.

Use this feature to set the volume level of Zone 2 when the power of this unit is turned on.

Choices: **Off**, -80.0 dB to +16.5 dB

Control step: 0.5 dB

Notes

- The “MAX VOL.” setting takes priority over the “INI VOL.” setting.
- When you select “FRONT B”, “PRNS” or “NONE” in “EXTRA SP ASSIGN” (see page 70), “Zone 2 SP Not Assigned” appears in the OSD and the “ZONE2 SET” parameter is not available.
- The “INI VOL.” setting does not affect the output level at the ZONE 2 OUT jacks.

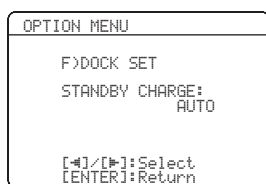
iPod universal dock setting F>DOCK SET**Charge on standby** STANDBY CHARGE

Use this feature to select whether this unit charges the battery of the stationed iPod or not when this unit is in the standby mode (see page 56).

Choices: **AUTO**, OFF

- Select “AUTO” to charge the battery of the stationed iPod when this unit is turned on and in the standby mode.
- Select “OFF” to charge the battery of the stationed iPod only when this unit is turned on.

Remote control features

In addition to controlling this unit, the remote control can also operate other audiovisual components made by Yamaha and other manufacturers. To control your TV or other components, you must set up the appropriate remote control code for each input source (see page 85).

Using the remote control for the SCENE feature

■ Controlling the input source components in the SCENE mode

You can operate both this unit and the input source component by using the remote control. You must set the appropriate remote control code for each input source in advance (see page 85).

- 1 Press the desired **(A) SCENE** button on the remote control.
- 2 Press the desired buttons in the * area below to control the input source component of the selected SCENE template.

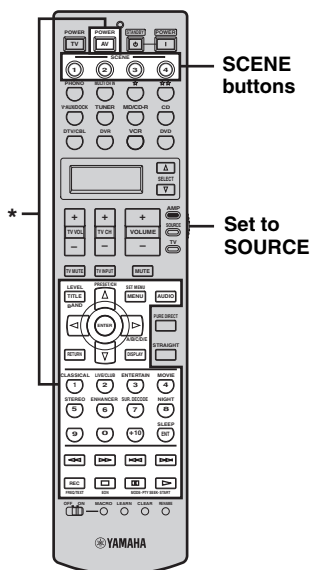

Note

* These buttons control the input source component. See page 84 for details of the function of each button.

■ Setting the input source of the customized SCENE template on the remote control

If you customize the input source of the selected SCENE template, you must set the input source of the SCENE template on the remote control to operate the input source component correctly.

- 1 Press and hold the **(A) SCENE** button and the desired input selector button **(A)**.
The transmit indicator **(X)** flashes twice.
- 2 Keep holding down the buttons pressed in step 2 until "OK" appears in the display window **(D)** on the remote control.

Note

If the setting of the input source is not successful, "NG" appears in the display window **(D)**. In this case, repeat the setting procedure.

Controlling this unit, a TV, or other components

Controlling this unit

Set the operation mode selector to **LAMP** to control this unit.

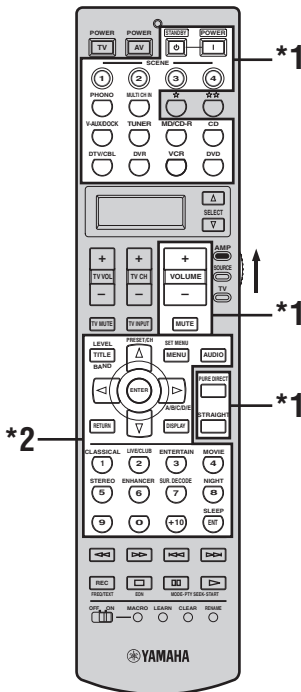

Notes

- *1 These buttons always control this unit regardless of the operation mode selector position.
- *2 These buttons control this unit only when the component operation mode selector is set to **LAMP**.

Controlling a TV

Set the operation mode selector to **LTV** to control your TV. To control your TV, you must set the appropriate remote control code for DTV/CBL or PHONO (see page 85). When you set the remote control codes for both DTV/CBL and PHONO, priority is given to the one set for DTV/CBL.

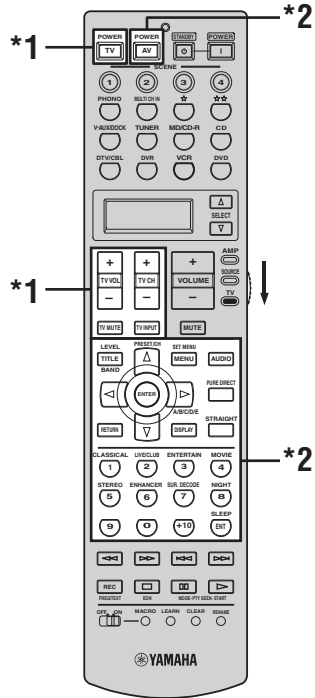

Notes

- *1 These buttons always control your TV regardless of the operation mode selector position.

Remote control	Digital TV/Cable TV
TV POWER	Turns on or off the power.
TV VOL +/-	Increases or decreases the volume level.
TV CH +/-	Changes the channel number.
TV MUTE	Mutes the audio output.
TV INPUT	Changes the input source.

- *2 These buttons control your TV only when the operation mode selector is set to **LTV**. For details, see the "TV" column on page 84.

■ Controlling other components

Set the operation mode selector to **LSOURCE** to control other components selected with the input selector buttons (B), ☆ or ☆☆. You must set the appropriate remote control code for each input source in advance (see page 85). The following table shows the function of each control button used to control other components assigned to each input selector button (B), ☆ or ☆☆. Be advised that some buttons may not correctly operate the selected component.

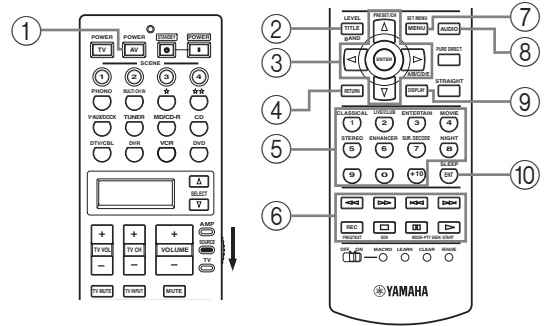

The remote control has 12 modes (input areas) to control components so that the remote control can operate up to 12 different components.

	DVD player/ DVD recorder	VCR	Cable TV/ Satellite tuner	TV	LD player	CD player	MD recorder/ CD recorder	Tape deck	Tuner	iPod
① AV POWER	Power *1	Power *1	Power *1	VCR power *2	Power *1	Power *1	Power *1	Power *1	Power *1	
② TITLE	Title	Title	Title	Title					Band	
③ ENTER	Menu enter		Menu select	Menu select						Subsequent menu
PRESET/CH Δ	Menu up		Menu up	Menu up					Preset up (1 to 8)	Up
PRESET/CH ∇	Menu down		Menu down	Menu down					Preset down (1 to 8)	Down
A/B/C/D/E ◀	Menu left		Menu left	Menu left					Preset down (A to E)	Previous menu
A/B/C/D/E ▶	Menu right		Menu right	Menu right				Direction A/B	Preset up (A to E)	Subsequent menu
④ RETURN	Return	Return	Return	Return						
⑤ 1-9, 0, +10	Numeric buttons	Numeric buttons	Numeric buttons	Numeric buttons	Numeric buttons	Numeric buttons	Numeric buttons			
⑥ ◀◀	Search backward	Search backward	DVR search backward *2	DVR search backward *2	Search backward	Search backward	Search backward	Search backward		Search backward *3
▶▶	Search forward	Search forward	DVR search forward *2	DVR search forward *2	Search forward	Search forward	Search forward	Search forward		Search forward *3
◀◀	Skip backward		DVR skip backward	DVR skip backward	Chapter/Skip backward	Skip backward	Skip backward	Direction back		Skip backward
▶▶	Skip forward		DVR skip forward	DVR skip forward	Chapter/Skip forward	Skip forward	Skip forward	Direction forward		Skip forward
REC/ DISC SKIP	Disc skip (player) Rec (recorder)	Rec	DVR rec *2	DVR rec *2		Disc skip	Rec	Rec		
□	Stop	Stop	DVR stop *2	DVR stop *2	Stop	Stop	Stop	Stop		Stop
⏸	Pause	Pause	DVR pause *2	DVR pause *2	Pause	Pause	Pause	Pause		Pause (Play/Pause) *4
▶	Play	Play	DVR play *2	DVR play *2	Play	Play	Play	Play		Play (Play/Pause) *4
⑦ MENU	Menu		Menu	Menu						Previous menu
⑧ AUDIO	Audio				Audio					
⑩ DISPLAY	Display		Display	Display	Display	Display	Display			Display
⑪ ENT		Enter	Enter/recall	Enter						

Notes

*1 This button is operational only when the original remote control supplied with the component has a POWER button.

*2 These buttons operate your VCR or DVR when you set the appropriate remote control code for DVR (see page 85).

*3 Press and hold to search backward or forward.

*4 Simple remote mode (see page 56).

■ Selecting a component to be controlled

You can select a component to be controlled independently of the input source selected with the input selector buttons.

Press **SELECT** Δ / ∇ repeatedly to select the desired component.

The name of the component to be controlled appears in the display window (D) on the remote control.



■ Controlling optional components (Option mode)

“OPTN” is an optional component control area that can be programmed with remote control functions independently from any input source. This area is useful for programming commands that are to be used only as a part of a macro function or for components that do not have a valid remote control code.

To select the option mode, press **SELECT** Δ / ∇ repeatedly until “OPTN” appears in the display window (D) on the remote control.



Note

You cannot set a remote control code for the optional area. See page 87 to program buttons operated within this component control area.

Setting remote control codes

You can control other components by setting the appropriate remote control codes. Codes can be set up for each input area. For a complete list of available remote control codes, refer to “List of remote control codes” at the end of this manual.

The following table shows the default component (Library: component category) and the remote control code for each input area.

Remote control code default settings

Input area	Library (component category)	Manufacturer	Default code
PHONO	TV	—	—
MULCH CH IN	DVD	YAMAHA	2100
☆	LD	YAMAHA	2200
☆☆	TAPE	YAMAHA	2700
V-AUX/DOCK	TUNER	YAMAHA	2606
TUNER	TUNER	YAMAHA	2602
MD/CD-R	CD-R	YAMAHA	2400
CD	CD	YAMAHA	2300
DTV/CBL	TV	—	—
DVR	DVR	YAMAHA	2807
VCR	VCR	—	—
DVD	DVD	YAMAHA	2100

Note

You may not be able to operate your Yamaha component even if a YAMAHA remote control code is preset as listed above. In this case, try setting another YAMAHA remote control code.

- 1 Set the operation mode selector to **SOURCE** and then press an input selector button (B), ☆ or ☆☆ to select the input area you want to set up.

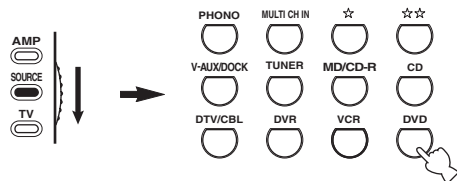

2 Press and hold **LEARN** for about 3 seconds using a ballpoint pen or similar object.

The library name (ex. L;DVD) and the name of the selected input area (ex. DVD) appear alternately in the display window (④) on the remote control.

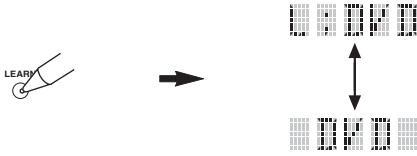

- You can set a remote control code of a different type of component to an input area. Press **◀/▶** repeatedly to change the library (component category).

Library choices: L;DVD, L;DVR, L;LD, L;CD, L;CDR, L;MD, L;TAP (tape), L;TUN (tuner), L;AMP, L;TV, L;CAB (cable), L;SAT (satellite), L;VCR

- If you want to setup for another input area, press the input selector button, ☆ or ☆☆, or press **SELECT Δ/∇** repeatedly to select the input area.

Notes

- Be sure to press and hold **LEARN** for at least 3 seconds, otherwise the learning process will start.
- If you do not complete each of the following steps within 30 seconds, the setting mode will be automatically canceled. In this case, start over from step 2.

3 Press **ENTER**.

The four-digit code set for the selected component appears in the display window (④).

Note

“0000” appears in the display window (④) if no code has been set.

4 Press the numeric buttons (②) to enter the four-digit remote control code for the component you want to use.

For a complete list of available remote control codes, refer to “List of remote control codes” at the end of this manual.

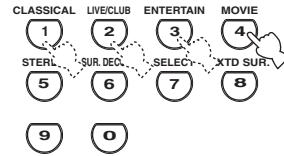

5 Press **ENTER** to set the number.

“OK” appears in the display window (④) on the remote control if setting was successful.

“NG” appears in the display window (④) on the remote control if the setting was unsuccessful. In this case, start over from step 3.



If you continuously want to set up another code for another component, press the input selector button (Ⓑ) or ☆, or **SELECT Δ/∇** repeatedly to select the component, then repeat steps 2 through 5.

6 Press **LEARN** again to exit from the setup mode.



7 Press **▶** or **AV POWER** to confirm whether you can control your component using the remote control.

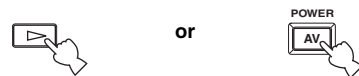

If operation is not possible and the manufacturer of your component has more than one code, try each of them until you find the correct one.

Notes

- “ERROR” appears in the display window (④) on the remote control if you press a button not indicated in the respective step, or when you press more than one button simultaneously.
- The supplied remote control does not contain all possible codes for commercially available audio and video components (including Yamaha components). If operation is not possible with any of the remote control codes, program the new remote control function using the learn feature (see “Programming codes from other remote controls” on page 87) or use the remote control supplied with the component.
- Functions programmed using the learn feature take priority over remote control code functions.

Programming codes from other remote controls

You can program remote control codes from other remote controls. Use the learn feature if you want to program functions not included in the basic operations covered by the remote control codes, or an appropriate remote control code is not available. You can program the function of other remote control to the buttons in the highlighted areas in the following illustration. The buttons can be programmed independently for each input area.

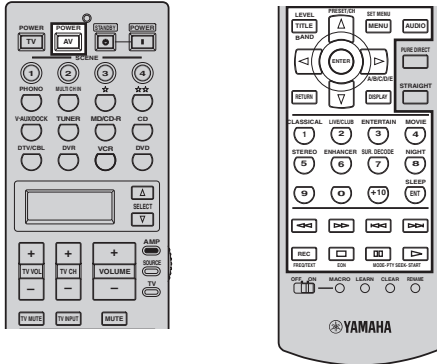

Note

The remote control transmits infrared rays. If the other remote control also uses infrared rays, this remote control can learn most of its functions. However, you may not be able to program some special signals or extremely long transmissions. Refer to the operating instructions for the other remote control.

- 1 Set the operation mode selector to **ⓁSOURCE** and then press an input selector button(Ⓑ), ☆ or ☆☆ to select an input area.

Note

Make sure that the operation mode selector is set to **ⓁSOURCE**. When you set the operation mode selector to **ⓁAMP** and program a remote control codes from other remote controls, the programmed key cannot operate the amplifier function of this unit.

- 2 Place this remote control about 5 to 10 cm (2 to 4 in) apart from the other remote control on a flat surface so that their infrared transmitters are aimed at each other.

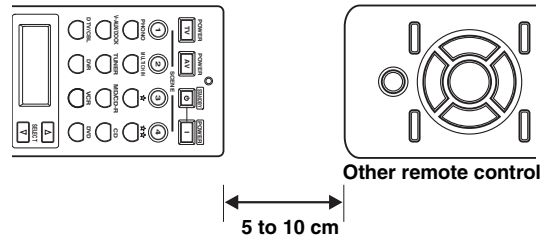

- 3 Press **ⓉLEARN** using a ballpoint pen or similar object.

“LEARN” and the name of the selected input area (ex. “DVD”) appear alternately in the display window (Ⓧ) on the remote control.

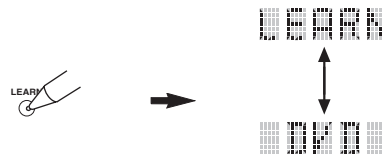

Notes

- Do not press and hold **ⓉLEARN**. If you hold it down for more than 3 seconds, the remote enters the remote control code setting mode.
- If you do not complete each of the following steps within 30 seconds, the learning mode will be automatically canceled. In this case, start over from step 3.

- 4 Press the button for which you want to program the new function.
“LEARN” appears in the display window (Ⓧ) on the remote control.



5 Press and hold the button you want to program on the other remote control until “OK” appears in the display window (J) on the remote control.

“NG” appears in the display window (J) on the remote control if learning was unsuccessful. In this case, start over from step 4.

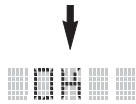
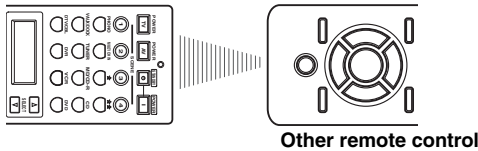

- If you want to program another function, repeat steps 4 and 5.
- If you continuously want to program another function for another component, press **SELECT** Δ / ∇ to select the component, and then repeat steps 4 and 5.

6 Press **LEARN again to exit the learning mode.**



Notes

- “ERROR” appears in the display window (J) on the remote control if you press a button not indicated in the respective step, or when you press more than one button simultaneously.
- This remote control can learn approximately 200 functions. However, depending on the signals learned, “FULL” may appear in the display before you program 200 functions. In this case, clear unnecessary programmed functions to make room for further learning.
- Learning may not be possible in the following cases:
 - when the batteries in the remote control for this unit or other components are weak.
 - when the distance between the two remote controls is too great or too small.
 - when the remote control infrared windows are not facing each other at the appropriate angle.
 - when the remote control is exposed to direct sunlight.
 - when the function to be programmed is continuous or uncommon.

Changing source names in the display window

You can change the name of the input source that appears in the display window (J) on the remote control if you want to use a different name than the factory preset. This feature is useful when you have set an input area to control a different component.

1 Set the operation mode selector to **AMP or **SOURCE** and then press an input selector button (B), \star or $\star\star$ to select the input area you want to rename.**

The name of the selected input area appears in the display window (J).

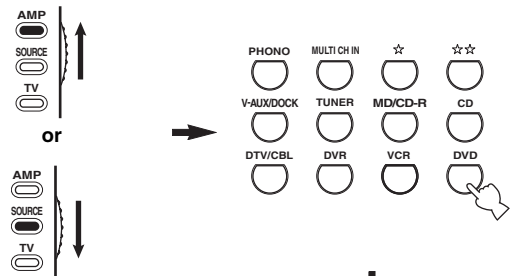

2 Press **RENAME using a ballpoint pen or similar object.**



Note

If you do not complete each of the following steps within 30 seconds, the renaming mode will be automatically canceled. In this case, start over from step 2.

3 Press $\odot\Delta/\nabla$ to select and enter a character.

Pressing $\odot\nabla$ changes the character as follows:
A to Z, 1 to 9, 0, + (plus), - (hyphen), ; (semicolon), / (slash), and space.

Pressing $\odot\Delta$ changes the characters in reverse order.

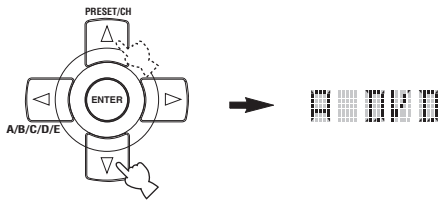

4 Press $\odot\triangleright$ to move the cursor to the next position.

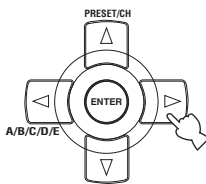

Press $\odot\triangleleft$ to move the cursor to the previous position.

5 Press \odot ENTER to set the new name.

“OK” appears in the display window (④) on the remote control if renaming was successful.

“NG” appears in the display window (④) on the remote control if renaming was unsuccessful. In this case, start over from step 3.



If you continuously want to rename another input area, press the input selector button (⑥), ☆, or ☆☆, or press \odot SELECT Δ/∇ repeatedly to select the component, then repeat steps 3 through 5.

6 Press RENAME again to exit the renaming mode.



Note

“ERROR” appears in the display window (④) on the remote control if you press a button not indicated in the respective step, or when you press more than one button simultaneously.



This feature is useful when you change the input or output assignment for digital jacks and component video input jacks. Refer to “Input rename” on page 77.

Macro programming features

The macro programming feature makes it possible to perform a series of operations with the press of a single button. For example, when you want to play a CD, normally you would turn on the components, select the CD input, and press the play button to start playback. The macro programming feature lets you perform all of these operations simply by pressing the CD macro button. The buttons listed as macro buttons below are factory set with macro programs. You can also program your own macros (see page 91).

MACRO operations

Macro buttons

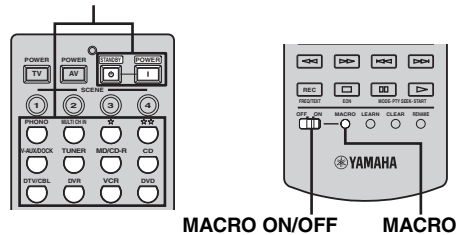

1 Set the \odot MACRO ON/OFF selector to ON.

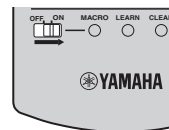

2 Press the desired macro button.

3 Set the \odot MACRO ON/OFF selector to OFF when you finish to using the macro programming operation.

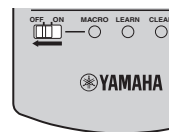

Notes

- While the remote control is running a macro program, it does not accept any other operation until it has completed running the program (the transmission indicator stops flashing).
- Continue to aim the remote control at the component the macro is operating until the macro operation is complete.

■ Default macro functions

Pressing macro button	To automatically transmit these signals in order		
	First	Second	Third
		—	—
	(*1)	(*2)	—
	(*1)		—
			—
			—
			—
			—
		(*3)	—
			(MD/CD-R area) (*4)
			(CD area) (*4)
			—
			(DVR area) (*4)
			(VCR area) (*4)
			(DVD area) (*4)

- *1 You can turn on some components (including Yamaha components) connected to this unit by connecting them to the AC OUTLETS on the rear panel of this unit. Power control may not be synchronized with this unit depending on the component. For details, refer to the operating instructions for the connected component.
- *2 When the remote control code for your TV is set up for either DTV/CBL or PHONO (see page 85), you can turn on the power of your TV without selecting an input source. The remote control code set up for DTV/CBL takes priority over the one for PHONO.
- *3 When TUNER is selected as the input source, this unit plays the last station received before the unit was set in the standby mode.
- *4 Playback can be started for any Yamaha remote control-compatible CD player, CD recorder, DVD player, or DVD recorder. When using macros to operate other components, you will need to program the play button on the input area of that component (see page 87) or set a remote control code (see page 85).

■ Programming macro operations

You can program your own macro and use the macro programming feature to transmit several remote control commands in sequence at the press of a button. Be sure to set up remote control codes or perform learning operations before programming the macro.

Notes

- The default macro is not cleared when a new macro is programmed for a button. The default macro can be used again when the programmed macro is cleared.
- It is not possible to add a new signal (macro step) to the default macro. Programming a macro changes all macro contents.
- We do not recommend programming continuous operations such as volume control in a macro.

1 Set the operation mode selector to **AMP** or **SOURCE** and then press **MACRO** using a ballpoint pen or similar object.

“MCR ?” appears in the display window (Ⓧ) on the remote control.

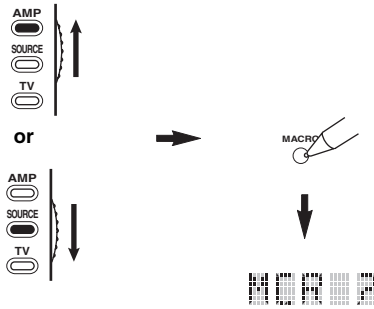

Note

If you do not complete each of the following steps within 30 seconds, the macro programming mode will be automatically canceled. In this case, start over from step 1.

2 Press the macro button you want to use to operate the macro.

The macro button name (ex. “M;DVD”) and the selected component name (ex. “DVD”) appear alternately in the display window (Ⓧ) on the remote control.

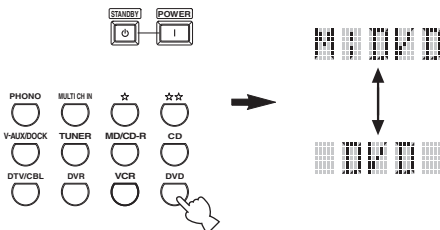

Note

“AGAIN” appears in the display window (Ⓧ) if you press a button other than a macro button.

3 Press the buttons for the functions you want to include in the macro operation in sequence.

You can set up to 10 steps (10 functions). After you have set 10 steps, “FULL” appears and the remote control automatically exits the macro mode. The following example is for programming the following procedure:

Step 1 (“MCR 1”): Press POWER.

Step 2 (“MCR 2”): Press DVD.

Step 3 (“MCR 3”): Press STRAIGHT.

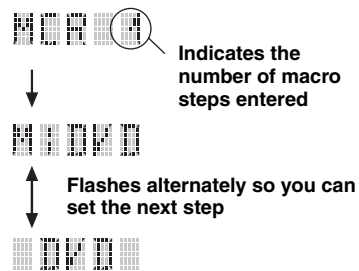
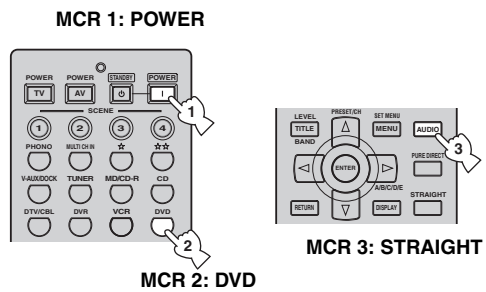

Note

To change the selected input area, press **SELECT** Δ / ∇ . Pressing the input selector buttons will program a macro step, whereas **SELECT** Δ / ∇ only changes the selected input area.

4 Press **MACRO** again using a ballpoint pen or similar object when the operation sequence you want to program is complete.

Note

“ERROR” appears in the display window (Ⓧ) if you press more than one button simultaneously.

Cleaning configurations

You can clear all changes made in each function set, such as learned functions, macros, renamed input area names and setup remote control ID.

■ Clearing function sets

1 Set the operation mode selector to **LAMP** or **SOURCE** and then press **CLEAR** by using a ballpoint pen or similar object.

“CLEAR” appears in the display window (D).

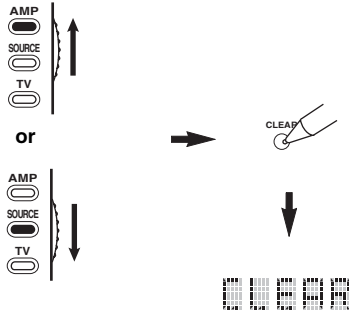

Note

If you do not complete each of the following steps within 30 seconds, the clearing mode will be automatically canceled. In this case, start over from step 1.

2 Press **⊙** / **△** / **▽** to select the clear mode.

L;CD (etc.)	(L; Name of an input area) Clears all learned functions in the respective input area. The name of a component is shown after a semicolon (;). Press an input selector button to select the input area.
L;AMP	Clears all learned functions for controlling the amplifier functions of this unit.
L;ALL	Clears all learned functions.
M;ALL	Clears all programmed macros.
RNAME	Clears all renamed source names.
FCTRY	Clears all remote functions and returns the remote to the factory settings.

3 Press and hold **⊙** CLEAR again for about 3 seconds.

“WAIT” appears in the display window (D). If clearing was successful, “C:OK” appears in the display window (D) on the remote control.



Once you have cleared a learned function for a button, the button reverts to the factory setting (or to the manufacturer setting, if you have set remote control codes).

Notes

- “L;ALL” and “FCTRY” may take about 30 seconds to complete.
- “C;NG” appears in the display window (D) if clearing was unsuccessful. In this case start over from step 2.
- “ERROR” appears in the display window (D) if you press a button not indicated in the respective step, or if you press more than one button simultaneously.

■ Clearing a learned function

You can clear the function learned for a certain button in each control area.

1 Set the operation mode selector to **AMP** or **SOURCE** and then press an input selector button (B), ☆ or ☆☆ to select the input area containing the function you want to clear.

The selected component name appears in the display window (D).

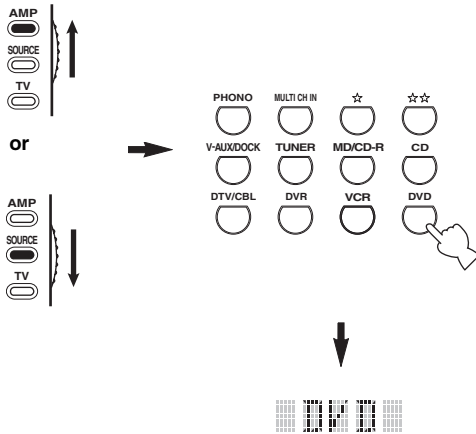

2 Press **CLEAR** using a ballpoint pen or similar object.

“LEARN” and the selected component name (ex. “DVD”) appear alternately in the display window (D).

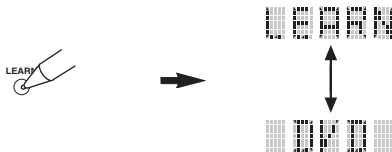

Notes

- Do not press and hold **LEARN**. If you hold it down for more than 3 seconds, the remote control enters the remote control code setting mode.
- If you do not complete each of the following steps within 30 seconds, the learning mode will be automatically canceled. In this case, start over from step 2.

3 Press and hold **CLEAR** using a ballpoint pen or similar object and then press the button you want to clear for about 3 seconds.

“C:OK” appears in the display window (D) if clearing was successful. Once “C:OK” appears in the display window (D) on the remote control, release the ballpoint pen or similar object used to press **CLEAR** to exit the clearing mode. The remote control returns to the learning mode.

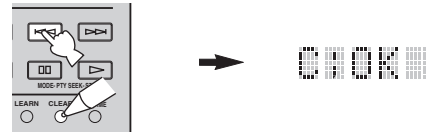

- If you continuously want to clear another function, repeat step 3.
- If you continuously want to clear another function for another component, press **SELECT** Δ / ∇ to select the input area, then repeat step 3.
- Once you clear a learned function, the button reverts to the factory setting (or to the manufacturer setting if you have set remote control codes).

4 Press **LEARN** again to exit.

Notes

- “C:NG” appears in the display window (D) on the remote control if clearing was unsuccessful. In this case, start over from step 2.
- “ERROR” appears in the display window (D) on the remote control if you press more than one button simultaneously.

■ Clearing a macro function

You can clear the function programmed for a certain macro button.

- 1 Set the operation mode selector to **AMP** or **SOURCE** and then press **MACRO** using a ballpoint pen or similar object.

“MCR ?” appears in the display window (D) on the remote control.

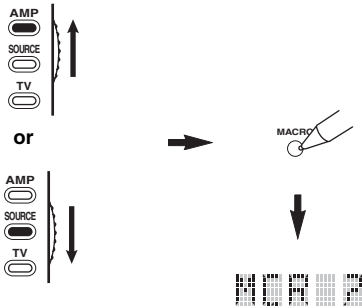

Note

If you do not complete each of the following steps within 30 seconds, the macro programming mode will be automatically canceled. In this case, start over from step 1.

- 2 Press and hold **CLEAR** using a ballpoint pen or similar object, then press the macro button you want to clear for about 3 seconds. “C;OK” appears in the display window (D) on the remote control if clearing was successful.

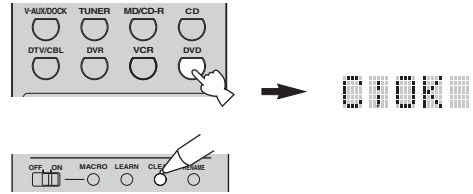

- If you continuously want to clear another function, repeat step 2.
- Once you clear a programmed function, the button reverts to the factory setting (or to the manufacturer setting if you have set remote control codes).

- 3 Press **MACRO** again to exit the macro programming mode.

Notes

- “C;NG” appears in the display window (D) on the remote control if clearing was unsuccessful. In this case, start over from step 2.
- “ERROR” appears in the display window (D) on the remote control if you press more than one button simultaneously.

Using multi-zone configuration

This unit allows you to configure a multi-zone audio system. The Zone 2 feature allows you to set this unit to reproduce separate input sources in the main zone and the second zone (Zone 2). You can control this unit from the second zone using the supplied remote control.

Only analog signals are sent to the second zone. Any source you want to listen to in the second zone must be connected to the analog AUDIO IN jacks of this unit.

Connecting Zone 2

You need the following additional equipment to use the multi-zone functions of this unit:

- An infrared signal receiver in the second zone.
- An infrared signal emitter in the main zone. This emitter transmits the infrared signals from the remote control via the infrared signal receiver in the second zone to a CD player or a DVD player, etc. in the main zone.
- An amplifier and speakers in the second zone.

- ☀️ Since there are many possible ways to connect and use this unit in a multi-zone configuration, we recommend that you consult with your nearest authorized Yamaha dealer or service center about the Zone 2 connections that best meet your requirements.
- Some Yamaha models are able to connect directly to the REMOTE jacks of this unit. If you own these products, you may not need to use an infrared signal emitter. Up to 6 Yamaha components can be connected as shown below.

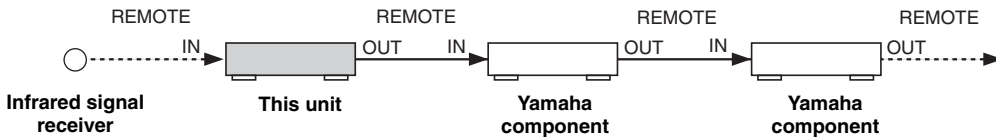

■ Using the external amplifier

Connect the amplifier/receiver in the second zone and other components to this unit as follows.

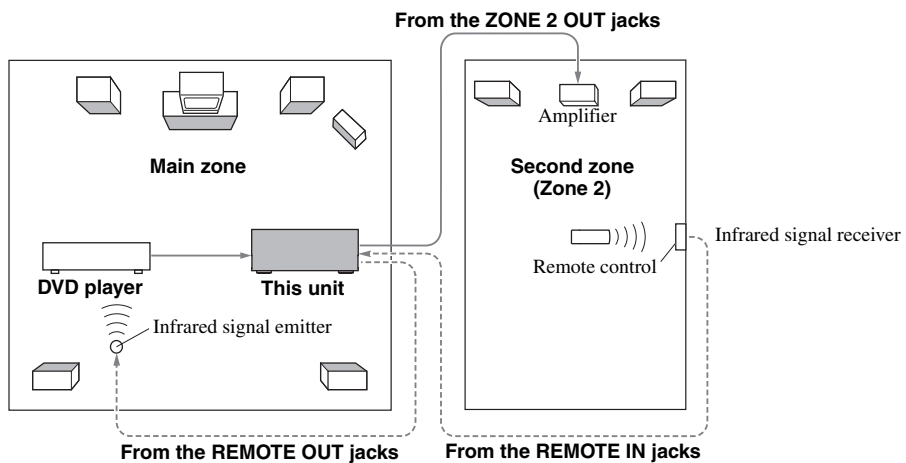

Note

To avoid unexpected noise, DO NOT USE the Zone 2 feature with CDs encoded in DTS.

■ Using the internal amplifier of this unit

Important safety notice

The EXTRA SP speaker terminals of this Receiver should not be connected to a Passive Loudspeaker Selector Box or more than one loudspeaker per channel.

Connection to a Passive Loudspeaker Selector Box or multiple speakers per channel could create an abnormally low impedance load resulting in amplifier damage. See this owner's manual for correct usage.

Compliance with minimum speaker impedance information for all channels must be maintained at all times. This information is found on the back panel of your Receiver.

Connect the speakers in the second zone to the EXTRA SP speaker terminals and then set the "EXTRA SP ASSIGN" to "ZONE2" (see page 70).

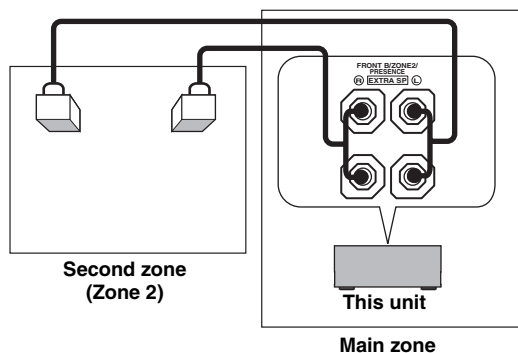

- You can use the FRONT B speakers as the front speaker system of another zone. Set "EXTRA SP ASSIGN" to "FRONT B" and then "FRONT B" to "ZONE B" (see page 70).
- When you use the internal amplifiers for the Zone 2 speakers, you can adjust the volume level and set the initial volume level and maximum volume level of the Zone 2 speakers (see page 80).

Controlling Zone 2

You can select and control Zone 2 by using the control buttons on the front panel or on the remote control. The available operations are as follows:

- Selecting the input source of Zone 2
- Tuning into FM or AM when "TUNER" is selected as the input source of Zone 2 (see page 50)
- Enjoying music stored on your iPod stationed in a Yamaha iPod universal dock (such as YDS-10 sold separately) connected to the DOCK terminal of this unit when "V-AUX" is selected as the input source (see page 56)

Note

You must complete each step while the ZONE2 indicator is flashing in the front panel display. Otherwise, the Zone 2 mode is automatically canceled and this unit returns to the normal operation mode. In this case, repeat the Zone 2 selection procedure.

■ Controlling Zone 2 with the front panel

Turning on Zone 2

Press **Ⓢ ZONE 2 ON/OFF** to turn on Zone 2.



Ⓢ ZONE 2 ON/OFF is operational only when **Ⓜ MASTER ON/OFF** on the front panel is pressed inward to the ON position. Once **Ⓜ MASTER ON/OFF** on the front panel is pressed inward to the ON position, you can also press **Ⓟ POWER** or **Ⓜ STANDBY** on the remote control to turn on the main zone and Zone 2 or set them to the standby mode.

Activating the Zone 2 operation mode

Press **Ⓢ ZONE CONTROL** to control Zone 2.

The ZONE2 indicator flashes in the front panel display for approximately 10 seconds.

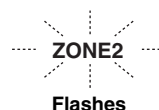

Operate the following operations after activating the Zone 2 operation mode.

Operating Zone 2

Rotate the **Ⓘ INPUT** selector to select the desired input source while the **ZONE2** indicator is flashing in the front panel display.

- Select “TUNER” as the input source to use the TUNER features in Zone 2. For details about the TUNER operations, see “FM/AM tuning” on page 50.
- Select “V-AUX” as the input source to use iPod features in Zone 2. For details about the iPod operations, see “Using iPod™” on page 56.



You must complete this step within 10 seconds while the selected zone flashes in the front panel display. Otherwise, the currently selected zone mode is automatically canceled. In this case, press **Ⓣ ZONE CONTROL** on the front panel again.

Set Zone 2 to the standby mode

Press **Ⓢ ZONE 2 ON/OFF** to set Zone 2 to the standby mode.

■ Controlling Zone 2 with the remote control

Activating the Zone 2 operation mode

Set the operation mode selector to **Ⓖ AMP** and then press **Ⓝ SELECT** **⬆** repeatedly to select the zone you want to control.

“ZONE 2” is displayed in the display window (Ⓝ) on the remote control.

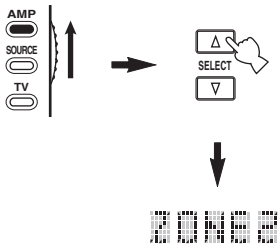

Turning on or off Zone 2 using the remote control

Ⓟ POWER and **Ⓢ STANDBY** on the remote control work differently depending on the selected zone that appears in the display window (Ⓝ) on the remote control.

- When the main zone, Zone 2 mode is selected, you can turn on the main zone or Zone 2 or set them to the standby mode individually.
- When the all mode is selected, pressing **Ⓟ POWER** turns on the main zone and Zone 2 simultaneously and pressing **Ⓢ STANDBY** sets them to the standby mode simultaneously.

Control mode	Display window (Ⓝ)	POWER and STANDBY
Main zone mode	Name of the selected input area	Turns on the main zone only or sets it to the standby mode.
Zone 2 mode	“ZONE 2” or “2;name of the selected input area”	Turns on Zone 2 or sets it to the standby mode.
All mode	“ALL”	Ⓟ POWER: turns on the main zone and Zone 2. Ⓢ STANDBY: sets the main zone and Zone 2 to the standby mode.

Notes

- When the remote control is in the main zone mode, “MAIN” appears for a few seconds when **Ⓟ POWER** or **Ⓢ STANDBY** is pressed.
- “ALL” appears in the display window (Ⓝ) on the remote control only when **SELECT** **⬇** is pressed.

Selecting the input source of Zone 2

Press one of the input selector buttons (**Ⓟ**) to select the input source of the selected zone.

If the remote control is used to select the input source, “2; name of the selected input area” is displayed in the display window (Ⓝ) on the remote control when Zone 2 is selected respectively.

Note

The selected input source is shared across all zones.

Advanced setup

This unit has additional menus that are displayed in the front panel display. The advanced setup menu offers additional operations to adjust and customize the way this unit operates. Change the initial settings (indicated in bold under each parameter) to reflect the needs of your listening environment.

Notes

- The settings you make are reflected next time you press **12** **MASTER ON/OFF** inward to the ON position to turn on this unit (see page 25).
- Only **12** **MASTER ON/OFF**, **13** **TONE CONTROL** and the **14** **PROGRAM** selector are effective while you are using the advanced setup menu.
- No other operations can be made while you are using the advanced setup menu.
- The advanced setup menu is only available in the front panel display.

Using the advanced setup

1 Press **12** **MASTER ON/OFF** on the front panel to release it outward to the OFF position to turn off this unit.

2 Press and hold **13** **TONE CONTROL** and then press **12** **MASTER ON/OFF** inward to the ON position to turn on this unit.

This unit turns on, and the advanced setup menu appears in the front panel display.



4 Press **13** **TONE CONTROL** repeatedly to change the selected parameter setting.

5 Press **12** **MASTER ON/OFF** to release it outward to the OFF position to save the new setting and turn off this unit.



The settings you made are reflected next time you turn on this unit.

3 Rotate the **14** **PROGRAM** selector to select the parameter you want to adjust.

The name of the selected parameter appears in the front panel display.

See page 99 for a complete list of available parameters.



See page 98 for the operation of the advanced setup.

■ Speaker impedance SP IMP.

Use this feature to set the speaker impedance of this unit so that it matches that of your speakers.

Choices: **8Ω MIN**, **6Ω MIN**

- Select “8Ω MIN” to set the speaker impedance to 8 Ω .
- Select “6Ω MIN” to set the speaker impedance to 6 Ω .

SP IMP.	Speaker	Impedance level
8Ω MIN	Front	If you use one set (A or B), the impedance of each speaker must be 8 Ω or higher. <hr/> If you use two sets (A and B), the impedance of each speaker must be 16 Ω or higher.*
	Center	The impedance of each speaker must be 8 Ω or higher.
	Surround	
	Surround back	
6Ω MIN	Front	If you use one set (A or B), the impedance of each speaker must be 4 Ω or higher. <hr/> If you use two sets (A and B), the impedance of each speaker must be 8 Ω or higher.
	Center	The impedance of each speaker must be 6 Ω or higher.
	Surround	
	Surround back	

* The Canada model cannot use two separate speaker systems (A and B) simultaneously when “SP IMP.” is set to “8Ω MIN”.

■ User presets PRESET

Use this feature to reset all the parameters of this unit to the initial factory settings (see page 109).

Choices: **CANCEL**, **RESET**

- Select “CANCEL” not to reset any parameters of this unit.
- Select “RESET” to reset the parameters of this unit.

Notes

- This setting completely resets all the parameters of this unit including the “SET MENU” parameters.
- The initial factory settings are activated next time you turn on this unit.

■ Remote control AMP ID REMOTE AMP

Use this feature to set the AMP ID of this unit for remote control recognition. This feature is useful when you operate this unit and the other Yamaha receivers/ amplifiers in the same room separately.

Choices: **ID1**, **ID2**

- Select “ID1” when the remote control AMP ID code is set to “2001”.
- Select “ID2” when the remote control AMP ID code is set to “2002”.

Setting remote control AMP ID codes

You need to set the remote control AMP ID code for the remote control.

1 Set the operation mode selector to **AMP or **SOURCE**.**

2 Press and hold **LEARN for about 3 seconds using a ballpoint pen or similar object and then press **ENTER** repeatedly until “L;AMP” appears in the display window (D) on the remote control.**

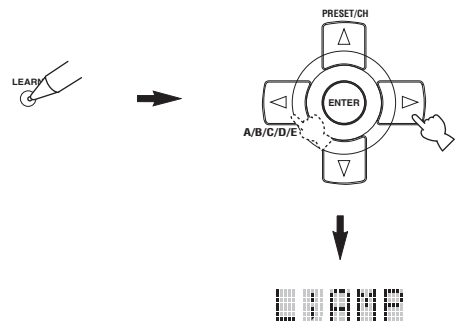

Notes

- Be sure to press and hold **LEARN** for at least 3 seconds, otherwise the learning process will start.
- If you do not complete each of the following steps within 30 seconds, the setting mode will be automatically canceled. In this case, start over from step 1.

3 Press **ENTER.**

The four-digit code set for the selected input area appears in the display window (D) on the remote control.

■ Remote control/Boîtier de télécommande/Fernbedienung/Fjärrkontrollen
Afstandsbediening/Пульт ДУ

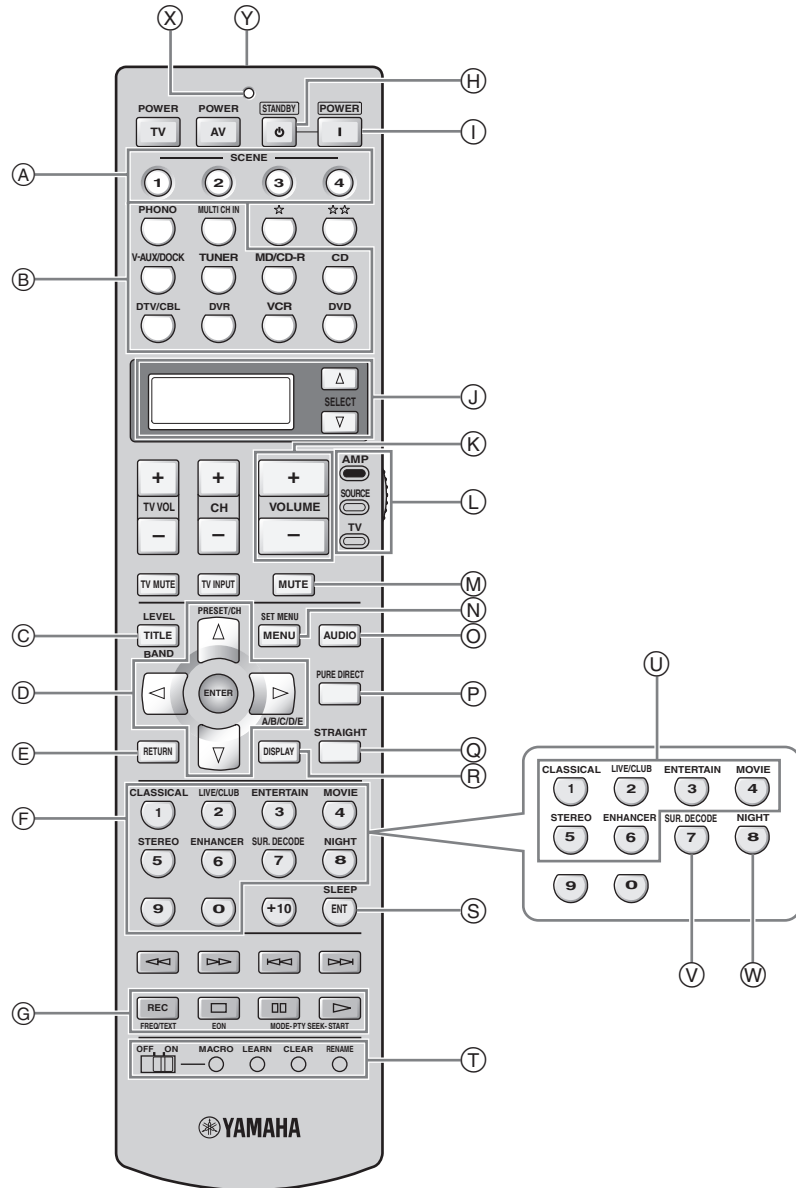

**List of remote control codes
Liste des codes de commande
Liste der Fernbedienungscodes
Lista över fjärrstyrningskoder
Lijst met afstandsbedieningscodes
Список кодов дистанционного управления**

CABLE		CD PLAYER		SAE	0184	HITEKER	0699
ABC	0030, 0035	AIWA	0184	SANSUI	0184, 0332	JVC	0585, 0650
AMERICAST	0926	ARCAM	0184	SANYO	0206	KLH	0744
BELL SOUTH	0926	AUDIO RESEARCH	0184	SCOTT	0332	KENWOOD	0517, 0561
BIRMINGHAM CABLE		AUDIO TON	0184	SEARS	0332	KOSS	0678
COMMUNICATIONS		AUDIOLAB	0184	SHARP	0064	LG	0768
	0303	AUDIOMECA	0184	SIMAUDIO	0184	LIMIT	0795
BRITISH TELECOM		CAIRN	0184	SONIC FRONTIERS	0184	MAGNAVOX	0530, 0702
	0030	CALIFORNIA AUDIO LABS	0056	SONY	0027	MARANTZ	0566
CABLE & WIRELESS		CARVER	0184, 0206	SYMPHONIC	0332	MEMOREX	0858
	1095	CYRUS	0184	TAG MCLAREN		MICO	0750
DAERYUNG	0035, 0504, 0904,	DKK	0027		0184	MICROSOFT	0549
	1904	DMX ELECTRONICS	0184	TANDY	0059	MINTEK	0744
DIRECTOR	0503		0184	TECHNICS	0056	MITSUBISHI	0548
FILMNET	0470	DENON	0900	THORENS	0184	MUSTEK	0757
GENERAL INSTRUMENT		DYNAMIC BASS	0206	THULE	0184	NESA	0744
	0030, 0303, 0503,	EMERSON	0332	UNIVERSUM	0184	ONKYO	0530
	0837,	FISHER	0206	VICTOR	0099	ORITRON	0678
GOLDSTAR	0171	GENEXXA	0059, 0332	WARDS	0184	PALSONIC	0699
HAMLIN	0036, 0300	GOODMANS	0332	YAMAHA	2300, 2301	PANASONIC	0517, 0659, 1389
JERROLD	0030, 0303, 0503,	GRUNDIG	0184			PHILIPS	0530, 0566, 0673,
	0837,	HARMAN/KARDON	0184, 0200				0881
LG	0171	HITACHI	0059	CD RECORDER		PIONEER	0552, 0598, 0658,
MNET	0470	JVC	0099	KENWOOD	0653		0659
MEMOREX	0027	KENWOOD	0055, 0064	MARANTZ	0653	POLK AUDIO	0566
MOTOROLA	0303, 0503, 0837,	KRELL	0184	PHILIPS	0653	PROSCAN	0549
	1133	LXI	0332	YAMAHA	2400	QWESTAR	0678
NTL	1095	LINN	0184			RCA	0549, 0598, 0744
NOOS	0844	MCS	0056			ROTEL	0650
ONO	1095	MAGNAVOX	0184, 0332	DVD PLAYER		SM ELECTRONIC	
PVP STEREO VISUAL MATRIX		MARANTZ	0056, 0184	ACOUSTIC SOLUTIONS			0757
	0030	MATSUI	0184	ALBA	0744	SAMSUNG	0600
PACE	0264, 1087, 1095	MEMOREX	0332	AMSTRAD	0740	SANYO	0697
PANASONIC	0027, 0035, 0134	MERIDIAN	0184	APEX DIGITAL		SHARP	0657
PARAGON	0027	MICROMEGA	0184		0699, 0744, 0782,	SHERWOOD	0797
PHILIPS	0332, 0344	MIRO	0027		0821, 0823, 0857,	SHINSONIC	0560
PIONEER	0171, 0560, 0904,	MISSION	0184		1127	SLIM ART	0811
	1904	MYRYAD	0184	BLAUPINKT	0744	SONY	0560, 0891
PULSAR	0027	NAD	0027	BLUE PARADE		SYLVANIA	0702
QUASAR	0027	NSM	0184		0598	TATUNG	0797
REGAL	0300, 0306	NAIM	0184	BUSH	0740	TEAC	0598, 0744
RUNCO	0027	OPTIMUS	0027, 0059, 0064,	CENTREX	0699	TECHNICS	0517
SAGEM	0844		0206, 0332	CLATRONIC	0815	THETA DIGITAL	
SAMSUNG	0027, 0171	PANASONIC	0056	CYBERHOME			0598
SCIENTIFIC ATLANTA		PHILIPS	0184		0741	THOMSON	0549
	0035, 0504, 0904,	PIONEER	0059, 0332	DVD2000	0548	TOSHIBA	0530
	1904	POLK AUDIO	0184	DAEWOO	0811, 0797	URBAN CONCEPTS	0530
SONY	1033	PROTON	0184	DANSAI	0797	XBOX	0549
STARCOM	0030	QED	0184	DECCA	0797	YAMAHA	0517, 0566, 0572,
SUPERCABLE		QUAD	0184	DENON	0517		2100
	0303	QUASAR	0056	DIAMOND	0795	ZENITH	0530, 0618, 0768
TS	0030	RCA	0059, 0206, 0332	DIGITREX	0699	ZEUS	0811
TELE+1	0470	REALISTIC	0206	EMERSON	0618		
TELEWEST	1095	REVOX	0184	ENTERPRISE	0618	DVD RECORDER	
TORX	0030	ROTEL	0184	FISHER	0697	HITACHI	2815
TOSHIBA	0027			GE	0549, 0744	PANASONIC	2800
TRANS PX	0303			GO VIDEO	0742	PHILIPS	2808
UNITED CABLE				GOLDSTAR	0768	PIONEER	2804
	0030			GRADIENTE	0678	TOSHIBA	2803
ZENITH	0027, 0552, 0926			GREENHILL	0744	YAMAHA	2807
				GRUNDIG	0566		
				HITACHI	0600, 0691		

LD PLAYER

CARVER	0091
DENON	0086
MARANTZ	0091
mitsubishi	0086
NAD	0086
NAGSMI	0086
OPTIMUS	0086
PHILIPS	0091
PIONEER	0086
SALORA	0091
SONY	0228
TELEFUNKEN	0086
YAMAHA	2200

MD RECORDER

KENWOOD	0708
ONKYO	0895
SHARP	0888
SONY	0517
YAMAHA	2500, 2501, 2502

RECEIVER (TUNER)

ADC	0558
AIWA	0185, 1116, 1415, 1432, 1668
ALCO	1417
ANAM	1636
APEX DIGITAL	1284
AUDIOLAB	1216
AUDIOTRONIC	1216
AUDIOVOX	1417
BOSE	1256
CAMBRIDGE SOUNDWORKS	1397
CAPETRONIC	0558
CARVER	1116, 1216
CENTREX	1284
DENON	1387
FERGUSON	0558
FINE ARTS	1216
GRUNDIG	1216
HARMAN/KARDON	0137, 1331
INTEGRA	0162, 1325
JBL	0137, 1333
JVC	0101, 0558, 1401, 1522
KLH	1417, 1439
KENWOOD	1054, 1340
MCS	0066
MAGNAVOX	0558, 1116, 1216, 1296,
MARANTZ	0066, 1116, 1216, 1316
MICROMEGA	1216
MUSICMAGIC	1116
MYRYAD	1216
NAD	0347
NORCENT	1416
ONKYO	0162, 0869, 1325
OPTIMUS	0558, 1050
PANASONIC	0066, 1315, 1545, 1790

PHILIPS	1116, 1216, 1293, 1295, 1296, 1310, 1316
PIONEER	0041, 0558, 1050, 1411
POLK AUDIO	1316
PROSCAN	1281
QUASAR	0066
RCA	0558, 1050, 1281, 1417, 1636,
SABA	0558
SANSUI	1116
SCHNEIDER	0558
SONY	0185, 1085, 1185, 1685, 1785
STEREOPHONICS	1050
SUNFIRE	1340
TEAC	1417
TECHNICS	0066, 1335, 1336, 1545
TELEFUNKEN	0558
THOMSON	1281
THORENS	1216
UHER	0558
VENTURER	1417
VICTOR	0101
WARDS	0041, 0185
YAMAHA	0203, 1203, 1358, 2601
(TUNER ID1)	2602
(TUNER ID2)	2603
(iPod)	2606

SATELLITE TUNER

@SAT	1327
ABSAT	0150
ALBA	0482
ALPHASTAR	0799
AMSTRAD	0874
ASTON	0169, 1156
ASTRO	0200
ATSAT	1327
AVALON	0423
BLAUPUNKT	0200
BRITISH SKY BROADCASTING	0874, 1202
CANAL DIGITAL	0880
CANAL SATELLITE	0880
CANAL+	0880
CHAPARRAL	0243
CITYCOM	1203
CONNEXIONS	0423
CROSSDIGITAL	1136
CYRUS	0227
D-BOX	0750, 1154
DMT	1102
DNT	0227, 0423
DAERYUNG	0423
DAEWOO	1323
DIGENIUS	0326
DIRECTV	0274, 0419, 0593, 0666, 0751, 0776, 0846, 1103, 1136, 1169, 1776, 1883
DISH NETWORK SYSTEM	0802, 1032

DISHPRO	0802, 1032
DISTRATEL	0111
DREAM MULTIMEDIA	1264
ECHOSTAR	0194, 0423, 0637, 0802, 0880, 0898, 1032, 1113
ENGEL	1044
EXPRESSVU	0802
FTE	0890
FINLUX	0482
FRACARRO	0898
FUBA	0423
GE	0593
GOI	0802
GALAXIS	0890, 1138
GENERAL INSTRUMENT	0896
GOLD BOX	0880
GRUNDIG	0200, 0874
HTS	0802
HIRSCHMANN	0200, 0423
HITACHI	0482, 0846
HUGHES NETWORK SYSTEM	0776, 1169, 1776
HUMAX	0890, 1203
INVIDEO	0898
JVC	0802
KATHREIN	0150, 0200, 0227, 0276, 0685, 1248
KREISELMEYER	0200
LABGEAR	1323
LOGIX	1044
LORENZEN	0326
MAGNAVOX	0749, 0751
MANHATTAN	0482, 1044, 1110
MARANTZ	0227
MEDIASAT	0880
MEMOREX	0751
METRONIC	0111
MITSUBISHI	0776
MOTOROLA	0896
MYRYAD	0227
NEXT LEVEL	0896
NOKIA	0482, 0750, 0778, 1154, 1250, 1750
OCTALTV	1032
ORBITECH	1127
PACE	0482, 0874, 1202, 1350
PANASONIC	0274, 0728, 0874, 1347
PANDA	0482
PAYSAT	0751
PHILIPS	0160, 0227, 0482, 0749, 0751, 0776, 0880, 1103, 1169, 1776
PIONEER	0880
PROMAX	0482
PROSCAN	0419, 0593
RCA	0170, 0419, 0593, 0882
RFT	0227
RADIO SHACK	0896
RADIOLA	0227
RADIX	0423
SKY	0874, 0883, 1202

SM ELECTRONIC	1227
SABRE	0482
SAGEM	0847, 1141, 1280
SAMSUNG	1044, 1136, 1303, 1319
SAT CONTROL	1327
SATSTATION	1110
SCHWAIGER	1138
SEEMANN	0423
SIEMENS	0200
SONY	0666, 0874, 1666
STAR CHOICE	0896
STRONG	1327
TPS	0847, 1280
TANTEC	0482
TECHNISAT	1126, 1127
TELESTAR	1127
THOMSON	0482, 0880, 1073, 1318
TOPFIELD	1233
TOSHIBA	0776, 0817, 1776
ULTIMATETV	0419, 0666
UNIDEN	0749, 0751
UNIVERSUM	0200
VENTANA	0227
WISI	0200, 0423, 0482
XSAT	0150
ZEHNDER	1102
ZENITH	0883, 1883

TAPE DECK

AIWA	0056
CARVER	0056
GRUNDIG	0056
HARMAN/KARDON	0056
MAGNAVOX	0056
MARANTZ	0056
MYRYAD	0056
OPTIMUS	0054
PHILIPS	0056
PIONEER	0054
POLK AUDIO	0056
RCA	0054
REVOX	0056
SANSUI	0056
SONY	0270
THORENS	0056
WARDS	0054
YAMAHA	2700, 2701

TV

AGB	0543
AOC	0036, 0057, 0087, 0119, 0120, 0135, 0205, 0207, 0478
ASA	0131
AWA	0036
ACURA	0036
ADDISON	0119, 0135, 0680
ADMIRAL	0120, 0190, 0490
ADVENT	0788
AIKO	0119
AKAI	0036, 0057, 0235, 0388, 0543, 0729, 0839
AKURA	0291
ALBA	0036, 0064, 0398, 0695

AMERICA ACTION	0207	DECCA	0064, 0543	HINARI	0036, 0064	MEDION	0695, 0835, 1064
AMPRO	0778	DENON	0172	HISAWA	0482	MEGATRON	0172, 0205
AMSTRAD	0036, 0064, 0198, 0398, 0439, 0460, 0543	DIGATRON	0064	HITACHI	0036, 0057, 0119, 0132, 0136, 0172, 0190, 0205, 0252, 0383, 0508, 0575, 0605, 1172, 1283	MEMOREX	0036, 0177, 0181, 0205, 0277, 0490, 1064
ANAM	0036, 0207, 0277	DUMONT	0044			METZ	0474
ANAM NATIONAL	0277, 0677	DWIN	0747, 0801	HUA TUN	0036	MICROMAXX	0835
ANITECH	0036	ECE	0064	HUANYU	0401	MICROSTAR	0835
APEX DIGITAL		ELECTROBAND	0027	HYPSON	0064, 0291	MIDLAND	0044, 0074, 0078
	0775, 0792, 0794	ELIN	0064, 0575	ICE	0291, 0398	MINERVA	0514
AUDIOSONIC	0064, 0136	ELITE	0347	ITS	0398	MINOKA	0439
BANG & OLUFSEN		ELTA	0036	ITT	0190, 0388, 0575	MITSUBISHI	0057, 0120, 0135, 0177, 0181, 0205, 0207, 0263, 0277, 0539, 0863, 1277
	0592	EMERSON	0181, 0205, 0207, 0263, 0388, 0490, 0650	IMPERIAL	0274, 0397, 0445	MIVAR	0318, 0319, 0543, 0636
BASIC	0036	ENVISION	0057, 0840	INDIANA	0064	MOTOROLA	0120
BAUR	0064, 0388, 0539	EPSON	0860	INFINITY	0081	MULTITECH	0036, 0207
BAYSONIC	0207	ERRES	0064	INGELEN	0190	MYRYAD	0583
BEAUMARK	0205	ETHER	0036, 0057	INNO HIT	0543	NAD	0183, 0205, 0388, 0893
BEKO	0397, 0513, 0741, 0742	ETRON	0036	INNOVA	0064	NEC	0036, 0057, 0078, 0181, 0183, 0197, 0205, 0482, 0524, 1731
BELL & HOWELL		EUROPHON	0543	INTEQ	0044	NEI	0064
	0181	FERGUSON	0064, 0100, 0136, 0265, 0314, 0362, 0587	INTERFUNK	0064, 0190, 0274, 0388, 0539	NTC	0119
BEON	0064			INTERVISION	0064, 0291, 0404	NECKERMANN	0064, 0583
BLAUPUNKT	0222	FIDELITY	0388	JBL	0081	NETSAT	0064
BLUE SKY	0695, 1064	FINLANDIA	0235, 0373	JCB	0027	NEWAVE	0036, 0119, 0120, 0205
BONDSTEC	0274	FINLUX	0064, 0131, 0132, 0373, 0543	JVC	0080, 0398, 0490, 0680, 0710	NIKKAI	0064, 0291
BRADFORD	0207	FIRSTAR	0036, 0263	JEAN	0036, 0078, 0119, 0183, 0263	NIKKO	0057, 0119, 0205
BRANDT	0136, 0362	FIRSTLINE	0036, 0274, 0695	JENSEN	0788	NOKIA	0388, 0500, 0507, 0575, 0658
BROKSONIC	0263, 0490	FISHER	0131, 0181, 0235, 0397	KEC	0207	NORCENT	0775, 0851
BUSH	0036, 0064, 0398, 0401, 0695, 1064	FLINT	0482	KTV	0057, 0207	NORDMENDE	0136, 0314, 0587
CCE	0064	FORMENTI	0064, 0347	KAISUI	0036	OCEANIC	0190, 0388
CGE	0274	FORTRESS	0120	KAPSCH	0190	ONWA	0207, 0460
CTC	0274	FRONTTECH	0190, 0274, 0291	KARCHER	0637	OPTIMUS	0181, 0193, 0277, 0677
CXC	0207	FUJITSU	0710, 0836	KATHREIN	0583	OPTONICA	0120
CANDLE	0057	FUNAI	0207, 0198, 0291	KENDO	0064	ORION	0064, 0263, 0347, 0490, 0543
CARNIVALE	0057	FUTURETECH	0207	KENWOOD	0057	OSAKI	0291, 0439
CARVER	0081, 0197	GE	0057, 0074, 0078, 0119, 0205, 0207, 0478, 0587, 1174, 1374, 1481	KNEISSEL	0286, 0462	OTTO VERSAND	0064, 0347, 0539, 0583
CASCADE	0036	GEC	0064, 0543	KOLIN	0080, 0135, 0207	PALLADIUM	0397, 0445
CATHAY	0064	GATEWAY	1782, 1783	KORPEL	0064	PANAMA	0291
CELEBRITY	0027	GELOSO	0036	KOYODA	0036	PANASONIC	0064, 0078, 0081, 0190, 0277, 0677, 1437
CELERA	0792	GENEXXA	0190	L&S ELECTRONIC	0835	PATHE CINEMA	0265, 0347
CENTURION	0064	GIBRALTER	0044, 0057	LG	0057, 0064, 0087, 0135, 0205, 0741	PAUSA	0036
CHANGHONG	0792	GOLDSTAR	0057, 0064, 0136, 0181, 0205, 0404	LXI	0074, 0081, 0181, 0183, 0205	PENNEY	0057, 0074, 0078, 0087, 0183, 0205, 1374
CHING TAI	0036, 0119	GOODMANS	0064, 0398, 0401, 0661	LEYCO	0064, 0291	PERDIO	0347
CHUN YUN	0027, 0036, 0119, 0207	GOREMJE	0397	LIESENK & TTER	0064	PHILCO	0057, 0064, 0081, 0172, 0205, 0207, 0274, 0490, 1688
CHUNG HSIN	0080, 0135, 0207	GRADIENTE	0080, 0197	LOEWE	0539	PHILIPS	0027, 0057, 0064, 0078, 0081, 0119, 0135, 0205, 0401, 0583, 0717, 1481
CIMLINE	0036	GRAETZ	0190, 0388	LUXOR	0383, 0388	PHONOLA	0064
CINERAL	0119, 0478	GRANADA	0064, 0235, 0366, 0543	M ELECTRONIC	0036, 0064, 0131, 0132, 0136, 0190, 0314, 0373, 0401, 0507	PILOT	0057
CITIZEN	0057, 0087, 0119	GRANDIN	0637	MAGNADYNE	0274, 0543		
CLARION	0207	GRUNDIG	0064, 0222, 0514, 0583, 0614	MAGNAFON	0543		
CLARIVOX	0064	GRUNPY	0207	MAGNAVOX	0057, 0081, 1281, 1481		
CLATRONIC	0274, 0397	HCM	0036, 0439	MANESTH	0291, 0347		
CONDOR	0347, 0397	HALLMARK	0205	MARANTZ	0057, 0064, 0081, 0583		
CONRAC	0835	HANKOOK	0057, 0205, 0207	MARK	0064		
CONTEC	0036, 0207	HANSEATIC	0064, 0347, 0388, 0455, 0583	MATSUI	0036, 0064, 0235, 0398, 0514, 0543		
CRAIG	0207	HANTAREX	0543	MATSUSHITA	0277, 0677		
CROSLEY	0081	HARMAN/KARDON	0081	MEDIATOR	0064		
CROWN	0036, 0064, 0207, 0397, 0445	HARVARD	0207				
CURTIS MATHES		HAVERMY	0120				
	057, 0074, 0081, 0087, 0120, 0172, 0181, 0193, 0478, 0729, 1174, 1374	HELLO KITTY	0478				
DAEWOO	0036, 0057, 0064, 0119, 0135, 0181, 0197, 0205, 0207, 0401, 0478, 0650, 0661, 1688						
DANSAI	0064						
DAYTON	0036						
DE GRAAF	0235, 0575						

PIONEER	0136, 0190, 0193, 0314, 0706, 0787, 0893	SEMIVOX	0207	TRIUMPH	0543	CANON	0062
PORTLAND	0119	SEMP	0183	TUNTEX	0036, 0057, 0119	CARVER	0108
PRANDONI-PRINCE	0543	SHARP	0057, 0120, 0677	UHER	0347	CIMLINE	0099
PRIMA	0788	SHEN YING	0036, 0119	UNIVERSUM	0064, 0131, 0132, 0291, 0373, 0397, 0519	CINERAL	0305
PRISM	0078	SHENG CHIA	0036, 0120, 0263	VECTOR RESEARCH	0057	CITIZEN	0064, 0305, 1305
PROFEX	0036, 0388	SIAREM	0543	VESTEL	0064	COLT	0099
PROSCAN	0074	SIEMENS	0064, 0222	VICTOR	0080, 0277, 0677, 0680	COMBITECH	0379
PROTECH	0036, 0064, 0274, 0291, 0445, 0695	SINUDYNE	0543	VIDEOSAT	0274	CRAIG	0064, 0074, 0099, 0267
PROTON	0036, 0057, 0205	SKANTIC	0383	VIDIKRON	0081	CROWN	0099, 0305
PULSAR	0044	SKYGIANT	0207	VIDTECH	0205	CURTIS MATHES	0062, 0068, 0087, 1062
QUASAR	0078, 0277, 0677	SKYWORTH	0064	VIEWSONIC	1782	CYBERNEX	0267
QUELLE	0064, 0131, 0388, 0539	SOLAVOX	0190	VISION	0347	CYRUS	0108
R-LINE	0064	SONITRON	0235	VOXSON	0190	DAEWOO	0072, 0131, 0305, 0669, 1305
RCA	0027, 0057, 0074, 0117, 0119, 0205, 0706, 1074, 1174, 1274, 1374, 1474, 1481, 1574	SONOKO	0036, 0064	WALTHAM	0383	DANSAI	0099
RFT	0455	SONOLOR	0190, 0235	WARDS	0057, 0081, 0205, 0893	DE GRAAF	0069
RADIOSHACK	0057, 0074, 0181, 0205, 0207	SONTEC	0064	WATSON	0064, 0347	DECCA	0027, 0108
RADIOLA	0064	SONY	0027, 0677, 0861, 1127, 1532, 1678	WAYCON	0183	DENON	0069
RADIOMARELLI	0543	SOUNDESIGN	0205, 0207	WHITE WESTINGHOUSE	0064, 0347, 0490, 0650	DUAL	0068
REALISTIC	0057, 0181, 0205, 0207	SOUNDWAVE	0064, 0445	YAMAHA	0057, 0172, 0677, 0796, 0860, 2900 (projector), 2901 (projector), 2903, 2904 (projector)	DUMONT	0027, 0108, 0131
REDIFFUSION	0388	SOWA	0078, 0087, 0119, 0183, 0205	YAPSHE	0277	DYNATECH	0027
REOC	0741	SQUAREVIEW	0198	YOKO	0064, 0291	ESC	0267, 0305
REVOX	0064	STANDARD	0036	ZENITH	0044, 0119, 0205, 0490	ELCATECH	0099
REX	0190, 0286, 0291	STARLITE	0207			ELECTROHOME	0064
ROADSTAR	0036, 0291, 0445	STERN	0190, 0286			ELECTROPHONIC	0064
RUNCO	0044, 0057, 0524, 0630	SUPREME	0027			EMEREX	0059
SBR	0064	SYLVANIA	0057, 0081, 0198			EMERSON	0027, 0062, 0064, 0070, 0072, 0211, 0267, 0305, 1305, 1506
SEG	0291, 0695	SYMPHONIC	0198, 0207			FERGUSON	0068, 0347
SEI	0543	SYNCO	0027, 0087, 0119, 0120, 0205, 0478			FIDELITY	0027
SKY	0064	SYSLINE	0064			FINLANDIA	0108, 0131
SSS	0207	T + A	0474			FINLUX	0027, 0069, 0108, 0131
SABA	0136, 0190, 0314, 0362	TCM	0835	VCR		FIRSTLINE	0064, 0070, 0072, 0099
SACCS	0265	TMK	0205	ASA	0064, 0108	FISHER	0074, 0131
SAGEM	0637	TNCI	0044	ADMIRAL	0075	FUJI	0060, 0062
SAISHO	0036, 0291, 0543	TVS	0490	ADVENTURA	0027	FUJITSU	0027, 0072
SALORA	0190, 0380, 0388, 0575	TACICO	0036, 0119, 0205	AIKO	0305	FUNAI	0027
SAMBERS	0543	TAI YI	0036	AIWA	0027, 0064, 0334, 0375, 0379	GE	0062, 0087, 0267, 0834, 1062, 1087
SAMPO	0036, 0057, 0119, 0120, 0181, 0198, 0205, 0677, 1782	TANDY	0120, 0190	AKAI	0068, 0342	GEC	0108
SAMSUNG	0036, 0057, 0064, 0087, 0117, 0119, 0181, 0205, 0291, 0397, 0583, 0614, 0645, 0729, 0793, 0839, 0841	TASHIKO	0119, 0677	AKIBA	0099	GARRARD	0027
SANSEI	0478	TATUNG	0036, 0064, 0078, 0081, 0087, 0181, 0183, 0543	ALBA	0099, 0305, 0342, 0379	GENERAL	0072
SANSUI	0490	TEAC	0036, 0064, 0291, 0439, 0445, 0482, 0695, 1064	AMERICA ACTION	0305	GO VIDEO	0459
SANYO	0131, 0181, 0207, 0235, 0366, 0826	TEC	0695, 1064	AMERICAN HIGH	0062	GOLDHAND	0099
SCHAUB LORENZ	0388	TECHNEMA	0347	AMSTRAD	0027	GOLDSTAR	0064, 0252, 0507, 1264
SCHNEIDER	0064, 0274, 0398, 0695	TECHNICS	0078, 0277, 0677	ANAM	0064, 0253, 0267, 0305, 0507	GOODMANS	0027, 0064, 0099, 0305
SCOTCH	0205	TECHWOOD	0078	ANAM NATIONAL	0253, 1589	GRADIENTE	0027
SCOTT	0205, 0207, 0263	TECO	0036, 0078, 0119, 0120, 0205, 0291, 0680	ANITECH	0099	GRAETZ	0068, 0131, 0267
SEARS	0074, 0081, 0181, 0183, 0198, 0205	TEKNIKA	0081, 0087, 0119, 0177, 0207	ASHA	0267	GRANADA	0108, 0131
SELECO	0190, 0286	TELEFUNKEN	0136, 0289, 0362, 0652, 0729	ASUKA	0064	GRANDIN	0027, 0064, 0099
		TELEMEISTER	0347	AUDIOVOX	0064, 0305	GRUNDIG	0099, 0108, 0253, 0374
		TELETECH	0036	BAIRD	0027, 0068, 0131	HCM	0099
		TENSAI	0347	BASIC LINE	0099, 0305	HI-Q	0074
		TERA	0057	BEAUMARK	0267	HANSEATIC	0064
		THOMSON	0136, 0314, 0587, 0652, 1474	BELL & HOWELL	0131	HARLEY DAVIDSON	0027
		THORN	0064, 0131, 0388, 0539	BLAUPUNKT	0253	HARMAN/KARDON	0108
		TOSHIBA	0087, 0181, 0183, 0535, 0645, 0677, 0859, 1283, 1383, 1683, 1731	BRANDT	0347	HARWOOD	0099
				BRANDT ELECTRONIC	0068	HINARI	0099, 0267, 0379
				BROKSONIC	0211, 0375, 1506	HITACHI	0027, 0064, 0068, 0069, 0267
				BUSH	0099, 0305, 0379		
				CCE	0099, 0305		
				CGE	0027		
				CALIX	0064		

HUGHES NETWORK SYSTEMS	MINOLTA	0069	RCA	0062, 0069, 0087,	SYLVANIA	0027, 0062, 0108,
0069	0068, 0070, 0094,		0267, 0834, 1062,	0070, 1808		
HYPSON	0108, 0834		1087		SYMPHONIC	0027
0099	MOTOROLA	0062, 0075	RADIOSHACK	0027	TMK	0267
ITT	0062, 0131, 0267		RADIOLA	0108	TANDY	0027, 0131
ITV	0064, 0305	MULTITECH	RADIX	0064	TASHIKO	0027, 0064
IMPERIAL	0027	MURPHY	RANDEX	0064	TATUNG	0027, 0068, 0072,
INTERFUNK	0108	MYRYAD	REALISTIC	0027, 0062, 0064,	0094, 0108	
JVC	0068, 0072, 0094	NAD	0074, 0075, 0131		TEAC	0027, 0068, 0305,
JENSEN	0068	NEC	0075, 0094, 0131	REOC	0375	0334, 0669
KEC	0064, 0305			REPLAYTV	0641, 0643	TECHNICS
KLH	0099	NATIONAL	0253	REX	0068	0062, 0253
KAISUI	0099	NECKERMANN	0108	ROADSTAR	0064, 0099, 0267,	TECO
KENWOOD	0068, 0094	NESCO	0099	0305		0075
KODAK	0062, 0064	NEWAVE	0064	RUNCO	0066	TEKNIKA
KOLIN	0068, 0070	NIKKO	0064	SBR	0108	0027, 0062, 0064
KORPEL	0099	NOBLEX	0267	SEG	0267	TELEAVIA
LG	0064, 0069, 0072,	NOKIA	0068, 0131, 0267	SEI	0108	0068
0507		NORDMENDE	0068, 0347	STS	0069	TELEFUNKEN
LXI	0064	OCEANIC	0027, 0068	SABA	0068, 0347	0068, 0347
LENCO	0305	OKANO	0342, 0375	SALORA	0070	TENOSAL
LEYCO	0099	OLYMPUS	0062, 0253	SAMPO	0064, 0075	0099
LLOYD'S	0027	OPTIMUS	0064, 0075, 0131,	SAMSUNG	0072, 0267, 0459	TENSAI
LOEWE	0064, 0108, 1589	0459		SANSKY	0066, 0075	0027
LOGIK	0099, 0267	ORION	0211, 0375, 0379,	SANSUI	0027, 0068, 0094,	THOMAS
LUXOR	0070, 0075, 0131	1506		1506		0068, 0087, 0094,
M ELECTRONIC		OSAKI	0027, 0064, 0099	SANYO	0074, 0131, 0267	0347
0027		OTTO VERSAND	0108	SAVILLE	0379	THORN
MEI	0062	PALLADIUM	0064, 0068, 0099	SCHAUB LORENZ	0027, 0068,	0068, 0131
MGA	0070, 0267	PANASONIC	0062, 0252, 0253,	0131		TIVO
MGN TECHNOLOGY		0643, 1062, 1589		SCHNEIDER	0027, 0099, 0108	0645, 0663
0267		PATHE MARCONI	0068	SCOTT	0070, 0072, 0211	0068, 0070, 0072,
MTC	0027, 0267	PENNEY	0062, 0064, 0069,	SEARS	0027, 0062, 0064,	0094, 0108, 0872
MAGNASONIC		0267, 1062, 1264		1264		0094, 0108, 0872
1305		PENTAX	0069	SELECO	0068	TOTEVISION
MAGNAVOX	0027, 0062, 0066,	PERDIO	0027	SEMP	0072	0064, 0267
0108, 1808		PHILCO	0062	SHARP	0075, 0834	UHER
MAGNIN	0267	PHILIPS	0062, 0108, 0645,	SHINTOM	0099, 0131	0267
MANESTH	0072, 0099	1108, 1208		SIEMENS	0064, 0108, 0131	0094, 0108, 0267
MARANTZ	0062, 0108	PHONOLA	0108	SILVA	0064	WHITE WESTINGHOUSE
MARTA	0064	PILOT	0064	SINGER	0072, 0099	0099
MATSUI	0375, 0379	PIONEER	0069, 0094, 0108	SINUDYNE	0108	XR-1000
MATSUSHITA		POLK AUDIO	0108	SONIC BLUE	0641, 0643	0027, 0062, 0099
0062		PROFITRONIC	0267	SONTEC	0064	YAMAHA
MEDION	0375	PROSCAN	0087, 1087	SONY	0027, 0059, 0060,	0068
MEMOREX	0027, 0062, 0064,	PROTEC	0099	SUNKAI	0062, 0663, 1259	0099
0066, 0074, 0075,		PYLSAR	0066	SUNSTAR	0027	0099
0131, 0267, 0334,		PYE	0108	SUNTRONIC	0027	0267
0375, 1264		QUASAR	0062, 1062			0027, 0060, 0066,
MEMPHIS	0099	QUELLE	0108			1506
METZ	0064, 0374, 1589					



© 2007 YAMAHA CORPORATION All rights reserved.

YAMAHA ELECTRONICS CORPORATION, USA 6660 ORANGETHORPE AVE., BUENA PARK, CALIF. 90620, U.S.A.
 YAMAHA CANADA MUSIC LTD. 135 MILNER AVE., SCARBOROUGH, ONTARIO M1S 3R1, CANADA
 YAMAHA ELECTRONIK EUROPA G.m.b.H. SIEMENSSTR. 22-34, 25462 RELINGEN BEI HAMBURG, GERMANY
 YAMAHA ELECTRONICS FRANCE S.A. RUE AMBROISE CROIZAT BP70 CROISSY-BEAUBOURG 77312 MARNE-LA-VALLEE CEDEX02. FRANCE
 YAMAHA ELECTRONICS (UK) LTD. YAMAHA HOUSE, 200 RICKMANSWORTH ROAD WATFORD, HERTS WD18 7GQ, ENGLAND
 YAMAHA SCANDINAVIA A.B. J A WETTERGRENS GATA 1, BOX 30053, 400 43 VÄSTRA FRÖLUNDA, SWEDEN
 YAMAHA MUSIC AUSTRALIA PTY, LTD. 17-33 MARKET ST., SOUTH MELBOURNE, 3205 VIC., AUSTRALIA

YAMAHA CORPORATION
 Printed in Malaysia  WJ70020

The circled numbers and alphabets correspond to those in the Owner's Manual.

Les nombres et lettres dans un cercle correspondent à ceux du mode d'emploi.

Die umkreisten Zahlen und Buchstaben entsprechen denen in der Bedienungsanleitung.

Inringade nummer och bokstäver motsvarar de som anges i bruksanvisningen.

De omcirkelde cijfers en letters corresponderen met die in de Gebruiksaanwijzing.

Цифры и буквы в кружках относятся к цифрам и буквам в Инструкции по эксплуатации.

■ Front panel/Face avant/Frontblende/Frontpanelen/Voorpaneel/Фронтальная панель

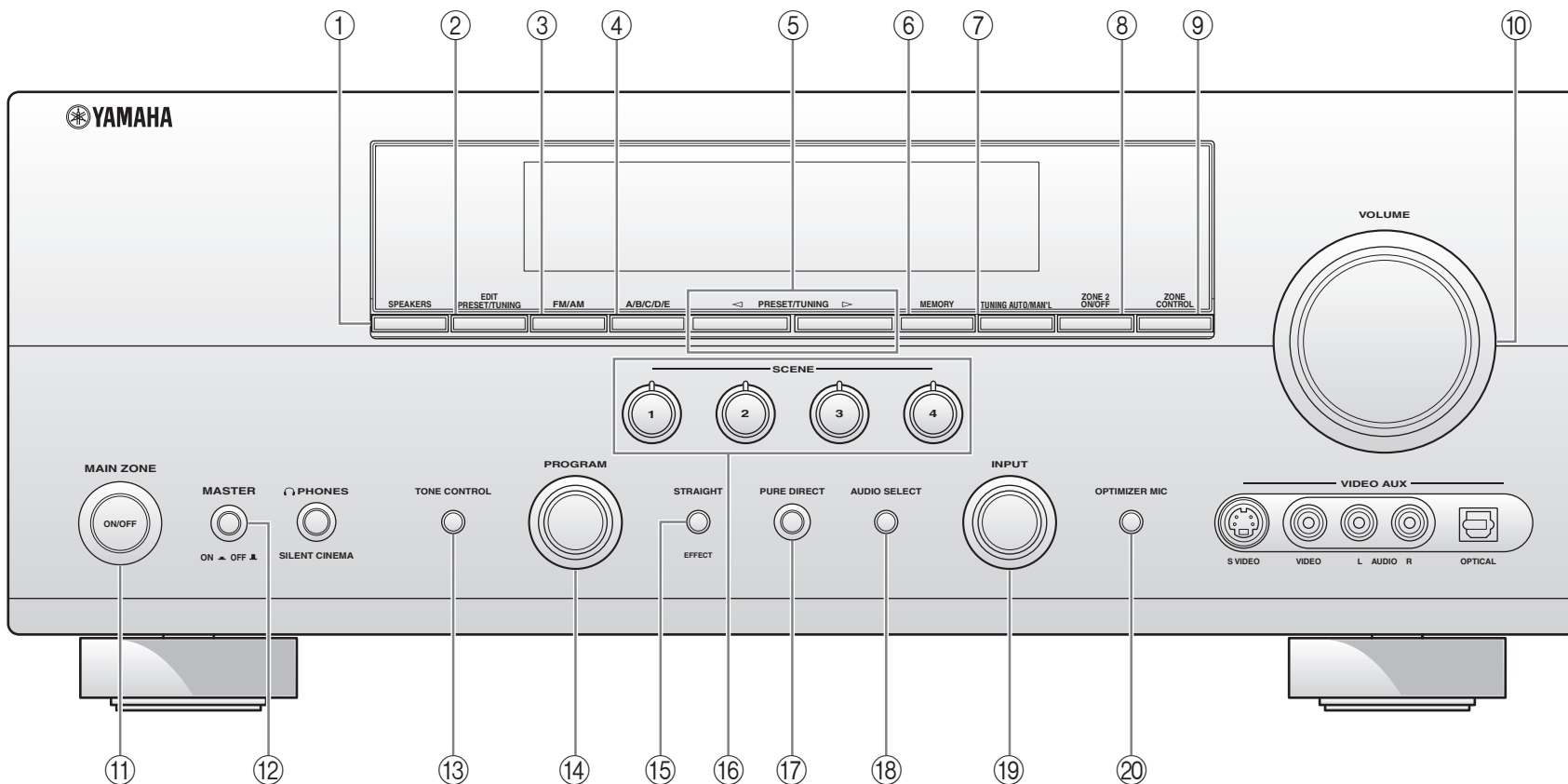

Remote control/Boîtier de télécommande/Fernbedienung/Fjärrkontrollen/ Afstandsbediening/Пульт ДУ

