



UB

YST-FSW150/ YST-FSW050

SUBWOOFER SYSTEM



OWNER'S MANUAL

IMPORTANT SAFETY INSTRUCTIONS

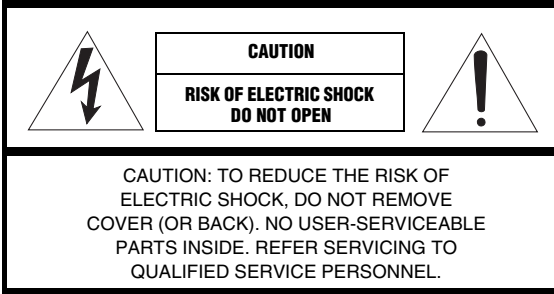

• Explanation of Graphical Symbols

The lightning flash with arrowhead symbol, within an equilateral triangle, is intended to alert you to the presence of uninsulated "dangerous voltage" within the product's enclosure that may be of sufficient magnitude to constitute a risk of electric shock to persons.

The exclamation point within an equilateral triangle is intended to alert you to the presence of important operating and maintenance (servicing) instructions in the literature accompanying the appliance.

IMPORTANT

Please record the serial number of this unit in the space below.

MODEL:

Serial No.:

The serial number is located on the rear of the unit. Retain this Owner's Manual in a safe place for future reference.

WARNING

TO REDUCE THE RISK OF FIRE OR ELECTRIC SHOCK, DO NOT EXPOSE THIS UNIT TO RAIN OR MOISTURE.

- 1 Read these instructions.
- 2 Keep these instructions.
- 3 Heed all warnings.
- 4 Follow all instructions.
- 5 Do not use this apparatus near water.
- 6 Clean only with dry cloth.
- 7 Do not block any ventilation openings. Install in accordance with the manufacturer's instructions.
- 8 Do not install near any heat sources such as radiators, heat registers, stoves, or other apparatus (including amplifiers) that produce heat.
- 9 Do not defeat the safety purpose of the polarized or grounding-type plug. A polarized plug has two blades with one wider than the other. A grounding type plug has two blades and a third grounding prong. The wide blade or the third prong are provided for your safety. If the provided plug does not fit into your outlet, consult an electrician for replacement of the obsolete outlet.
- 10 Protect the power cord from being walked on or pinched particularly at plugs, convenience receptacles, and the point where they exit from the apparatus.
- 11 Only use attachments/accessories specified by the manufacturer.
- 12 Use only with the cart, stand, tripod, bracket, or table specified by the manufacturer, or sold with the apparatus. When a cart is used, use caution when moving the cart/apparatus combination to avoid injury from tip-over.
- 13 Unplug this apparatus during lightning storms or when unused for long periods of time.
- 14 Refer all servicing to qualified service personnel. Servicing is required when the apparatus has been damaged in any way, such as power-supply cord or plug is damaged, liquid has been spilled or objects have fallen into the apparatus, the apparatus has been exposed to rain or moisture, does not operate normally, or has been dropped.



For U.K. customers

If the socket outlets in the home are not suitable for the plug supplied with this appliance, it should be cut off and an appropriate 3 pin plug fitted. For details, refer to the instructions described below.

Note

The plug severed from the mains lead must be destroyed, as a plug with bared flexible cord is hazardous if engaged in a live socket outlet.

Special Instructions for U.K. Model

IMPORTANT

THE WIRES IN MAINS LEAD ARE COLOURED IN ACCORDANCE WITH THE FOLLOWING CODE:

Blue: NEUTRAL

Brown: LIVE

As the colours of the wires in the mains lead of this apparatus may not correspond with the coloured markings identifying the terminals in your plug, proceed as follows: The wire which is coloured BLUE must be connected to the terminal which is marked with the letter N or coloured BLACK. The wire which is coloured BROWN must be connected to the terminal which is marked with the letter L or coloured RED.

Make sure that neither core is connected to the earth terminal of the three pin plug.

FCC INFORMATION (for US customers)

1 IMPORTANT NOTICE: DO NOT MODIFY THIS UNIT!

This product, when installed as indicated in the instructions contained in this manual, meets FCC requirements. Modifications not expressly approved by Yamaha may void your authority, granted by the FCC, to use the product.

2 IMPORTANT: When connecting this product to accessories and/or another product use only high quality shielded cables. Cable/s supplied with this product MUST be used. Follow all installation instructions. Failure to follow instructions could void your FCC authorization to use this product in the USA.

3 NOTE: This product has been tested and found to comply with the requirements listed in FCC Regulations, Part 15 for Class "B" digital devices. Compliance with these requirements provides a reasonable level of assurance that your use of this product in a residential environment will not result in harmful interference with other electronic devices.

This equipment generates/uses radio frequencies and, if not installed and used according to the instructions found in the users manual, may cause interference harmful to the operation of other electronic devices.

Compliance with FCC regulations does not guarantee that interference will not occur in all installations. If this product is found to be the source of interference, which can be determined by turning the unit "OFF" and "ON", please try to eliminate the problem by using one of the following measures:

Relocate either this product or the device that is being affected by the interference.

Utilize power outlets that are on different branch (circuit breaker or fuse) circuits or install AC line filter/s.

In the case of radio or TV interference, relocate/reorient the antenna. If the antenna lead-in is 300 ohm ribbon lead, change the lead-in to coaxial type cable.

If these corrective measures do not produce satisfactory results, please contact the local retailer authorized to distribute this type of product. If you can not locate the appropriate retailer, please contact Yamaha Electronics Corp., U.S.A. 6660 Orangethorpe Ave, Buena Park, CA 90620.

The above statements apply ONLY to those products distributed by Yamaha Corporation of America or its subsidiaries.

We Want You Listening For A Lifetime

Yamaha and the Electronic Industries Association's Consumer Electronics Group want you to get the most out of your equipment by playing it at a safe level. One that lets the sound come through loud and clear without annoying blaring or distortion – and, most importantly, without affecting your sensitive hearing. Since hearing damage from loud sounds is often undetectable until it is too late, Yamaha and the Electronic Industries Association's Consumer Electronics Group recommend you to avoid prolonged exposure from excessive volume levels.



Limited Guarantee for European Economic Area (EEA) and Switzerland

Thank you for having chosen a Yamaha product. In the unlikely event that your Yamaha product needs guarantee service, please contact the dealer from whom it was purchased. If you experience any difficulty, please contact Yamaha representative office in your country. You can find full details on our website (<http://www.yamaha-hifi.com/> or <http://www.yamaha-uk.com/> for U.K. resident).

The product is guaranteed to be free from defects in workmanship or materials for a period of two years from the date of the original purchase. Yamaha undertakes, subject to the conditions listed below, to have the faulty product or any part(s) repaired, or replaced at Yamaha's discretion, without any charge for parts or labour. Yamaha reserves the right to replace a product with that of a similar kind and/or value and condition, where a model has been discontinued or is considered uneconomic to repair.

Conditions

1. The original invoice or sales receipt (showing date of purchase, product code and dealer's name) MUST accompany the defective product, along with a statement detailing the fault. In the absence of this clear proof of purchase, Yamaha reserves the right to refuse to provide free of charge service and the product may be returned at the customer's expense.
2. The product MUST have been purchased from an AUTHORISED Yamaha dealer within the European Economic Area (EEA) or Switzerland.
3. The product must not have been the subject of any modifications or alterations, unless authorised in writing by Yamaha.
4. The following are excluded from this guarantee:
 - a. Periodic maintenance and repair or replacement of parts due to normal wear and tear.
 - b. Damage resulting from:
 - (1) Repairs performed by the customer himself or by an unauthorised third party.
 - (2) Inadequate packaging or mishandling, when the product is in transit from the customer. Please note that it is the customer's responsibility to ensure the product is adequately packaged when returning the product for repair.
 - (3) Misuse, including but not limited to (a) failure to use the product for its normal purpose or in accordance with Yamaha's instructions on the proper use, maintenance and storage, and (b) installation or use of the product in a manner inconsistent with the technical or safety standards in the country where it is used.
 - (4) Accidents, lightning, water, fire, improper ventilation, battery leakage or any cause beyond Yamaha's control.
 - (5) Defects of the system into which this product is incorporated and/or incompatibility with third party products.
 - (6) Use of a product imported into the EEA and/or Switzerland, not by Yamaha, where that product does not conform to the technical or safety standards of the country of use and/or to the standard specification of a product sold by Yamaha in the EEA and/or Switzerland.
 - (7) Non AV (Audio Visual) related products.
(Products subject to "Yamaha AV Guarantee Statement" are defined in our website at <http://www.yamaha-hifi.com/> or <http://www.yamaha-uk.com/> for U.K. resident.)
5. Where the guarantee differs between the country of purchase and the country of use of the product, the guarantee of the country of use shall apply.
6. Yamaha may not be held responsible for any losses or damages, whether direct, consequential or otherwise, save for the repair or replacement of the product.
7. Please backup any custom settings or data, as Yamaha may not be held responsible for any alteration or loss to such settings or data.
8. This guarantee does not affect the consumer's statutory rights under applicable national laws in force or the consumer's rights against the dealer arising from their sales/purchase contract.

Thank you for selecting this Yamaha subwoofer system.

CAUTION: Read this before operating your unit.

Please read the following operating precautions before use.

Yamaha will not be held responsible for any damage and/or injury caused by not following the cautions below.

- 1 To assure the finest performance, please read this manual carefully. Keep it in a safe place for future reference.
- 2 Install this unit in a cool, dry, clean place - away from windows, heat sources, sources of excessive vibration, dust, moisture and cold. Avoid sources of humming (transformers, motors).
- 3 Never open the cabinet. If something drops into the set, contact your dealer.
- 4 The voltage to be used must be the same as that specified on the rear panel. Using this unit with a higher voltage than specified is dangerous and may cause a fire and/or electric shock.
- 5 To reduce the risk of fire or electric shock, do not expose this unit to rain or moisture.
- 6 Do not use force on switches, controls or connection wires. When moving the unit, first disconnect the power plug and the wires connected to other equipment. Never pull the wires themselves.
- 7 When not planning to use this unit for a long period (i.e., vacation, etc.), disconnect the AC power plug from the wall outlet.
- 8 Since this unit has a built-in power amplifier, heat will radiate from the bottom panel. Place the unit apart from the walls to prevent fire or damage. Allow ventilation space of at least 10 cm on the top, 20 cm on the left and right, and 20 cm on the back of this unit.
- 9 Do not cover this unit with a newspaper, a tablecloth, a curtain, etc. in order not to obstruct heat radiation. If the temperature inside the unit rises, it may cause fire, damage to the unit and/or personal injury.
- 10 Do not place the following objects on this unit:
 - Glass, china, small metallic etc.
If glass etc. falls by vibrations and breaks, it may cause bodily injury.
 - A burning candle etc.
If the candle falls by vibrations, it may cause fire and bodily injury.
 - A vessel with water in it
If the vessel falls by vibrations and water spills, it may cause damage to the speaker, and/or you may get an electric shock.
- 11 Do not place this unit where foreign objects such as water drips might fall. It might cause a fire, damage to this unit, and/or personal injury.
- 12 Never put a hand or a foreign object into the YST port located on the front side of this unit. When moving this unit, do not hold the port as it might cause personal injury and/or damage to this unit.
- 13 Never place a fragile object near the YST port of this unit. If the object falls or drops by the air pressure, it may cause damage to the unit and/or personal injury.
- 14 Never open the cabinet. It might cause an electric shock since this unit uses a high voltage. It might also cause personal injury and/or damage to this unit.
- 15 When using a humidifier, be sure to avoid condensation inside this unit by allowing enough spaces around this unit or avoiding excess humidification. Condensation might cause a fire, damage to this unit, and/or electric shock.
- 16 Super-bass frequencies reproduced by this unit may cause a turntable to generate a howling sound. In such a case, move this unit away from the turntable.
- 17 This unit may be damaged if certain sounds are continuously output at high volume level. For example, if 20 Hz-50 Hz sine waves from a test disc, bass sounds from electronic instruments, etc. are continuously output, or when the stylus of a turntable touches the surface of a disc, reduce the volume level to prevent this unit from being damaged.
- 18 If you hear distorted noise (i.e., unnatural, intermittent “rapping” or “hammering” sounds) coming from this unit, reduce the volume level. Extremely loud playing of a movie soundtrack’s low frequency, bass-heavy sounds or similarly loud popular music passages can damage this speaker system.
- 19 Vibration generated by super-bass frequencies may distort images on a TV. In such a case, move this unit away from the TV set.
- 20 Do not attempt to clean this unit with chemical solvents as this might damage the finish. Use a clean, dry cloth.
- 21 Be sure to read the “Troubleshooting” section regarding common operating errors before concluding that the unit is faulty.
- 22 Install this unit near the wall outlet and where the AC power plug can be reached easily.
- 23 **VOLTAGE SELECTOR**
(For Asia and General models)
The voltage selector switch on the bottom panel of this unit must be set for your local main voltage BEFORE plugging this unit into the AC main supply. Voltages are:
110–120/220–240 V AC, 50/60 Hz.
- 24 **Secure placement or installation is the owner’s responsibility. Yamaha shall not be liable for any accident caused by improper placement or installation of speakers.**

This unit features a magnetically shielded design, but there is still a chance that placing it too close to a TV set might impair picture color. Should this happen, move this unit away from the TV set.

This unit is not disconnected from the AC power source as long as it is connected to the wall outlet, even if this unit itself is turned off. In this state, this unit is designed to consume a very small quantity of power.

FOR CANADIAN CUSTOMERS

To prevent electric shock, match wide blade of plug to wide slot and fully insert.

This Class B digital apparatus complies with Canadian ICES-003.

POUR LES CONSOMMATEURS CANADIENS

Pour éviter les chocs électriques, introduire la lame la plus large de la fiche dans la borne correspondante de la prise et pousser jusqu’au fond.

Cet appareil numérique de la classe B est conforme à la norme NMB-003 du Canada.

Table of contents

IMPORTANT SAFETY INSTRUCTIONS	i
CAUTION: Read this before operating your unit	iii
Getting started	1
Placement	2
Connections	3
Using the subwoofer	5
Advanced Yamaha Active Servo Technology II	6
Troubleshooting	7
Specifications	Back cover

Getting started

Features

- This subwoofer system employs Advanced Yamaha Active Servo Technology II, which Yamaha has developed to reproduce higher quality super-bass sound (see “Advanced Yamaha Active Servo Technology II” on page 6 for details). This super-bass sound adds a more realistic, theater-in-the-home effect to your stereo system.
- Yamaha’s unique and compact design let you place this unit horizontally.

Supplied accessories

Please confirm that the following items are included in the package.

Subwoofer cable (5 m)

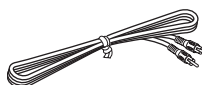

**Non-skid pad
(1 set, 4 pieces)**



System control cable (5 m)

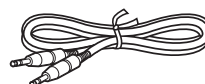

Stand (YST-FSW150 only)

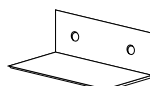

**Screw
(M4, 16 mm) x 2
(YST-FSW150 only)**



Placement

The following illustrations are the setting images of this unit.

Example 1: Using this unit with Yamaha Digital Sound Projector

Yamaha Digital Sound Projector

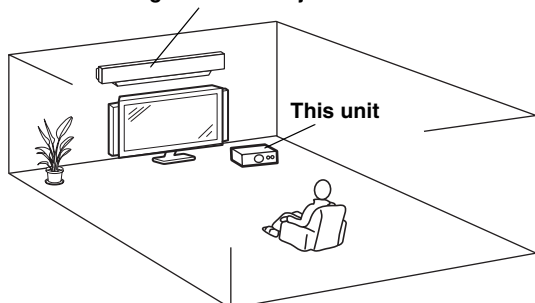

Example 2: As a part of multi channel speaker system

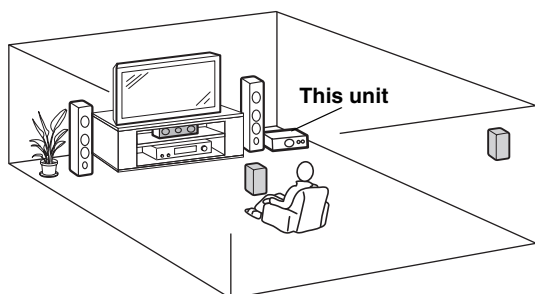

Notes

- Do not place this unit on/under any other components in a pile. The vibration of this unit may cause system failure, etc. in other components.
- Keep enough ventilation space on the front, the rear, and the bottom side (that attached feet) of this unit. Do not place this unit on a thick carpet etc.

Tip

You can also place this unit vertically.

When you want to do so, fix a stand using the supplied screws (YST-FSW150 only) and then attach pads as shown below.

Note

When placing this unit vertically, set the bottom side (that attached feet) of this unit toward a wall.

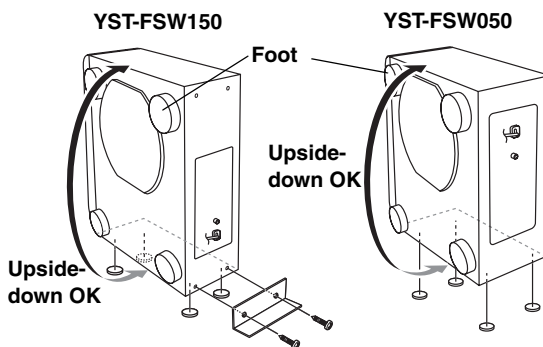

Tip

You can also place this unit in a TV rack etc.

Note

If vibrations of this unit cause abnormal noise or sympathetic vibrations on nearby components, attach the supplied non-skid pads to the bottoms of the feet.

Bottom view (example: YST-FSW150)

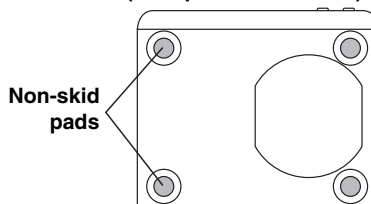

Connections

Caution: Do not plug the power cables of the subwoofer and other audio/video components into an AC outlet until you complete all the other connections.

Basic connection example

Connect the subwoofer cable to the output jack of your AV amplifier, receiver or TV and to the **INPUT** jack of the subwoofer.

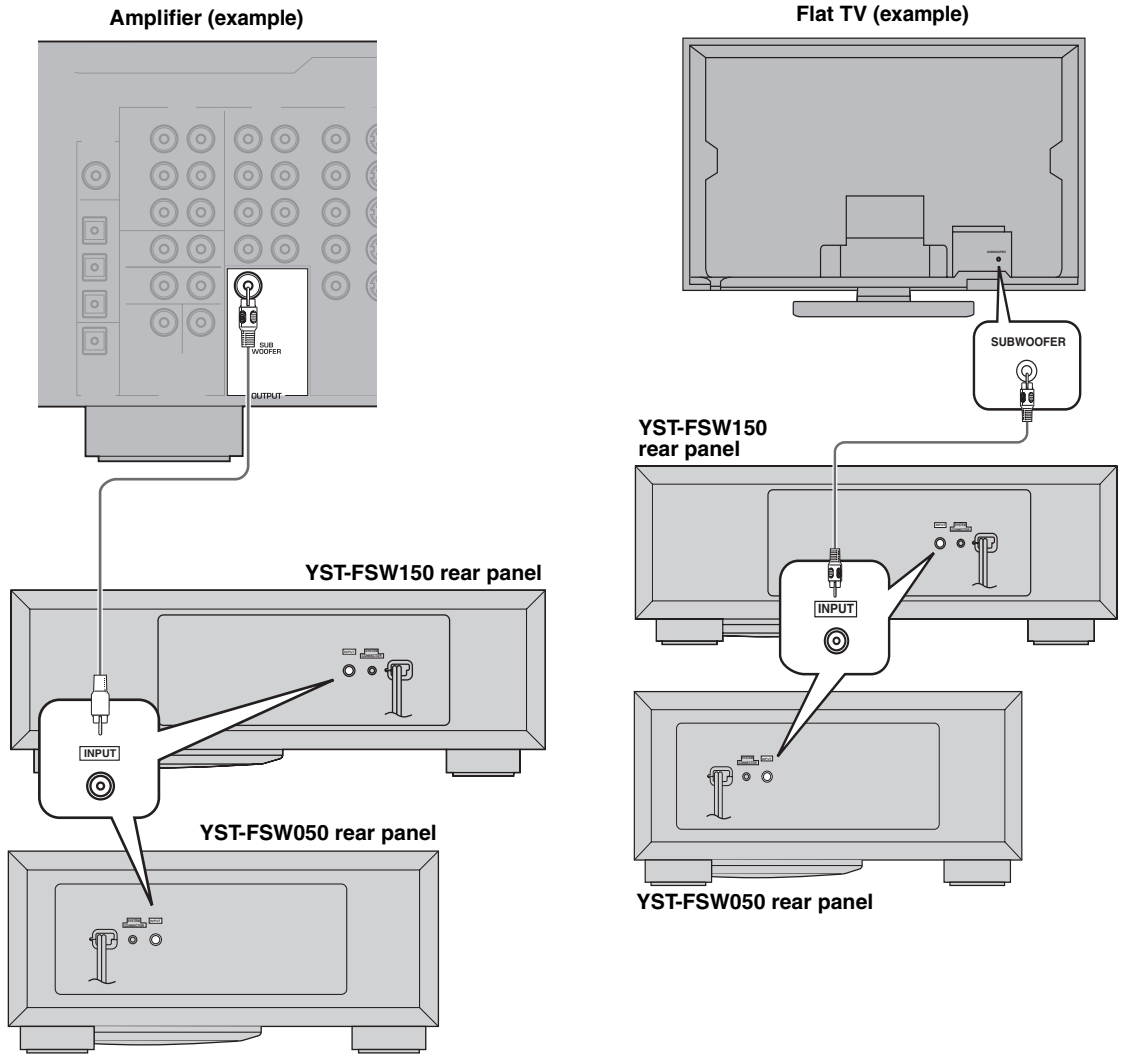

The system connection

This unit has a SYSTEM CONNECTOR jack. Use the supplied system control cable when connecting a Yamaha component equipped with a system connector jack. When connected, the power mode (**ON, OFF/SYSTEM**) of this unit can be controlled with the power button of the connected Yamaha component.

Notes

- Set the **POWER** button of this unit to **OFF/SYSTEM**. The power of this unit can be turned on even when the **POWER** button is set to **OFF/SYSTEM**.
- When the **POWER** button of this unit is set to **ON**, the connected component will not control the power mode of this unit, even though they are connected via a system connection. The power mode of this unit will always be **ON**.
- When this unit does not output low frequency signals even if you use the system connection, you need to change the setting of the connected component. For details, refer to the manual of the component.

Yamaha Digital Sound Projector (example)

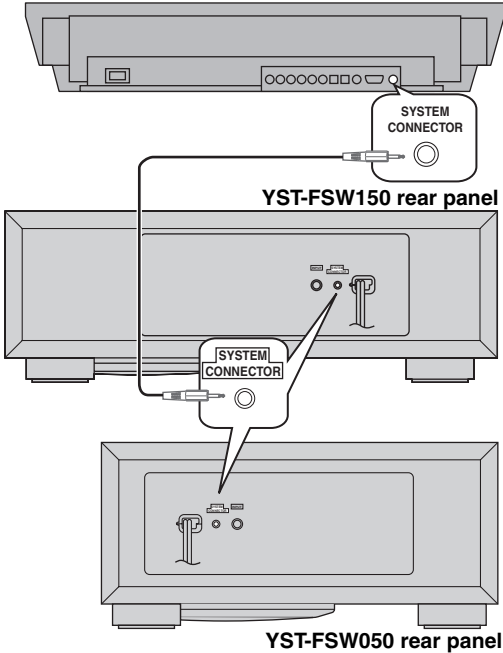

Connecting the components and the subwoofer to the AC power

After you complete a subwoofer connection, plug the amplifier, TV and/or other audio/video components, and the subwoofer into an AC outlet of appropriate voltage.

YST-FSW150 rear panel

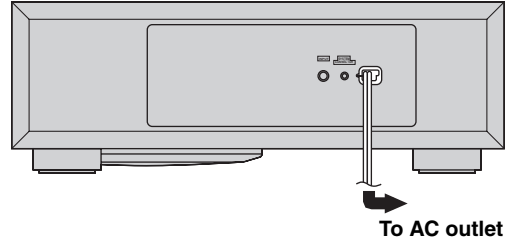

YST-FSW050 rear panel

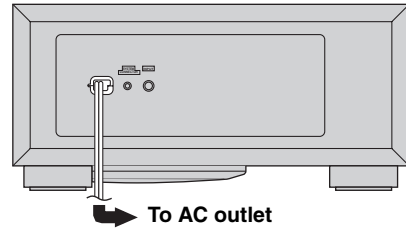

VOLTAGE SELECTOR

(For Asia and General models only)

The voltage selector switch on the bottom panel of this unit must be set for your local main voltage **BEFORE** plugging this unit into the AC main supply.

Voltages are 110–120/220–240 V AC, 50/60 Hz.

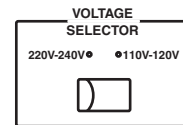

Using the subwoofer

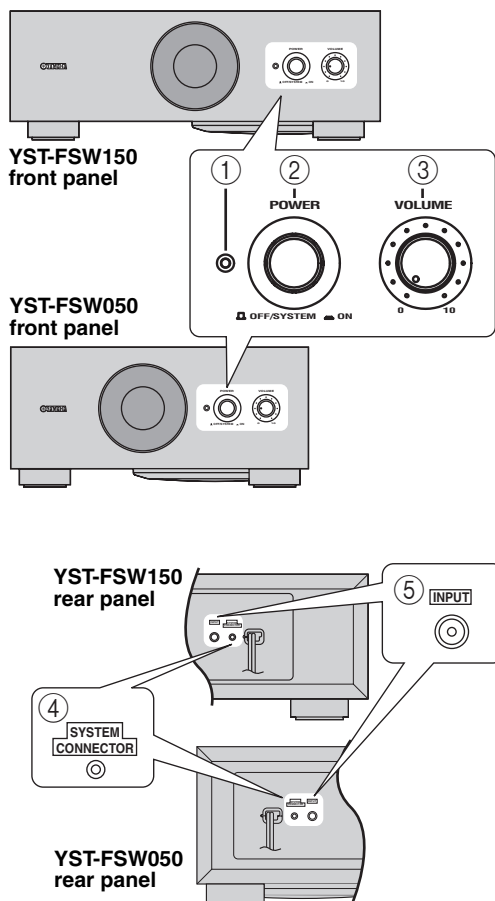

① Power indicator

Lights up green while the unit is turned on.

② POWER button

Press this button to the **ON** position to turn on the power of the subwoofer. Press this button to the **OFF/SYSTEM** position to turn off the power of the subwoofer or to use the system connection (see page 4).

③ VOLUME control

Adjusts the volume level. Turn the control clockwise to increase the volume, and counterclockwise to decrease the volume.

④ SYSTEM CONNECTOR terminal

Used for system connection. See “The system connection” on page 4 for details.

⑤ INPUT terminal

Input terminal for line level signals from the amplifier.

Pre-adjusting the subwoofer volume

Before you use the subwoofer, first adjust the volume balance between the subwoofer and the front speakers according to the procedure below.

1. Set the **VOLUME** control to minimum (0).
2. Turn on the power of all the other components.
3. Press the **POWER** button to the **ON** position.
Turn on the power switch of the connected component when the subwoofer is connected using the system connection.
4. Play a source that contains low-frequency sounds. Adjust the amplifier's volume control to the desired level.
5. Increase the volume gradually to adjust the volume balance between the subwoofer and the front speakers.
To enjoy natural bass sound, keep the subwoofer volume at a level where it is barely distinguishable from other speakers.
6. Adjust the volume of the entire sound system using the amplifier's volume control.

☼ Tip

It is recommended to set the **VOLUME** control about in the middle position when using in a multi channel home theater system.



Advanced Yamaha Active Servo Technology II

In 1998, Yamaha brought to the marketplace speaker systems utilizing YST (Yamaha Active Servo Technology) to give powerful, high quality bass reproduction. This technique uses a direct connection between the amplifier and speaker, allowing accurate signal transmission and precise speaker control.

As this technology uses speaker units controlled by the negative impedance drive of the amplifier and resonance generated between the speaker cabinet volume and port, it creates more resonant energy (the “air woofer” concept) than the standard bass

reflex method. This allows for bass reproduction from much smaller cabinets than was previously possible.

Yamaha’s newly developed Advanced YST II, with many refinements to Yamaha Active Servo Technology, allows better control of the forces driving the amplifier and speakers. From the amplifier’s point of view, the speaker impedance changes depending on the sound frequency. Yamaha developed a new circuit design combining negative-impedance and constant-current drives, which provides a more stable performance and clear bass reproduction with less murkiness.

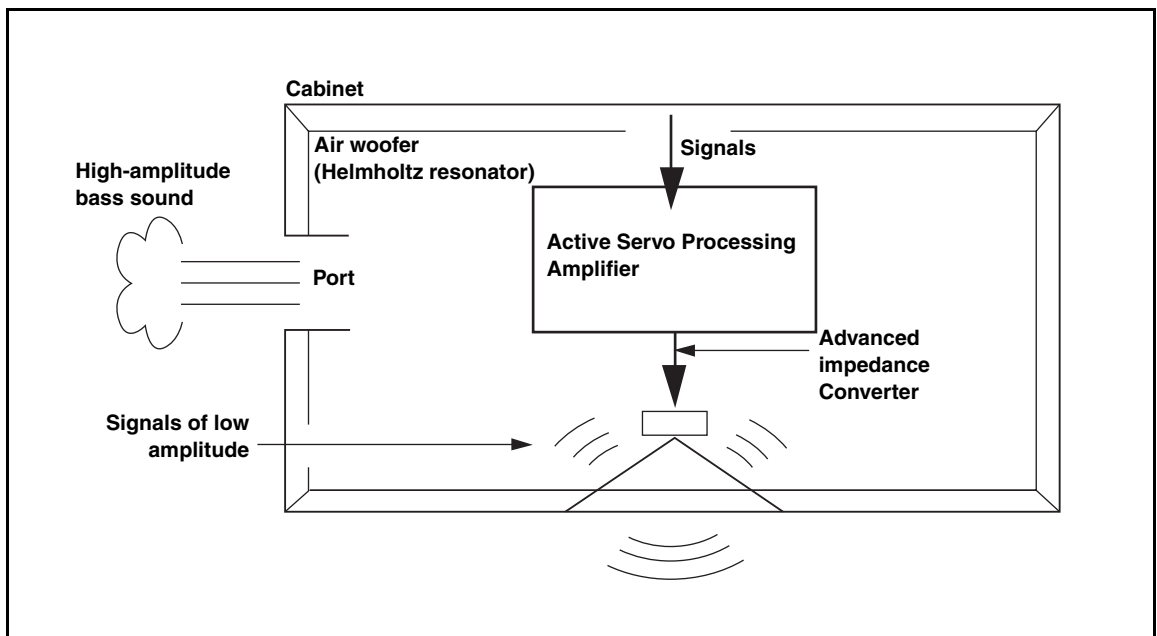

Troubleshooting

Refer to the chart below if the unit does not function properly. If the problem you are experiencing is not listed, or if the instructions fail to help you resolve the problem, disconnect the power cable and contact your authorized Yamaha dealer or service center.

Problem	Cause	Remedy
Power is not supplied even though the POWER button is set to the ON position.	The power plug is not securely connected.	Turn the POWER button to OFF/SYSTEM , and then connect the power plug securely.
No sound.	The VOLUME control is set to (0).	Turn up the volume.
	A subwoofer cable is not connected securely.	Connect a subwoofer cable securely.
Sound level is too low.	You are playing a sound source that includes inadequate bass frequencies.	Play a sound source that includes more bass frequencies.
	The sound level has been diminished by standing waves.	Reposition the subwoofer, or break up the parallel wall surface by placing bookshelves or other large objects along the wall.
	The input signal is too small.	Turn up the volume.
	No signal from the subwoofer output terminal of the component.	Check the speaker mode setting on the component.

Specifications

Type Advanced Yamaha Active Servo Technology II

Driver 16 cm (6-5/16")
Magnetically shielded type

Output Power

YST-FSW150 75 W (5 Ω, 10% T.H.D.)
YST-FSW050 50 W (5 Ω, 10% T.H.D.)

Dynamic Power

YST-FSW150 130 W, 5 Ω
YST-FSW050 100 W, 5 Ω

Input Impedance 12 kΩ

Frequency Response

YST-FSW150 30 Hz – 160 Hz
YST-FSW050 35 Hz – 160 Hz

Input Sensitivity

YST-FSW150 100 mV (50 Hz, 75 W/5 Ω)
YST-FSW050 50 mV (50 Hz, 50 W/5 Ω)

Power Supply

[U.S.A. and Canada models]..... AC 120 V, 60 Hz
[Australia model] AC 240 V, 50 Hz
[China model] AC 220 V, 50 Hz
[Korea model] AC 220 V, 60 Hz
[U.K. and Europe models] AC 230 V, 50 Hz
[Asia and General models]
..... AC 110–120/220–240 V, 50/60 Hz

Power Consumption

YST-FSW150 70 W
YST-FSW050 40 W

Dimensions (W x H x D)

YST-FSW150 435 mm x 151 mm x 350 mm
(17-2/16 in x 5-15/16 in x 13-12/16 in)
YST-FSW050 350 mm x 163 mm x 350 mm
(13-12/16 in x 6-7/16 in x 13-12/16 in)

Weight

YST-FSW150 9.4 kg (20 lbs. 12 oz.)
YST-FSW050 8.5 kg (18 lbs. 12 oz.)

Specifications are subject to change without notice.

Frequency characteristics

YST-FSW150

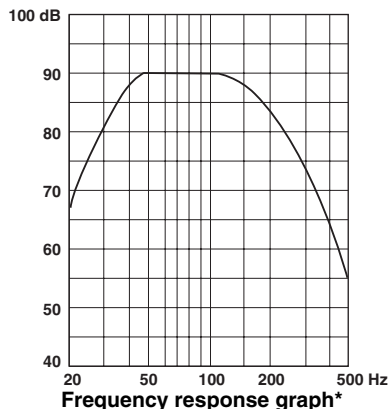

YST-FSW050

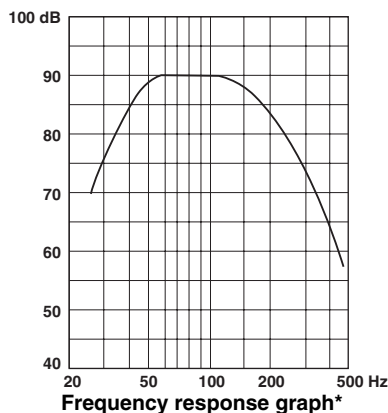

*This diagram does not depict actual frequency response characteristics accurately.



This symbol mark is according to the EU directive 2002/96/EC.

This symbol mark means that electrical and electronic equipment, at their end-of-life, should be disposed of separately from your household waste. Please act according to your local rules and do not dispose of your old products with your normal household waste.